

The Do It Yourself Archery Equipment Page

Greetings, in the following pages you will find an ever growing list of DIY projects (hence the name of those pages) where you can learn to make your own gear.

Why you ask, would someone want to do that when most of it can be bought redimade? Well there are many reasons, for me there is the drive to discover new things, the desire to learn how to make my own tackle and most importantly I am cheap.

Making your own stuff can and will save you money at the expense of your time but if you mind that then you need to find another hobby. In many of these pages you will find good simple instructions based on a many years of practice and research, not all of it mine as you will see.

I also had other reasons for making these pages, after having seen the quality of information on traditional or medieval archery out on the net I have come to the conclusion that it is in many cases poorly written, explained, photographed or so scattered as to be almost impossible to make use of.

I have tried to sift through it all as best I can looking for the information you will need and then bring it together here in a clear and simple to follow style.

Not to mention that much of the tools and supplies that we need are way over priced. I believe we are being gouged rather badly for everything. I mean \$125 U.S. beanies for a spine jig? Give me a break, I can make one for less than a fifth of the price and it will do a quite nice job thank you very much. Living in Canada makes it that much worse as everything is at least 50% more expensive than in the states, Oftentimes it is worse.

A large part of my archery is done as a member of a medieval archery company in the [SCA](#), the Society for Creative Anachronism. We try to recreate the middle ages as it should have been which means learning how it was done without modern tools, materials and/or techniques and very few folks die of the flu or sword wounds. To this end I like to try and strive for some measure of "periodness" in what I make, whether it be archery gear or clothes or my personal mannerisms.

For those of you interested in DIY archery projects, we have for your reading pleasure:

Useful Topics for Scadian or traditional Archers

- **Arrows**

- [Making basic wood arrows \(The decisions made first\)](#)
 - [The shafts](#)
 - [The feathers](#)
 - [The ends](#)
 - [The fit 'n finish](#)
- [How to straighten wood arrows](#)
- [How to make a matched set of arrows](#)
- [How to make an arrow diptank for cheap](#)

- **Strings**

- [Flemish braid string making](#)
 - [How to braide more than 2 bundles into your bowstring.](#)
- [Tied on string nocks](#)
- [Tieing a timber hitch](#)

- **Miscelaneous**

- [Making a back quiver](#)

- **DIY Supplies Link Page**

- [Links](#)

© 1999 Renny-James Bachner. All rights reserved. [suggestions and submissions](#)



Making basic SCA legal Arrows for the tyro

Written by RJ Bachner

- [The Decisions.](#)
- [The Shafts.](#)
- [The Feathers.](#)
- [The Nocks and Points.](#)
- [The Finish and Assembly.](#)

Part 1: Decisions, decisions.

So you want to make some arrows for SCA target archery? Cool, Well this is the place to learn. First I would like to cover some topics for sake of clarity, then I would like to explain the process to follow long before you get to laying hands to wood. Heck, this should be decided before you have even ordered your fixings.

Hopefully this will allow you to make the right decisions now and avoid mistakes later on.

1. The arrows I will describe here will be for target archery, not combat archery and I do not recommend you use them for hunting as they needs must achieve different goals, one will not suffice for the other.
2. The Arrows I will teach you about are what I will call Modern Traditional. I will leave the strictly period for another time. Feel free to experiment but here, our goal is to get you shooting with a minimum of muss, fuss and delay.

Ok. Arrows, right, well first you need to make some decisions about the arrows you want to make, and my instructions require that we are all saying the same thing so I will define certain terms, including:

- How Much you can afford to spend.
- Where you live.
- What kind of Bow do you use.
- Spine weight.
- Draw length.
- Arrow weight.
- What wood you want for the shaft.
- What will be your color scheme.
- What kind and style of fletching you want.
- What Kind of nock you like.

- Why you do not want to make hunting arrows for SCA target archery.

At this point I would like to explain some basic terms here that you are going to need soon, so bear with me:

- Draw weight: When you pick up a bow, hold it properly and pull the string back to your jaw, you are holding the draw weight of the bow. It is the amount of force required to hold the bow at full draw and is the amount of force momentarily applied to the arrow while launching it down range.
- Spine weight: This is the measure of stiffness of an arrow, roughly equated to the Draw weight of the bow. Generally a draw weight of 50lbs requires a spine of 50 lbs. The physics is some what complicated and I won't bore you with details.
- Cast: The distance a bow can fling an arrow. Each bow is different, cast is as much a measure of a bow's efficiency as it is about draw weight. Recurves are generally more efficient than longbows of equal draw weight and therefore usually have a better cast.
- Parallax: On certain types of bows, most longbows for example, there is no shelf or a minimal one which forces the arrow to rest against the side of the bow, slightly away from the centerline of the bow. This measure of how far the arrow is from the centerline is Parallax. Parallax forces you to shoot around the bow, making the arrow bend rather than a center shot bow which allows the arrow to fly though the centerline.
- Center shot: This means that the bow is designed so that the arrow can fly through the centerline of the bow, That mythical centerline that intersects the bow from center of one nock through the center of the other. This requires a shelf cut into the riser that is deep enough to cross the center line by at least half the width of an arrow.
- Arrow mass weight: An arrow's mass weight is an important factor for a number of reasons, such as it's function in resisting the initial push of the bow against the arrow which affects the bows efficiency and arrow speed. The lower the weight, the faster the arrow is accelerated but this is not always the most efficient use of the bow and the limbs may be required to absorb a good deal of the available energy. A heavy arrow takes more force to move and therefore is easier on the bow but is slower moving. Compromise is what is needed here and that depends on the task at hand.

A good rule of thumb is draw weight + a zero is a good arrow weight for general use. a 42 lb bow shoots a 420 grain arrow most efficiently. usually. This can be taken to extremes of course and you have to experiment to see what works best.

How much can you afford to spend and where do you live?

Ok this is the first thing you need to consider, what will this cost you? A dozen redimade arrows purchased from an American fletcher will run you from +/- \$30 to over a \$100 in US Funds.

We Canadians cringe every time we even think of ordering from the States (figure a 75% price increase when we finally get our stock)

So price is an issue. The fixings for a dozen arrows will cost about \$30- \$50 depending on what kinds of volume you order in. We in Dragon Dormant are lucky because we have a Canadian distributor, [Tele Transactions Traditional Supplies](#) that gets the big volume discounts and so passes them along to us when we order as a company, If you are in Canada I highly suggest you give Gabriel a call.

If you are in the States I can recommend by experience [Diana's shaft shop](#) in Sterling CT. or [3Rivers archery](#) in the Midwest. There are many other distributors in the US but I haven't tried them so can't recommend them.

What kind of bow do you use?

Longbow or recurve, flatbow or some fiberglass Wal*mart special, do you shoot off your knuckle or is the bow center shot? It really doesn't matter right now what you use so long as it is your regular bow. This is important because your bow will dictate the draw weight and mass weight for your arrows. as well, it dictates the leeway within which you can allow variations from the best case arrow.

If you use a different bow every time you shoot, you cannot hope to have a set of arrows to match the bow unless you make a dozen for each bow (very expensive). So choose one and stick with it.

Ok now do you have one particular bow in mind? Good, now what is the draw weight? You will need this later so write it down, on the bow if you can do it without damaging it, is best. You want the bow and arrow to match as closely as possible most of the time but there are times when you will want to deviate from this.

Each bow, as I mentioned before, has it's own preferred spine range. Longbows have much less leeway than recurves in what spine weight they can use safely and generally require a somewhat lower spine to allow for the arrow bending around the bow. A recurve can safely shoot arrows with a broader range of spine weights but will prefer something a little heavier than the draw weight of the bow, Bending less under the force and thereby making the arrow more responsive to the initial push of the bowstring.

I could get into force vector diagrams and fancy explanations of why this works the way it does but not here. If you want to know, email me and I would be glad to explain it to you.

Now that we have got that done we need to consider the arrows themselves and so, on to

What about your arrows?

As you read these many pages, we will discuss the various components and whatnot that go in to making your arrows, but before that, I wanted to finish this off with a bit of advice.

I would first pose you a question, What do you plan on doing with the arrows? Target shooting, stumpshooting, hunting? Well I suggest that you decide now because what I can teach you will work for any of these good and fun activities, however the main goal here is to help you make a reasonably well made set of SCA legal target arrows. I warn you now, that if you try to make your arrows do multiple

things, they will do none of them as well as they could if you specifically designed them for one task only.

Hunting arrows need to be heavier than target arrows to maximize penetration into your quarry. Extreme durability and longer range abilities really do not matter so much. Most of the time we wouldn't shoot at our quarry beyond 20 yards or so. At this range a flat shooting arrow isn't really needed and if it does it's job, it is not so important if it gets broken afterwards.

Stump shooting or roving needs the short range power of a hunting arrow and the durability to allow it to be used over. If the stump you thought you were shooting at turns out to be a rock, your fine cedar shaft will be ruined where an ash shaft will bounce off and be ready to go again.

For target shooting in the SCA, we need different qualities in our arrows. They must be fast and flat shooting because we shoot out to 40 yards with some hope of accuracy and we do not want to have to lob the arrow into the air to get there. The less time an arrow is in flight, the less time it has to be affected by air resistance, the wind and gravity. We do not need punching power and though durability and reusability is an issue at the target, the primary concern here is being struck by another's arrow while sitting in the target and as it is fairly rare, when it does happen, nothing you can do will make a difference.

I realize I have thrown a lot at you right off but I believe that this is what is needed to start you making a decent quiver of arrows. From here on in, the decisions you made will affect your shooting. In the next pages we will look at the components briefly and then get to actually putting them together.

[Next Page](#)

[Back To The DIY Page](#)

© 1999 Renny-James Bachner. All rights reserved. [suggestions and submissions](#)

Arrow woods

Written by RJ Bachner

- [The Decisions.](#)
- [The Shafts.](#)
- [The Feathers.](#)
- [The Nocks and Points.](#)
- [The Finish and Assembly.](#)

Part 2: The Shafts.



Ok, arrow shafts can be made out of many different materials, wood, aluminum, various carbon fiber wraps, lots of things. Only wood is considered SCA legal and so we will limit this discussion to Wood.

Wood is a natural material and as such is not completely consistent in the way it is made. No two shafts are exactly alike and so consistency is measured in spine and weight ranges. Wood is measured in spine ranges such as 45-50 lbs. This means that all the shafts in that range will spine out to within 45 and 50 lbs spine weight. This is as close as most suppliers will go when selling arrow shafts. You can pay a lot more to get them spined closer than a 5 lb range but generally you will not notice the difference.

Then there is weight; since wood density varies a lot with so many different factors involved, getting arrows that all weigh the same is even more difficult than getting them spined the same. The standard weight range is +/- 10 grains, again more than this is usually unnecessary as you won't see it in your shooting unless you are really good.

Make sure and I do mean make sure that you never buy shafts that are not grouped by weight as well as by spine. I have seen a dozen arrows of the same spine range vary their mass weight by more than 50% through a single dozen.

A number of years ago there was very little choice in shaft materials for constructing wood arrows, Port Orford Cedar (POC) was king. It was a good choice for consistent, straight arrows and, of course, the best part of the arrow was the aroma. You didn't seem to mind as much when you broke one because you got the added benefit of enjoying the aromatic cedar.

These days, Port Orford is still around, but in addition there are numerous other woods that are successfully being used to construct good quality arrow shafting. The old saying that necessity is the mother of invention applies here.

In the last 5 years there has been a marked decrease in the availability of quality Port Orford cedar shafts. Some may argue that that has not been the case, but even the perception of a shortage has sent inventive people out looking at different shaft options. Just look at any traditional archery magazine, ads for folks selling alternatives to POC are everywhere. Just a few are Ash, Chundoo (Sitka Spruce), Norway pine, Ramin, Birch, Maple, Yellow Cedar and the list continues. Each has it's advantages and disadvantages as we shall see.

Each material has its own advantages and disadvantages. Shaft sizes can now be obtained in **5/16"**, **11/32"** and **23/64"**. I will try to concentrate on some of the more popular shaft materials and discuss some of the characteristics.

Port Orford Cedar - These shafts are probably the standard by which all others are measured. There used to be two major manufacturers of Port Orford Cedar, [Rose City](#) and Acme. Acme hasn't made these shafts for several years, presumably because of difficult getting quality raw material. Rose City is still making these shafts and supplying them to various suppliers.

Port Orford Cedar is best know for its wonderful aroma. The shafts are light to moderate in physical weight and are generally pretty straight grained. A number of shaft suppliers are offering Port Orford Cedars that are tapered for about 9" on the nock end from 11/32" to 5/16". These tapered shafts are said to clear the bow riser for better arrow flight. You can also get barreled shafts that are tapered at both the nock and point ends.

Port Orford Cedar - Summary

- **Light to moderate in weight**
- **Not very durable**
- **Fairly Straight Grained**
- **Takes a stain well**
- **Fairly easy to straighten**

Douglas Fir - Douglas Fir has a lot more grain than PO Cedar and the shafts are heavier. I myself have little experience with it though and can't really tell you much about it except that it is reputed to be difficult to get straight round shafts, that being said, if you do get the good stuff, it supposedly does make a nice arrow.

maybe someone will send me some so I can test them and see.

Douglas Fir -Summary

- **Heavy weight**
- **Moderately Durable**
- **Lots of grain, less straight**
- **Takes a stain well**
- **Hard to straighten**

Maple - Some of the American hardwoods are starting to show up as arrow shafting material. Maple shafts are very smooth and uniform and have a very pretty grain. They are not as heavy or as durable as the Ash but seem to make a nice compromise of weight and strength. I think they are going to become my favorite stumping shaft.

Try Maple. I could only find them listed at [Allegheny mountain woods](#).

Maple -Summary

- **Heavy weight**
- **Very Durable**
- **Straight**
- **Hard to stain**
- **Hard to straighten**

Ash - Ash is one of my favorite woods next to POC. I use it for my medieval period arrows and for hunting and stumpshooting and just for the snorts and giggles of it. It is next to indestructible though I have managed to break some. It is really heavy, only available in 23/64ths diameter shafts (that I can find) and did I mention it was heavy? I have some 50 lb spine shafts that hit 8-10 inches lower than poc off of the same bow at 20 yards. They are nice and consistent but ohh soo slow.

Ash -Summary

- **Heavy weight**
- **Very Durable**
- **Not very straight**
- **Hard to stain**
- **Hard to straighten**

Southeastern Alaska (yellow) Cedar - These shafts aren't yellow at all, they're white. I have made several sets of shire arrows from Yellow cedar and was very happy with the way they turned out. I have to say though that this stuff stinks something horrible when cutting or grinding it, for those of us accustomed to the Cedar buzz from POC, this stuff was a real let down.

Yellow Cedar -Summary

- **Moderate to Heavy weight**
- **Very Durable**
- **Straight**
- **Takes Stain well**
- **Relatively easy to straighten**

Chundoo - Again I don't know much about Chundoo (I've heard it called Sitka Spruce and I have it on the good authority of a Canadian distributor that it is actually Lodgepole pine so I do not know who to believe.) other than what I have read in some of the references I use. I understand that it is a little bit heavier than POC, but is straight and consistent and I am looking to get my hands on some to try.

Chundoo -Summary

- **Moderate to Heavy weight**
- **Moderate Durability**
- **Straight**
- **Takes Stain well**
- **Relatively easy to straighten**

Laminated Cedar or Pine - Shafts made from pieces of pine or cedar that have been laminated together to form a more homogeneous material are said to be made so that weight, spine and straightness can be controlled in the manufacturing process. I would be interested to know what people who have used these shafts think about their quality.

Laminated Cedar or Pine - Summary

- **Heavy weight**
- **Very Durable**
- **Straight**
- **Takes Stain well**
- **Difficult to straighten**

[Next Page](#)

[Back To The DIY Page](#)

© 1999 Renny-James Bachner. All rights reserved. [suggestions and submissions](#)

Feather Fletching

Written by RJ Bachner

- [The Decisions.](#)
- [The Shafts.](#)
- [The Feathers.](#)
- [The Nocks and Points.](#)
- [The Finish and Assembly.](#)

Part 3: The Feathers.

Ok so now we have covered shafting, you need to consider the fletching: Feathers by another name. There are types and sizes and shapes and what wing to use and all this will become as second nature to you later on but for now trust me.

First you must have actual feathers on SCA legal arrows. Plastic vanes are not only ugly but they are not period, no matter how much duct tape you use.

Real period feathers were duck or goose or peacock if you believe Chaucer but today most commercial feathers are made by either Gateway or Trueflight near as I can figure and they both use commercially farmed turkey wing pinion feathers.

'...he was clad in cote and hood of grene; A sheef of pecok-arwes bright and kene Under his belt he bar ful thriftily: His arwes drouped nought with fetheres lowe), And in his hand he bar a mighty bowe. A not-heed hadde he, with a broun visage. Of wode-craft wel coude he al the usage. Upon his arm he bar a gay bracer, And by his syde a swerd and bokeler, And on that other syde a gay daggere, Harneised wel, and shap as point to spere; A Cristofre on his brest of silver shere. An horn be bar, the bawdrik wqs of grene; A forster was he, soothly, as I gesse.'

Chaucer.

Now when buying your feathers, you are going to be presented with the choice, Right wing or Left wing. Which do you prefer? Some will tell you righties should use right wing (RW) and southpaws should use left wing (LW).

The wing choice will affect primarily in which direction the arrow will spin once released from the bow but since high speed photographic evidence has proven that the arrow doesn't start to spin noticeably until after it has cleared the bow, old arguments are moot and to be honest it doesn't matter one bit which wing you use as long as you are consistent on the arrow.

Do not mix wings on any one arrow. For that matter do not mix wings on any matched set of arrows.

Actually being able to tell the difference between one wing and the other is a useful skill to have about now and to be honest it is hard for me to remember which is which so I printed this picture and put it over my workbench.

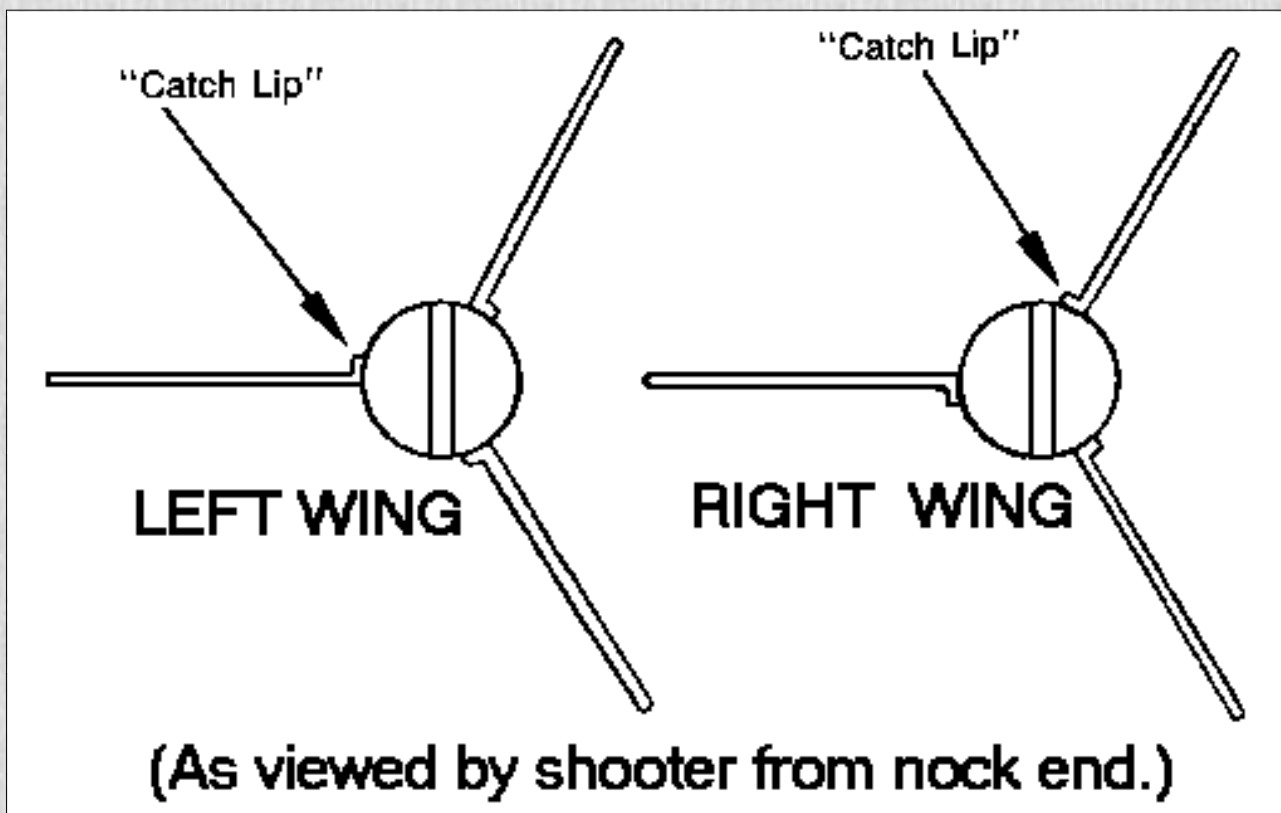

Now we need to choose which shape and size you want on your arrow and since shape is the easy one, we will do it first.

The shape of things to come

There are many shapes of fletching but they all are based on 3 simple ideas:

- Primitive - The simplest of shapes, you take a feather and cut a 3-6 inch length and glue it in place.
- Shield
- Parabolic



Which you choose is up to you, me I like the parabolic as do most of my compatriots in our archery company which you visited first to get here.

The size of the fletching is also important, a bigger feather will catch more air and stabilize the arrow faster but with more air resistance and therefore less velocity down range. This is good if you have a big heavy arrow with a bladed broadhead and your ranges are short.

However, for our concerns, this is not, or at least should not be the case. We shoot no broadheads at SCA

targets and since we desire the fastest arrow we can manage, we should look to smaller feathers as another way to maximize our arrow speed.

The drawback to this approach is that there is less feather to stabilise your in-flight arrow and so it is less forgiving of mistakes.

I myself have been using 5 inch Parabolics for convenience but I have come to realize that that is too much feather and I am moving to a smaller size by way of experimentation.

[Next Page](#)

[Back To The DIY Page](#)

© 1999 Renny-James Bachner. All rights reserved. [suggestions and submissions](#)

Nocks and Points

Written by RJ Bachner

- [The Decisions.](#)
- [The Shafts.](#)
- [The Feathers.](#)
- [The Nocks and Points.](#)
- [The Finish and Assembly.](#)

Part 4: The Bits At Both Ends.

Such a simple thing, putting the nocks and points on a shaft, one might think it hardly worth more than a moments notice. I warn you though, do it wrong and you will curse the day you felt so lazy.

Taper Taper

On normal wood arrows, the points and nocks are glued on to the shaft by first tapering the shaft with a proper tapering tool and then aligning them correctly so that they are straight and all on the same way. To do this correctly you must first taper the shafts correctly, making sure the angle and alignment of the taper are perfect. For if they are not, the nocks and points cannot be mounted properly and the arrow flight will be poor and erratic.

There are a few good tools out there, varying in price from under \$10 to over \$100, which one you want depends on how many arrows you plan on making and the relative quality you desire of your shafts. For the time being I use a midlevel model for about \$25, it is reversible, so it can cut both 5 degree and 11 degree tapers. It comes with screw on guides for all 3 standard shaft sizes and the blades are replaceable. Eventually I will move on to an electric grinder designed to do the job faster and more accurately as well as more expensively.

Now when cutting the tapers, you must make sure the guide fits exactly to the shaft and is as close to parallel to the long axis of the shaft as possible; this will make sure that the taper is a consistent radial reduction along the axis of the taper. I am sorry, there is no simpler way to say this but until I can make a proper drawing it will have to do.

One way to tell the two tapers apart is that the nock is a short steeper taper at 11 degrees and the point is a longer, less severe taper at 5 degrees.

Nocks and more decisions

Before you have mounted your nocks, you will have decided what sort of nocks to use. **This is important so don't roll your eyes at me.** Do you want a snap nock which will hold on to the string ever so slightly or do you want a speed nock which will not hold the string at all? I recommend a snap nock for a beginner and as well for more experienced archers. There are few things more annoying that

having your arrow fall off the bow as you draw it, it slows you down and gives everybody a chance to snicker at you while on the line. No matter what you choose I also suggest you get a model with an indicator tab so that you can tell by feel which fletch is the cock and do not have to look. (this of course assumes that you lined up the indicator and the cock when you fletched the arrow)

When gluing the nock on, first determine which way the grain runs. I like to mount my nocks perpendicular to the grain so that I lessen the chances of splitting the arrow if I split a nock on the string. Also, if you can imagine how a 2x4 maintains it's stiffness in one orientation but bends relatively easily if you turn it 90 degrees. Well the same thing happens to an arrow, it is stiffer when you bend it with the grain than across it. I have found that this is the most efficient way to mount my nocks, the arrows fly nicely and many other so called experts agree with me or I with them, however that works.

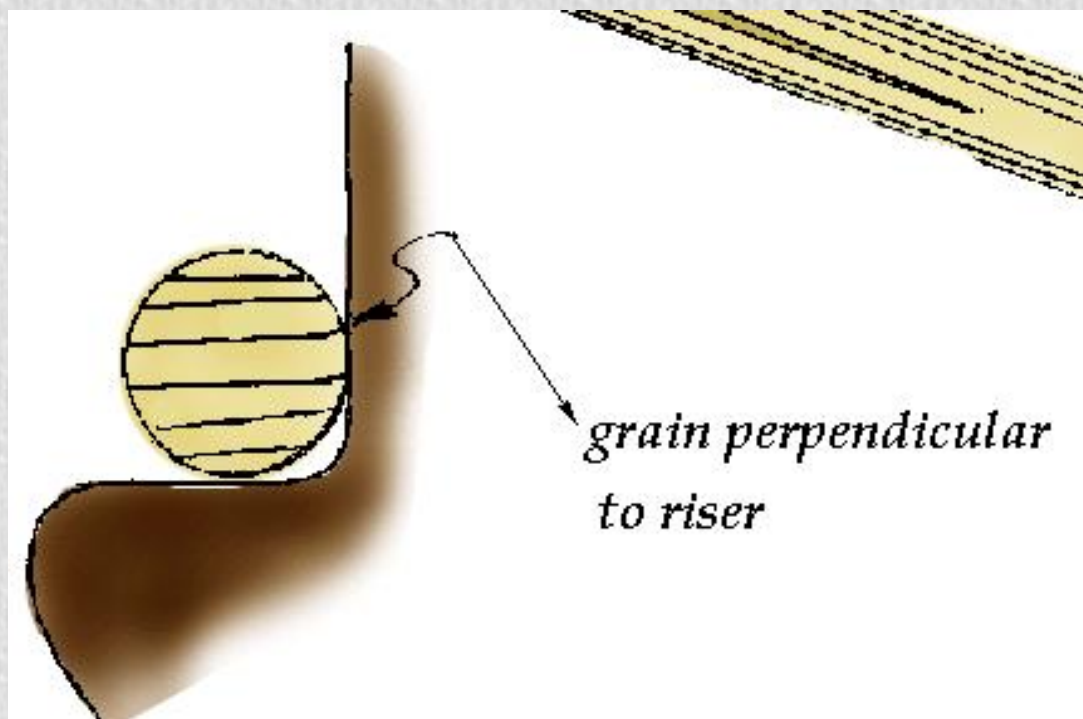

Just so long as you always glue them on the same way to maintain consistency across the set, which way probably matters little.

Note: I like to use a cyano-acrylate glue to mount the nocks and feathers and heat melt for points, so do yourself a favor and taper only the nock end before you dip the shafts. This will allow a prettier assembly of nock to shaft and the C-A will bond nocks to the sealer. Then you can taper the head once the shaft is finished so that you have a clean wood surface to bond the point to.

Lately I have been playing with using Weldbond® glue to mount my points and nocks and it seems to work quite nicely. I do not know what the long term will show but if it works well I think I may use it rather than the c.a. and heatmelt glue, it seems so much easier to me.

Pointing the way

In SCA archery, we only use field points or bullet points, no broad heads, bodkin points or other cool things some folks can think up. Trust me, I tried. I have been the cause of more than one hold called on the line while I was informed that some ghastly flamberged 4 inch bladed head was not allowed on this range and no argument about wanting to be a member of the horde and therefore it could be period would be allowed. Oh well, so much for my pumpkin splitters. Anyway, simple points only is the rule

and my personal feelings aside, that is what we will do.

This is possibly the only dangerous part about making arrows, we will use heat melt glue to mount steel to wood so the point will be real hot while we are working with them. For that matter, any glue that oozes out will be not only hot but sticky so if it gets on you it hurts and won't get off. Make sure that you can comfortably work with an open flame and hot stuff before you get started here, if you are a minor, making sure your parentals are with you would not be a bad idea.

We will need:

- A candle or propane torch.
- Good heat melt glue.
- Points and tapered shafts.
- Good heat insulated pliers.
- Some 0000 Steel wool.
- A scrap of wood or thick leather.
- A bowl of very cold water. A wide stable bowl is best.

Preparing the points.

The points are made of steel, at least they should be, anyway when they are manufactured they are coated with a thin oil to prevent rust. Oil and glue do not mix well so you will have to clean the points so that the glue will bond them to the shaft. I like putting the points in a big bowl and mix in a liberal amount of some grease cutting dish soap and boiling water. Stir the mess up and then let it sit for a while and let the oil dissolve. After about an hour or so, rinse the points in more boiling water until you are sure there is no soap or oil left on the points. pour the points into a colander and drain well. They should be as hot as the water was so if you get most of the water off them they should dry of their own accord fairly fast.

Now find yourself a thin rod that will fit inside the point and wrap some fine steel wool around the head like a q-tip then scour inside the point well to roughen the surface. This should make sure that those "ratsfratin" points don't come off in the target too often.

Take the shafts in hand and melt a small amount of glue on to the narrow part of the taper, you would be amazed at just how little is actually used. To get the right amount takes a little practice, I find a thin layer, 1/4 inch wide around the taper tip is more than enough and infact probably too much. Repeat this step for each of the shafts and put them aside for the moment.

Once all the shafts have been glued up, take one and press a point on it as far as it will go with your fingers. This allows you to heat up the point insitue without the risk of burning the end of the shaft and discoloring it or having to handle a hot point. Heat the point over the flame until the point moves about on it's own, you should see some of the glue bubbling out of the point. At this point press the head onto the scrap of wood or leather as hard as you may while spinning it, you want to force the point on as far as you can and squeeze out the extra glue while it is still hot. when it seems that you can press it on no farther and the glue is cooling, put the head into the cold water to flash harden the glue and keep it there till the head is cold.

Wipe the water away from the point and spin it carefully to see if the head is on straight, if it is, fine. Trim off the extra glue and move on to the next. If it isn't straight, you have to reheat the point and do it again till you get it right. Don't heat the point so hot this time though, it really isn't needed, just hot

enough to move the head and align it properly. Cool and inspect it, repeating until perfect then move on to the next one.

[Next Page](#)

[Back To The DIY Page](#)

© 1999 Renny-James Bachner. All rights reserved. [suggestions and submissions](#)

Finishing and assembly

Written by RJ Bachner

- [The Decisions.](#)
- [The Shafts.](#)
- [The Feathers.](#)
- [The Nocks and Points.](#)
- [The Finish and Assembly.](#)

Part 5: Finishing the shafts.

Ok, now it is time to put all this together into a set of arrows you can be proud of and again I will present you with a list of things you will need.

- Assemble all of the assorted pieces before you.
- A fletching jig to mount the feathers.
- A dip tube to seal the shafts and a rubber squeegee top to scrape off the extra sealer.
- The Sealer of your choice, such as Flecto brand polyurethane.
- A ruler to measure your shafts.
- A very fine toothed (+/- 40 teeth to the inch) cutoff saw.
- Heat melt glue for the heads and Cyanoacrylic glue (CA) for the feathers and nocks.
- Some tool for straightening the shafts such as a hook or a roller.
- Some very fine 0000 steel wool and a 3 inch square of hard flat leather.
- If you wish to crest the arrows, some paint, a fine brush and some method to turn the shafts.

Wash your hands well. No oil should get on the shaft and wash them often if you have to.

Start with fresh clean shafts, give them a final inspection for imperfections, straighten any that are not right and decide which end will be the nock end for each shaft. Give each one a quick wipe with the steel wool to clean off any dirt and splinters.

Carefully cut the nock taper as I described earlier, do not bother with the other end for now. Make sure that the taper is neat and clean with no torn wood. If the taper tool is tearing the wood, get a new blade for it. Clean each cut with the steel wool.

We are now going to dip the shafts in a sealer. I will describe the way I do it, some folks do it differently and nobody is any more right than any one else. I use a Little dipper from [3Rivers](#) to do the crown only, I finish the rest of the shaft with a rubbed oil finish. Some folks will dip the whole shaft, I do not but you can if you wish. I also use a mason jar lid on the dipper and instead of a hard lid, I replace it with a rubber squeegee with arrow size holes in it. This allows you to wipe off the extra polyurethane and it dries almost instantly.

I have mentioned my choice of dip, Satin finish polyurethane. I like it cause it works well and is cheap but do not use the full gloss version, no glue will want to reliably stick to it. If you can get it, undiluted auto lacquer also works very well but it really isn't available in Canada anymore. You can also use the Bohning brand stuff from [3Rivers](#) but it is much more expensive and I never saw an advantage to it. To a certain extent, what sealer you chose will dictate what glue you use, fletch tite works with the Bohning brands perfectly. Duco cement works with Polyurethane quite well but I find it a bit slow to cure.

Recently I stumbled upon another solution and I think it is best. Super Jet brand cyano-acrylate, medium viscosity for wood modeling such as airplanes and boats. it is fast but not instant like crazy glue which is a little safer for those of us who tend to be clumsy. It takes about 25 seconds to bond, is thick enough that it doesn't run too much and works very well with Polyurethane. I can fletch a dozen arrows with a single jig as fast as anybody can with a six jig and fletch tight.

The dipping

Take a shaft and put it in the dipper, nock first, and slide it all the way in. Let it sit for about 10 seconds so that the shaft can absorb the Polyu then draw it out and repeat it a couple 3 times, this allows a thin coat to build up on the shaft. Remove it from the dipper and carefully wipe off any extra with a dry lint free cloth with a fast wipe towards the nock and set it aside to dry. Repeat with the next until all have been done once.

Let them sit for about an hour, when completely dry move away from your dipping area and give them a good polishing with the steel wool. This will start to give them a nice sheen. Once this is finished, wipe them with a dry cloth to remove any dust and redip them as before then dry, sand, redip again, sand and you should get a nice smooth glossy surface that is 3 to 4 coats thick. Depending on the wood, sometimes more than this is needed but for POC, 4 is as much as you will want as it adds weight.

Note: A thing to remember here is if you are going to do it this way with just the crown dip. you want a clean neat border between the wood and the end of the dip. any build up here is messy looking and hard to get off once dry. Try to make sure it stays even and smooth and it will look fabulous when finished.

When you have finished the dip and are satisfied with the results, you will have to finish the rest of the shaft with an oil like boiled linseed oil or lemon oil or my favorite, tung oil. The oil will soak into the shaft and keep it from being affected by moisture but must be repeated periodically. Follow the procedure as with the dip but instead, soak a sponge in oil and lather it on as thick as you can, scrubbing it in like you would a hand rubbed piece of furniture. Let it dry, sand it then burnish it with the hard scrap of leather and repeat as many times as you feel it needs. This will provide a nice deep gloss that looks real pretty and the separation between oil and polyu is quite nice and rather distinctive. Spraying the wood with a little furniture polish once and a while will keep it nice and helps you draw the shafts from your target.

The nocks

We have already discussed the attachment of the nocks and now is the time to put it into practice. All you need is a tiny amount of the CA. What I do is hold the shaft nock side down and put a tiny bit of glue around the tip of the taper. Since you have about 20 seconds I put the nock on the shaft, twisting it and trying to get it on straight, check it once and correcting it quickly, making sure that it is lined up perpendicular to the grain. Repeat for the whole set.

The Fletching

This is one of the most critical steps to making arrows, gluing the feathers on. If they are not straight, the arrow will not fly right, simple as that. That being said, you have a choice of how to mount your feathers. Straight or helical. I recommend straight fletch for some simple reasons.

It is

- Easier to glue straight fletching on,
- Cheaper to only have to have 1 type of jig as RW and LW helical need separate jigs and
- The arrow goes faster without the extra drag and since even straight feathers impart enough twist to stabilize the arrow, helical is really not needed.

When gluing the fletch you must decide how far along the arrow you want the feather. I like to have them start about 3/4 inch ahead of the nock with parabolic fletching, so before gluing the feather, put a feather into the clamp, put a shaft in the jig and fiddle with the set up to make sure your fingers will clear the fletch when you draw the arrow. Another consideration is feather offset or how much off the centerline of the shaft do you want the fletching.

I like to be just enough off center that the whole catchlip sits flush on the shaft because otherwise the amount of contact surface is reduced by as much as half which reduces the strength of the bond between shaft and feather and makes the glue job look a lot messier.

I know this is hard to understand but if you refer to the diagram below you will see how the catchlip extends out from the feather and can work to make the base of the fletch much more secure if considered properly.

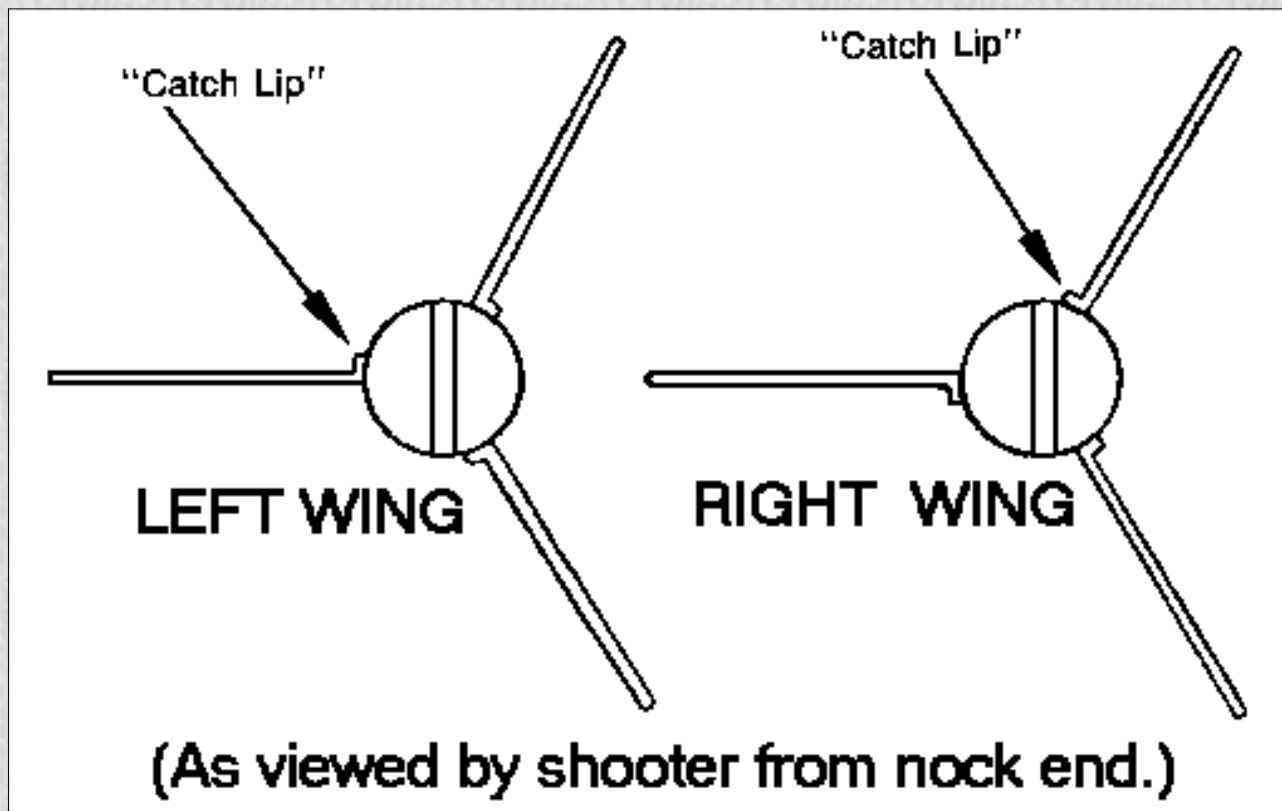

Are you satisfied with your setup? Then lock everything down and mark on the clamp where you want the feather to fit so each successive feather will be in the same place.

Now I always start with the cock feather but this is just my own ritual. I align the jig so that the cock feather is the one to be mounted and I run a thin, even layer of glue down the feather base, making sure that you do not slop it all over. It is not hard to do but so many folks make such a bollixed job of this that I have to wonder why I don't. Make sure you don't mess up the clamp with glue either, this just complicates your life.

Note: The cock feather is the one that is at right angles to the nock, so that when strung on the bow it faces away from the side of the bow. on the diagram it is the feather that points to the left.

Now remember you will have about 20 seconds before the glue bonds so there is no need to rush, carefully put the clamp into the jig and use finger pressure to clamp the feather down on the shaft as hard as you may to make sure that the bond is even for about 20seconds or until the feather won't lift off the shaft.

There. You have just glued a feather to the shaft, feel good? you should. You have taken the first steps to understanding something of your heritage as a Human, the bow is thousands of years old yet the discovery that led to fletching may have been one of the most important ones ever made. I do hope you too can appreciate the sense of history you hold in your hands as you repeat the fletching for each arrow.

All we have to do now is measure the shaft for length, cut it to length and mount the heads. What length you ask? Well it is your draw length plus a little bit and you can measure the draw by placing the nock into the hollow spot at the base of your throat and holding the arrow by the finger tips, stretch your arms out in front of you as far as you can with the finger tips pressed together. This will be your draw length then add about 2 inches and you have your arrow length. Cut the shafts off there for each shaft and then taper as we discussed previously and mount the heads. When this is done you will be finished building your arrows, inspect them, straighten them if they need it and go shoot.

[Back to the Start.](#)

[Back To The DIY Page](#)

© 1999 Renny-James Bachner. All rights reserved. [suggestions and submissions](#)

How to straighten your wood arrows.

Written by RJ Bachner

One issue that plagues most traditional archers and Medieval ones as well is crooked shafts. After all, we make our arrows out of wood and wood bends fast and furiously under certain conditions so we must adopt some skills and strategies to combat this pain in the patootie.

There are a few factors involved in keeping your arrowshafts straight, such as moisture content, elastic memory in the wood, training, storage, gravity and most importantly, the consistency of handling.

Moisture content

Firstly I think I will discuss the effects of moisture on wood, as far as it concerns us anyways. Wood loves moisture, it will soak it up as fast as it can till saturation then it rots. This is nature's way of recycling woodfiber, not what you want to have happen to your hard earned arrow shafts. To prevent moisture from soaking into the shafts we seal them with varnish, polyurethane, oils, waxes, something, everybody has their favs. This seals the shaft and holds what moisture and oils exist in the shaft where they belong while keeping the balance from changing as external conditions change.

Someone asked me why we should care about moisture content and the answer is both simple and complicated. Totally dry wood is brittle and splits easily when the moisture content is at 0% which is a bad thing considering the stresses we place our arrows under. As well, too much moisture can weight a shaft down and cause the individual wood fiber cells to swell which changes the internal stresses and causing the shaft to bend into new and weird shapes as these stresses try to work themselves out.

Imagine a handful of tiny balloons, each filled with water to a 1 inch diameter. Now we know water does not compress so as this jumble of balloons tries to settle itself in your hands, each balloon will change shape slightly to accommodate it's neighbors. If you could by some means now increase the volume of each balloon, you would see them all change and grow. This would not just change the shape of the balloons but of the whole jumble and so it is with wood fibre.

Elastic memory in wood fibre

Since wood is a natural material subject to a myriad of natural stresses during growth that we have no control over, wood shafts are naturally a wildly varying lot. Each shaft is slightly different as the wood grain runs through it differently and subjects it to internal bending stresses due to less than even moisture content in the wood. All is not lost though so bear with me.

Every material has a certain amount of give to it, where, when a force is applied to it, it will bend out of the way then snap back when the force is removed. This is called "elastic memory" and is what keeps the shaft in whatever shape it holds. There is a limit to this elastisism though, it is called the "elastic limit", beyond which the material will have taken a new shape and will not

spring back to it's old shape. This is also called "plastic deformation" and is a property we use to force a shaft back to straight.

Training

Arrow shafts are not straight by nature, they are wild, untamed and will go all willy-nilly as conditions allow. However you can train them to be straight by straightening them properly and keeping them that way. After a while the shaft will accept the new condition, that of being naturally straight and they will want to stay that way. If you comb your hair the same way all the time, it eventually will want to naturally fall that way.

There is a technique to training your shafts that I have learned over the years and it is as follows:

- Store unsealed shafts in a place where the moisture level does not vary much but is about an average for your area. For example Montreal, where I live, is a very humid place so I let my shafts equalize with the environment in a closet where the moisture level changes little over time.
- keep these shafts in firm bundles with elastic bands so that they all may support each other and all take the same shape. The bundles should be stored flat on a shelf or in a box so that the whole length is supported and not allowed to sag.
- when ready to work with the shafts, straighten each one then dip them in your favorite sealant with 2 or 3 light coats. Do not allow the shafts to soak up huge amounts of the sealant. When dry, straighten them again and re bundle them so that they may once again come to balance with their new condition as the sealant fully dries into the wood.
- From that point on, as you work on them, each step should be followed by straightening until the naturally want to stay that way
- Once completed they should stay straight but just before using them you will want to make sure each and every time. Something in the way they were carried or laid down or maybe they were squished during the ride to the shoot, anything can put a new bend in them so make sure, take care and they will hold straight.

Straightening the shafts

Up till now I have given you some of the theory behind straightening a shaft because I do not believe that you can really do a good job if you do not understand what is happening. I do hope I have not bored you too badly :) but now we get to the meat of this page. Just how do we get these ratsafrafit kinks out of my expensive arrows shafts, you ask? Well it involves applying pressure to the bend in such a way as the bend is reversed, along the length of the bend with sufficient force to alter the woods shape (Plastic deformation).

First off we need to identify the location of a bend and to do that we have a most excellent tool. Our eyes. What I teach is to hold the arrow up to some light or well illuminated surface and while holding one end close to your eye, turn it as you look along the entire length. Unless the bend is very subtle, it should be plainly obvious to the naked eye and you will be amazed at just how little of a bend will show up under such scrutiny.

Now, you want to support the shaft on both sides of the bend if you can with the bend facing away from you. Using light pressure from whatever tool you choose to use, try to bend the shaft back towards you, reversing the kink. To do this you will rub the tool up and down the shaft from one

end of the kink to the other. As you rub the shaft it will bend at that point, compressing some of the fibres and stretching others, ironing out the kink by deforming the wood and introducing a new state to those fibres. Do not press too hard or the shaft may snap but you do not want to go too light either. A little practice will show what works best.

When supporting the shaft, I usually put the point on something solid and hold the shaft just above the section that kinks so that when I apply the tool, the whole shaft is not bent but just the kink. If you only hold the shaft at the ends, when you force it, you lose efficiency as the whole shaft bends and you have to use more force. You can also mung up other areas of the shaft and then you have more work to do or even over stress the shaft and snap it. (Been there done that)

The tool I use is, of course the cheapest solution that I can find and I am very satisfied with its performance. It cost me 69 cents and I can carry it with me everywhere while shooting. It is a 6 inch threaded hook bolt, the hook is nicely rounded and I have polished it a bit with a very fine 3/4 inch round file. This allows a good grip on it because it is long enough to fit my big hands and the round hook does not press any flats into the wood when being used. The wood compressed is rounded and does not mar the finish of the wood.



Some folks insist on using such things as shaft tamers® or brass hooks sold specifically for the job but they do not work better than the hook and cost way more. I have also seen people use their hands and the field point of another arrow but it is hard to gauge where you are pressing with your hand and if you have many to do this can be hard on your hands. As well I have broken arrows trying to use a field point so I prefer my simple tool.

[Back To The DIY Page](#)

© 1999 Renny-James Bachner. All rights reserved. [suggestions and submissions](#)

Matching your arrows

By RJ Bachner

Have you ever considered making your own arrows? Having considered that, you probably looked into how to do it and came across such arcane terms as front of center (foc) or Matched shafts? Well we are here today to explain such as this to you. Believe it or not your ability to get better as an archer depends on such arcanery as this.

Note:

This is for people that know next to nothing about fletchery, you will read some things that are not technically correct but explain better the way I have written it. If you can tell what is being fudged then you do not really need this little primer but for the rest this will provide you with enough basic knowledge to get the job done and will allow you understand a complicated issue in small steps.

We who use wooden arrows are faced with a number of technical handicaps, wood is not consistent and therefore each and every shaft is different. Weight varies, spine varies, this you can do little to fix but strive to combine arrows that all rest with in certain set standards for accuracy. By minimizing variance in these and other factors such as foc and having properly matched arrows we can minimize the mechanical side of our handicaps and move on to the mental and physical ones that impede our dream of being a ludicrous Bowman.

I suppose I should start out by defining "foc" and "Matched set" hunh?

- **Front of center (foc)** is a value that represents the ratio of the difference between the balance point and the center point of the arrow divided by half the length of the arrow. I know it sounds complicated but it isn't.

Basically as you release the arrow, the force of the bow is transmitted into the arrow as forward motion or Kinetic energy which changes to potential energy when arrow and string come apart. This "energy" for the lack of a more descriptive word, is assumed (for the sake of theoretical physicists) to be contained in the front end of the arrow and infact the arrow is sort of pulled along behind the point.

Of course this is assuming that the balance point is infact in front of the center point of the arrow by about 10-15 % for heavy or hunting arrows and closer to 10% for light weight arrows . More than this and the arrow is nose heavy and becomes unstable quickly as the fletching cannot stabilize the flight and any breeze will throw the tail about. Less than this and the arrow becomes tail heavy and as it slows down will start to stall and destabilize just like a plane will if it slides backwards.

You may hear some folks talk about the foc being at the $2/5^{\text{th}}$. They mean that the foc should be $2/5^{\text{th}}$ of the total length behind the point. This works out to about 10% so either way they are right and you have nothing to worry about.

To Calculate foc you simply follow some simple steps.

- 1. measure the arrow from the point where the shaft meets the nock and the point where the shaft

meets the point.



- 2. Calculate the center point.



- 3. Balance the arrow on a sharp sturdy surface so that the balance point can be measured accurately. Write this down so that you can use it later.



- 4. Calculate the ratio of foc by subtracting the center point from the balance point, this is called the difference. Now divide this value by the centerpoint and multiply by 100.



$$\text{RATIO} = \left[\frac{\text{DIFFERENCE}}{\text{LENGTH}} \right] \times 100$$

- **Matched Sets.** of arrows are ones that have been measured and tested to within certain standards so that they may all be as similar as is possible.

As I said before, wood is variable and not consistent, this forces us to adopt standards of precision that are, well they are "close enough". Most fletching suppliers will provide arrow shafts in 5 lb spine groups, where all the arrows will be spined at between say 45-50 lbs. For most newbies, this is a sufficiently precise group that beginners will not see much of a difference if we spined them any closer.

The reason the suppliers do that is so that they can get more use of their stock, if they had to separate them into +/- 1 lb or half a pound or whatever then there would be 13- 49 lb arrows and 7- 46's and 23- 44's and so on. you can see the problem with that from a suppliers side can't you?

However for a skilled archer that will not be enough, as spine weight varies, the location of the arrow on the target will vary left and right. For my own arrows I spine them to within +/- 1/2 lb. My 47 lb arrows all sit within 46 1/2 and 47 1/2 for accuracy.

The other thing is to match them for weight, +/- 10 grains from the supplier is normal. This gives a 20 grain range. Trying to go for closer weight is possible and maybe even worth it as you get better but again for most newbies it won't make much difference.

If you want to get it to a more exact measure, there are 2 steps to getting there. Firstly you need your otherwise untouched shafts, tapered as cleanly as possible, a good grain scale and a sharp taper tool.

- You must first weigh them all and choose the lightest one. This is the one you will bring all the others down to.
- Now using the taper tool, carefully remove wood from the nock end of each of the heavier shafts until it matches the lightest one.
- **Note:** This will work best if all the shafts are closely matched to begin with or you can shorten some shafts so much you will significantly alter the foc and throw the whole thing off again.

Once your raw shafts have been brought down to the same low weight mark, you need to:

- Stain, paint and crest them, this all adds weight so do try to be consistent in this.
- Then you must dip them in sealer which adds a lot of weight, about 5 grains a coat.
- When they have had 3 coats or however many you feel they need and have dried completely weight them all again.
- This time select the heaviest one and bring them all up to it's weight range. You do this by giving lighter arrows another dip or 2 in the sealer at 5 grains a dip to bring the weight up. (1 dip at a time with a drying period in between)
- Now you assemble the complete arrow being carefull to avoid adding too much weight with glues and whatnots.

Ok, now that you have your shafts all measured and you are happy in how they match, you need to test them to make sure they all fly the same. This is the pesky bit I hate to tell people who cheaped out and only bought a dozen shafts. You have to make up a bunch of arrows and shoot them to see where they each go.

I seldom make arrows in groups of less than 24 and I do not recommend you do less if you would be accounted a good archer.

- First you must number them all, sequentially works well and take notes on how each one flies to the target. Choose a nice still day, mornings are best I find. When you have shot each one 10 or 15 times, shooting the bunch sequentially as you numbered them, your notes should show which ones consistently go high, low, dead on or wild.

Shooting them in this way will allow you to eliminate your errors of form by increasing the sample size and giving you a better averaged idea of what that arrow will do. You do have to record the position for each arrow and I would also suggest you have someone else do this for you.

Have them hand you each arrow in order and then record high, low, dead on or wild for each shot, the actual score matters not.

- Group like with like, high with high, low with low and dead on with dead on. Hopefully you have enough arrows in this batch that you can make 3 bundles of at least 6 (an end in the sca). The wild ones, if they cannot be fixed should be tossed, or better yet donated to someone who doesn't care.
- **Wild arrows can be caused by many different things, the bow string may be fraying or have broken strands, the fistmaile may be off, the bow may be broken or breaking or just plain too heavy for you. Are your sleeves catching in the string? Various body parts? What I am trying to say is that a lot of wild shots may be indicative of your own shooting and not the arrows so don't assume that the arrows are at at fault right off.**

I recommend cresting them to show each group from another, kinda like transistor stripe code where each pattern means something specific.

At this point you should have a pretty good idea of where your arrows hit in relation to one another so now go see what you can do on the range.

[Back To The DIY Page](#)

© 1999 Renny-James Bachner. All rights reserved. [suggestions and submissions](#)

How to make a dip tank for cheap.

Written by RJ Bachner
Pictures by Jason Farrell

As I am sure most of my loyal readers know by now, I am painfully cheap when it comes spending money. I also hate being cheated and I am certain that the prices involved in purchasing fletching equipment is what my friend once called a "profit oyster".

Dip tanks are another example of this price gouge in action and so I decided that if I was gonna have to make arrows, I would need to make some dip tubes so that I can stain and seal them.

So I thought to myself, how can I make a dip tank that is simple, easy to use, elegant and cheap. I came up with a number of ideas using tubes, hoses, pipes etc then trotted off to the local renovation center to see how my theories stood up to the bright light of reality.

One thing to remember here is that there are lots of options in tubing around, from PVC to plain white plastic to copper and steel and aluminum. The PVC is best as it is cheapest and it will not react with most of the thinners out there but you should test to see first (white electrical tubing will melt right off the bat so forget it.). Copper will react with some of the thinners and it is way more expensive than PVC. Steel will not react but it weighs a ton and is also not cheap. Aluminum may work if you can find the right size tubing but again, \$\$\$\$\$\$\$\$\$.

Try number 1:

I First decided the the cheapest way I could do it was the best. It involves a 30 inch section of black garden hose with a plug in one end and a 1 inch to 2 inch hose adapter as the reservoir. It worked, well it did to a point. The hose would not straighten out on it's own and even if it did, it would not stand on it's own and would require a stand. So I duct taped it to an old level I had and voila. It is not what I had wanted but it works. It is not elegant or so easy to use but it is simple to make and cheap. In Canadian funds:

- 30 inches of Black PVC garden hose= \$3.60
- 1 end plug= \$.67
- 1- 1inch to 2 inch adapter=\$1.27
- Total: \$5.54



Try number 2

Ok that was the quick and dirty way to do it and there are a lot of less than optimum design concerns but it didn't take much to fill the hose, something like 23 cubic inches of liquid.

Now I am gonna show you my next option, I used hard PVC Pipe which made it self supporting but I could only find the 1.5 inch id pipe. Which annoyingly enough doubles the volume of the tube to more than a single pint can of whatever finish you chose to use, somewhere around 53 cubic inches.

I found a selection of caps and adapters that fit the PVC pipe so I could pick and choose the best options available. On the bottom I put a press fit cap (which you need to glue in place with abs cement) and on top I found an adapter that allows you to fit a screw top to the pipe which also functions as a reservoir but it is the same inner diameter as the PVC pipe so you have to be careful how high you fill this one. With the screw top you can store your finishes in the pipe without worry (Just make sure you mark what is in each tube) and it is easy to fit a rubber squeegee to the top with a minimum of fuss and muss.



It works wonderfully and fits most of my requirements nicely. It is simple to make, elegant to look at and use and is quite cheap. I can buy the PVC in 6 foot or 12 foot lengths at my local hardware store but you may find other options locally.

If I could, I would find and use 1 inch id PVC pipe with a 1 inch to 2 inch screw top adapter. but I was told that that is not a common item and hard to find, however this way works fine.

- 6 foot 1.5 inch id PVC pipe=\$3.82
- 2- 1.5 inch end caps=\$1.34
- 2- 1.5 inch screw cap adapters=\$3.42
- 2 1.5 inch screw caps=\$2.00
- total for 2 dip tanks=\$10.58=\$5.29 each.
- 1 small can of ABS contact cement=\$4.00

Making a squeegee.

Ok by now you all are going "hey this is fine as far as it goes but I need a squeegee too don't I?" and you would be right. On the commercial models, most have a threaded reservoir that accepts a screw on Mason Jar lid[®]. This allows us to insert a rubber plate with holes in it, this scrapes all the excess finish off the shaft and keeps it in the tank.

This does a number of things for you, first of all it is an elegant looking solution and there is no dripping and no uneven run off that could dry into odd drips on your shaft. In fact the shaft is dry almost instantly and only slightly tacky for a short while before completely drying. The other thing this does is keep the finish in the tank from evaporating it's thinning agent too quickly which is also a good thing as you do not have to inhale so much of it.

Now this would be a good solution if I could do it but I have not found a way to do so on my own. Finding a pipe adapter with that thread style and size would be difficult and probably expensive not to mention having to replace those rubbers often as they wear out fast (I only know of an American distributor for them so it becomes expense on top of expense).



What I did was to cut up a section of Mountain bike inner tube into about 4 x 4 inch sections with a 5/16th hole in the middle and lay that over the top of the tube reservoir and clamp it in place with a screw band clamp or a couple of winds with a rubber band.

I do not think these will last as long as the rubbers you buy for the commercial dippers but at 3 bucks for 8-10 of them, I doubt if that will be a problem and I can go to any place that sells bike supplies to find them so I do not have to order them from a distributor. For that matter any sort of thick rubber that you can cut into a 4 x 4 square will work so old truck inner tubes or the like is probably fine.

[Back To The DIY Page](#)

© 1999 Renny-James Bachner. All rights reserved. [suggestions and submissions](#)

Next, use a permanent marker or ball point pen and mark the board as shown on Figure 2. You don't have to mark the string path I've shown, but I do just in case I forget which way to wind the strands on the jig.

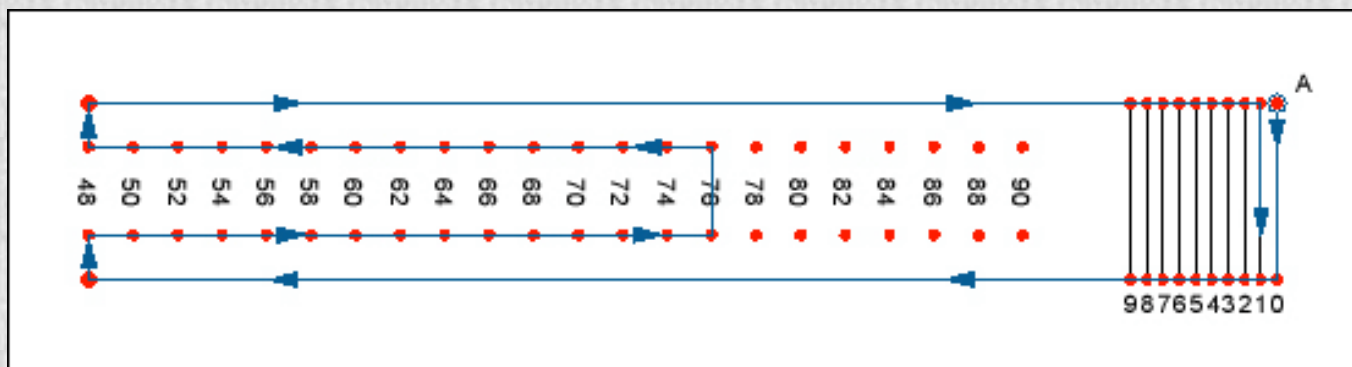

Now you're ready to make the bowstring. For this you'll need the following materials:

Dacron B-50 or other such suitable materials as Fast Flight or linen and hemp thread will work well but these instructions are for B50.

The other materials have different properties and will require more or less strands to do the job based on their respective breaking strengths. However this is beyond the scope of these instructions, note also that the use of fast flight on bows that are not made for it should be avoided at all costs, unless you want to break your bow.

I recommend at least two different colors of string. It makes for a prettier string and is easier to keep track of what you're doing while making the string.

You will need wax to lubricate the string and hold everything together while you do the braiding. Some like beeswax or specifically string makers wax but I prefer a plain soft string wax for polyester strings.

A spool of monofilament or nylon serving line and a server.

These supplies can be ordered from most archery supply mail order companies or purchased at your local dealers. In Canada I recommend [Heights archery supply](#)

Next, you'll need to decide if you want to make a two ply or three ply string. A two ply string is made from two bundles of twisted strands while a three ply string uses three bundles. A two ply string is easier to make and for this article I have chosen to illustrate the two ply process.

How many strands do you need for your B50 bowstring.

40 to 50 LB range	12 strands
50 to 70 LB range	14 strands
70 to 80 LB range	18 strands

Ok Now say you have a 50 pound bow, you will need 12 strands of b-50. I will suggest 2 bundles of 6 strands in colors that work well together and allow for easy identification.

There is of course the choice to make your bowstring with more than 2 bundles and it is just as easy to

do but for now we will stick to 2. If you want a quick explanation of how to do more than 2 bundles then read [here](#).

Be forewarned; some of the dark colors in b50 run so white and red for instance will become a red and pink string or black and white makes a grey and black string.

to figure out how long to make the strands, take the amo length of your bow, say my recurve at 64 inches, subtract 3 inches for a longbow or 4 inches for a recurve. I am left with 60 inches, then you figure in the length of the extra for braids. I started doing this with 8 inches extra but I have found it insufficient so I doubled it. 16 inches will give you about 8 inches of tail on each end to braid in to the loops.

Note:This has already been figured into the design of the jig so you do not have to worry about it. Just wrap your string to the length you need. (for a 60 inch string, wrap to the 60 inch position, you will get a bundle 76 inches long.)

AMO - 3 or 4 inches = bowstring + 16 inches = strand length.
therefore, $64 - 4 = 60 + 16 = 76$ inches.

Now, Grab your jig and tie the end of the string to the top left-hand nail (Position A) as shown in Figure 2. If your desired string is, as it is for me, 60 inches long, find the 60 inch position marked on the board and start winding the strands onto the jig until you have 6 strands of string on the jig. when you have done that, run the spool to the next pin as if to wind another strand and carry it across to the other pin. You're not going to wind another but when you cut the string it keeps all the strands at the correct length.

Now cut the strands with a sharp knife or razor blade right down the center line between the top nails.

Carefully pull the bundle off the jig making sure that the ends of the strings don't move. You'll notice that the ends of each strand is slightly shorter than the others as illustrated in Figure 3. Staggering the string ends helps to lock each strand in place as you make the bowstring loops. Set this bundle aside and repeat the process using a different color of B-50 Dacron string.

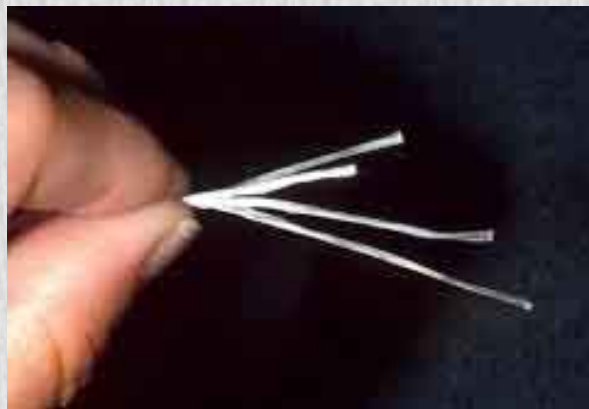

Wax both ends of each string bundle for about 10 inches. You may have to warm the wax so that it will stick to the strings. Use a candle or alcohol burner. Thoroughly work the wax into the bundles.

Lay both bundles side by side so that the longest strand in each bundle is aligned with the other then lay the two bundles on the ruler you marked on your jig. Grasp both bundles about 8 inches back from the ends. Hold the bundles between your thumb and forefinger as shown in Figure 4.

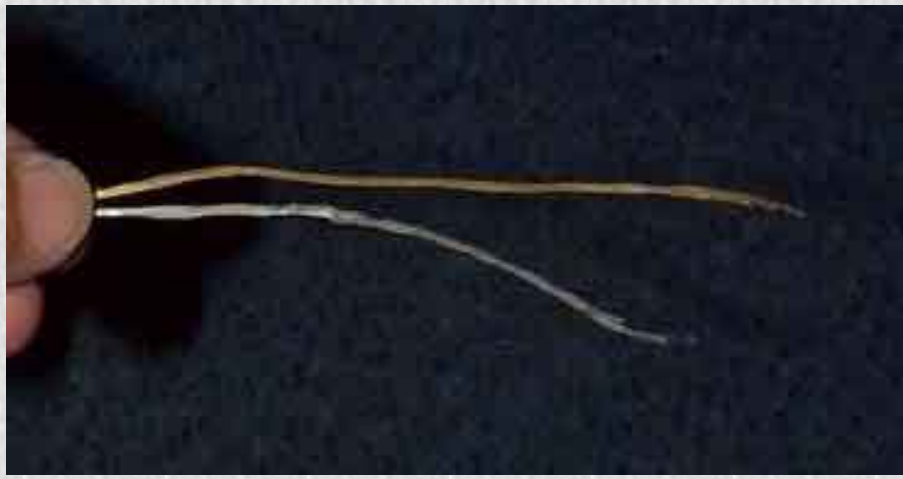

Using your other hand, twist the top bundle six or seven times in a counterclockwise direction (twist away from your body). Now take the twisted bundle and rotate it over the top of the bottom bundle (towards your body). The bottom bundle is now on top and vice versa. See Figure 5. Keep repeating this twisting and rotating process until you have braided enough to form the loop for the top limb on your bow. The width of this loop will vary as does width of different bow limbs. The loop should be wide enough so that it will slide down the bow limb 5 or 6 inches when the bow is unstrung.

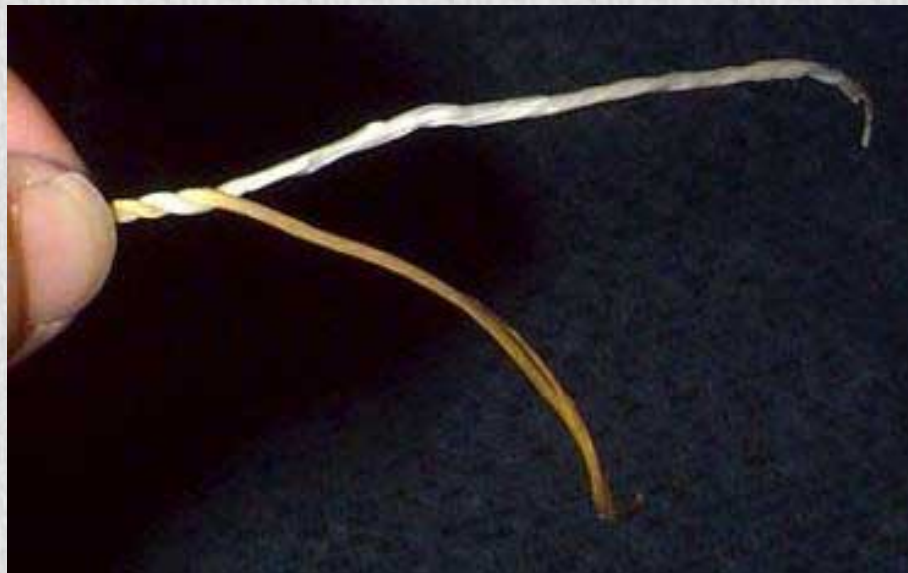

Form the loop as shown in Figure 6. Make sure you align the bundles as shown (same color over same color). Grasp the bundles at the bottom of the loop and twist the two bundles of same color together. Figure 6 shows white twisted onto white forming one large white bundle and yellow twisted onto yellow forming one large yellow bundle.

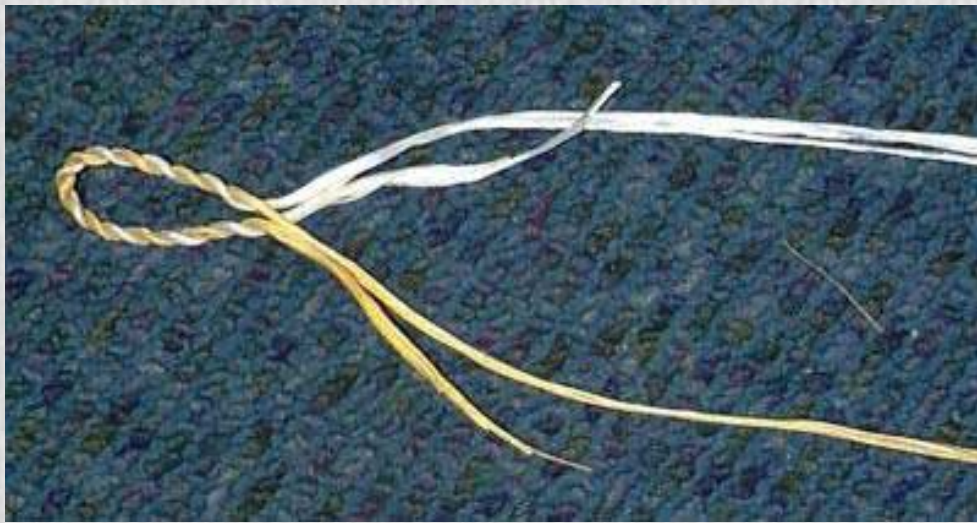

Holding these two bundles between the thumb and forefinger, perform the same twisting and rotating process until the last tag end of the strings have been braided into the bowstring. Your finished loop should look like that shown in Figure 7.



After finishing the top loop, separate both bundles all the way down to the bottom. Take your 8 inch measurement at the bottom of the bundles and repeat the whole process again just as you did when forming the top loop. When braiding the bottom loop you may have to stop occasionally to separate the bundles. The bottom loop has to be just wide enough to fit over the nocks on your bottom bow limb.

Rather than forming a permanent braided bottom loop you can also choose to just braid about the last 8 to 10 inches of the bottom bundles and tie a [timber hitch](#) for your bottom loop.

Now that you have completed the loops you will need to put a twist into the bowstring. Make sure you twist the bowstring in the same direction as your braids otherwise you will untwist the loops. Put the string on your bow and adjust for proper brace height. Allow the string to stretch for a day or two or go out and shoot the bow. Remember to keep adjusting the brace height by twisting or untwisting the string until all the stretch has been worked out of the string.

More don't make my mistake advice.

This is important to remember, if you serve and nock the string prior to getting all the stretch out, your nock will be in the wrong place and you will have to redo it again. This is a pain in the butt. I would suggest that you use some of your serving material and Tie a temporary nock in place while

you stretch the string, which will greatly simplify the whole process.

With your bow strung, mark the string about where you think your nocking point will be. Mark the string again about 2 inches above the nock point and 6 inches below the nock point. This 8 inch area of the string is where you will apply the monofilament serving. Put your spool of monofilament on the serving tool and pull a few inches of line out. Now is a good time to adjust the tension of the serving tool. You want the line to come off the server with some tension so that you get a tight wrap around the bowstring. Don't use too much tension or your serving could cut through the bowstring.

Separate the bowstring at either end of the serving area and insert about 1 inch of the monofilament line through the bowstring. Begin wrapping the monofilament around the bowstring while keeping the loose end under the serving wrap. Keep wrapping the monofilament around the bowstring until you are about 1/4 inch from the end of the serving area.

Cut a 10 to 12 inch strand of the B-50 string. Fold the string back to form a loop at one end. Lay the string on the bowstring with the loop facing towards the end of the limb. Wrap the monofilament line over the Dacron string about 6 to 8 more times. Keep these last few wraps a little loose. When you get to the end of the serving area pull a couple of inches of monofilament off the spool and cut the line. Cut the line and insert the end of the monofilament through the loop in the Dacron string. Grasp the loose ends of the Dacron string and pull them back under the last few wraps of monofilament. This will lock the end of the monofilament under those last wraps.

Now that the bowstring is finished give it a good waxing with a quality bowstring wax. Rub the wax in thoroughly using a piece of scrap leather. Rub it hard and fast so that the wax gets hot from friction and flows into the strands of the bowstring.

Now, go out and enjoy shooting your bow, equipped with a string created by your own hands.

[Back To The DIY Page](#)

© 1999 Renny-James Bachner. All rights reserved. [suggestions and submissions](#)

How to make a bowstring with more than 2 bundles.

Written by RJ Bachner

This is really quite easy to do if you can handle 2 bundles. Remember when you started the twist that became the first loop? You pressed the two bundles between your fingers and separated the bundles just the tiniest bit so that you could work them without confusing the two. Well you do the same thing now with 3 or more bundles.

Work with 3 colors for now. You have the 3 bundles spread in your fingers and held firm. Say red, blue and green. Twist the red until tight and then right over the two others so now you have blue green red. do it again with the blue and then the green and then the red and so on. Do not mix the order during the winde or it will show in your pattern, see I told you it was easy.

Now the tricky part. finishing the loop.

Ok after you have made the loop as long as you need it to be, twist the braid as tight as you can without causing the braid to curl, the tighter the twist at this point the more resilient the loop will be to wear. Then spread the ends out between your fingers in the same manner as when you started, only now you have 6 bundles as you close the loop. Try to use the same pattern as when you started, Red, blue and green for both sets of strands. Now twist the red and over, the blue and over, the green and over and so on.

I do hope this helps, if you wanna have some fun, try more bundles, the best I have ever done was a 7 bundle of 2 threads each. it was so nice and smooth. It was a load of work but what a nice braid on the string. I do not however reccomend more than 7 braids, it will leave spaces inside the winde where the bundles do not touch. It is the way cordage works, you can do it but your string will not be stronger for it.

Ragi

[Back To The DIY Page](#)

© 1999 Renny-James Bachner. All rights reserved. [suggestions and submissions](#)

The Timber Hitch or Boyer's Knot.

By RJ Bachner

Ok Folks here is a diagram of the timber hitch, also known as the Boyer's knot.



In many cases flemish braid strings were braided with a loop at only one end, meaning that the top had a loop braided into the string and the other end was left loose. This loose end was to be tied onto the lower limb nock and left there permanently.

The knot most probably used was the Boyer's knot. I am sure that other knots were used as well but I do not have the time or resources to track down evidence of them all.

It is simple to tie and as I discovered, simple to goof up if you don't pay attention. My first time trying this knot, the knot slipped and I was hot stripped by a waxed string coming up from below. It hurts, so don't make the same mistake I did.

Ok the basic knot is a loop, right? What you do is hold the string in your left hand with a tail hanging out. The length of the tail is dictated by the knot you want to make and how short you want to make the bowstring.

Now take the tail and loop it back, making sure that the tail goes under the string and over not the other way as it is not secure nor the traditional way to tie the knot. It is this first under and over that is important as this will be pinched between string and bow where it will be held more securely and will not slip.

As the tail loops over the string, slide it back through the loop a couple of times, in the picture you can see that it is looped 3 times. This pinches the end of the string in the knot and holds everything tight and thus you have the Boyer's knot.

[Back To The DIY Page](#)

© 1999 Renny-James Bachner. All rights reserved. [suggestions and submissions](#)

How to tie on a string nock

By Jason Farrell and RJ Bachner

Greetings, so you have wandered in and are now curious as to what the heck I am nattering on about here. Well we are going to teach you how to tie a nocking point to your string.

Why you ask, would I do that, never mind be so foolish as to recommend someone else do that? Firstly String nocks are significantly lighter than the big brass jobbies that we normally use to nock the string with. As with all things in archery, lighter weight usually translates into more speed and this is no exception.

I do not know how much in actual fact this will improve the speed of the arrow, I have heard figures like *An extra 15 fps* and maybe that is true, I don't know. Someday I will chronograph it and see but for now let us just close our eyes and imagine it is significant, OK?

Now then, chances are you've tied a half-knot before... what is a half-knot?? Well we've all tied our shoes, tied bows on gifts; if you were lucky, tied people up while playing games as a child. A half-knot is simply the first half of a knot...

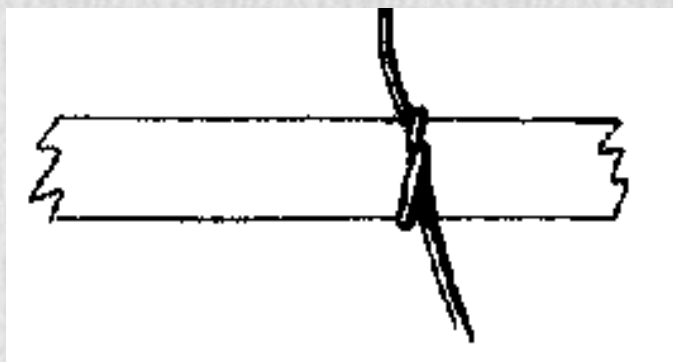

it's what you do with the other half that makes a knot complete... for now we don't need the second half.

To tie a "tied on string nock", you will need:

- Your bow
- Your bow string
- At least 2-feet of nylon string
- Bow square
- String wax
- A short piece of tape, any color

First, string your bow, and make sure you have the proper fistmail, once you've completed the String nock it can be adjusted by twisting it up or down the string, however you will want to make sure the serving is snug and not sliding or twisting under the nock point. Lay your bow on a table and you are ready to go.

There are many ways to start serving; this is my way, if you have a better one let me know. Use the bow square to find the proper location for the knocking point, remember to go at least 1/8th of an inch higher

or lower (depending on how you nock) from dead center on the square. That's where you will do your first half-knot.

Take your nock string and wrap the tape around one end. Proceed to make the half-knot around the knocking point. This will be your mantra during the process, "right over left and under" or in this case "tape over no tape and under"

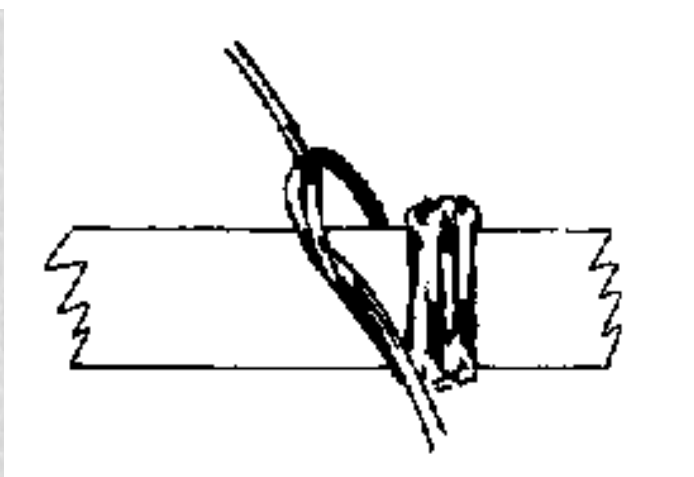
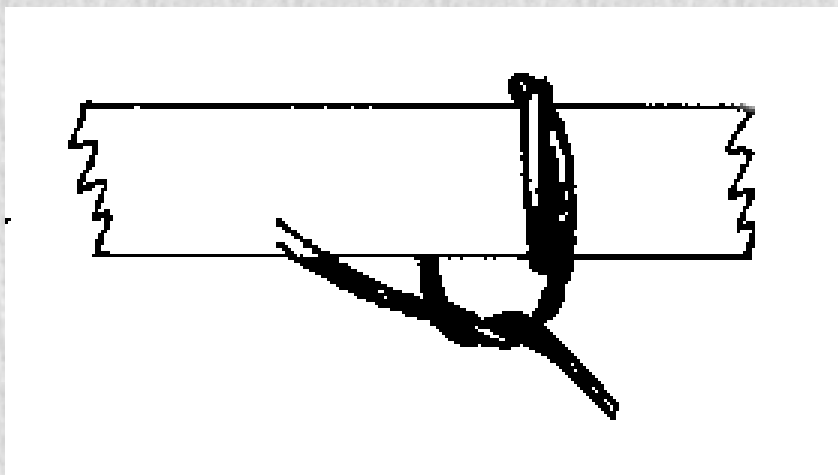

Now you flip the bow over and repeat the process again... "tape over no tape and under". Flip the bow and another half-knot... "tape over no tape and under". Flip and repeat.

You don't want to spread the knots down the string at all and no more than 3 or 5 knot widths up the string otherwise you will mess up the knocking point. What to do... just make the knots over the old ones so as to build up the thickness 2 or 3 string widths.

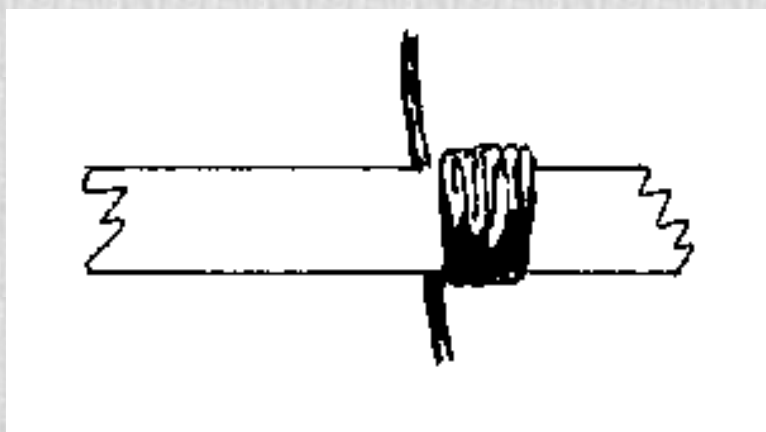

go on in this fashion until you get an nice bundle of knots..

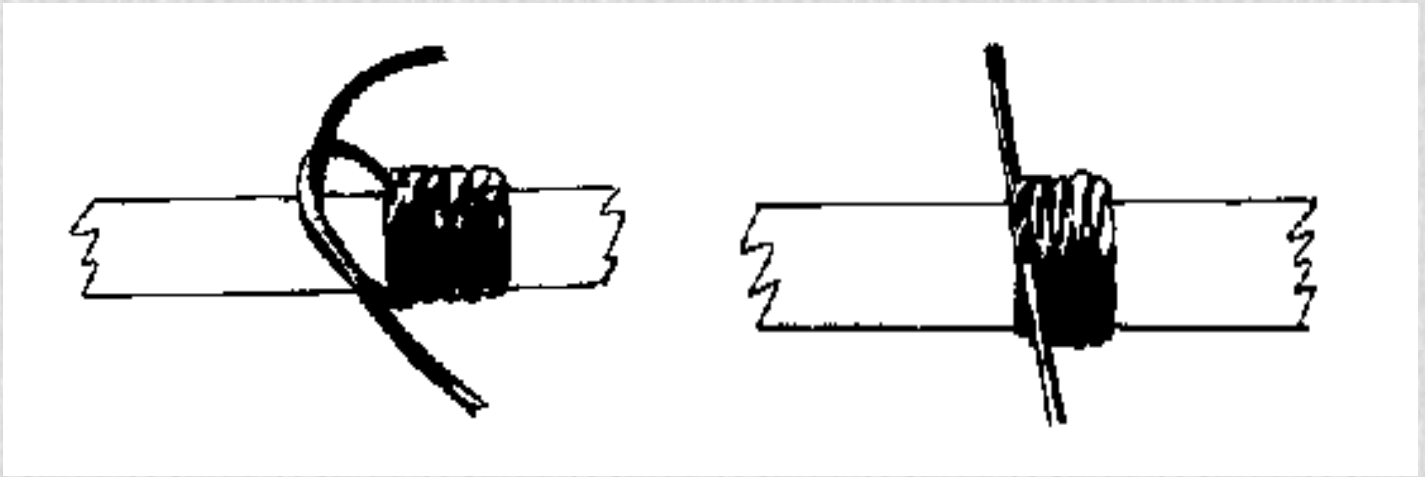

Once you get a nice bundle that you will feel comfortable with (and won't slip through the arrow's knock) you are ready to finish it up... The finishing knot is a full knot..

"tape over no tape and under" then "no tape over tape and under" flip the bow and "tape over no tape and under" then "no tape over tape and under".

Cut the ends off so that there is at least an 1/8th of an inch remaining and:

1. Apply a very generous amount of string wax and work it into the bundle, at the same time making sure that the bundle is in the right place.
2. Or put some CA glue, Super Glue, or any other contact glue on the ends so that they don't fray and the knot will not vibrate loose.

Whichever way you choose periodically check the String nock to see if it's still in place and still holding together.

[Back To The DIY Page](#)

© 1999 Renny-James Bachner. All rights reserved. [suggestions and submissions](#)

BACK QUIVER PLAN

Written by Rob DiStefano

Edited by RJ Bachner

This page was originally written by [Ron DiSteffano](#) I welcome you to visit his page in search of other usefull info.



Big, sturdy, functional, good traditional looking back quiver.

Materials:

- 4oz to 10oz quiver body leather, 23" x 19" x 18" (or your preference in size)
- 8oz to 10oz strap/bottom leather, 6" x 20"
- approximately 2 to 3 pairs of 6' boot leather laces

Tools:

- 1/8" to 3/16" hole punch (sharpened tubing, .22 cases & hammer)
- very sharp knife (razor knife works quite well)
- needle nose pliers (to help pull through the laces)
- ruler and pen

The Quiver Crafting Process

Cut out the quiver leather to your desired measurements. (This example uses 23" x 18" x 19"). Draw an edge ink line 1/4" in from, and parallel to, all four leather edges.

On the top and bottom edge ink lines, starting 1/4" in from each side, make a tick mark every 1/2". We'll call these the top/bottom edge lines

On either long (length) side, draw a line 1" in from, and parallel to, the side edge ink lines. We'll call

these parallel lines the side parallel lines.

1/2" up from the bottom edge line, make a tick mark on all four side parallel lines. Starting at the side parallel lines tick marks you just made, make a tick mark on all four side parallel lines every inch, all the way up to the top of the quiver.

The back of your quiver leather should now look like the drawing below...

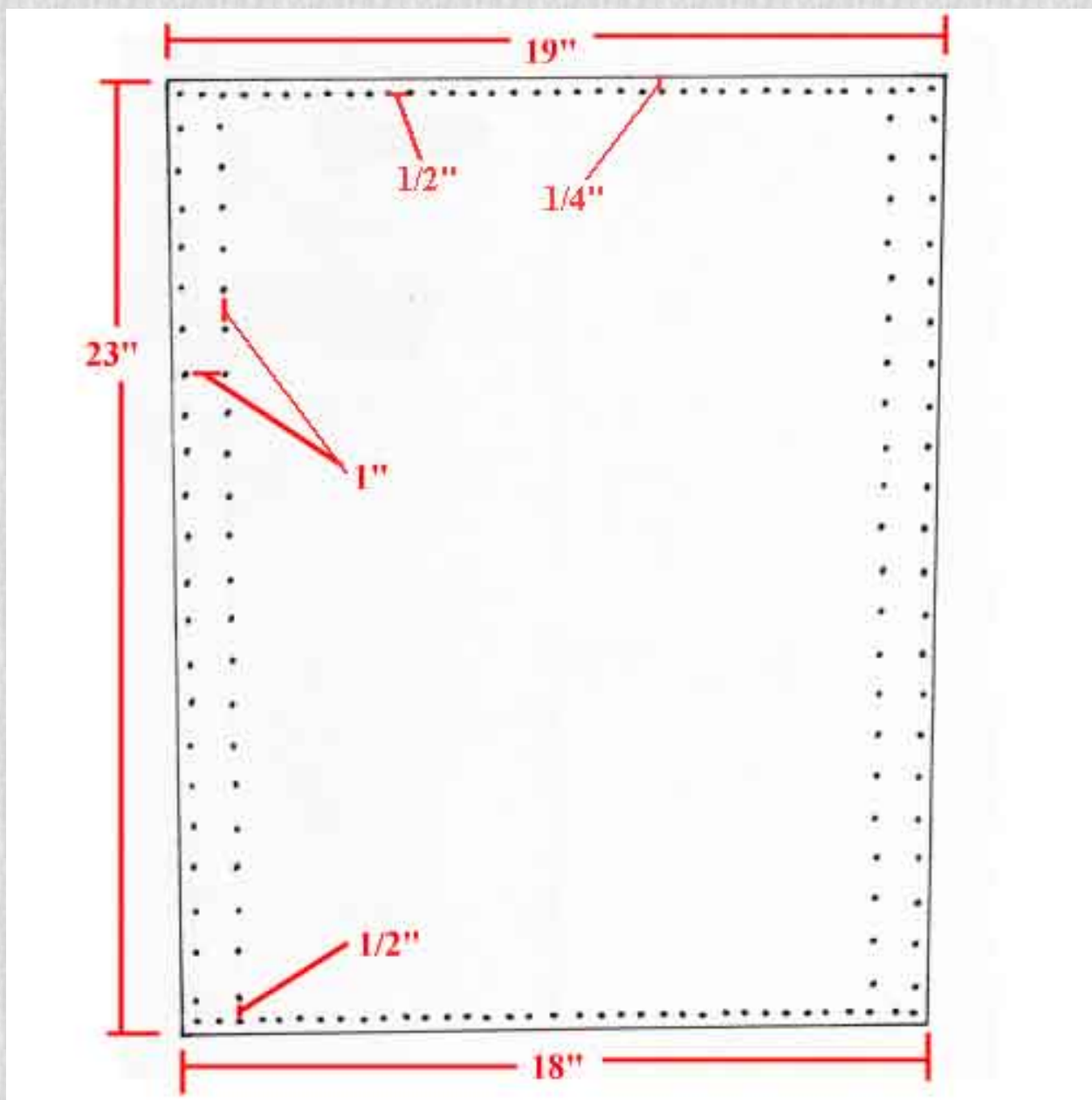

At every tick mark, punch a hole.

Take a 6' leather lace and cut both ends at a slight angle, to make it easier to fit through the holes (to make the tips really stiff, run a few drops of CYA on them!).

Roll up the leather (if your leather is quite stiff, you can use a few large rubber bands to keep it rolled up during the lacing process), overlapping the edges, aligning the side parallel line holes you just punched. Starting at the bottom, and from the outside, lace up the quiver.

Insert each end of the single lace and pull them through evenly into the inside of the quiver and then, from the inside, move straight up to the next set of holes and push them through and out. Now cross them and push them down into the quiver. Repeat lots of times! The two images below should help...



NOTE: You can see the **bottom edge line tick marks in the right image - they were NOT punched!**

Now that you've got the quiver tube laced up, before adding the bottom, we'll punch two holes for the bottom of the strap. With the quiver in front of you, with the "X" lacing up and the tube somewhat flattened into an oval, the holes will go on the left side for a right handed archer.

Punch two holes 1" apart, and about 3" up from the bottom edge. You can tie off all lace ends with single or doubled overhand knots. When lacing the bottom and top edges, I like to tie off with a single overhand knot, then saturate the knot with CYA and cut off the ends close when cured.

Here's the idea behind the straps...

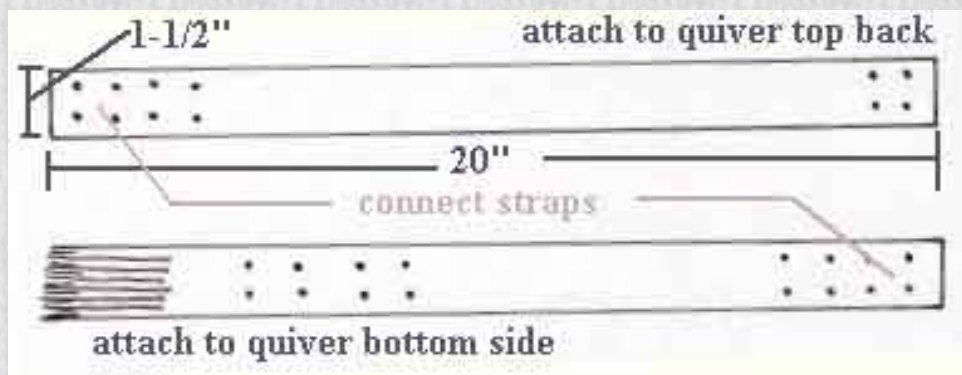



Adjust the overlap to fit you!

Ok that is how the design originally worked and many folks like it that way, I do not. It never worked for me and was always drifting so what I have done is modify the design somewhat by adding a wider shoulder strap with a ring on the end. The 2 bottom straps can be placed on the quiver, one to each side, so that it becomes more secure and adjustable. I have used this design for years now and I have no complaints.

By making the two straps with buttons instead of rivets, you can have it on and off in a jiffy.

Note where the thongs meet the strap, they are not tied but threaded through and held by the snugness of the assembly, this makes them quite adjustable.



The bottom...

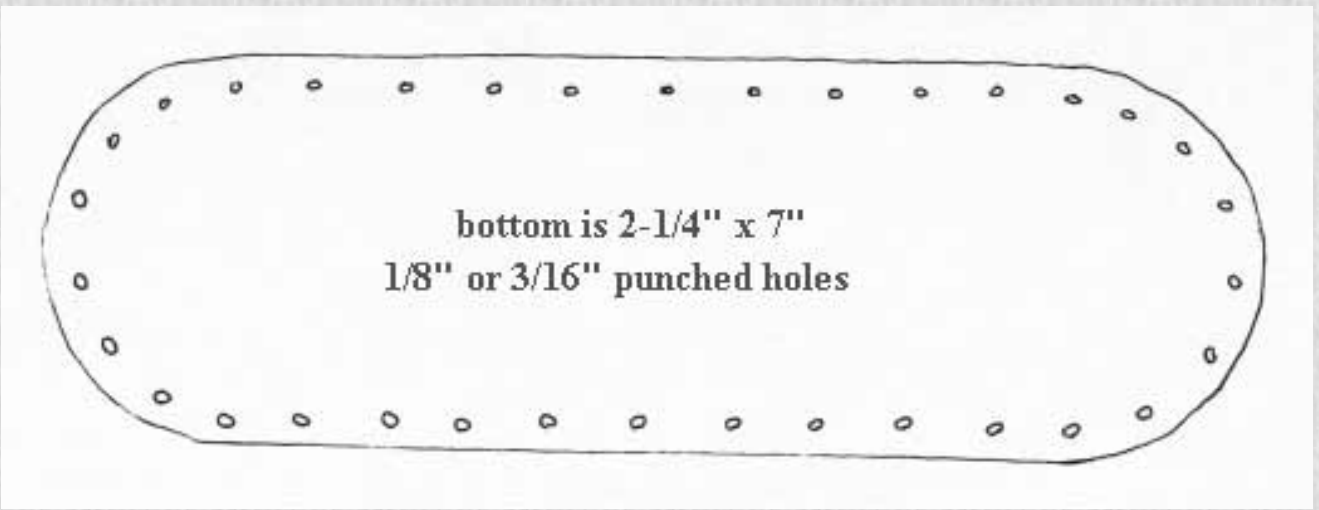

On the right is the quiver mouth, with a twisted pair of laces running from back to front, acting as a compartment separator. There are LOTS of options you can add to this basic, sturdy, very functional back quiver. Customize it as you like!

[Back To The DIY Page](#)

© 1999 Renny-James Bachner. All rights reserved. [suggestions and submissions](#)

DIY Archery Suppliers

Written by RJ Bachner

One thing I have mentioned over and over is the lack of Canadian suppliers for DIY projects but that is not to say that there are none out there. There are online sources in eastern, central and western Canada, probably more than I know of as well but these are the ones I know.

Traditional archery suppliers

Canadian Suppliers

- Tele Transactions Traditional Archery Supplies

In Quebec

(450) 961-9543

[Gabriel Pigeon](#)

- Heights Archery Range

In Saskatchewan

(204) 832-4421

[Ron Minion](#)

- [Canadian Traditional Archery](#)

In Alberta

(780) 998-2770

service@traditionarchery.com

US Suppliers

- [Bingham Projects](#); to make your own wood laminate bows.

(801) 399-3470

info@binghamprojects.com

- [BowsOnline](#) a good place to get yer bows at often cut rate prices.

bows@bowsonline.com

- [Diana's Shaft Shop](#)

(860) 564-6726

[Ed Breyette](#)

- [FS Discount Archery](#)

1-800-824-8261

- [Three Rivers Archery](#)

(219) 587-9501

info@3riversarchery.com

[Back To The DIY Page](#)

© 1999 Renny-James Bachner. All rights reserved. [suggestions and submissions](#)



3Rivers Archery

WORLD'S LARGEST TRADITIONAL-PRIMITIVE ARCHERY SUPPLIER

“Traditional Archery Excellence”

[Shop Now](#)

[What's Hot](#)

[Trophy Room](#)

[Tomahawk Bows](#)

[3D Shoots](#)

[Shipping Info](#)

[About Us](#)

[3Rivers News](#)

[FAQ](#)

search

Brought to you by:

Bowsite.com

Diana's Shaft Shop

Products Services News Order Home Contact Us

Main Menu

Diana & Edward Breyette Proprietors

We specialize in Traditional Archery Equipment and Supplies Specializing in Bows, arrows and equipment useful in the SCA, Ren-Faires, etc. As well as Hunting and Competition Shooting.

Our Mission

Archery should be FUN! Not Expensive. Life is expensive enough so why pay more than you have to. We produce our own line of Greyledge Finished bows and unfinished bow kits at the lowest possible cost to you without compromising Quality.

Copyright © 1998 Diana's Shaft Shop
For content comments or questions, contact the [Web Master](#)
Revised: 25 October 2000