



This is a digital copy of a book that was preserved for generations on library shelves before it was carefully scanned by Google as part of a project to make the world's books discoverable online.

It has survived long enough for the copyright to expire and the book to enter the public domain. A public domain book is one that was never subject to copyright or whose legal copyright term has expired. Whether a book is in the public domain may vary country to country. Public domain books are our gateways to the past, representing a wealth of history, culture and knowledge that's often difficult to discover.

Marks, notations and other marginalia present in the original volume will appear in this file - a reminder of this book's long journey from the publisher to a library and finally to you.

Usage guidelines

Google is proud to partner with libraries to digitize public domain materials and make them widely accessible. Public domain books belong to the public and we are merely their custodians. Nevertheless, this work is expensive, so in order to keep providing this resource, we have taken steps to prevent abuse by commercial parties, including placing technical restrictions on automated querying.

We also ask that you:

- + *Make non-commercial use of the files* We designed Google Book Search for use by individuals, and we request that you use these files for personal, non-commercial purposes.
- + *Refrain from automated querying* Do not send automated queries of any sort to Google's system: If you are conducting research on machine translation, optical character recognition or other areas where access to a large amount of text is helpful, please contact us. We encourage the use of public domain materials for these purposes and may be able to help.
- + *Maintain attribution* The Google "watermark" you see on each file is essential for informing people about this project and helping them find additional materials through Google Book Search. Please do not remove it.
- + *Keep it legal* Whatever your use, remember that you are responsible for ensuring that what you are doing is legal. Do not assume that just because we believe a book is in the public domain for users in the United States, that the work is also in the public domain for users in other countries. Whether a book is still in copyright varies from country to country, and we can't offer guidance on whether any specific use of any specific book is allowed. Please do not assume that a book's appearance in Google Book Search means it can be used in any manner anywhere in the world. Copyright infringement liability can be quite severe.

About Google Book Search

Google's mission is to organize the world's information and to make it universally accessible and useful. Google Book Search helps readers discover the world's books while helping authors and publishers reach new audiences. You can search through the full text of this book on the web at <http://books.google.com/>

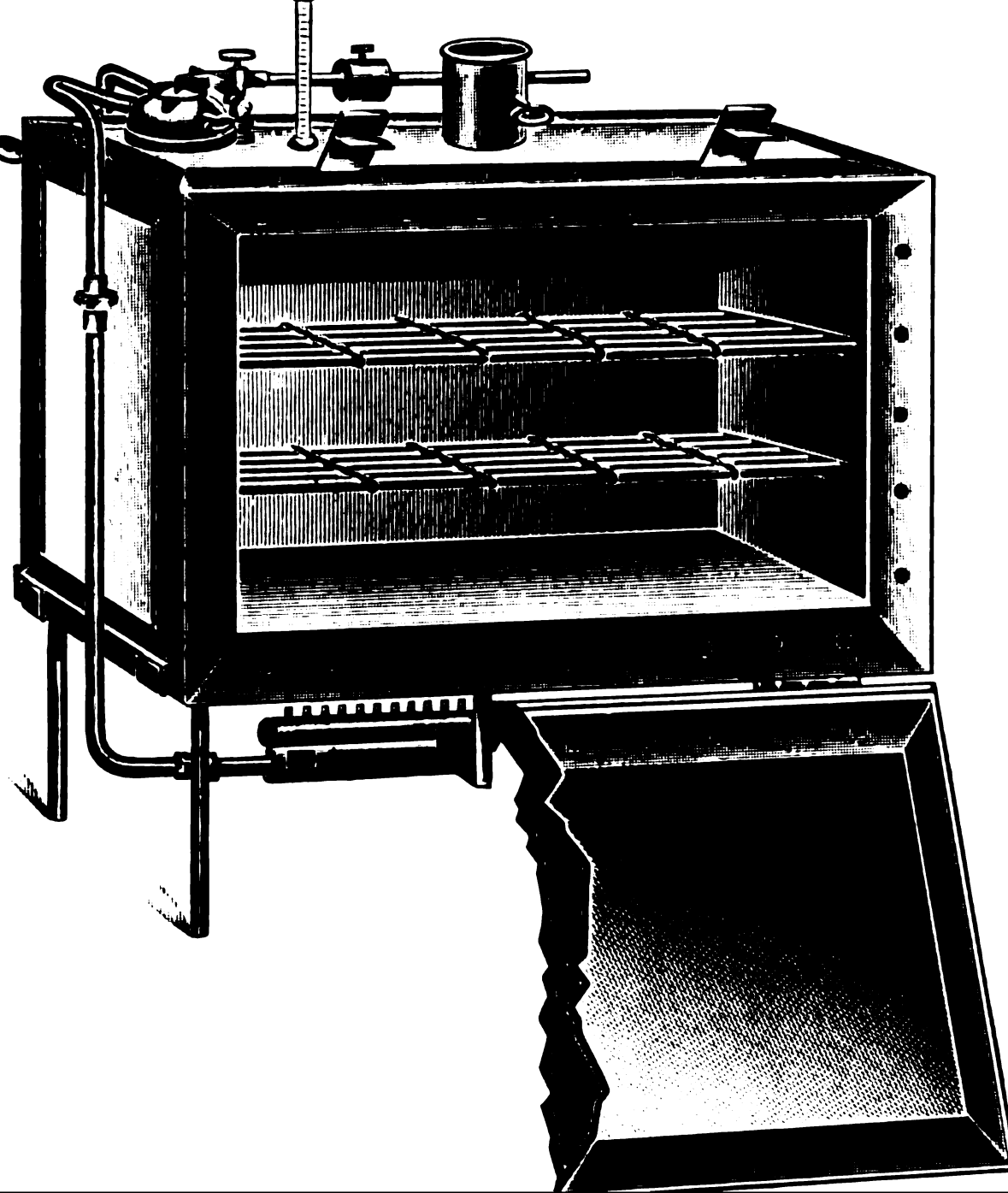

*Practical bacteriology, microbiology
and serum therapy (medical and ...*

Albert Besson, Harold John Hutchens

7.3 104

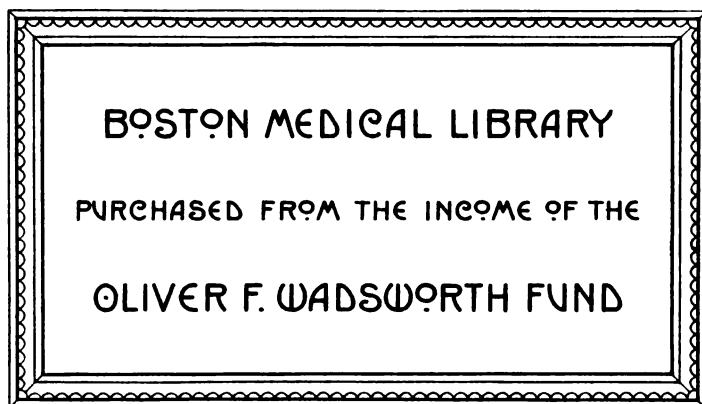

**PRACTICAL BACTERIOLOGY, MICROBIOLOGY
AND SERUM THERAPY**

(MEDICAL AND VETERINARY)

**PRACTICAL
BACTERIOLOGY, MICROBIOLOGY
AND SERUM THERAPY**

(MEDICAL AND VETERINARY)

A TEXT BOOK FOR LABORATORY USE

BY

DR. A. BESSON

FORMERLY DIRECTOR OF BACTERIOLOGICAL LABORATORIES OF THE MILITARY
HOSPITALS OF FRANCE AND OF THE PÉAN HOSPITAL.
LAUREATE OF THE FRENCH INSTITUTE

TRANSLATED

AND ADAPTED FROM THE FIFTH FRENCH EDITION

BY

H. J. HUTCHENS, D.S.O.

M.A., M.R.C.S., L.R.C.P., D.P.H. (OXFORD)

HEATH PROFESSOR OF COMPARATIVE PATHOLOGY AND BACTERIOLOGY OF THE
UNIVERSITY OF DURHAM: FORMERLY AN ASSISTANT SCIENTIFIC
INVESTIGATOR, ROYAL COMMISSION ON TUBERCULOSIS

WITH 416 ILLUSTRATIONS, 149 OF WHICH ARE COLOURED

LONGMANS, GREEN, AND CO.

39 PATERNOSTER ROW, LONDON

NEW YORK, BOMBAY, AND CALCUTTA

1913

All rights reserved

12973 Wed.

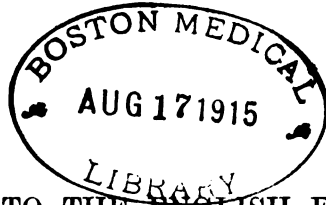

PREFACE TO THE ENGLISH EDITION.

So far as the aim and scope of the book are concerned they are sufficiently described in the Author's prefaces. It remains to be said that the lack of a similar text book in English, at once sufficiently simple to put into the hands of the beginner and at the same time sufficiently advanced to be of service to the more experienced observer, together with the evident popularity of Dr. Besson's work in French speaking countries, seems to be sufficient justification for preparing the present translation.

A mere translation however of a book dealing with so rapidly advancing a science as Microbiology would have been hardly satisfactory, hence an attempt has been made to bring it up to date by incorporating matter which has appeared since the French edition went to press.

As regards the translation itself the original text has been followed as closely as possible, but the aim throughout has been to reproduce the sense rather than the actual words.

The alterations which have been made may be included under two heads, namely: alterations in the text and alterations in the arrangement of the text. With two exceptions the whole of the French text has been followed. In Chap. VII. the theory of the Microscope has been rewritten as, generally speaking, the Student seems to possess but a very limited knowledge of the instrument and it was thought that an amplification of the French text would be useful. I wish to thank Mr. A. S. Percival, Senior Surgeon to the Eye Infirmary, Newcastle upon Tyne, for the help he has given me in this part of the subject. Chaps. XXV., XXVI., and XXVII. dealing with the Paratyphoid bacilli have also been rewritten in view of the work of the Royal Army Medical Corps in India and of Dr. F. A. Bainbridge in England.

There are many notes and additions. Thus for instance it was found necessary to incorporate the important results obtained by the Royal Commission on Tuberculosis. All such notes and additions are clearly indicated either by a footnote or by being enclosed within square brackets. It should be said also that in a few cases where the authorities were in favour of a different nomenclature from that until recently in use the new names have been substituted thus *Discomyces* appears as the generic name in place of *Streptothrix*.

The arrangement of the text in the translation varies from that of the original in some respects. In the first place the subject matter has been divided into seven Parts instead of three. Secondly, the arrangement of the Parts has been subjected to some modification. To take the Bacteria for example it seemed that in a book intended for use in the laboratory it might be an advantage if these organisms were arranged morphologically and then subdivided according to their staining reactions and cultural characteristics. The plan adopted can be readily seen by a reference to the Table of Contents. Of course no classification is perfect and therefore free from criticism but after a good deal of consideration it was felt that practical usefulness merited the attempt.

Reference to any particular point will present, I hope, no difficulty. In addition to an Index and a very full Table of Contents, a summary of the subject matter heads the various Chapters. These of course are quite independent of the French edition.

The illustrations have been carefully revised. Many of them are new though illustrating familiar subjects and were drawn by my former laboratory attendant, Mr. H. Boot, under my supervision from preparations in my laboratory. Some were drawn by Mr. Richard Muir. For others I am indebted to the courtesy of the Controller of His Majesty's Stationery Office, of Professor G. H. F. Nuttall, F.R.S., of Dr. H. G. Adamson, and of the Publishers of Mense's *Handbuch der Tropenkrankheiten*. Miss M. V. Lebour, M.Sc. of the Zoological Department of the University of Leeds kindly undertook to redraw the whole of the line drawings.

In the preparation of this translation I wish to acknowledge my very particular indebtedness to Professor G. A. Lebour, M.A., D.Sc. who has given me at all times most invaluable assistance. To my former colleague Mr. C. F. Fox who had charge of the records of the Royal Commission on Tuberculosis I owe many thanks for the considerable care with which he undertook the thankless task of reading over the whole of the MS. before it went to press and for revising the proofs.

H. J. HUTCHENS.

Newcastle upon Tyne,
March 31st, 1913.

PREFACE TO THE FIFTH FRENCH EDITION.

RECENT advances in Microbiology have necessitated an entire revision of the text. While still retaining its original form most of the chapters have been recast and much new matter has been incorporated.

The plan adopted when the book was first written of omitting all discussion upon matters of theory has been adhered to but it has nevertheless been thought desirable to include a Chapter on Immunity and the Properties of Immune Serums. The object of this has been to explain as clearly and simply as possible the principles underlying the phenomena of agglutination, of the fixation of the complement and the opsonic index and to describe the practical details in such a manner as to enable the Student to become familiar with the technique employed in these delicate investigations and so be in a position to appreciate the more detailed monographs.

In view of its importance in clinical diagnosis a description of the Ultra-microscope has been included.

Numerous additions and alterations have been made in the second Part. Most of the chapters have been supplemented. The serum treatment of Dysentery and of meningococcal Meningitis has been described as fully as was consistent with the scope of the work. The anaërobic micro-organisms, the paratyphoid bacilli, Sporotrichosis, Syphilis, etc. are all subjects of additions while many modifications have been introduced into the description and classification of the parasitic Protozoa, especially the *Piroplasmata*, *Leishmania* and *Trypanosomata*.

As in former editions the sole object has been to write a clear and concise account of each subject and one which will be abreast of recent knowledge retaining at the same time those characteristic features of the book which have been the subject of favourable comment both here and abroad.

A. BESSON.

15th May, 1911.

PREFACE TO THE FIRST FRENCH EDITION.

So important a place does Microbiology now occupy in the medical curriculum that not only are laboratories fully equipped for research and teaching to be found in all medical Schools, but the Student on leaving his School should have at least sufficient knowledge of the subject to carry out for himself the more simple investigations, such, for instance, as the recognition of the tubercle bacillus and the detection of the diphtheria bacillus.

The present work has been designed purely as a laboratory guide, the one object constantly in view in its preparation having been to make it a true *vade mecum*—a book which would both direct the beginner step by step and, at the same time, afford to the more skilled worker such assistance as would enable him to pursue his researches in a profitable direction.

My experience as a Teacher of Microbiology and as a Director of laboratories has I venture to think given me the qualifications necessary for the task in hand.

All matters of theory and all references to original sources have been studiously avoided since adequate information upon these matters is forthcoming in the many excellent Text books of Bacteriology.

In the first Part of the book the methods applicable to micro-organisms in general are detailed and while in each chapter a number of methods, all of which have been recommended by various authorities, are described, emphasis is laid upon those with which I have obtained the most satisfactory results and which I feel may confidently be recommended to the beginner.

The second Part is concerned with a description of the methods most suitable to the various different micro-organisms. The Bacteria are described first and then the parasitic Fungi and Protozoa the importance of which, however considerable it now may be, threatens to occupy an even greater place in the Pathology of the future.

The third Part which completes the book is devoted to a short account of the methods available for the bacteriological examination of water and air.

Much care has been bestowed upon the illustrations, and in order that the figures may be of as much use as possible to the Student in interpreting his own results they were drawn and coloured by myself from my own preparations and faithfully represent the appearances which should be obtained if the directions in the text are carefully followed.

I wish to take this opportunity of expressing my thanks to those of my Teachers to whom I am indebted for my instruction in the subject; I have drawn largely upon them and should this book be received with some favour I shall be not unmindful of those to whom the credit is due.

A. BESSON.

15th October, 1897.

CONTENTS.

PART I. GENERAL TECHNIQUE.

| CHAP. | PAGE |
|---|------|
| I. Sterilization. | |
| <i>Introduction</i> , - - - - - | 3 |
| <i>Section I. Sterilization by dry heat</i> , - - - - - | 4 |
| (1) Sterilization in a naked flame, p. 4. (2) Sterilization by hot air, p. 4. | |
| <i>Section II. Sterilization by moist heat</i> , - - - - - | 7 |
| (1) Sterilization in steam at 100°C., p. 7. (2) Sterilization in steam under pressure, p. 9. (3) Sterilization by discontinuous heating, p. 12. | |
| <i>Section III. Sterilization by filtration</i> , - - - - - | 14 |
| (1) Filtration of water, p. 15. (2) Filtration of culture media, p. 18. (3) The filtration of small quantities of liquid, p. 24. | |
| <i>Section IV. Sterilization by antiseptics</i> , - - - - - | 26 |
| II. Culture media. | |
| <i>Introduction</i> , - - - - - | 28 |
| <i>Section I. Liquid media</i> , - - - - - | 30 |
| (1) Media made from animal tissues and fluids, p. 30. (2) Media made from vegetable tissues, p. 37. (3) Synthetic media, p. 38. | |
| <i>Section II. Solid media</i> , - - - - - | 39 |
| (1) Gelatin media, p. 39. (2) Agar media, p. 42. (3) Media made from albuminous fluids and tissues, p. 45. (4) Vegetable media, p. 55. (5) Coloured media, p. 56. | |
| III. Incubators. | |
| <i>Introduction</i> , - - - - - | 58 |
| <i>Section I. Devices for automatically regulating the temperature of incubators</i> , - - - - - | 59 |
| <i>Section II. Incubators heated by coal gas</i> , - - - - - | 61 |
| <i>Section III. Incubators heated by electricity</i> , - - - - - | 65 |
| <i>Section IV. Incubators heated by petrol, gasoline, or petroleum oil</i> , - - - - - | 66 |

IV. The methods of sowing and cultivating aërobic organisms.

| | |
|---|----|
| <i>Introduction</i> , - - - - - | 67 |
| <i>Section I. Instruments used for sowing cultures</i> , - - - | 67 |
| <i>Section II. The methods of sowing cultures</i> , - - - | 70 |
| <i>Section III. Conditions essential to satisfactory growth</i> , - | 72 |
| <i>Section IV. The examination of cultures</i> , - - - - | 73 |
| <i>Section V. The methods of storing cultures</i> , - - - - | 75 |

V. The isolation of aërobic micro-organisms in pure culture.

| | |
|---|----|
| <i>Introduction</i> , - - - - - | 76 |
| <i>Section I. Mechanical methods</i> , - - - - - | 76 |
| (1) Isolation by dilution, p. 76. (2) Isolation by dissemination, p. 77. | |
| <i>Section II. Biological methods</i> , - - - - - | 83 |
| (1) Heat, p. 84. (2) Cultivation at the optimum temperature, p. 84. (3) Cultivation on special media, p. 85. (4) Animal inoculation, p. 85. | |

VI. The cultivation and isolation of anaërobic micro-organisms.

| | |
|--|-----|
| <i>Introduction</i> , - - - - - | 87 |
| <i>Section I. The methods of abstracting air from culture media</i> , - - - - - | 87 |
| (1) By boiling, p. 87. (2) By displacing the air with an inert gas, p. 88. (3) By absorbing the oxygen, p. 89. (4) By the use of a vacuum, p. 90. (5) Tests for oxygen, p. 92. | |
| <i>Section II. The cultivation of anaërobic organisms</i> , - - - | 92 |
| (1) In liquid media, p. 92. (2) In solid media, p. 99. | |
| <i>Section III. The isolation of anaërobic organisms</i> , - - - | 101 |
| (1) Plate method, p. 101. (2) Tube method, p. 103. | |
| <i>Section IV. Vacuum incubators</i> , - - - - - | 104 |

VII. The Microscope.

| | |
|--|-----|
| <i>Introduction</i> , - - - - - | 106 |
| <i>Section I. The microscope stand</i> , - - - - - | 106 |
| <i>Section II. The optical parts of the microscope</i> , - - - | 107 |
| A. The objectives, p. 107. (1) Magnification, p. 107. (2) Spherical aberration, p. 110. (3) Angular aperture, p. 112. (4) Numerical aperture, p. 112. (5) Resolving power, p. 112. (6) Brightness of image, p. 113. (7) Definition, p. 114. (8) Chromatic aberration, p. 114. (9) Flatness of image, p. 115. B. The eyepieces, p. 116. | |
| <i>Section III. The care of the microscope</i> , - - - - - | 117 |
| <i>Section IV. The method of using the microscope</i> , - - - | 118 |

| | |
|---|-----|
| <i>Section V. The measurement of microscopical objects, - -</i> | 121 |
| (1) The experimental determination of the magnification produced by a system of lenses, p. 121. (2) The measurement of objects under the microscope, p. 122. | |
| <i>Section VI. Dark-ground illumination, - - - - -</i> | 123 |
| (1) The application of dark-ground illumination to micro-biology, p. 124. (2) The construction of the dark-ground illuminator, p. 124. (3) The method of using the instrument, p. 125. | |
| VIII. The microscopical examination of cultures of micro-organisms. | |
| <i>Introduction, - - - - -</i> | 130 |
| <i>Section I. The preparation of slides and cover-glasses, - -</i> | 130 |
| <i>Section II. The examination of unstained preparations, -</i> | 131 |
| (1) The examination of a culture on an ordinary slide, p. 132. (2) Hanging-drop preparations, p. 132. | |
| <i>Section III. The examination of stained preparations, - -</i> | 135 |
| (1) Staining solutions, p. 137. (2) Simple staining, p. 140. (3) Gram's stain, p. 142. (4) Claudius' method, p. 144. | |
| IX. The staining of spores, capsules and flagella. The study of the motility of bacteria. | |
| <i>Section I. Spores, - - - - -</i> | 145 |
| (1) The examination of unstained preparations, p. 145. (2) The staining of spores, p. 146. | |
| <i>Section II. The staining of capsules, - - - - -</i> | 147 |
| <i>Section III. The staining of flagella, - - - - -</i> | 148 |
| (1) The staining of flagella in living organisms, p. 148. (2) The staining of flagella in dried preparations, p. 149. | |
| <i>Section IV. The methods of studying the motility of micro-organisms, - - - - -</i> | 154 |
| X. Animal inoculation. | |
| <i>Section I. The selection of animals for inoculation, - -</i> | 156 |
| <i>Section II. The keeping of animals, - - - - -</i> | 157 |
| <i>Section III. The spontaneous diseases of experimental animals, - - - - -</i> | 159 |
| <i>Section IV. The handling of experimental animals, - -</i> | 160 |
| <i>Section V. Experimental inoculations, - - - - -</i> | 165 |
| (1) Instruments, p. 165. (2) Preparation of the material for inoculation, p. 169. (3) Technique of inoculation, p. 170. | |
| <i>Section VI. Observations to be made on inoculated animals,</i> | 182 |
| XI. Post mortem examinations. | |
| <i>Introduction, - - - - -</i> | 184 |
| (1) Instruments, p. 184. (2) Preliminary operations, p. 185. (3) Examination of the external surface of the carcase, p. 185. (4) Examination of the internal organs, p. 185. (5) Removal of tissues for histological examination, p. 188. | |

| | |
|---|-----|
| XII. The collection of material for bacteriological examination. | 191 |
| (1) Hair, p. 191. (2) Skin, p. 191. (3) Sputum, p. 191. (4) Blood, p. 192; The collection of serum, p. 195. (5) Pharyngeal exudates, p. 197. (6) Abscesses, p. 197. (7) Aqueous humour, p. 197. (8) Pleural and pulmonary exudates, p. 198. (9) Ascitic fluid, p. 198. (10) Tumours and lymphatic glands, p. 198. (11) Splenic puncture, p. 198; Splenectomy, p. 199. (12) Lumbar puncture, p. 199. (13) Milk, p. 201. (14) Urine, p. 201. (15) Stools, p. 202. | |

XIII. The bacteriological examination of fluids and tissues.

| | |
|---|-----|
| <i>Section I. Film preparations,</i> | 203 |
| (1) Unstained preparations, p. 203. (2) Stained preparations: <i>A.</i> Preparation of films, p. 204. <i>B.</i> Staining methods—(i) Simple staining, p. 205. (ii) Differential staining, p. 207. | |
| <i>Section II. Histological preparations,</i> | 211 |
| (1) Instruments, p. 211. (2) Freezing methods, p. 212. (3) Paraffin embedding methods, p. 212. (4) Preliminary treatment of sections, p. 215. (5) The staining of sections: <i>A.</i> Simple staining, p. 216. <i>B.</i> Differential staining, p. 217. | |

XIV. Immunity. The properties of immune serums.

| | |
|---|-----|
| <i>Introduction,</i> | 221 |
| The mechanism of immunity, p. 222. | |
| <i>Section I. Prophylactic and therapeutic serums,</i> | 223 |
| <i>Section II. Antitoxins,</i> | 224 |
| <i>Section III. Agglutinins,</i> | 225 |
| The mechanism of agglutination, p. 226. | |
| <i>Section IV. Bactericidal properties,</i> | 227 |
| The mechanism of bacteriolysis, p. 228; Hæmolysins, p. 230; The preparation of an hæmolytic serum, p. 230; The mechanism of hæmolysis, p. 231; The fixation of the complement, p. 232; The technique of the complement-fixation reaction, p. 233. | |
| <i>Section V. Opsonins,</i> | 239 |
| The method of determining the opsonic index, p. 240. | |

PART II. THE PATHOGENIC BACTERIA.

SUB-DIVISION I. THE NON-SPORE-BEARING, GRAM-POSITIVE, NON-ACID-FAST BACILLI.

XV. *Bacillus diphtheriæ.*

| | |
|--|-----|
| <i>Introduction,</i> | 245 |
| <i>Section I. Experimental inoculation,</i> | 247 |
| (1) The symptoms and lesions produced in animals susceptible to infection, p. 247. (2) The influence of other organisms on the clinical course of the disease, p. 249. | |
| <i>Section II. Morphology,</i> | 250 |

| | |
|--|-----|
| <i>Section III. Biological properties,</i> | 254 |
| (1) Vitality and virulence, p. 254. (2) Bio-chemical reactions, p. 256. | |
| (3) Toxin—Preparation, p. 257; Testing and storing, p. 260; Action on animals, p. 260; Nature and properties, p. 261. (4) Vaccination, p. 262. (5) Serum therapy—Antitoxin, its preparation, p. 265; Properties, p. 266; Standardization, p. 267; Serum therapeutics, p. 268. (6) Agglutination, p. 269. | |
| <i>Section IV. The detection, isolation and identification of the diphtheria bacillus,</i> | 269 |
| (1) The collection of material, p. 270. (2) Methods of examination, p. 270. (3) Summary of diagnostic tests, p. 273. | |
| Bacillus pseudo-diphtheriæ (Hofmann's bacillus), | 273 |
| XVI. Bacillus pyocyaneus. | |
| <i>Introduction,</i> | 276 |
| <i>Section I. Experimental inoculation,</i> | 276 |
| <i>Section II. Morphology,</i> | 277 |
| <i>Section III. Biological properties,</i> | 279 |
| <i>Section IV. Detection and isolation of the organism,</i> | 281 |
| XVII. The bacillus of swine erysipelas. | |
| <i>Introduction,</i> | 283 |
| <i>Section I. Experimental inoculation,</i> | 284 |
| <i>Section II. Morphology,</i> | 284 |
| <i>Section III. Biological properties,</i> | 286 |
| <i>Section IV. The detection, isolation and identification of the bacillus,</i> | 287 |
| The bacillus of mouse septicæmia, p. 288. | |
| SUB-DIVISION II. THE NON-SPORE-BEARING, GRAM-POSITIVE, ACID-FAST BACILLI. | |
| XVIII. Bacillus tuberculosis. | |
| <i>Introduction,</i> | 289 |
| (1) Types of tubercle bacilli, p. 289. (2) Human tuberculosis, p. 292. (3) Tuberculosis in the lower animals, p. 294. (4) Associated micro-organisms, p. 297. | |
| <i>Section I. Experimental inoculation,</i> | 297 |
| A. Guinea-pigs, p. 297. B. Rabbits, p. 300. C. Dogs, p. 302. D. Cattle, p. 303. E. Birds, p. 304. F. Cold-blooded vertebrata, p. 305. | |
| <i>Section II. Morphology,</i> | 305 |
| (1) Microscopical appearance, p. 305; Staining methods, p. 306. A. The staining of films, p. 307. B. The staining of sections, p. 310; The appearance of stained bacilli, p. 312. (2) Cultural characteristics, p. 314. | |

| | |
|---|-----|
| <i>Section III. Biological properties,</i> | 322 |
| (1) Viability and virulence, p. 322. (2) Toxins, p. 323. A. Toxic properties of dead bacilli, p. 323. B. Koch's old tuberculin, p. 324. C. Tuberculins T.A., T.O., T.R., p. 328. D. Maragliano's tuberculin, p. 329. E. Toxalbumin, p. 329. (3) Vaccination, p. 330. (4) Serum therapy, p. 334. (5) Agglutination, p. 335. (6) Immune body, p. 337. | |
| <i>Section IV. The detection of the tubercle bacillus,</i> | 337 |
| A. Sputum, p. 339. B. Blood, p. 341. C. Pus, p. 342. D. Exudates, p. 342. E. Granulomata, p. 343. F. Nasal cavities, p. 343. G. Urine, p. 343. H. Excreta, p. 344. I. Milk, p. 345. | |
| The paratubercle or acid-fast bacilli, | 345 |
| XIX. Bacillus lepræ. | |
| <i>Introduction,</i> | 348 |
| <i>Section I. Attempts to reproduce the disease experimentally,</i> | 348 |
| <i>Section II. Morphology,</i> | 350 |
| <i>Section III. Serum therapy,</i> | 353 |
| <i>Section IV. Detection and identification of the leprosy bacillus,</i> | 354 |
| SUB-DIVISION III. THE NON-SPORE-BEARING, GRAM-NEGATIVE BACILLI THAT DO NOT LIQUEFY GELATIN. | |
| XX. Bacillus dysentericæ epidemicæ. | |
| <i>Introduction,</i> | 356 |
| <i>Section I. Experimental inoculation,</i> | 357 |
| <i>Section II. Morphology,</i> | 358 |
| <i>Section III. Biological properties,</i> | 359 |
| (1) Biochemical reactions, p. 359. (2) Vitality, p. 360. (3) Toxin, p. 361. (4) Vaccination and serum therapy, p. 361. (5) Agglutination, p. 363. (6) Precipitins, p. 363. (7) Immune body, p. 363. | |
| <i>Section IV. Detection, isolation and identification of the dysentery bacillus,</i> | 364 |
| Serum diagnosis of dysentery, p. 364. | |
| The bacillus dysentericus, El. Tor No. 1, | 365 |
| XXI. Bacillus febris entericæ. | |
| <i>Introduction,</i> | 366 |
| <i>Section I. Experimental inoculation,</i> | 367 |
| A. Inoculation of viruses of ordinary virulence, p. 368. B. Inoculation of viruses of exalted virulence, p. 368. C. Infection by the alimentary canal, p. 369. | |
| <i>Section II. Morphology,</i> | 370 |
| <i>Section III. Biological properties,</i> | 373 |
| (1) Biochemical reactions, p. 373. (2) Variability of flagella, p. 376. (3) Viability and virulence, p. 376. (4) Toxins, p. 376. (5) Vaccina- | |

tion, p. 380. (6) Serum therapy, p. 383. (7) Agglutination—Serum-diagnosis of enteric fever, p. 384. Application of agglutination reaction to the identification of the typhoid bacillus, p. 389. (8) Absorption of agglutinins, p. 389. (9) Complement fixation, p. 390.

Section IV. Detection, isolation and identification of the typhoid bacillus, - - - - - 390

XXII. Bacillus coli.

Introduction, - - - - - 393

Section I. Experimental inoculation, - - - - - 394

Section II. Morphology, - - - - - 395

Section III. Biological properties, - - - - - 396

(1) Biochemical reactions, p. 396. (2) Variability of flagella, p. 398. (3) Vitality and virulence, p. 398. (4) Toxin, p. 398. (5) Vaccination and serum therapy, p. 399. (6) Agglutination, p. 399.

Section IV. Detection, isolation and identification of the colon bacillus, - - - - - 400

The bacillus of green diarrhoea, - - - - - 400

XXIII. The isolation of the typhoid and colon bacilli from water, stools, etc., and the methods of identifying the two organisms.

Introduction, - - - - - 401

Section I. The isolation of the typhoid and colon bacilli, - 402

(1) Original methods, p. 402. (2) Elsner's method and its modifications, p. 403. (3) Precipitation methods, p. 406. (4) Methods based upon the motility of the typhoid bacillus, p. 406. (5) Chantemesse's carbolic media, p. 407. (6) Conradi-Drigalski's method, p. 407. (7) Endo's medium, p. 408. (8) Caffeine media, p. 408. (9) Malachite green media, p. 409. (10) China green medium, p. 410. (11) Bile media, p. 410. (12) Brilliant green medium, p. 411. (13) Neutral red media, p. 411. (14) Methods based upon agglutination, p. 412. MacConkey's media, p. 412.

Section II. The identification of the typhoid and colon bacilli, - 412

XXIV. The pneumobacillus of Friedländer.

Introduction, - - - - - 415

Section I. Experimental inoculation, - - - - - 416

Section II. Morphology, - - - - - 416

Section III. Biological properties, - - - - - 417

Section IV. Detection, isolation and identification of the pneumobacillus, - - - - - 418

The bacillus of rhinoscleroma, - - - - - 418

The bacillus of ozæna, - - - - - 419

XXV. The paratyphoid bacilli.

The origin of the terms "paratyphoid" and "paracolon."—The relation of the "paratyphoid" bacilli to the "hæmorrhagic septicæmia" group and to the "enteritidis" group.—The classification adopted.—The origin and definition of the "Salmonella group."—Other names suggested for the "paratyphoid" group, - - - 420

XXVI. Bacillus paratyphosus A.

| | |
|--|-----|
| <i>Introduction</i> , - - - - - | 423 |
| <i>Section I. Experimental inoculation</i> , - - - - - | 424 |
| <i>Section II. Morphology</i> , - - - - - | 424 |
| <i>Section III. Biological properties</i> , - - - - - | 424 |
| (1) Biochemical reactions, p. 424. (2) Vitality and virulence, p. 425. (3) Toxin, p. 425. (4) Vaccination, p. 425. (5) Agglutination, p. 426. (6) Absorption tests, p. 427. (7) Complement fixation, p. 428. | |
| <i>Section IV. The diagnosis of paratyphoid A infections. The isolation and identification of the bacillus</i> , - - - | 428 |

XXVII. The Salmonella group.**1. Bacillus paratyphosus B.**

| | |
|---|-----|
| <i>Introduction</i> , - - - - - | 431 |
| <i>Section I. Experimental inoculation</i> , - - - - - | 433 |
| <i>Section II. Morphology</i> , - - - - - | 433 |
| <i>Section III. Biological properties</i> , - - - - - | 434 |
| (1) Biochemical reactions, p. 434. (2) Toxins, p. 434. (3) Vaccination and the properties of immune serums, p. 435. (4) Agglutination, p. 435. (5) Absorption tests, p. 436. (6) Complement fixation, p. 437. | |
| <i>Section IV. The isolation and identification of the bacillus</i> , - | 437 |

2. Bacillus enteritidis Aertrycke.

| | |
|---|-----|
| <i>Introduction</i> , - - - - - | 438 |
| <i>Section I. Experimental infection</i> , - - - - - | 439 |
| <i>Section II. Morphology</i> , - - - - - | 440 |
| <i>Section III. Biological properties</i> , - - - - - | 440 |
| <i>Section IV. Isolation and identification of the bacillus</i> , - | 441 |

3. Bacillus enteritidis Gaertner.

| | |
|---|-----|
| <i>Introduction</i> , - - - - - | 442 |
| <i>Section I. Experimental inoculation</i> , - - - - - | 442 |
| <i>Section II. Morphology</i> , - - - - - | 443 |
| <i>Section III. Biological properties</i> , - - - - - | 443 |
| <i>Section IV. Isolation and identification of the bacillus</i> , - | 444 |

4. Pseudo-Gaertner bacilli, - - - - - 444

| | |
|--|-----|
| 5. <i>Bacillus typhi murium</i> , - - - - - | 444 |
| 6. Danysz's virus, - - - - - | 444 |
| 7. The bacillus of psittacosis, - - - - - | 445 |
| 8. <i>Bacillus icteroides</i> , - - - - - | 445 |
| XXVIII. The pasteurella group of bacilli. | |
| <i>Introduction</i> , - - - - - | 446 |
| I. <i>Pasteurella gallinæ</i> , - - - - - | 447 |
| <i>Section I. Experimental inoculation</i> , - - - - - | 448 |
| <i>Section II. Morphology</i> , - - - - - | 449 |
| <i>Section III. Biological properties</i> , - - - - - | 451 |
| <i>Section IV. The isolation and identification of the bacillus</i> , - | 452 |
| Similar organisms in epizootics among other birds, p. 452. | |
| II. <i>Pasteurella cuniculi</i> , - - - - - | 453 |
| III. <i>Pasteurella suis</i> , - - - - - | 454 |
| IV. <i>Pasteurella bovis</i> , - - - - - | 455 |
| V. <i>Pasteurella ovis</i> , - - - - - | 456 |
| VI. <i>Pasteurella capræ</i> , - - - - - | 456 |
| VII. <i>Pasteurella equi</i> , - - - - - | 456 |
| VIII. <i>Pasteurella canis</i> , - - - - - | 457 |
| M'Gowan's bacillus of distemper, p. 459. | |
| IX. Immunization with polyvalent vaccines, - - - - - | 459 |
| XXIX. Bacillus pestis. | |
| <i>Introduction</i> , - - - - - | 460 |
| <i>Section I. The experimental disease</i> , - - - - - | 463 |
| <i>Section II. Morphology</i> , - - - - - | 464 |
| <i>Section III. Biological properties</i> , - - - - - | 466 |
| (1) Vitality and virulence, p. 466. (2) Biochemical reactions, p. 467. | |
| (3) Toxin, p. 467. (4) Vaccination, p. 468. (5) Serum therapy, | |
| p. 471. (6) Agglutination, p. 472. (7) Precipitins, p. 473. | |
| <i>Section IV. Isolation and identification of the plague bacillus</i> , - - - - - | 473 |
| Post mortem appearances in naturally infected rats, p. 474. | |
| XXX. Micrococcus melitensis. | |
| <i>Introduction</i> , - - - - - | 475 |
| <i>Section I. Experimental inoculation</i> , - - - - - | 476 |
| <i>Section II. Morphology</i> , - - - - - | 476 |
| <i>Section III. Biological properties</i> , - - - - - | 477 |
| <i>Section IV. Detection, isolation and identification of the organism</i> , - - - - - | 478 |

XXXI. Bacillus mallei.

| | | |
|---|-----------|-----|
| <i>Introduction,</i> | - - - - - | 480 |
| <i>Section I. Experimental inoculation,</i> | - - - - - | 480 |
| <i>Section II. Morphology,</i> | - - - - - | 482 |
| <i>Section III. Biological properties,</i> | - - - - - | 484 |
| <i>Section IV. Detection and isolation of the bacillus,</i> | - - - - - | 486 |
| The diagnosis of glanders, p. 486. | | |

SUB-DIVISION IV. NON-SPORE-BEARING, GRAM-NEGATIVE BACILLI
THAT LIQUEFY GELATIN.

XXXII. Vibrio cholerae asiaticae.

| | | |
|--|-----------|-----|
| <i>Introduction,</i> | - - - - - | 488 |
| <i>Section I. The experimental disease,</i> | - - - - - | 489 |
| <i>Section II. Morphology,</i> | - - - - - | 491 |
| <i>Section III. Biological properties,</i> | - - - - - | 493 |
| (1) Vitality and virulence, p. 493. (2) Biochemical reactions, p. 494. | | |
| (3) Toxin, p. 494. (4) Vaccination, p. 496. (5) Serum therapy, p. 498. (6) Bactericidal properties—Agglutination, p. 499. (7) Complement fixation, p. 500. | | |
| <i>Section IV. Detection, isolation and identification of the vibrio,</i> | - - - - - | 500 |
| The vibrio of Finkler-Prior, | - - - - - | 502 |
| The vibrio of Deneke, | - - - - - | 503 |
| Vibrio metchnikowi, | - - - - - | 503 |

SUB-DIVISION V. NON-SPORE-BEARING, GRAM-NEGATIVE BACILLI
THAT DO NOT GROW ON GELATIN.

XXXIII. Pfeiffer's influenza bacillus.

| | | |
|---|-----------|-----|
| <i>Introduction,</i> | - - - - - | 504 |
| <i>Section I. Experimental inoculation,</i> | - - - - - | 505 |
| <i>Section II. Morphology,</i> | - - - - - | 506 |
| <i>Section III. Biological properties,</i> | - - - - - | 508 |
| <i>Section IV. Detection and isolation of the organism,</i> | - - - - - | 510 |
| The hæmoglobinophilic bacilli. | - - - - - | 510 |
| The bacillus of whooping cough (Bordet-Gengou). | - - - - - | 511 |

XXXIV. The bacillus of soft sore.

| | | |
|---|-----------|-----|
| <i>Introduction,</i> | - - - - - | 513 |
| <i>Section I. Experimental infection,</i> | - - - - - | 513 |
| <i>Section II. Morphology,</i> | - - - - - | 514 |
| <i>Section III. Biological properties,</i> | - - - - - | 515 |
| <i>Section IV. Detection, isolation and identification of the bacillus,</i> | - - - - - | 515 |

SUB-DIVISION VI. THE SPORE-BEARING, GRAM-POSITIVE,
AËROBIC BACILLI.

XXXV. Bacillus anthracis.

| | |
|---|-----|
| <i>Introduction</i> , - - - - - | 517 |
| <i>Section I. The experimental disease</i> , - - - - - | 518 |
| (1) Susceptible and immune animals, p. 518. (2) Methods of inoculation, p. 519. (3) Symptoms and lesions in experimental animals, p. 519. | |
| <i>Section II. Morphology</i> , - - - - - | 520 |
| (1) Microscopical appearance and staining reactions, p. 520. (2) Cultural characteristics, p. 524. | |
| <i>Section III. Biological properties</i> , - - - - - | 525 |
| (1) Viability and resistance, p. 525. (2) Virulence, p. 527. (3) Toxin, p. 529. (4) Serum therapy, p. 530. (5) Agglutination, p. 533. | |
| <i>Section IV. Detection, isolation and identification of the anthrax bacillus</i> , - - - - - | 533 |
| Examination of carcasses dead of anthrax, p. 534. Isolation of the bacillus from soil, 535. | |

SUB-DIVISION VII. THE SPORE-BEARING, GRAM-POSITIVE,
ANAËROBIC BACILLI.

XXXVI. Bacillus tetani.

| | |
|---|-----|
| <i>Introduction</i> , - - - - - | 536 |
| <i>Section I. Experimental inoculation</i> , - - - - - | 536 |
| (1) Inoculation of soil or pus, p. 537. (2) Inoculation of pure cultures, p. 537. (3) Inoculation of spores, p. 538. | |
| <i>Section II. Morphology</i> , - - - - - | 539 |
| <i>Section III. Biological properties</i> , - - - - - | 541 |
| (1) Vitality and virulence, p. 541. (2) Toxin, p. 541. (3) Vaccination, p. 544. (4) Serum therapy, p. 545. (5) Agglutination, p. 548. | |
| <i>Section IV. Detection, isolation and identification of the tetanus bacillus</i> , - - - - - | 548 |
| <i>Bacillus botulinus</i> , p. 549. | |

XXXVII. The bacillus of quarter ill.

| | |
|---|-----|
| <i>Introduction</i> , - - - - - | 552 |
| <i>Section I. The experimental disease</i> , - - - - - | 552 |
| <i>Section II. Morphology</i> , - - - - - | 554 |
| <i>Section III. Biological properties</i> , - - - - - | 556 |
| (1) Vitality and virulence, p. 556. (2) Vaccination, p. 556. (3) Toxin, p. 558. (4) Serum therapy, p. 559. (5) Agglutination, p. 560. | |

XXXVIII. Bacillus maligni œdematis.

| | |
|---|-----|
| <i>Introduction,</i> - - - - - | 561 |
| <i>Section I. The experimental disease,</i> - - - - - | 561 |
| <i>Section II. Morphology,</i> - - - - - | 563 |
| <i>Section III. Biological properties,</i> - - - - - | 565 |

SUB-DIVISION VIII.

XXXIX. Certain anaërobic micro-organisms found in gangrenous suppurations.

| | |
|--|-----|
| I. Bacillus perfringens, - - - - - | 569 |
| <i>The bacillus of Ghon and Sachs, p. 571.</i> | |
| II. Bacillus pseudo-œdema, - - - - - | 571 |
| III. Bacillus ramosus, - - - - - | 571 |
| IV. Bacillus serpens, - - - - - | 572 |
| V. Bacillus thetoides, - - - - - | 572 |
| VI. Bacillus fragilis, - - - - - | 573 |
| VII. Bacillus fusiformis, - - - - - | 574 |
| VIII. Spirillum nigrum, - - - - - | 577 |
| IX. Staphylococcus parvulus, - - - - - | 578 |
| X. Micrococcus fetidus, - - - - - | 578 |
| XI. Bacillus aërobicus sepis, - - - - - | 578 |

SUB-DIVISION IX. THE GRAM-POSITIVE MICROCOCCI.

XL. The pneumococcus.

| | |
|--|-----|
| <i>Introduction,</i> - - - - - | 580 |
| <i>Section I. Experimental inoculation,</i> - - - - - | 581 |
| <i>Section II. Morphology,</i> - - - - - | 582 |
| <i>Section III. Biological properties,</i> - - - - - | 585 |
| (1) Vitality and virulence, p. 585. (2) Biochemical reactions, p. 586. | |
| (3) Toxins, p. 586. (4) Vaccination, p. 587. (5) Serum therapy, p. 588. (6) Agglutination, p. 589. (7) Precipitins, p. 590. (8) Immune bodies, p. 590. | |
| <i>Section IV. Detection, isolation and identification of the pneumococcus,</i> - - - - - | 590 |

XLI. Streptococci hominis.

| | |
|---|-----|
| <i>Introduction,</i> - - - - - | 592 |
| <i>Varieties of streptococci, p. 593.</i> | |
| <i>Section I. Experimental inoculation,</i> - - - - - | 594 |
| <i>Section II. Morphology,</i> - - - - - | 595 |

Section III. Biological properties, - - - - - 599
 (1) Vitality and virulence p. 599. (2) Biochemical reactions, p. 600 ;
 Andrewes and Horder's classification, p. 601. (3) Toxins, p. 602 ;
 Streptocolysin, p. 603. (4) Vaccination, p. 604. (5) Serum therapy,
 p. 605 ; Monovalent serums, p. 606 ; Polyvalent serums, p. 608. (6)
 Agglutination, p. 609. (7) Bordet-Gengou reaction, p. 609.

Section IV. Detection and isolation of streptococci, - - - - - 609
 The streptococcus of Bonome, - - - - - 610

XLII. Streptococci animalium.

I. The streptococcus of strangles, - - - - - 611
 II. The streptococcus of contagious mammitis of cows, - - - - - 613
 III. The micrococcus of contagious mammitis of ewes,¹ - - - - - 615

XLIII. Staphylococci pyogenetes.

Introduction, - - - - - 617
Section I. Experimental inoculation, - - - - - 618
Section II. Morphology, - - - - - 619
Section III. Biological properties, - - - - - 620
 (1) Viability and virulence, p. 620. (2) Bio-chemical reactions,
 p. 621. (3) Toxin, p. 622. (4) Vaccination, p. 623. (5) Serum
 therapy, p. 624. (6) Agglutination, p. 624.
Section IV. Detection, isolation and identification of the
staphylococci. - - - - - 625
 The diplococcus crassus, - - - - - 626

XLIV. The enterococcus.

Introduction, - - - - - 627
Section I. Experimental inoculation, - - - - - 627
Section II. Morphology and biological properties, - - - - - 628
 (1) Microscopical appearance, p. 628. (2) Cultural characteristics,
 p. 628. (3) Vitality and virulence, p. 629.
Section III. The detection, isolation and identification of the
enterococcus, - - - - - 629

XLV. Micrococcus tetragenus.

Introduction, - - - - - 631
Section I. Experimental inoculation, - - - - - 631
Section II. Morphology, - - - - - 632
Section III. Biological properties, - - - - - 632
Section IV. Detection, isolation and identification of the
organism, - - - - - 633

¹ Though morphologically not belonging to the group it will be convenient to include the micrococcus in the same chapter as the streptococcus causing mammitis in cows

SUB-DIVISION X. THE GRAM-NEGATIVE MICROCOCCI.

XLVI. The gonococcus.

| | |
|---|-----|
| <i>Introduction</i> , - - - - - | 634 |
| <i>Section I. Experimental inoculation</i> , - - - - - | 635 |
| <i>Section II. Morphology</i> , - - - - - | 635 |
| (1) Microscopical appearance and staining reactions, p. 635. (2) Cultural characteristics, p. 638. | |
| <i>Section III. Biological properties</i> , - - - - - | 640 |
| <i>Section IV. Detection and isolation of the gonococcus</i> , - - | 642 |

XLVII. The meningococcus.

| | |
|--|-----|
| <i>Introduction</i> , - - - - - | 644 |
| Relationship of the meningococcus to the gonococcus. | |
| <i>Section I. Experimental inoculation</i> , - - - - - | 645 |
| <i>Section II. Morphology</i> , - - - - - | 645 |
| <i>Section III. Biological properties</i> , - - - - - | 647 |
| <i>Section IV. The isolation and identification of the meningococcus</i> , - - - - - | 650 |
| Micrococcus catarrhalis , - - - - - | 651 |

PART III. THE PARASITIC FUNGI.**XLVIII. The parasitic Hypomycetes.**

| | |
|---|-----|
| <i>Section I. The genus Discomyces</i> , - - - - - | 655 |
| Introduction. | |
| I. Discomyces bovis , - - - - - | 656 |
| (1) Experimental inoculation, p. 656. (2) Morphology; Detection of the parasite. A. Microscopical appearance, p. 657. B. Cultural characteristics, p. 659. (3) Biological properties, p. 660. <i>The parasites of actinomycosis</i> , p. 660. | |
| II. Discomyces israeli , p. 661. III. Discomyces thibiergi , p. 661. | |
| IV. Discomyces liquefaciens , p. 661. V. Discomyces garteni , p. 661. VI. Discomyces asteroides , p. 662. VII. Discomyces forsteri , p. 662. VIII. Discomyces rosenbachi , p. 662. IX. Discomyces maduræ , p. 662. X. Discomyces freeri , p. 664. XI. Discomyces brasiliensis , p. 665. <i>The parasites of mycetoma</i> , p. 665. | |
| XII. Discomyces minutissimus , p. 666. XIII. Discomyces farcinicus , p. 667. XIV. Discomyces capræ , p. 668. XV. Discomyces hofmanni , p. 669. XVI. The polychrome discomyces of Vallée , p. 669. | |

| | | |
|--|-----------|-----|
| <i>Section II. The genus Malassezia,</i> | - - - - - | 669 |
| <i>Section III. The genus Trichosporum,</i> | - - - - - | 670 |
| <i>Section IV. The genus Coccidioides,</i> | - - - - - | 671 |
| <i>Section V. The genus Sporotrichum,</i> | - - - - - | 672 |
| <i>Section VI. The genus Oidium,</i> | - - - - - | 674 |
| <i>Section VII. Of unknown classification.</i> | - - - - - | 674 |
| The parasite of Bursattee. | | |

XLIX. The parasitic Phycomycetes. Parasites of the family Mucoracidæ.

| | | |
|---|-----------|-----|
| <i>Introduction,</i> | - - - - - | 675 |
| General methods of examination, cultivation, etc. | | |
| <i>Section I. The genus Mucor,</i> | - - - - - | 676 |
| <i>Section II. The genus Lichtheimia,</i> | - - - - - | 677 |
| <i>Section III. The genus Rhizomucor,</i> | - - - - - | 678 |
| <i>Section IV. The genus Rhizopus,</i> | - - - - - | 678 |

L. The parasitic Ascomycetes. Parasites of the family Gymnoascidæ.

| | | |
|--|-----------|-----|
| <i>Section I. The genus Trichophyton,</i> | - - - - - | 679 |
| General methods of examination, cultivation, etc. | | |
| A. Endothrix species, | - - - - - | 682 |
| (1) <i>Trichophyton tonsurans</i> , p. 682. (2) <i>Trichophyton sabouraudi</i> , p. 684. (3) <i>Trichophyton violaceum</i> , p. 685. (4) <i>Trichophyton sulphureum</i> , p. 685. | | |
| B. Endo-ectothrix species, | - - - - - | 685 |
| (1) <i>Trichophyton mentagrophytes</i> , p. 685. (2) <i>Trichophyton equinum</i> , p. 687. (3) <i>Trichophyton caninum</i> , p. 687. (4) <i>Trichophyton felineum</i> , p. 687. (5) <i>Trichophyton megnini</i> , p. 687. (6) <i>Trichophyton faviforme</i> , p. 687. (7) <i>Trichophyton concentricum</i> , p. 687. | | |
| <i>Section II. The genus epidermophyton,</i> | - - - - - | 688 |
| <i>Epidermophyton cruris</i> , p. 688. | | |
| <i>Section III. The genus Microsporum,</i> | - - - - - | 688 |
| (1) <i>Microsporum audouini</i> , p. 688. | | |
| <i>Section IV. The genus Achorion,</i> | - - - - - | 690 |
| A. The human parasite—Achorion schœnleini, | - - - - - | 690 |
| B. The parasites of favus in the lower animals, | - - - - - | 692 |
| <i>Section V. The genus Lophophyton,</i> | - - - - - | 692 |
| <i>Lophophyton gallinæ</i> , p. 692. | | |
| <i>Section VI. Micro-organisms in Alopecia areata,</i> | - - - - - | 692 |
| <i>Section VII. The bacillus of seborrhœa oleosa,</i> | - - - - - | 692 |

LI. The parasitic Ascomycetes (continued). Parasites of the family Perisporaciadæ.

| | |
|---|-----|
| <i>Introduction</i> , - - - - - | 694 |
| General methods of examination, cultivation, etc. | |
| <i>Section I. The genus Aspergillus</i> , - - - - - | 695 |
| (1) <i>Aspergillus glaucus</i> , p. 695. (2) <i>Aspergillus repens</i> , p. 695. (3) <i>Aspergillus malignus</i> , p. 695. (4) <i>Aspergillus fumigatus</i> , p. 695. (5) <i>Aspergillus pictor</i> , p. 698. | |
| <i>Section II. The genus Sterygmatozystis</i> , - - - - - | 699 |
| <i>Section III. The genus Penicillum</i> , - - - - - | 700 |
| <i>Section IV. The parasite of Tinea imbricata</i> , - - - - - | 700 |

LII. The parasitic Ascomycetes (continued). Parasites of the family Saccharomycetidæ.

| | |
|--|-----|
| <i>Introduction</i> , - - - - - | 701 |
| <i>Section I. The genus Endomyces,—Endomyces albicans</i> , | 701 |
| <i>Section II. The genus Saccharomyces</i> , - - - - - | 704 |
| (1) <i>Saccharomyces tumefaciens</i> , p. 704. (2) Other species of <i>Saccharomyces</i> , p. 705. | |
| <i>Section III. The genus Cryptococcus</i> , - - - - - | 706 |
| <i>Section IV. The Saccharomyces and Cancer</i> , - - - - - | 707 |

PART IV. THE PATHOGENIC SPIROCHÆTÆ.

LIII. The blood-inhabiting spirochætæ.

A. Human spirochætosis.

| | |
|--|-----|
| <i>Introduction</i> , - - - - - | 711 |
| <i>Section I. Experimental inoculation</i> , - - - - - | 713 |
| <i>Section II. Morphology and methods of detection</i> , | 714 |
| (1) Microscopical appearance and staining reactions, p. 714. (2) Cultivation of the parasites, p. 715. | |
| <i>Section III. Serum therapy</i> , - - - - - | 716 |
| The differentiation of the various human spirochætæ, p. 717. | |

B. Spirochætosis in the lower animals, - - - - - 717

- (1) *Spirochæta anserina*, p. 717. (2) *Spirochæta marchouxi*, p. 718. (3) *Spirochæta theileri*, p. 719.

LIV. The treponema pallidum.

| | |
|--|-----|
| <i>Introduction</i> , - - - - - | 720 |
| <i>Section I. Experimental inoculation</i> , - - - - - | 721 |
| Experiments on immunization, p. 724. | |
| <i>Section II. Morphology</i> , - - - - - | 725 |
| (1) Microscopical appearance, p. 725. (2) Staining methods, p. 726. a. Films, p. 727. β . Flagellum staining, p. 730. γ . Sections, p. 730. | |

| | | |
|---|-----------|-----|
| <i>Section III. Detection and identification of the treponema,</i> | - | 732 |
| <i>Section IV. Cultivation experiments,</i> | - - - - - | 736 |
| <i>Section V. Serum diagnosis,</i> | - - - - - | 737 |
| Wassermann's reaction, p. 737. Chemical methods of serum diagnosis, p. 740. | | |

PART V. THE PROTOZOAN PARASITES.

I. THE RHIZOPODA.

LV. The amœbæ.

| | | |
|--|-----------|-----|
| <i>Introduction,</i> | - - - - - | 745 |
| <i>Section I. Amœba princeps,</i> | - - - - - | 745 |
| <i>Section II. The intestinal amœbæ,</i> | - - - - - | 746 |
| (i) <i>Amœba coli</i> , p. 747. (ii) <i>Amœba histolytica</i> , p. 748. | | |
| Methods of detection, p. 748. Cultivation, p. 750. Experimental infection, p. 751. | | |

II. THE SPOROZOA.

A. THE NEOSPORIDIA.

LVI. The Microsporidia, Myxosporidia, Sarcosporidia, Haplosporidia.

| | | |
|---|-----------|-----|
| <i>Section I. The Microsporidia,</i> | - - - - - | 752 |
| <i>Nosema bombycis</i> , 752. <i>Nosema apis</i> , 753. | | |
| <i>Section II. The Myxosporidia,</i> | - - - - - | 754 |
| <i>Section III. The Sarcosporidia,</i> | - - - - - | 756 |
| <i>Section IV. The Haplosporidia,</i> | - - - - - | 759 |

B. THE TELOSPORIDIA.

LVII. The Coccidiidea.

| | | |
|---|-----------|-----|
| <i>Section I. The genus Coccidium,</i> | - - - - - | 760 |
| <i>Coccidium cuniculi</i> , p. 760. Morphology, p. 761. Life history, p. 762. | | |
| Other principal species of coccidia, p. 764. | | |
| <i>Section II. The genus Klossia,</i> | - - - - - | 765 |
| <i>Section III. Parasites in tumours,</i> | - - - - - | 766 |
| (1) <i>Coccidia</i> p. 766. (2) <i>Micrococcus neoformans</i> , p. 769. | | |

LVIII. The intra-corpuseular Hæmatozoa.

| | | |
|---------------------------------------|-----------|-----|
| <i>Section I. The genus hæmamœba,</i> | - - - - - | 770 |
|---------------------------------------|-----------|-----|

| | |
|---|-----|
| 1. The hæmatozoon of malaria, - - - - - | 770 |
| Methods of examination, p. 770. Structure of the parasite, p. 772. Morphology, p. 774. Life history, p. 776. The different species of hæmatozoa found in malaria, p. 778. | |
| Examination of mosquitos, p. 780. | |
| Experimental inoculation, p. 781. | |
| 2. The hæmatozoon of monkeys, - - - - - | 781 |
| 3. The hæmatozoon of bats, - - - - - | 781 |
| 4. The hæmatozoa of birds, - - - - - | 781 |
| <i>Section II. The genus Hæmogregarina,</i> - - - - - | 783 |
| 1. Hæmogregarina stepanowi, - - - - - | 783 |
| 2. Hæmogregarina ranarum, - - - - - | 784 |
| 3. Hæmogregarina lacertarum, - - - - - | 785 |
| LIX. The intra-corpuseular hæmatozoa (continued). | |
| <i>Section III. The genus Piroplasma,</i> - - - - - | 786 |
| 1. Piroplasma bigeminum, - - - - - | 787 |
| Morphology and method of multiplication, p. 787. Methods of examination, p. 790. Immunity, p. 791. | |
| 2. Piroplasma ovis, - - - - - | 791 |
| 3. Piroplasma canis, - - - - - | 791 |
| 4. Piroplasma equi, - - - - - | 792 |
| 5. Piroplasma pitheci, - - - - - | 793 |
| <i>Section IV. The genus Theileria,</i> - - - - - | 793 |
| <i>Theileria parva.</i> | |
| LX. The Gregarinida. - - - - - | 794 |
| <i>C. OF UNCERTAIN CLASSIFICATION.</i> | |
| LXI. Parasites of the genus Leishmania. | |
| 1. Leishmania donovani, - - - - - | 797 |
| Methods of detection and appearance of the parasite in the tissues, p. 797. Appearance in cultures, p. 799. Ætiology, p. 799. Experimental inoculation, p. 800. | |
| 2. Leishmania infantum, - - - - - | 800 |
| 3. Leishmania tropica, - - - - - | 802 |
| III. THE FLAGELLATA. | |
| LXII. The Flagellata. | |
| <i>Introduction,</i> - - - - - | 803 |
| <i>Section I. The Trypanosomata,</i> - - - - - | 803 |
| Introduction and general methods of examination, p. 803. | |

| | |
|--|-----|
| 1. <i>Trypanosoma lewisi</i> . The rat trypanosome, - - - | 805 |
| Trypanosomes in rodents other than rats, p. 808. | |
| 2. <i>Trypanosoma equiperdum</i> . The trypanosome of Dourine, - | 809 |
| 3. <i>Trypanosoma brucei</i> . The trypanosome of Nagana, - - | 811 |
| African trypanosomiasis related to nagana, p. 813. | |
| 4. <i>Trypanosoma evansi</i> . The trypanosome of Surra, - - | 814 |
| 5. <i>Trypanosoma equinum</i> . The trypanosome of Mal de Caderas, - - - - - - - - - | 814 |
| 6. <i>Trypanosoma theileri</i> . The trypanosome of Galziette, - | 816 |
| 7. The trypanosomes of Sleeping Sickness, - - - - | 816 |
| Trypanosoma gambiense, p. 816. | |
| Trypanosoma rhodesiense, p. 820. | |
| 8. <i>Trypanosoma cruzi</i> , - - - - - - - - - | 822 |
| 9. Trypanosomes in birds, - - - - - - - - - | 823 |
| 10. Trypanosomes in cold-blooded vertebrata, - - - - | 824 |
| Section II. <i>Trichomonas vaginalis</i> , - - - - - | 825 |
| Other species of <i>Trichomonas</i> , p. 826. | |
| Section III. <i>Lambliia intestinalis</i> , - - - - - | 827 |

IV. THE INFUSORIA.

LXIII. The Infusoria.

| | |
|--|-----|
| Introduction and general methods of examination, p. 829. | |
| Parasitic species, - - - - - | 830 |

PART VI.

LXIV. The filtrable viruses.

| | |
|---|-----|
| Introduction, - - - - - | 835 |
| Section I. The virus of Pleuro-pneumonia in cattle, - - | 836 |
| (1) Experimental inoculation and vaccination, p. 836. (2) Methods of diagnosis and characteristics of the organism, p. 837. | |
| Section II. The virus of Foot and Mouth disease, - - | 838 |
| Section III. The virus of Horse-sickness, - - - - | 838 |
| Section IV. The virus of Rinderpest, - - - - - | 839 |
| Section V. The virus of Bird plague, - - - - - | 839 |
| Section VI. The virus of Sheep-pox, - - - - - | 839 |
| The "infectious epithelioses," p. 840. | |
| Section VII. The virus of Cow-pox, - - - - - | 840 |
| Section VIII. The virus of Yellow fever, - - - - - | 841 |
| Section IX. The virus of Rabies, - - - - - | 841 |

| | | |
|---|---------|-----|
| <i>Section X. Filtrable viruses in the Pasteurelloses.</i> | - - | 842 |
| <i>Section XI. The virus of Swine-fever,</i> | - - - - | 843 |
| <i>Section XII. The virus of Acute anterior polio-myelitis,</i> | - - | 844 |
| <i>Section XIII. The virus of Typhus fever,</i> | - - - - | 847 |

**PART VII. THE APPLICATION OF BACTERIOLOGICAL METHODS
TO THE EXAMINATION OF WATER, SEWAGE AND AIR.**

LXV. The bacteriological examination of water.

| | | |
|--|-----------|-----|
| <i>Introduction,</i> | - - - - - | 851 |
| <i>Section I. The collection and transmission of samples of water,</i> | - - - - - | 851 |
| <i>Section II. The methods of examination,</i> | - - - - - | 853 |
| (1) Enumeration of the organisms, p. 853. (2) Determination of the nature of the organisms present, p. 856. (3) Houston's method of water examination, p. 858. | | |
| The bacteriological examination of sewage, p. 861. | | |

LXVI. The bacteriological examination of air.

| | | |
|--|-----------|-----|
| <i>Introduction,</i> | - - - - - | 862 |
| 1. Original methods, p. 862. 2. Methods employed at the present day, p. 864. | | |
| Index, | - - - - - | 868 |

PART I.
GENERAL TECHNIQUE.

CHAPTER I.

STERILIZATION.

Introduction.

Section I—Sterilization by dry heat, p. 4.

1. Sterilization in a naked flame, p. 4.
2. Sterilization by hot air, p. 4.

Section II—Sterilization by moist heat, p. 7.

1. Sterilization in steam at 100° C., p. 7.
2. Sterilization in steam under pressure, p. 9.
3. Sterilization by discontinuous heating, p. 12.

Section III—Sterilization by filtration, p. 14.

1. The filtration of water, p. 15.
2. The filtration of culture media, p. 18 ;
(A) by compression, p. 18 ; (B) by aspiration, p. 19.
3. The filtration of small quantities of liquid, p. 24.

Section IV—Sterilization by antiseptics, p. 26.

FOR the study of any given micro-organism it is necessary to have a pure culture of the organism, that is to say a culture from which all other organisms have been excluded. Since micro-organisms are universally present in air and water and in the ambient media generally, it is essential that all vessels, culture media, instruments, etc., to be used in the preparation and investigation of pure cultures should themselves be free from living organisms, or in other words be sterile. **Sterilization** therefore means the destruction of living micro-organisms in, [or their removal from,] materials and apparatus used in bacteriological investigations.

It would however be useless to sterilize vessels, instruments and culture media unless steps were also taken to prevent them from again becoming soiled (using the word in its bacteriological sense) before being put to their proper use ; they must therefore be dealt with in such a manner that when sterilized they are completely protected from contact with extraneous organisms.

To accomplish this, vessels with a narrow mouth such as flasks, bottles and tubes are plugged with wool after being washed and before sterilization, such articles as watch-glasses, dishes, etc., are wrapped in paper, [while metal instruments, pipettes, etc., may be placed in a metal cylinder or box, or in a piece of glass tubing of large diameter plugged with wool at the two ends].

1. **Plugging with wool.**—To plug a narrow-mouthed vessel take a small piece of non-absorbent cotton-wool, fold it by twisting it round and round, insert one end into the mouth of the vessel and then force it gently to a depth of 2 to 3 cm. leaving the other end projecting from the orifice. It is better that the plug should be too large than too small.

2. **Paper covers.**—For wrapping up vessels and other articles ordinary filter paper may be used, but any common paper of decent texture is equally serviceable and has the merit of being more economical.

(a) Watch-glasses, Petri dishes, etc., should be wrapped in several folds of paper.

(b) Wide-mouthed cylindrical or conical vessels only need to have the opening covered with a double layer of paper, though this should be large enough to allow of it being turned down and twisted [or tied] round the vessel, so that the greater part of the latter is enveloped. In doing this, be careful not to tear the paper, which is apt to split on the edges of the opening.

[3. **Other methods.**—Petri dishes, pipettes, watch-glasses, metal instruments, etc., may be conveniently enclosed in copper boxes of suitable shape, which should have tightly fitting lids with a deep overlap. For ordinary Petri dishes a circular copper cylinder 25 × 12 cm. (fig. 1) containing a moveable tray may be used; for pipettes a similar but longer and narrower cylindrical metal vessel or rectangular box is useful. Pipettes may also



FIG. 1.—Copper cylinder with deep overlap in which to sterilize Petri dishes.

be enclosed in a piece of large glass tubing, which is then plugged at both ends with wool. The pipettes must of course be themselves plugged at the upper end with wool.]

Sterilization may be effected in one of several ways, the most generally employed being heat and filtration; chemical antiseptics are seldom used in bacteriology. The methods of sterilization commonly employed will now be considered in detail.

SECTION I.—STERILIZATION BY DRY HEAT.

1. Sterilization in a naked flame.

1. The simplest means of sterilizing a metal instrument is to **heat it to redness** in a spirit flame or Bunsen burner. This method is always adopted for sterilizing platinum wires and iron and nickel spatulas.

Knives and similar instruments can also of course be sterilized by heating them in a flame, but on account of the injury done to the instrument the method is very rarely adopted.

An instrument which has been sterilized by heating to redness must be cooled before it is allowed to touch any material which is to be used for sowing cultures.

2. An instrument may be sterilized by **flaming it**, *i.e.* by passing it rapidly through a hot flame.

Only pipettes, glass rods, and other instruments with polished surfaces devoid of crevices in which organisms might escape destruction can be sterilized in this way, so that the method is of limited application.

2. Sterilization by hot air.

Exposure to hot air is the usual method of sterilizing all glass and porcelain apparatus, instruments with metal handles, etc., but it is not suitable for organic substances, with the exception of wool and paper.

Some form of apparatus in which sterilization can be effected by means of hot air is to be found in all laboratories.

To ensure efficient sterilization, the temperature must be maintained at approximately 180° C. for 30 minutes. Cotton-wool and paper are slightly scorched and browned at this temperature.

Hot air sterilizers.

The various forms of hot air sterilizers differ from one another only in details and in external appearance, the principles of construction and methods of use being the same in all.

1. **Pasteur's sterilizer** (fig. 2) is a double-walled cylinder of sheet iron with a chimney outlet, and is fitted internally with a wire basket in which the articles to be sterilized are packed. The top is closed by a lid, through

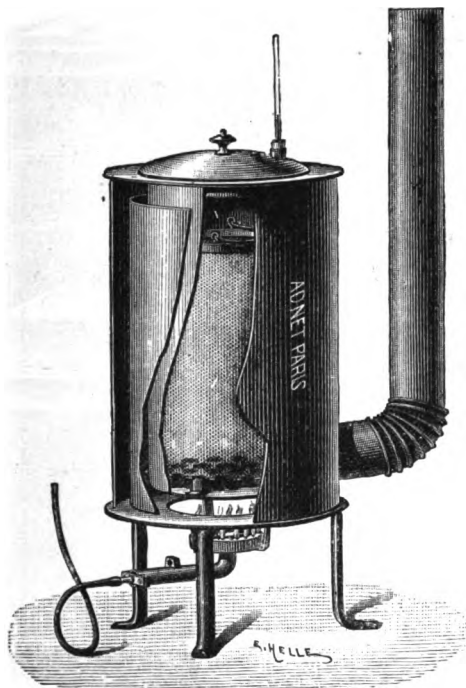

FIG. 2. — Pasteur's hot air sterilizer.

a hole in which a cork carrying a thermometer registering to 200° C. is passed. The heat is derived from a large gas burner below, and when this is lighted the heated air rising from the bottom of the stove circulates between the inner and outer walls and escapes up the chimney.

2. **Chantemesse's and Poupinel's hot air sterilizers** are rectangular and cupboard-shaped. They are fitted internally with moveable shelves on which the glass and other apparatus is arranged.

[3. **Hearson's hot air sterilizer** (fig. 3) is similar in shape to Chantemesse's, but is provided with an arrangement by which the gas is automatically regulated when the temperature has reached the point for which the regulator is set.]

Technique of sterilization by hot air.

(a) Carefully wash and rinse in a large volume of water all apparatus, whatever its nature, until all traces of organic matter have been removed. Unless the cleansing of glass for example be very thorough, black stains, due to the charring of organic matter during the heating process, will be found on the surface after sterilization. After washing allow the apparatus to dry, being specially careful in the case of glass, to avoid subsequent breakage during heating. When dry, treat each article in the manner already described, either plugging with wool, wrapping in paper, or packing in a metal box, according to its nature and use.

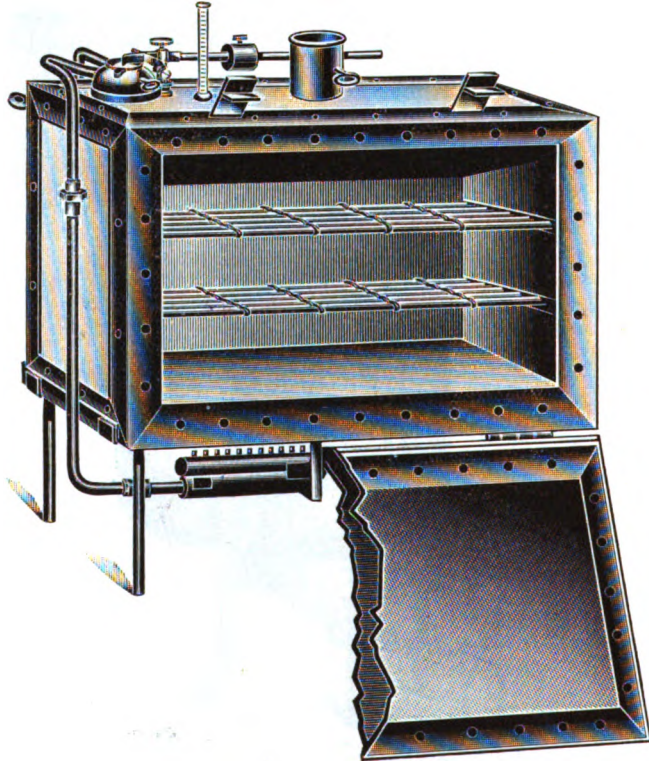

FIG. 3.—Hearson's hot air sterilizer.

(b) Place the articles in the sterilizer, taking care that neither wool nor paper touch the floor or sides, for these substances will char if they come in contact with the heated metal, and a tarry product rich in antiseptic substances will be deposited on the sterilized vessels, which will interfere with the subsequent growth of organisms. If by accident charring should take place, the articles which have been soiled must be washed, first in alcohol, then in water, dried and re-sterilized.

To avoid charring and breakage, it is advisable to place one or two fire bricks on the bottom of the sterilizer to keep the contents from touching the heated metal surface.

(c) Close the sterilizer and place the thermometer in position, pushing the latter well down into the interior.

(d) Light the gas. It is well to hold a lighted taper to the burner *before* turning on the tap, since if gas escape it will mix with the air between the inner and outer walls of the sterilizer and so tend to cause an explosion.

(e) Regulate the flame so that the temperature rises slowly; this is particularly important if the sterilizer contain vessels of thick glass, *e.g.* test-tubes on feet, glass dishes, etc.

(f) When the thermometer records a temperature of 175°–180° C. in the interior of the sterilizer, lower the gas gently, leaving sufficient flame to maintain the temperature at 180° C. or thereabouts for half an hour or so.

With a little practice this is easily done. Rather than use the fingers it is better to manipulate the tap by tapping it with some heavy instrument such as the spanner used for tightening the bolts of the autoclave, which will give very delicate control over the supply of gas, and will obviate the annoyance caused by accidentally turning out the gas altogether.

When experience has been gained, a thermometer can be dispensed with; at a temperature of 180° C. wool and paper become slightly scorched, and when this effect is noted the gas is turned down.

(g) When sterilization is completed turn out the gas, but allow the temperature to fall considerably before removing the contents, because glass, and especially thick glass, is liable to crack if exposed to a sudden change of temperature.

[With *Hearson's* hot air sterilizer the procedure is the same, except that stage (f) is omitted; when the temperature for which the capsule is set is reached, the gas is automatically lowered. It is only necessary therefore to note when the thermometer reaches the point at which sterilization is to be effected, and half an hour later to turn out the gas and proceed as in (g).]

SECTION II.—STERILIZATION BY MOIST HEAT.

Sterilization by moist heat may be effected in one of three ways.

1. By heating in water or steam at 100° C.
2. By heating in steam under pressure.
3. By discontinuous heating at low temperatures.

1. Sterilization in steam at 100° C.

Simple boiling or exposure to steam at 100° C., even though the exposure be prolonged, is not a reliable method of sterilization.

When micro-organisms have been dried, their resistance to the effects of heat is much enhanced, and especially is this the case when they are mixed with substances of an albuminoid nature. Further there are certain resistant forms of bacterial protoplasm known as spores, which in the majority of cases at least are not destroyed by heating to 100° C., even when the temperature is maintained for several minutes.

In France sterilization by moist heat at 100° C. is very seldom employed, except for sterilizing syringes for inoculation. In this case a sufficient degree of asepsis is obtained by boiling in water for 15 to 20 minutes at ordinary atmospheric pressure.

[In England on the other hand, and] in Germany, sterilization by moist heat at 100° C. is in general use. The operation is carried out in a Koch's sterilizer or steamer, and must be repeated at intervals of 24 hours on at least two, but ordinarily on three, successive days.

This method is the outcome of an observation by Tyndall to the effect that while it is impossible to sterilize an infusion of hay by boiling it continuously even for a prolonged period, yet by boiling it for a short time on three successive days all living organisms are destroyed.

This process embodies the principle of sterilization by discontinuous heating. The explanation put forward by Tyndall was that the hay infusion contains both bacilli and spores (*B. subtilis*). By heating to 100° C. the bacilli, but not the spores, are killed. The latter germinate as the fluid cools, and are killed during the second heating. A few spores however escape destruction on the second heating; these will have germinated by the time the third heating is due. After the third heating then sterilization is completed. The explanation now given however is that the resistance of micro-organisms is gradually lowered under the influence of repeated heating.

Steamers.

1. Koch's steamer.—Koch's steamer (fig. 4) consists of a cylindrical copper boiler, provided with a water gauge below and closed above by a lid through a hole in which a thermometer can be passed. It is fitted with perforated and moveable metal trays on which to rest the apparatus.

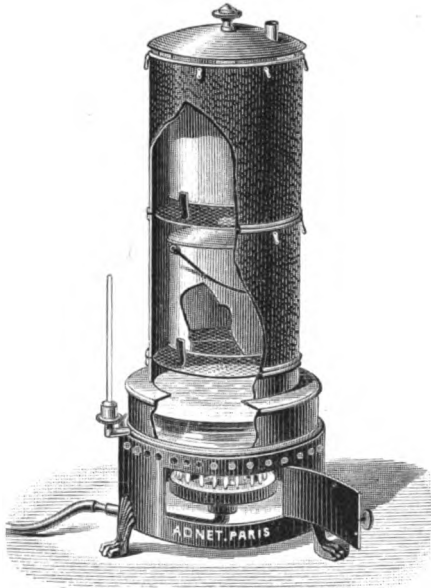

FIG. 4.—Koch's steamer.

A metal cylinder open at both ends is often supplied with the sterilizer, so that the latter can be lengthened when necessary by fitting the metal cylinder on top.

Technique.—When sterilizing culture media by steam at 100° C., it is advisable to use vessels already sterilized in the hot air sterilizer.

(a) Pour sufficient water into the steamer to reach the level marked on the water gauge. Stand the vessels on the trays, and if extra space be needed adjust the lengthening cylinder. Put on the lid, and insert the thermometer.

(b) Light the gas under the boiler, note when steam begins to escape from under the lid—the thermometer will then register 98°–100° C.—and maintain the apparatus at this temperature for 30 minutes.

(c) Heat again in a similar manner on the two following days.

When the flasks, tubes, etc., are taken out of the steamer, the wool plugs are generally wet with water of condensation; and since wool is only efficient as a filter for micro-organisms so long as it is absolutely free from moisture, the vessels may be put in the incubator for an hour or two to dry the plugs.

In many of the newer patterns of steamers the steam circulates between double walls before escaping, thus maintaining an absolutely constant temperature in the steamer. Some forms are further provided with a constant-level adjustment. [One of the most useful of these newer patterns is that made by Hearson.]

[2. Hearson's steamer.—Hearson's steamer (fig. 5) consists of two copper cylinders, one suspended within the other, thus conserving the heat. By means of a special regulator the gas is automatically lowered when the inner chamber is full of steam, and this, instead of escaping into the sterilizing

room, is condensed and returned to the boiler. A further advantage is that the water is added from the outside.]

2. Sterilization in steam under pressure.

Water, syringes, india-rubber apparatus, filters, etc., are generally sterilized by heating in steam under pressure. This method is also in general use for the sterilization of certain culture media, but is not particularly suitable for steel cutting instruments, as it destroys the edge.

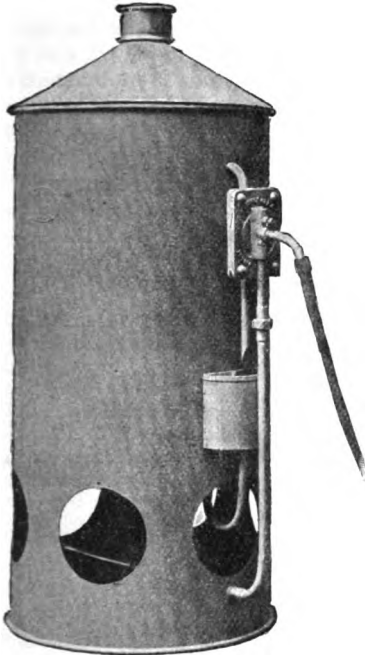

FIG. 5.—Hearson's steamer.

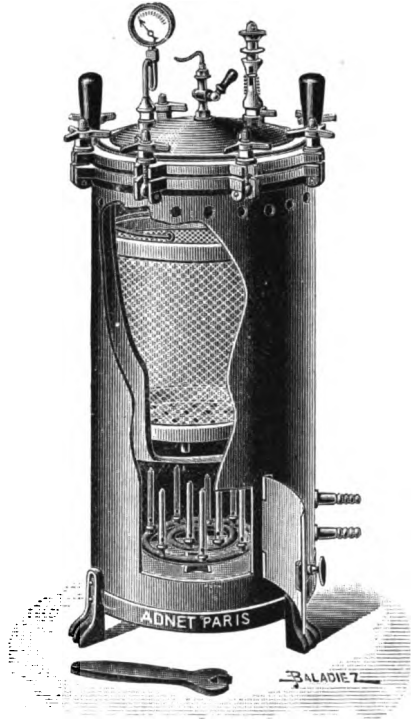

FIG. 6.—Chamberland's autoclave.

Exposure to steam at a temperature of 115° C. for 20 minutes is in most cases sufficient to ensure sterilization, but some media, potato for example, require a temperature of 120° C.

Some of the commoner forms of autoclave may be shortly described here.

Autoclaves.

1. **Chamberland's autoclave** (fig. 6).—This autoclave consists of a cylindrical copper boiler, the free edge of which is turned out flangewise. A flanged bronze cover is secured to this edge by screw bolts, and the whole is made air-tight by the insertion of an india-rubber washer between the two metal flanges.

The cover is provided with a safety valve, a steam tap, and a manometer which records the pressure in atmospheres and the temperature in degrees centigrade. The boiler contains a removeable copper-wire basket, which rests on short feet (5–6 cm.) on the bottom of the boiler. The boiler

itself is supported within a cylindrical sheet-iron or copper furnace provided with one or two rings of Bunsen burners.

Technique.—(a) Pour sufficient water into the boiler to reach to just below the bottom of the wire basket; distilled water is preferable, as by its use furring is avoided.

Place the apparatus to be sterilized in the basket, and lay two or three thicknesses of cloth or paper over the wool plugs to prevent condensation water dropping on to them from the cover.

(b) Adjust the india-rubber washer, put on the cover, and screw up the bolts with the fingers. It is better to use the fingers than the key provided with the autoclave, because with the latter an unnecessary amount of force is very likely to be applied, with the result that the washer is quickly ruined; moreover, careless manipulation with the key will soon strip the screws.

(When the autoclave is not in use, the bolts should remain loosened, and the washer removed and hung up because if left under the cover it gets crushed.)

(c) Open the steam tap.

(d) It will be sufficient to light one ring of burners. Hold the taper to the burner before turning on the gas, and take special notice that the burners do not light below: should this happen, turn out the gas and re-light it.

(e) As soon as the water begins to boil, steam will escape from the tap in the cover, and must be allowed to continue to do so until the pressure of the steam within causes it to issue with a whistling sound in a powerful and continuous jet.

The object of this manoeuvre is to expel the whole of the air from the interior of the autoclave, since if any air remain in the boiler the manometer readings will not be reliable. Still however much care be taken it is impossible to drive out all the air, and the larger the autoclave the larger will be the volume of air remaining. A more effectual means of expelling the air is to compress and decompress repeatedly by opening and shutting the steam tap, but this method should never be adopted when sterilizing fluids because under the influence of a sudden lowering of the pressure the plugs and contents of the flasks and tubes are driven out by the violent boiling of the liquids.

Now close the steam tap. The pressure and temperature will rise rapidly, and when the manometer records the temperature required (115° – 120° C.), lower the gas and regulate it by trial until the manometer reading is steady. Continue the heating at this temperature for 20 minutes.

(f) When sterilization is completed, turn out the gas; the manometer needle soon falls to zero, and then, but not until then, open the steam tap. When all the steam has escaped unscrew the bolts, raise the cover, and remove the contents. If the plugs be damp it is well to put the flasks, etc., in the incubator until the wool dries.

The following minor practical details in the working of an autoclave may be mentioned. It is important never to open the steam tap until the pressure within the apparatus has fallen to the zero mark on the manometer, for the reason already given, namely that under the influence of sudden decompression the fluid contents of the flasks, etc., are liable to be discharged into the autoclave. Again, to avoid accidents by scalding from an escape of steam beneath the cover, the steam tap must always be opened before the bolts are loosened. Lastly, to obviate any difficulty in lifting the cover owing to the rubber washer sticking to the metal, always open the autoclave before the latter gets quite cold.

Note.—The autoclave is also available for sterilization at 100° C. The procedure will be the same as regards the first four steps *a*, *b*, *c*, *d*, but the steam tap must be left open the whole time (30 minutes), and the gas burners regulated so that the pressure as recorded by the manometer needle does not rise above the zero point.

It is obvious of course that a sufficient quantity of water must be put into the boiler before commencing the sterilization. Heating should never be continued for longer than 30 to 40 minutes in case the boiler should boil dry.

2. Ducretet and Lejeune's autoclave.—The principle and working of the instrument are the same as in the case of Chamberland's autoclave. The tall form of boiler however makes it especially useful for the sterilization of long pieces of apparatus and of porcelain filter bougies; as many as thirty of the latter can be accommodated at one and the same time by means of a special pattern of support. The autoclave will withstand a pressure of 3 or 4 atmospheres, and is strong enough to be used for sterilization by means of compressed carbonic acid (d'Arsonval).

To facilitate manipulation, some minor alterations have been introduced in the construction of the newest models of autoclaves. For instance, in one made by Adnet the cover is secured by a gearing controlled by a single screw instead of by bolts. In another, made by Rongier, the cover is fitted with an hinge, and in yet another, by Radas, with a lever.

3. Vaillard and Besson's autoclave.—In large laboratories where, for instance, toxins for immunizing horses in the preparation of therapeutic serums or for other purposes are required in large bulk, and the consumption of media is considerable, it is necessary or at least convenient to have some more commodious form of autoclave than Chamberland's. In such cases Vaillard and Besson's pattern is available (fig. 7).

This autoclave¹ consists of a large cylindrical boiler with double walls. The apparatus to be sterilized is arranged on shelves in a central space. The steam rising from the water in the double bottom ascends between the inner and outer walls, passes through the sterilizing chamber from above downwards, and escapes through a safety valve, the escape being regulated in such a manner that the pressure and therefore the temperature rise gradually. When the temperature reaches 115° C., the safety valve automatically allows the steam to escape sufficiently to prevent any further increase of pressure. The boiler is also fitted with a lateral funnel through which the water may be poured in, a tap by which the level of the water is regulated, a manometer and a safety valve. The construction of this apparatus is such that sterilization is effected in a current of steam, and a further advantage is that all the air is expelled without resort to decompression, the disadvantages of which have already been noted.

Technique.—(a) Place the apparatus in the chamber S, and secure the cover firmly by means of the screw bolts. (b) Open the tap of the lateral supply funnel and pour in water until it runs out at P, which must also have been previously opened; then close both taps and raise the valve D. (c) Light the stove. (In France charcoal is generally used as the source of heat, but the autoclave is also constructed to work with gas.) (d) As soon as the water boils, steam will rise between the inner and outer walls, enter the sterilizing chamber, and escape by way of the tube leading to D. When the pressure is sufficient to cause the steam to issue in a powerful jet, lower the valve D. The temperature and pressure within the autoclave will now rise, and will be registered on the manometer M. The steam escapes more and more violently as the pressure increases, until the temperature for which the valve has been regulated (usually 115° C.) is reached, when the volume of escaping steam is such as to prevent any further rise of temperature. The

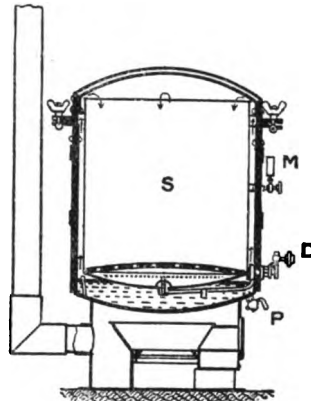

FIG. 7.—Vaillard and Besson's autoclave.

¹ *Annales de l'Institut Pasteur*, 1894.

temperature and pressure must be maintained for 20 minutes, reckoning from the moment when it reaches 115° C. (e) When the necessary time has elapsed, remove the source of heat and allow the autoclave to cool until the pressure reaches zero on the manometer, then open the steam-tap (not shown in the illustration), and raise the cover.

Note.—The autoclave may also be used for sterilization at 100° C. The technique is the same as in the preceding case, except that the valve D is never raised. Under these conditions steam will issue in a powerful jet during the whole operation. The temperature must be maintained for 30 minutes after reaching 100° C.

Sterilization can also be effected at any temperature between 100° and 115° C. by suitably altering the position of the knobbed handle of the valve; the further the handle is from the vertical the less will the temperature rise above 100° C.

Method of controlling the temperatures at which sterilization was effected.

In laboratories where the sterilization of apparatus, etc., is entrusted to laboratory assistants, it is convenient to have a method of controlling the temperature at which sterilization was effected. This may be done by placing a maximum thermometer or, more conveniently, a fragment of fusible alloy or some chemical compound of suitable melting point (110°–120° C.) alongside the apparatus in the autoclave. If a powder be used it may be mixed, as suggested by Demandre, with a trace of some dye, and sealed up in a small glass ampoule. The small amount of dye used is not visible in the powder, but when the latter melts the dye diffuses through it, and on cooling forms a coloured bead.

The following substances are suitable for the purpose, the temperature in brackets indicating the melting point: benzonaphthol (110° C.); antipyrine and sulphur (113° C.); resorcin (119° C.); benzoic acid (121° C.).

For coloured beads the following formulæ may be employed:

| | | | |
|--------------------|--------------------|---|------------|
| Melting at 110° C. | Benzonaphthol, | - | 100 grams. |
| | Safranin, - - - | - | 0·01 gram. |
| Melting at 121° C. | Benzoic acid, - | - | 100 grams. |
| | Brilliant green, - | - | 0·01 gram. |

3. Sterilization by discontinuous heating at low temperatures.

Some substances used as culture media, being rich in albumin, cannot be heated to boiling point without marked alteration and to some extent destruction of their properties. Serum is a case in point.

Pasteur showed that such media can be better sterilized by heating them at a low temperature (55°–60° C.) for a long time than at a high temperature for a short time. This prolonged heating at a low temperature constitutes **Pasteurization**. In practice however it is found that to be effectual, pasteurization must be combined with the method of discontinuous heating devised by Tyndall (p. 7).

Technique.—Distribute the medium into a series of sterile flasks with long necks (fig. 35, p. 46), each flask being about three-fourths filled, and seal the mouths in a blow-pipe. [Flasks and test-tubes covered with india-rubber caps (p. 29) over the wool plugs can be used equally well.]

Place the flasks in a water bath fitted with a thermometer, slowly raise the temperature and regulate the gas flame so that it remains constant at 56°–57° C. for an hour, then turn out the gas, but leave the flasks in the bath until they are quite cool.

The flasks must be heated in the same way daily for a week before the contents can be regarded as sterile; and even then they ought to be incubated at 37° C. for two or three days, and any flask in which a growth appears must, of course, be rejected.

Water baths.

Conducted in the manner described, this method of sterilization is tedious, and it is difficult to avoid exceeding a temperature of 58° C., with the result that the albumin coagulates, rendering the medium useless for the purpose

for which it is required. Hence it is better to have some form of water bath, in which the temperature is automatically controlled by a regulator on the gas supply.

[1. **Hearson's water bath.**—This is a very convenient and reliable form of water bath. It consists of a cylindrical copper vessel (fig. 8) heated below by an ordinary fish-tail gas burner, the temperature being controlled



FIG. 8.—Hearson's water bath.

by a capsule attached to the outside of the bath, and through which the gas passes. The capsule has a range of about 10° C., and within these limits the temperature is regulated by means of a milled screw.

[*Technique.*—Pour sufficient water into the bath to reach above the level of the regulator outside. Put on the lid, and pass a thermometer through the hole in it, being careful to see that the bulb is in the water. Light the gas. The temperature gradually rises until it reaches the point for which the regulator is set: the gas is then automatically lowered and the temperature remains stationary. To raise the temperature, turn the screw clockwise, to lower it, contra-clockwise.

[*Note.*—It must be remembered that the capsule has a working limit of about 10° only, the exact limits being indicated when the instrument is supplied. Consequently, if a bath is required to work sometimes at 55° – 65° C., and at other times at 75° – 85° C., it is necessary either to have two baths, or a single bath in which capsules are interchangeable.

[Be careful always to see that the water is above the level of the top of the capsule, and when filling the bath never add water of a temperature higher than that for which the capsule is regulated.]

2. **Weissnegg's water bath.**—Another form of bath, which is shown in fig. 9, consists of a metal vessel fitted with a Roux's regulator placed in a side chamber, the heat being supplied by a gas burner below.

Technique.—Fill the vessel about three-fourths full of water and immerse the flasks by means of the wire tray, put on the lid, pass a thermometer through the opening provided for the purpose, and light the gas. Watch the thermometer carefully until the desired temperature is reached, then set the regulator in the manner to be described later (Chap. IV.), and no further supervision is required.

The regulator being once set for a given temperature will always work automatically at that temperature until it is again altered, so that beyond lighting the gas and when necessary pouring water into the bath no further manipulation is required.

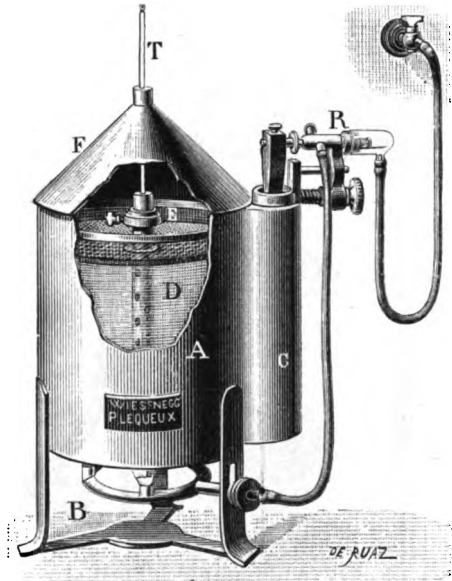

FIG. 9.—Weissnegg's water bath.

Note.—When using the bath for the first time, it is advisable to set the regulator beforehand by means of a blank experiment, thus avoiding accidental overheating of the medium. Sterilization is then carried out as already described, the medium being heated on six or eight consecutive days for an hour each time.

SECTION III.—STERILIZATION BY FILTRATION.

The application of heat in some form is the usual method of sterilization used in bacteriological work, but it sometimes happens that fluids have to be dealt with which cannot be subjected to even a moderate degree of heat without profoundly altering their nature. In order to sterilize such a fluid, it is passed through a solid bougie, the pores of which are so fine that while liquids and solids in solution pass through, micro-organisms are retained. Pasteur in his early work utilized plaster plates as the filtering medium, but as a result of Chamberland's researches porous porcelain superseded plaster.

Filters.

The Pasteur-Chamberland filter consists of a porous porcelain tube or bougie closed at one end but open at the other, and finished at the latter with a nozzle of glazed porcelain. The unfiltered liquid traverses the pores of the bougie from without inwards, and issues from the nozzle filtered and sterilized. The Pasteur-Chamberland bougies are made in two grades of porosity.

That known as the **Chamberland "F"** is the more permeable, and the one generally used both for domestic purposes and for ordinary filtration by aspiration. The less porous and harder bougie, the **Chamberland "B."** is only used for filtration under pressure (*vide infra*), and when manipulating fluids containing exceedingly minute organisms, *e.g.* the organisms of foot and mouth disease, pleuro-pneumonia, horse-sickness, etc. (*vide* "Filtrable Viruses" Chap.LXIV.), which pass through the more porous "F" bougies.

In addition to the Chamberland bougies there are other filters of a similar nature. [The **Doulton white-porcelain filter** (fig. 10) has been found to be "at least as efficient in the retention of micro-organisms as the best material on the market, viz. the Pasteur-Chamberland filter," and to "excel the latter in its rate of filtration."¹]

Another filter, **Garros'**, is made of infusorial earth. This, [like Doulton's] filter, has all the essential properties of a Chamberland filter, and both are used in exactly the same way. The **Berkefeld bougie** is also made of infusorial earth; it is inferior to the Chamberland "B" in that it wears out more rapidly and does not hold back the smallest organisms; on the other hand it filters more quickly than, and does not retain dissolved organic matter to the same extent as, the Chamberland filters. For the latter reason it is especially useful for the filtration of albuminous fluids. [But it must be pointed out that recent experiments have shown that the Berkefeld is not a trustworthy filter.²]

There are several ways in which* these unglazed porcelain and similar filters may be used.



FIG. 10.—Doulton's porous porcelain filter with nozzle.

1. Filtration of water.

Every laboratory has a filter attached to a water tap, for the purpose of readily obtaining a supply of sterile water (fig. 11).

The filter (Chamberland F [or Doulton white]) is contained within a metal cylinder, through the lower end of which it is inserted, and then securely fixed by means of a metal screw-cap, an india-rubber washer intervening; both the washer and metal cap are perforated to allow the passage of the glazed nozzle. The upper end of the metal cylinder is screwed on to a tap connected with the water main. When the tap is turned on, water runs into the space between the cylinder and the bougie, traverses the bougie, on the surface of which the solid matter in suspension is deposited, enters the central cavity, and escapes from the mouth of the glazed nozzle.

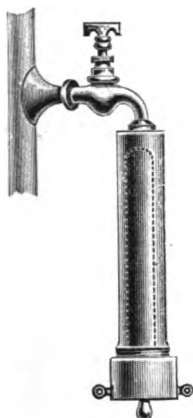

FIG. 11.—A porous porcelain filter attached to the water main: the outline of the filter is shown by the dotted lines and the glazed nozzle is seen projecting below.

Preparation of the filter.—1. Before putting a filter into the metal cylinder it is absolutely necessary to ascertain that it has no fissure or flaw in its substance, because unless it be perfect micro-organisms will quickly find their way through it. To determine whether or

[¹ *Journal of Hygiene*, 1906, 1909.]

[² *Journal of Hygiene*, 1908, 1909.]

no the bougie is sound, attach an india-rubber syringe to the nozzle and immerse all but the nozzle in a cylinder filled with water (fig. 12). By squeezing the syringe air will be driven into the bougie, and if a fissure be present, even

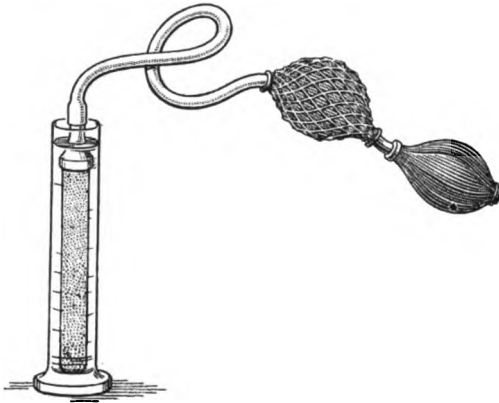

FIG. 12.—Method of testing a porcelain filter.

one so small as to be invisible to the naked eye, bubbles of air will stream out through it into the water and will at once render it apparent. All defective bougies must necessarily be rejected.

2. The filter must then be sterilized. After testing the bougie and while it is still wet, plug the nozzle with dry wool and sterilize in the autoclave at 115°–120° C. for 20 minutes. Fix the bougie in the metal cylinder, withdraw the wool plug, and the filter is ready for use.

3. Before drawing off sterile water, flame the nozzle well with a spirit flame.

Cleansing and renovation of bougies.—1. When in use the external surface of a filter soon gets soiled, and organisms are then likely to find their way through the pores. It is necessary therefore that filters be frequently taken out and cleaned by scrubbing with a stiff brush in a stream of running water, and re-sterilized.



FIG. 13.—A muffle furnace.

2. But this surface cleansing does not prevent the pores of the filter becoming choked after a time, filtration being impeded in consequence; when this occurs a porcelain filter can be renovated by one or other of the following methods.

(a) After scrubbing the filter autoclave it at 120° C., but before taking it out

of the autoclave compress and decompress several times. As far as it goes this is an excellent method for unchoking a filter because there is no risk of damaging its structure, but the regeneration is only partial.

(b) Clean the filter as above, and dry it thoroughly: then heat it to redness in a Bunsen flame. This involves considerable risk of fissuring the filter.

(c) The best method is to heat the bougie to redness in an incinerator [or "muffle" furnace] (fig. 13).

Note.—After regenerating a filter by either of the two last methods it must be re-tested to make certain that it has suffered no damage.

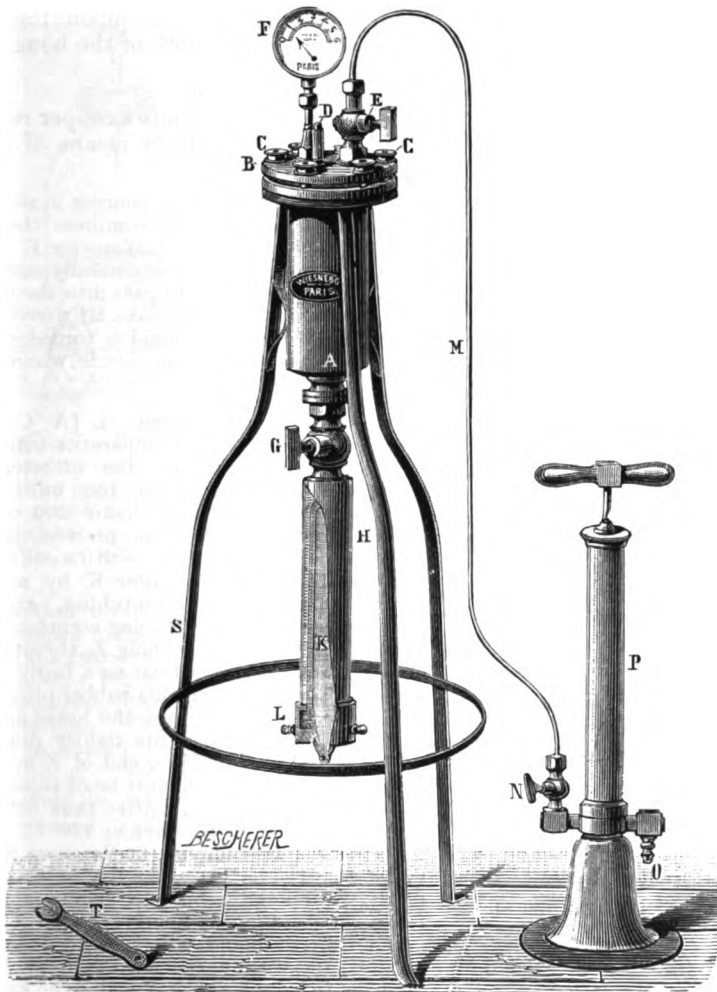

FIG. 14.—Filtration by compression (Gay-Lussac pump).

(d) Lastly, a filter may be regenerated by passing through it a 0.5 per cent. solution of potassium permanganate, followed by a 5 per cent. solution of sodium bisulphite (Guinochet). The method is less satisfactory than the foregoing.

3. Whenever culture media containing micro-organisms have been passed through a filter, the latter must be autoclaved immediately.

Berkefeld bougie.—The Berkefeld bougie does not lend itself to heating in a flame or incinerator. To clean it, it must be brushed with a stiff brush in a solution of sodium carbonate, washed in running water, and then autoclaved.¹

2. Filtration of culture media.

Bougies are also used for rendering sterile media which are to be used for growing cultures, and for freeing a culture medium of the organisms which have been grown in it.

This may be effected in one of many ways; but filtration should always be carried out under pressure either by putting pressure upon the liquid to be sterilized, or by aspirating the filtrate at the mouth of the bougie.

A. Filtration by compression.

The original method was to pour the unfiltered liquid into a copper reservoir A (fig. 14), and then to force it through the filter K by means of a Gay-Lussac pump P.

Technique.—Close the tap G, and half fill the reservoir A by pouring in the liquid through the opening D. Close D by screwing on the cap, and compress the air in A by working the pump P. The pressure can be read on the manometer F. When the necessary pressure has been attained (2 or 3 atmospheres is generally sufficient), close the tap E and slowly open G. This allows the liquid to pass into the filtering chamber H, which contains a sterile Chamberland filter K (size B) fitted up as described above. The liquid is forced through the filter and issues at the nozzle where it can be collected aseptically.

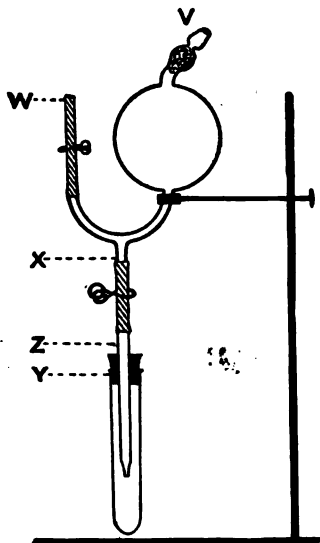

FIG. 15.—Cobbett's bulb with attachments for filtration by compression.

Collection of the filtrate.—1. [A Cobbett's bulb is a useful piece of apparatus with which to collect and distribute the filtrate. The illustration (fig. 15) shows the bulb, which usually has a capacity of about 200 c.c. To render it available for the present purpose, plug the small bulb V with wool, attach W to the nozzle of the filter K by means of stout red rubber pressure-tubing, and with another piece of rubber tubing connect X with a short length of glass tubing Z, the other end of which has been drawn out to a fairly narrow opening. Select a small india-rubber plug Y with one perforation, slip it over the lower end of Z and push it up until it fits tightly round the test-tube, then enclose the lower end of Z in a test-tube the mouth of which must be of suitable size to fit the rubber plug Y. After thus fitting up the filter and bulb, autoclave at 120° C.

[When required for use, fit the filter K in its metal case H (fig. 14), and screw on the cap L firmly. Support the bulb by clamping it to a retort stand. Clip the tubing between X and Z.

[The filtered liquid will be forced into the bulb, the rate being regulated by the tap G, and when nearly filled turn off the tap G; take off the test-tube, and by releasing the clip between X and Z the fluid can

¹ According to Dr. Andrew Wilson, however, it would appear that Berkefeld bougies must not be autoclaved. "It is a well-known fact that in consequence of the composition and the mounting of the Berkefeld filtering cylinders, they do not stand sterilization in an autoclave at 120° C. The only way effectually to sterilize the cylinder without injuring it is to place it in a vessel with cold or tepid water, and to boil it for about an hour" (*Journal of Hygiene*, 1909, p. 33). It has already been stated that simple boiling at 100° C., though prolonged, cannot be relied upon to destroy all micro-organisms.]

be run off into any suitable sterile vessel. When the bulb is emptied, replace the test-tube, tighten the clip, open G, and repeat the operation.]

2. The filtrate may also be collected through a piece of glass tubing connected by a piece of india-rubber tubing a few centimetres long to the nozzle of the filter (fig. 16). The bougie, with rubber and glass tubing attached, is wrapped in paper

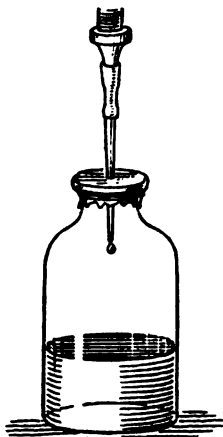

FIG. 16.—Alternative method of collecting the filtrate.

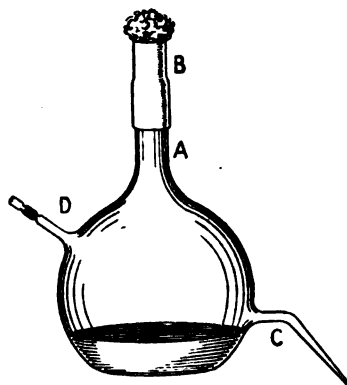

FIG. 17.—Flask with three tubulures for the collection and distribution of the filtrate.

and sterilized. When required for use, the bougie is fixed in its metal cylinder, the paper removed from the rubber and glass collecting tubes, and the latter pushed through the paper cap covering the mouth of the sterile vessel in which the filtered liquid is to be collected. If the collecting vessel be plugged with wool, the tube is inserted between the neck and the plug, the tube being surrounded as completely as possible with wool and pushed downwards until the orifice projects below the wool.

3. Another arrangement is to use a flask with three tubulures, such for instance as that shown in fig. 17. The flask must of course be sterile; the wool in the mouth of the india-rubber tubing B is removed, and the tube itself attached to the nozzle of the filter. When filtration is completed the tubing is removed from A, which is then plugged with a sterile plug, all necessary precautions being taken to prevent contamination. To manipulate the filtrate the tubulure C is broken and the liquid run out by simply inclining the flask. The third tubulure D is plugged with wool.

Filtration by compression involves the use of a costly piece of apparatus, and is limited in practice to the filtration of viscous fluids.

B. Filtration by aspiration.

Aspiration is the means usually employed for the filtration of fluids. The methods by which the principle of filtering by aspiration is applied vary in detail, and the technique of a few of the simplest and easiest devices will be described.

[1. Fit up and sterilize a Cobbett's bulb exactly as described for filtration under pressure (p. 18), and clamp it to a suitable stand. Connect the bulb to a wash-bottle with a piece of red rubber pressure-tubing, but between the bulb and the wash-bottle insert either a three-way tap or a T-piece of glass tubing the vertical limb of which is closed by india-rubber tubing and a clip, then connect the wash-bottle to the pump.

[*Technique.*—Stand the filter F in a tall glass cylinder C which must be rather larger than the filter, and fill up the cylinder with the unfiltered liquid. Tighten the clip K on the vertical limb of the T-piece and also the clip H of the delivery tube, and turn on the water. The liquid is thus aspirated

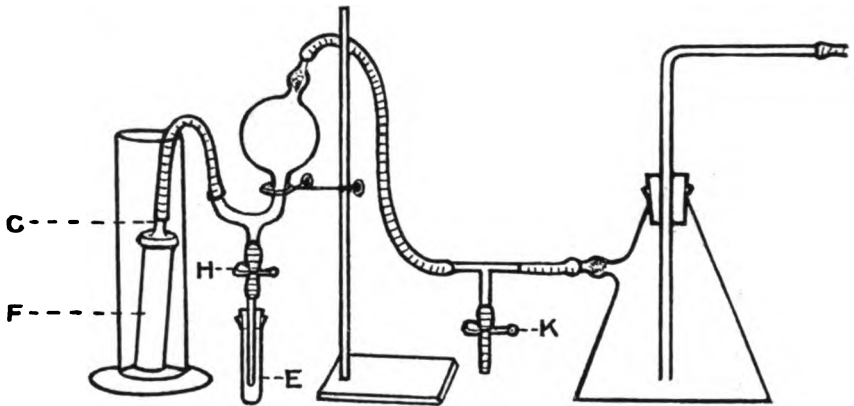

FIG. 18.—Cobbett's bulb fitted up for filtration by aspiration.

through the filter into the bulb. When the bulb is nearly full, gently release the clip K on the vertical limb of the T-piece, and then turn off the water. Then, as before (p. 18), remove the test-tube E and draw off the filtrate into suitable and previously sterilized vessels. Having emptied the bulb replace the test-tube E, tighten the clips K and H, turn on the water and exhaust again. In case the filtrate or a part of it has to be stored for future use, the vessels in which it has been collected may be sealed off in the flame of the blow-pipe, or the wool plugs can be made air-tight to prevent evaporation by sealing them with paraffin or sealing-wax (p. 30).]

[2. Instead of a Cobbett's bulb, an Erlenmeyer flask may be used, but the procedure is a little more complicated (fig. 19). The filtrate is aspirated into an Erlenmeyer flask, and then blown out with a bicycle pump.

[*Technique.*—(a) Take an Erlenmeyer flask of sufficient size to contain the filtrate. Plug the lateral tubulure with wool between the constrictions.

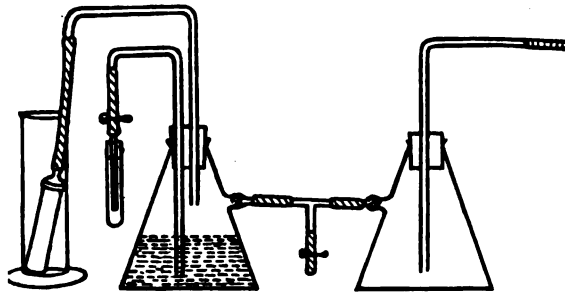

FIG. 19.—A convenient arrangement for filtration by aspiration.

Fit the mouth with an india-rubber bung with two holes; through one hole pass a piece of glass tubing bent at a right angle, the vertical limb of which is long enough to reach to the bottom of the flask, and through the other

another piece of glass tubing also bent at a right angle, the vertical limb of which reaches only just below the level of the lateral tubulure. To the horizontal arm of the latter attach a piece of red rubber pressure-tubing, which at its other end is connected to the nozzle of the filter. To the other piece of glass tubing attach another piece of pressure-tubing, into the distal end of which is inserted a short piece of glass tubing drawn out to a narrow orifice; over this glass tube an india-rubber plug is slipped to fit a test-tube which protects the end of the delivery tube.

[(b) Sterilize in the autoclave at 120° C.

[(c) Attach the lateral tubulure of the flask to the lateral tubulure of another Erlenmeyer flask with pressure-tubing, and insert a three-way piece of glass tubing between the two flasks, the vertical limb being closed with rubber tubing and a clip. Pass a right-angled piece of glass tubing through an india-rubber bung in the mouth of the flask, and attach this tubing to the pump by means of pressure-tubing.

[(d) Place the filter in a glass cylinder larger than the filter, and fill up the cylinder with the fluid to be filtered. Secure the two clips.

[(e) Turn on the pump, and the fluid is aspirated from the cylinder to the Erlenmeyer flask. When the fluid reaches nearly up to the level of the lateral tubulure, release the clip on the vertical limb of the three-way piece of glass tubing. Disconnect the second flask, and attach a bicycle pump to the first flask. Clip the tubing attached to the filter.

[By working the pump the flask can be filled with air—filtered by passing through the wool plug in the lateral tubulure—and the contents of the flask thus put under sufficient pressure to allow them to be drawn off through the tube contained in the test-tube, as in the former case.]

3. A third method is to attach one end of a piece of red rubber pressure-tubing B (fig. 20) to the nozzle of a filter, and the other end to a piece of

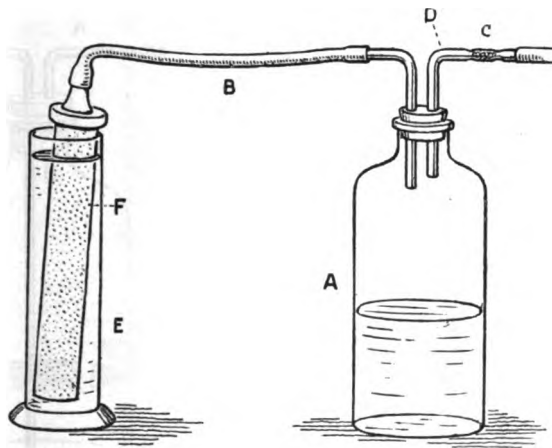

FIG. 20.—Filtration by aspiration.

glass tubing bent at a right angle. Pass the latter through one of the holes in an india-rubber bung. Fit the bung tightly into the neck of a stout white-glass bottle A the capacity of which is equal to the amount of fluid to be filtered (thin-walled flasks will not withstand the pressure, and should therefore never be used for this purpose). Through the other hole in the bung pass

another piece of glass tubing also bent at a right angle; the vertical branch should reach a few centimetres below the bung, while the horizontal arm has two constrictions with a fairly tight plug of wool C between them.

The apparatus thus fitted up is heated in the autoclave at 120° C. for 20 minutes. When cool, it is examined to see that the bung still fits tightly, and the apparatus is then ready for use.

Technique.—Stand the filter F in a glass cylinder E which must be rather larger than the filter, and fill up the cylinder with the unfiltered liquid. Connect the horizontal limb of the tube D by means of pressure-tubing with a water pump (Chap. VI.) and exhaust. The liquid is thus aspirated through the filter into the bottle A.

When the liquid has all passed through, turn off the water and disconnect the tubing connecting the bottle and the pump (the air which will then enter the bottle is filtered through the wool plug C between the constrictions). Flame the neck of the bottle, and replace the bung either by a previously sterilized wool plug or by another bung so arranged that the fluid can be manipulated as described later. The liquid thus sterilized by filtration can be kept sterile indefinitely in the bottle.

There is always a little liquid left in the filter, and if necessary this can be collected by disconnecting the tube B from the nozzle and aspirating the fluid into a long sterile bulb pipette (fig. 21).

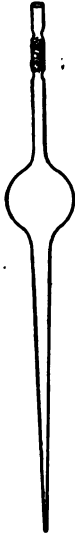

Fig. 21.—Bulb pipette.

Distribution of the filtrate.—Having obtained a sterile filtrate, it follows that the subsequent manipulations must be so devised as not to contaminate it. The methods to be employed will now be described.

The bung used during filtration (p. 21) must be replaced by another fitted in the following manner. Take an india-rubber bung perforated with two holes of the same size as the one to be replaced. Through one hole pass a piece of glass tubing A (fig. 22) bent at a right angle and having a cotton-wool plug between constrictions in the horizontal arm. Through the other hole pass another piece of glass tubing B bent in the form of an inverted open U, one limb of which should reach nearly to the bottom of the bottle while the other, which will be outside the bottle, is drawn out to a fine capillary point and sealed. Wrap the bung with its glass tubes *in situ* in paper, and autoclave at 120° C.

Flame the neck of the bottle, remove the paper covering from the sterilized bung, and hold the latter by its upper part in the left hand. Take out of the bottle with the right hand the bung used for filtration, and replace it by the other as quickly as possible in order to prevent dust falling into the bottle. Care must of course be taken that during these manipulations the new bung with its tubes comes in contact with nothing likely to soil it.

To withdraw the fluid, it is only necessary to connect an india-rubber syringe to the tube A, and after flaming the capillary end of B to break off the point with a pair of sterile forceps. By squeezing the syringe a few times the liquid will be forced out through B. When the quantity required

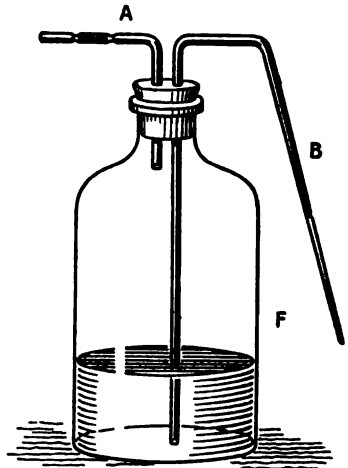

Fig. 22.—Distribution of the filtrate.

has been withdrawn the end B is sealed in a Bunsen flame thus effectually excluding air from the bottle.

It may however sometimes happen that on ceasing to work the syringe some air will enter the bottle through B, and since this may carry organisms with it there is a risk of the liquid in the bottle becoming contaminated. The difficulty is easily overcome by the following simple device.

Before being sterilized the external limb of the tube B is cut in the middle, and the two ends B and C (fig. 23) connected by means of a piece of red rubber tubing, into which a short length (1-2 cm.) of glass rod D has already been introduced. When not in use the glass rod completely obliterates the lumen of the rubber tubing, and cuts off all communication between the outside air and the contents of the bottle. But if the rubber tubing be pinched between the thumb and index finger, a small channel is formed through which the liquid can be forced by squeezing the syringe attached to A (fig. 22). The apparatus would then be worked as follows:

The end of the glass tubing C being flamed and the point broken off, the syringe is squeezed a few times, and then the india-rubber tubing between B and C pinched up. The liquid will then run out from the open end. The flow of liquid is stopped by first releasing the finger and thumb from the india-rubber tube, thus cutting off all communication with the outside air, and then but not till then relaxing the pressure on the syringe. Finally, the broken end is sealed and the syringe disconnected.



FIG. 23.—
Stopper for use
with distribut-
ing plug.

4. **L. Martin's filtering apparatus** (fig. 24).—This consists of a porcelain

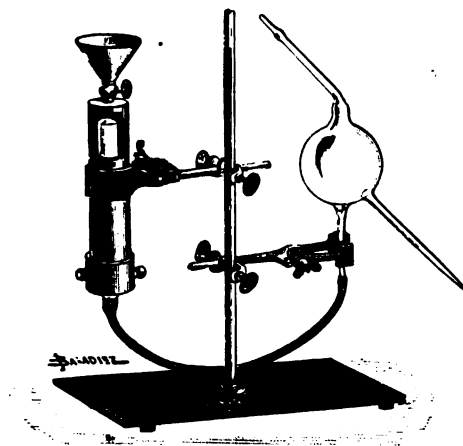

FIG. 24.—L. Martin's filter.

(The upper tubulure of the bulb should have a wool plug between constrictions: this has been accidentally omitted from the figure.)

filter contained in a metal cylinder similar to that described before (p. 15). The cylinder has a tap funnel screwed into the top to facilitate manipulation.

Technique.—Connect the nozzle of a porcelain filter with a bulb of the shape shown in the figure by a length of pressure-tubing. Sterilize in the autoclave. Then fix the filter in its metal case, and connect the upper tubulure of the bulb to a water pump with pressure-tubing.

Fill the cylinder through the funnel with the fluid to be filtered, close the tap and turn on the water. The fluid in the cylinder is aspirated through the filter, along the tubing, and so into the bulb. When all the liquid has been aspirated, turn off the water, open the tap, and disconnect the bulb from the water pump. The lower tubulure of the bulb is sealed during filtration, but is flamed and the point broken off with sterile forceps before distributing the filtrate.

This is a useful piece of apparatus, but its cost is a disadvantage.

5. Chamberland's method.—If water be not available, a small hand pump, *e.g.* Potain's, may be used for aspiration. Place the filter B (fig. 25) in a

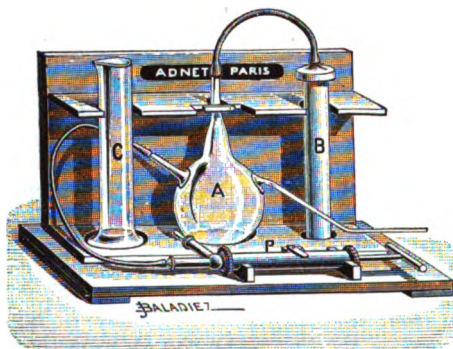

FIG. 25.—Chamberland's filter.

tall glass cylinder C, and fill up the latter with the liquid to be filtered. On working the aspirator the fluid is drawn through the filter into the flask A, which has three tubulures. The filter and flask must both be sterilized in the autoclave before use.

[It will be obvious, of course, that Cobbett's bulb can be used equally with a hand or water pump.]

3. The filtration of small quantities of liquid.

The laboratory bougie.—When only very small quantities of liquid have to be filtered, as for example in testing a toxin, a small thin-walled bougie 12–15 cm. long and without a nozzle is very useful.

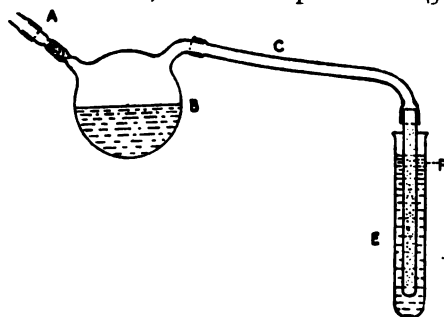

FIG. 26.—Laboratory bougie for filtering small quantities of liquid.

B. The filter may also be arranged as shown in fig. 26. As in A, a piece of pressure-tubing is firmly fixed by one end to the upper end of the filter, but the other end is attached to one of the two tubulures of the flask B. The other tubulure A is plugged with cotton-wool and connected to a water pump or a small aspirator, *e.g.* Potain's. Sterilize the apparatus before use.

C. Duclaux's filter.—The filter can also be fitted to a flask with three tubulures (fig. 27). In this case the open end of the filter is wrapped round with cotton-wool, which serves to hold the bougie in position in the neck of the upper tubulure E. The tubulure D is sealed, and B is plugged with wool. After autoclaving, the wool packing around the neck of the filter F is made air-tight by running a little melted

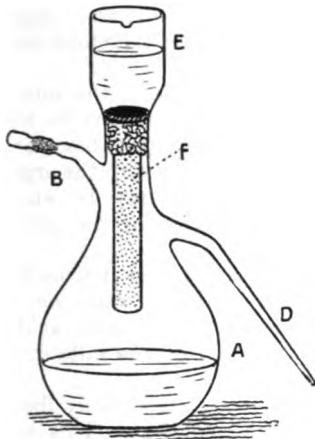

FIG. 27.—Laboratory bougie—Duclaux's arrangement.

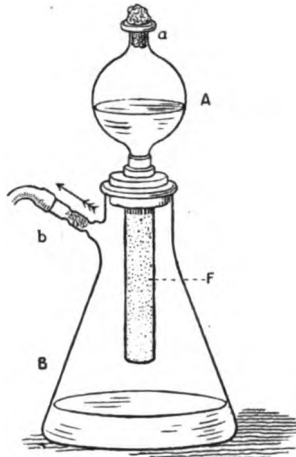

FIG. 28.—Laboratory bougie—Kitasato's arrangement.

wax ([paraffin or] Golaz's) over it. The tubulure B is connected to a water pump, and the liquid to be filtered poured into E. On turning on the water the liquid is drawn through the filter and collects in the flask. To distribute the filtrate, break off the sealed end D and blow air into the flask through the wool-plugged orifice B.

D. Kitasato's filter (fig. 28) consists of a conical flask of thick glass furnished with a lateral tube *b*, which when in use is plugged with wool and connected to a water pump.

The wide neck of the flask is fitted with a perforated india-rubber bung through which the filter F is passed. The mouth of the filter is attached by means of another india-rubber bung to a glass bulb A. The technique is very simple: pour the liquid into A, turn on the water pump, and the filtrate collects in the flask B. The apparatus must of course be autoclaved before use.

E. Martin's filter (fig. 29), as arranged for dealing with small quantities of fluid, consists of a tube R, which can be connected to a water pump through the tubulure A. Within it is a moderately large test-tube T resting upon a pad of cotton-wool. A small filter F is passed into the test-tube, and firmly fixed in the mouth with the open end upwards. The tube R is closed above with an india-rubber bung, through which passes a glass funnel E the lower end of which is connected with the upper (open) end of the filter. The liquid to be filtered is poured into E, and being drawn through the filter collects in the tube T.

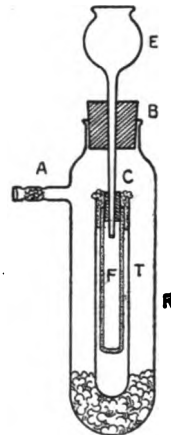

FIG. 29.—Laboratory bougie—Martin's arrangement.

To sum up, there are three important considerations to be kept in mind when using a filter for purposes of sterilization.

- (1) In every case the filter must be tested to make sure it is sound and free from fissures;
- (2) filters must always be sterilized immediately before use;
- and (3) subsequent contamination of the filtrate must be carefully guarded against.

SECTION IV.—STERILIZATION BY ANTISEPTICS.

Sterilization by antiseptics has but limited use in bacteriological work. The addition of antiseptics will not truly destroy micro-organisms in a medium designed for the growth of cultures, but the amount of antiseptic which has to be added to effect this result is very much greater than the amount required to inhibit the multiplication of any organisms which may subsequently be sown in it; the medium is therefore rendered useless.

1. Antiseptics are, however, in general use for sterilizing the interior of glass dishes, bell jars, and other similar articles which are to be used to protect from dust and contamination Petri dishes, culture tubes, etc., and which will not come in contact with any culture medium, or with the organisms under investigation. Fixed non-volatile antiseptics must be employed since the vapours given off by volatile compounds hinder the growth of organisms on culture media.

A 0·1 per cent. solution of perchloride of mercury may be used. The solution should be made with distilled water, but if tap water be used a small amount (0·5–1 gram) of tartaric, acetic or hydrochloric acid must be added to prevent precipitation of the mercury salt by the salts dissolved in the water.

Perchloride of mercury has however now been almost entirely discarded in favour of oxycyanide of mercury in 0·1 per cent. solution. This solution though powerfully antiseptic has no caustic action, it does not precipitate albuminoid substances, neither does it attack instruments and other metal articles.

2. Antiseptics are also in general use for sterilizing the hands, and for washing out vessels and sterilizing instruments during inoculation and other experiments. Solutions of 0·1 per cent. of perchloride or oxycyanide of mercury or 1·5 per cent. of formalin are often used for these purposes.

[Lysol, a solution of the three cresols in soap and water, is a particularly useful antiseptic. In 2 per cent. solution it does not hurt the skin, and the soap in solution makes a lather if the hands be washed in it or if the surface of the skin be rubbed with a sponge soaked in the solution; the presence of the soap makes a solution of lysol a more efficient antiseptic for these purposes than mercury solutions. Lysol does not damage metal instruments, and does not precipitate albuminoid solutions. If made up in large quantities with hard water the soap is liable to be precipitated to some extent, but the antiseptic constituents still remain in solution.]

Solutions of perchloride or oxycyanide of mercury may also be used for sterilizing the surface of the skin before collecting pus, blood, etc., from the living subject (Chap. XII.). Care must of course be taken that, after sterilization, all traces of the antiseptic are removed by washing the part well with alcohol before collecting the material, otherwise the presence of the antiseptic would materially interfere with the subsequent growth of organisms in culture. [At the present time, however, it is more usual to paint the surface of the skin with tincture of iodine (British Pharmacopœia) before penetrating it for the purpose of collecting material for bacteriological investigation.]

3. Antiseptics are also added to sterile filtrates which are no longer required as culture media. For this purpose a small quantity of some antiseptic (such as thymol or camphor) which is without chemical action on the constituents of the fluid is selected.

[Wright adds a trace (0·5 per cent.) of carbolic acid to his vaccines.]

4. Antiseptics are sometimes used to sterilize a culture when the products of micro-organisms are under investigation. Volatile antiseptics such as chloroform, ether, toluol, essence of garlic or mustard, etc., which can be readily driven off afterwards by evaporation, are the most useful in this connexion.

CHAPTER II.

CULTURE MEDIA.

Introduction.

Section I.—Liquid media, p. 30.

1. Media made from animal tissues and fluids, p. 30. 2. Media made from vegetable tissues, p. 37. 3. Synthetic media, p. 38.

Section II.—Solid media, p. 39.

1. Gelatin media, p. 39. 2. Agar media, p. 42. 3. Media made from albuminous fluids and tissues,—serum, egg, etc., p. 45. 4. Media made from vegetable tissue, p. 55. 5. Coloured media, p. 56.

THE substances requisite for the growth of micro-organisms may be obtained by macerating, infusing or boiling tissues of animal or vegetable origin. Saline solutions in which some carbo-hydrate is dissolved also supply all the ingredients essential for a culture medium.

Culture media are either solid or liquid.

Chemically, like all other living cells, micro-organisms consist of organic and inorganic nitrogen and mineral salts; it is therefore necessary in order to grow a micro-organism that these three classes of substances be made available, together with oxygen which is an essential to the life of all living structures. [Finally, a certain amount of moisture is absolutely necessary.]

Micro-organisms are divided into two large groups, the members of one of which derive their oxygen, like more highly organized structures, from the free oxygen of the atmosphere, while the members of the other group cannot multiply in presence of free oxygen, but obtain the oxygen they require by the decomposition of substances containing it (Pasteur). The former are known as the aerobic, the latter as the anaërobic organisms.

These two groups of micro-organisms call for very different methods of artificial cultivation. Aerobic micro-organisms should be grown in vessels in which there is an ample supply of air; anaërobic micro-organisms on the other hand only grow if air be excluded. The latter therefore are cultivated either *in vacuo*, or in presence of some inert gas.

The constituents of culture media are however the same for both aerobic and anaërobic organisms and ought to include nitrogen compounds and salts of the ternary bases. Many organisms can convert inorganic nitrogen (nitrates, etc.) into organic nitrogen, while in some cases organisms will grow in purely inorganic solutions provided these contain a small quantity of some carbohydrate such as sugar.

General Rules.—Every culture medium therefore must

(1) *contain the substances necessary for the growth of the organism to be sown* [(2) *be of suitable reaction*]; (3) *have been previously sterilized*; (4) *be contained in vessels which afford protection from contamination from without.*

Culture vessels.

Vessels of various patterns are used for culture media, and these will be described as occasion for their use arises. In this chapter a description of those most commonly used for the growth of aërobes only will be given.

1. **Ordinary test-tubes**, but without lips, are in constant use (fig. 30); they must be plugged with wool as already described.

2. **Erlenmeyer flasks**—conical glass vessels with a flat bottom (fig. 31) and of different sizes—[and **Jena flasks**,] are also in frequent use. Ordinary small



FIG. 30.—Culture tube plugged with wool.

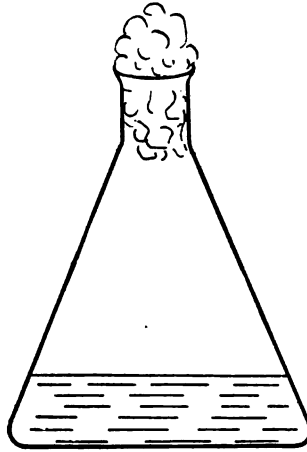

FIG. 31.—Erlenmeyer flask.

medicine bottles of 30 to 50 c.c. capacity can be used in many cases. Whatever be the shape of the vessel it must be plugged with wool, and as a further protection a paper cap is useful (*vide* p. 4).

3. Small vessels capable of holding 30 to 50 grams and known as Pasteur's flasks, are also in frequent use [in France]. The mouths of these flasks are generally closed by means of an hollow ground-glass stopper fitting a similarly ground-glass surface on the neck of the flask, and having a small orifice above, which must be plugged with wool. This method of plugging effectually preserves the contents of the flasks from contamination, but has the disadvantage of being very fragile, and the glass cap is often broken in the flaming process preliminary to opening the flask.

It is better to cover the mouth of the flask with a small paper hood (this can be done by enveloping the neck in a small strip of filter paper and tightly screwing the projecting part into a point). It is even simpler to plug the flasks with wool in the same way as test-tubes are plugged.

Miquel's flask is merely a conical form of Pasteur's pattern.

Prevention of evaporation.

Evaporation readily takes place through a wool plug, and if a medium—especially a solid medium such as potato, serum, agar, etc.—be stored or incubated for a long time, the amount of evaporation is likely to be excessive. To avoid this, the mouth of the vessel may be closed with an india-rubber cap. This must be sterilized before use, because when the cap is slipped over the mouth of the tube or flask the air within being saturated with aqueous vapour will soon make the wool plug moist, and then any organism on the inner surface of the cap will ultimately grow through the moist plug and contaminate the contents.

Red rubber caps are the best; they should be put into a wide-mouthed flask or bottle, which is then plugged with wool and autoclaved and afterwards put in the incubator to dry the plug. A cap can then be taken out with a pair of sterile forceps whenever one is wanted.

In the case of stock cultures, which are to be put away for some time, evaporation may be prevented by pouring a little melted **paraffin** [or **sealing-wax**] over the top of the plug.

[This latter method of sealing tubes or bottles is also of great use in the cultivation of slow-growing organisms such as the tubercle bacillus. After sowing the medium, the top of the plug is carefully sealed with melted paraffin (or sealing-wax), and the culture can then be incubated as long as is necessary without fear of the medium drying up, if the sealing has been efficiently done.]

Method recommended.—[When **paraffin** is used, gently warm the upper $\frac{1}{2}$ cm. of the tube by turning it round in the flame, and then with a pipette or ladle pour a few drops of melted paraffin, kept liquid in a water bath, on to the warm wool and let it soak in to a depth of $\frac{1}{2}$ cm. or so. To unseal the plug, gently warm the upper part of the tube again, stick a needle or pair of forceps into the plug and turn it round at the same time raising it.

[Another simple method of preventing evaporation during cultivation in test-tubes is to place them in a large wide-mouthed ground-glass **stoppered jar**, which has been previously thoroughly washed out with a saturated solution of perchloride of mercury. Place two or three folds of filter paper moistened with perchloride solution at the bottom of the bottle, and after arranging the tubes put a trace of vaseline on the stopper and close the bottle, turning the stopper round to obliterate any air channels. Volatile antiseptics (*e.g.* formalin) are obviously unsuitable for this purpose.]

SECTION I.—LIQUID MEDIA.¹

1. Media made from animal tissues and fluids.

There is a great variety of these media. A description of those in most general use only will be given here; and the most frequently used of all, peptone beef broth, will be taken as a type and the technique of its preparation given in fullest detail.

Peptone beef broth.

This medium is in everyday use. It will be referred to in future simply as **broth**.

Preparation.—1. Take 500 grams of lean beef. Cut away all fat, tendon and aponeurosis. Mince it, and leave it to macerate in a litre of cold water for 6 to 12 hours.

2. Heat gently to boiling in an enamelled saucepan, stirring constantly, and keep the mixture boiling for 10 minutes.

3. Pour on to a thick clean cloth, express as far as possible all the fluid out of the meat, and while still warm filter the fluid through a thick filter paper (Chardin or Prat-Dumas) moistened with water to keep back the fat.

4. Pour the filtered broth into an enamelled saucepan, and add

| | | | | |
|--------------------------|---|---|---|---|
| Dry peptone (Chapoteaut) | - | - | - | 10 grams, or 1 per cent. of the volume of water used. |
| Salt, | - | - | - | 5 grams, or 0.5 per cent. |
| Sodium phosphate, | - | - | - | about 1 gram. |

Boil again, stirring meanwhile to dissolve the peptone

¹ The present chapter will be limited to a description of the culture media of general application. Media applicable only to particular organisms will be dealt with when the latter are under consideration.

The addition of the sodium phosphate is not absolutely necessary. Cache states that the addition of magnesium salts increases the value of the culture medium, and advises the addition of 2 grams of magnesium phosphate per litre to ordinary broth, in place of the sodium phosphate. Magnesium phosphate should be added while the meat is macerating (Stage 1 above).

5. The liquid is now strongly acid and must be neutralized, since bacteria grow best in a *neutral or slightly alkaline medium*.

Neutralization.—To neutralize the medium, add normal soda solution to the broth in small quantities at a time with a pipette, testing the reaction at frequent intervals against litmus paper. When a drop of the broth placed on a red litmus paper with the end of the stirring rod turns it slightly blue, sufficient soda has been added. The reaction should be very slightly alkaline to litmus, but acid to phenol-phthalein.

Neutralization is the most difficult step in the preparation of broth. The amount of alkali to be added varies considerably with different pieces of meat, and can only be determined by trial. Add the soda solution very slowly stirring carefully after each addition; and as the neutral point is approached, test the broth after the addition of each drop of alkali against both a red and a blue paper. A point is ultimately reached when a drop of the liquid produces no change on either paper; it is then sufficient to add a very small quantity of soda solution to attain the requisite degree of alkalinity. According to Park and Williams, 7 c.c. per litre of normal soda should be added to a neutral broth to obtain the most favourable medium.¹

[Eyre uses phenol-phthalein as the indicator and standardizes after Stage 3 before the addition of peptone and salt.

[**Technique.**—1. Heat the meat extract in the steamer at 100° C. for 45 minutes.

2. Measure 25 c.c. into a beaker and add about 0.5 c.c. of a 0.5 per cent. solution of phenol-phthalein in 50 per cent. alcohol.

3. Immerse the beaker in a water bath and raise to boiling point.

4. Neutralize at the boiling point with deci-normal NaOH solution.

[The *reaction* is expressed by stating the number of cubic centimetres of *normal alkali* required to render *one litre* of the meat extract exactly *neutral* to phenol-phthalein.

[For the majority of organisms a medium which requires the addition of 10 c.c. of normal alkali per litre of meat extract is found to be the best. In Eyre's scale the reaction of such a medium is expressed as +10: + indicating that the medium is acid and 10 that it is acid to the extent of 10 c.c. of normal alkali per litre.]

6. Now pour the slightly alkaline broth into a glass flask, or better into an enamelled vessel, and autoclave at 115°–117° C. for 5 minutes. The liquid becomes cloudy and deposits crystals of earthy phosphates.

On taking out of the autoclave, filter while hot through a Chardin paper moistened with water: the filtrate should be absolutely clear. The object of this procedure is to remove any excess of earthy phosphates, and if omitted, the broth is likely to become cloudy when sterilized.

7. Add sufficient distilled water to the filtrate to make the total volume up to 1 litre.

8. This completes the preparation of the broth, which has now only to be distributed into suitable vessels and sterilized.

Sterilization.—(A) If the broth is to be kept for future use, it may be sterilized in a large flask the neck of which is either plugged with wool or drawn out in the flame and sealed. The medium can thus be kept indefinitely, and when required for use can be distributed into suitable vessels.

(B) It is however usually more convenient to distribute the broth at once into test-tubes or small flasks.

¹ Normal soda contains 40 grams of NaOH per litre of distilled water.

1. Into each test-tube put 10–15 c.c. of broth, and into each flask 25 c.c.

A small glass funnel should be utilized for distributing the broth, because if a drop of it come in contact with the wool plug it will when dry cause the wool to stick to the mouth of the tube, so that the plug can only be removed with difficulty. (The use of a funnel is even more important when solid media, such as agar or gelatin, are being tubed.)

2. Plug the tubes and flasks with wool.

3. Place the vessels containing the medium in a wire basket, and autoclave for 20 minutes at 110°–115° C., taking care that the latter temperature is not exceeded, and that the precautions noted in Chapter I. are observed.^{1 2}

Veal broth.

For the preparation of veal broth proceed as for beef broth, using instead of beef 500 grams of lean veal.

Chicken broth.

Chicken broth is prepared in a similar manner, using 500 grams of chicken meat. All skin, tendon, and bone must be removed, otherwise the broth will be of a gelatinous consistency.

Giblet broth.

Liver, spleen, etc., may be used for making broth. The technique is the same as in the preceding cases, substituting 500 grams of the solid organs for beef or other meat. Very often these broths exhibit a slight cloudiness, but this cannot be avoided.

Meat extract.

1. To 500 grams of well-minced lean beef or veal, add 1000 grams of water, and leave in the ice chest to macerate for 12 hours.

2. Shake the mixture, filter through a cloth and squeeze all the fluid out of the meat, then filter through a Chardin paper.

3. Add 5 grams of salt to the filtrate, and heat to boiling.

4. Neutralize as in the case of peptone beef broth.

5. Autoclave for 5 minutes at 115°–117° C.

6. While warm, filter through a moistened Chardin filter paper.

7. Add sufficient distilled water to make up the volume to a litre.

8. Distribute in tubes and sterilize at 110°–115° C.

Martin's peptone solution.

Pigs' stomach broth.

1. Wash, clean and mince finely 4 or 5 pigs' stomachs.

It is better to use a number (5) of stomachs in order to neutralize variations in their pepsin content; if this be done, the broths will have an almost constant average composition.

2. Mix the following :

| | |
|-------------------------------------|------------|
| Minced stomachs, - - - - - | 200 grams. |
| Hydrochloric acid (pure), - - - - - | 10 " |
| Water at 50° C., - - - - - | 1000 " |

and keep the mixture at a temperature of 50° C. for 20–24 hours.

¹ Sometimes it will be noticed that the medium when taken out of the autoclave is very slightly cloudy; this will vanish on cooling. But if during sterilization the temperature exceed the temperature of the first autoclaving (par. 6, above), the broth remains permanently cloudy.

² In England it is more usual to sterilize media by steaming for 20 minutes on each of three successive days in a Koch's steamer, or some suitable modification of it (Chap. I.).

3. Then heat to boiling to destroy the excess of pepsin, and pass through a sieve or a thin layer of loosely packed absorbent cotton-wool.

4. Heat the filtrate to 80° C., and neutralize at this temperature: large flocculent masses are precipitated; filter the clear supernatant fluid through a Chardin paper.

5. Autoclave the filtrate for five minutes at 117°–120° C., and again filter through a Chardin paper.

6. Distribute the clear filtrate in tubes, and sterilize for 15 to 20 minutes at 115° C.

Martin's peptone broth.

1. Mince 500 grams of lean veal, and macerate in 1000 grams of water for 15 to 20 hours at a temperature of 35° C. to get rid of the sugars.

2. Filter through a cloth, squeeze out as much of the fluid as possible, and add 5 grams of salt.

3. Mix this liquid with an equal volume of Martin's peptone solution (see above, Stages 1, 2, 3, 4).

4. Heat to 70° C. to coagulate the albuminoid compounds, and make exactly neutral. Then add 7 c.c. of normal soda solution per litre. Filter through a Chardin paper.

5. Sterilize by filtering through a Chamberland bougie (Chap. I.), and distribute in sterile culture vessels.

Note.—A broth prepared in this way is particularly useful for the preparation of diphtheria toxin.¹ For everyday use, it is simpler to sterilize by heat. After Stage 4 proceed thus:

5a. Pour the broth into an enamelled vessel or flask, autoclave for 5 minutes at 115°–117° C., and filter in the warm through a Chardin paper.

5b. Distribute the filtered liquid into culture vessels and sterilize for 20 minutes at 110°–115° C. The broth is often slightly and permanently cloudy.

Koch's peptone solution.

1. Dissolve in the warm, 10 grams of peptone (Witte or Chapoteaut) and 5 grams of salt in 1000 grams of water.

It is unnecessary to neutralize: peptone itself is sufficiently alkaline.

2. Boil. Filter.

3. Distribute in tubes or flasks. Sterilize at 115° C.

Metchnikoff's peptone-gelatin medium.

1. Dissolve in the warm, in 1000 grams of water,

| | | | | | | | |
|--------------------------------|---|---|---|---|---|----|--------|
| Peptone (Chapoteaut), | - | - | - | - | - | 10 | grams. |
| Salt, | - | - | - | - | - | 5 | " |
| Gelatin (extra quality white), | - | - | - | - | - | 20 | " |

2. Make very slightly alkaline with normal soda solution.

3. Autoclave for 5 minutes at 115° C. Filter through Chardin paper.

4. Distribute in suitable vessels. Sterilize at 110°–115° C.

Miquel's peptone solution.

1. Dissolve at a moderate heat in a litre of water,

| | | | | | | | |
|-----------------------|---|---|---|---|---|----|--------|
| Peptone (Chapoteaut), | - | - | - | - | - | 20 | grams. |
| Salt, | - | - | - | - | - | 5 | " |

2. Add 0.10 gram of wood ash. Boil. Filter through Chardin paper.

3. The liquid is now generally markedly alkaline. Neutralize very carefully with a solution of tartaric acid, watching the reaction meanwhile by testing against litmus paper.

¹ Numerous formulæ for the preparation of broth suitable for the study of diphtheria toxin have been published (Chap. XV.).

4. Boil for 5 minutes. Filter. Add sufficient water to make the volume up to a litre.

5. Distribute in tubes. Sterilize at 115° C.

Liebig's broth.

1. Dissolve 5 grams of Liebig's extract of meat ["Lemco"] in 1000 grams of water, warming gently. Neutralize if necessary.

2. Autoclave for 5 minutes at 115°-117° C. Filter through a moistened paper in the warm.

3. Distribute in tubes. Sterilize at 110°-115° C.

Peptone (Chapoteaut) (10 grams) and salt (5 grams) may be added to the medium before neutralization.

In the same way a nutrient broth may be prepared with **Cibils' extract**. In that case 20 grams of the extract is used instead of the Liebig.

These media are used chiefly in German laboratories, [and the former to a large extent also in England].

Thymus broth (Brieger).

1. Obtain the thymus from two or three calves directly after they are slaughtered. Mince the glands finely and add an equal weight of distilled water.

Mix, and macerate for 12 hours.

2. Filter through muslin and squeeze out as much of the fluid as possible. Add an equal volume of water to the cloudy viscous filtrate.

3. Make feebly alkaline with a 10 per cent. solution of sodium carbonate.

4. Heat to 100° C. for 15 minutes in the autoclave or steamer (a higher temperature interferes with the properties of the medium).

Filter through a piece of fine linen.

5. Distribute in sterile tubes.

Sterilize at 100° C. for 15 minutes on each of two successive days.

Some micro-organisms, such as the cholera vibrio, will only grow satisfactorily on this medium provided that 5 or 6 times its volume of sterile water be added just before use.

Serum broth. Blood broth.

These media are prepared by adding to tubes of ordinary sterile broth, one-half, one-third or one-quarter their volume of blood-serum, ascitic fluid, or blood collected under aseptic precautions (p. 45 and Chap. XII.).

Achalme, in the preparation of blood broth, advises the use of a 1 per cent. solution of commercial hæmoglobin instead of blood. The hæmoglobin must first be sterilized by filtration through a Kitasato's filter (p. 25).

The preparation of these media will be more fully considered when dealing with the *Gonococcus* and Pfeiffer's *bacillus*.

On account of the difficulty of obtaining sterile blood, Bernstein and Epstein recommend the following procedure for the preparation of blood broth: collect 400 c.c. of ox blood in a flask containing 30 c.c. of a 1 per cent. solution of ammonium oxalate in distilled water and 0.5 c.c. of formalin; shake, and in half an hour dilute the mixture with 3 volumes of normal saline solution. After standing for a day or two at the temperature of the laboratory, distribute in agar or broth in the proportion of 1 part to 15 of medium. The formalin is thus so highly diluted that it does not interfere with the growth of micro-organisms. The *Pneumococcus*, *Gonococcus* and *Meningococcus* all grow very well in this medium.

Carbohydrate broths.

These media are prepared by adding to beef broth, at the same time as the peptone and salt, 2-4 per cent. of one or other of the following carbohydrates: glucose, saccharose, lactose, galactose, mannite, dulcitol, maltose, lævulose; the preparation is completed as in the case of broth.

[The use of carbohydrate media has been considerably extended in recent years in connexion with the identification and differentiation of the various members of the same group of micro-organisms, *e.g.* the differentiation of members of the typhoid-colon group, the differentiation of the streptococci, etc. (Gordon, Andrewes and Horder and others). For this purpose a medium differing somewhat from that given above, and having the following composition, is in general use.

| | | | | | | | | | |
|-----------------------------|---|---|---|---|---|---|---|---|-------------|
| Peptone. | - | - | - | - | - | - | - | - | 1-2 grams. |
| Water, | - | - | - | - | - | - | - | - | 100 c.c. |
| Test substance, | - | - | - | - | - | - | - | - | 1 gram. |
| Kahlbaum's litmus solution. | - | - | - | - | - | - | - | - | <i>Q.S.</i> |

[The test substance may be either a sugar, *e.g.* glucose, lactose, levulose, saccharose, etc.—an alcohol, *e.g.* mannite, dulcitol—or a glucoside, *e.g.* salicin, coniferin, etc.

[Care must be taken to obtain guaranteed pure chemicals from reliable firms, and an equal amount of care must be bestowed upon the sterilization of the media, since it is well known that in the presence of water and under the influence of heat many of these highly complex compounds undergo decomposition, often of the nature of an hydrolysis. Filtration through a porcelain filter would seem to be the best method of sterilization. After distribution into sterile tubes the latter must be incubated for a few days and those showing any change rejected.]

Glycerin broth.

Add 5 per cent. or 50 grams per litre of pure glycerin to peptone-beef-broth before distribution into tubes (Stage 7, p. 31).

Glycerin in the same proportion may also be added to the carbohydrate broths prepared as above.

Carbonated broth.

Add calcium carbonate (2 per cent.)¹ to lactose-, mannite-, glucose-, etc., broth before distributing into tubes (Stage 7, p. 31).

Calcium carbonate is most frequently added to lactose-broth. When an organism which ferments a given sugar is grown in a carbonated broth containing that sugar, the acids formed by decomposition of the carbohydrate act on the chalk with the formation of CO₂ and the evolution of a considerable quantity of gas.²

Milk.

Milk is used as a culture medium in several ways.

(A) Fresh milk, alkaline in reaction, is distributed in tubes (15-20 c.c. per tube).

The tubes are plugged with wool, and sterilized at 115° C. for 20 minutes.

This is the most simple method of preparation and suffices in the great majority of cases; it is the method ordinarily employed.

[In England it is usual to add sufficient litmus solution to tint the milk blue (p. 57), and to sterilize by steaming at 100° C. (Chap. I.). In our experience it is a very difficult matter to sterilize milk by steam at 100° C. in bulk; it is much safer to tube the milk and then sterilize it.]

(B) Since a temperature of 115° C. alters to some extent the properties of milk, it may be desirable for some purposes to sterilize at a lower temperature.

In that case, after washing the cow's udder with an antiseptic, the milker

¹ In our experience 0.5 per cent., or even 0.25 per cent. of calcium carbonate is sufficient.]

² It sometimes happens, however, that when an organism is grown in a litmus-sugar-carbonate-broth, acid is formed as shown by the change in colour of the litmus but no gas is evolved.]

should sterilize his hands and then collect the milk as it leaves the udder in sterile flasks. (For further details, see Chap. XII.)

Each flask is about three-parts filled, sealed in the flame, [or plugged with sterile wool and covered with an india-rubber cap,] and heated in a water bath at 60°–65° C. for eight days in the manner described on p. 12.

When sterilization is completed, the milk can be tubed into sterile tubes, as described in connexion with the preparation of serum (p. 45).

(C) If the technique of the milking process can be relied upon, it will be sufficient to fill as many tubes as are required, and to incubate them at 30° C. for some days before using the milk as a culture medium. In spite of every precaution some of the tubes will be contaminated, and any tube in which the milk has clotted or which on microscopical examination shows the presence of organisms must be rejected.

Urine.

Though urine was widely employed in the early days of bacteriology, it has now almost ceased to be used as a culture medium.

(a) 1. Boil some recently passed urine.

2. If the reaction be markedly alkaline after boiling, add a little tartaric acid solution, testing the reaction with litmus paper.

3. Filter, tube and sterilize at 115° C.

The composition of the urine is distinctly altered by this proceeding, the urea in solution being decomposed at the temperature of boiling water.

(b) It is better to sterilize by filtering through a Chamberland bougie (Chap. I.).

(c) To collect urine in a sterile manner, and so avoid the necessity for sterilization with the attendant alteration in composition, proceed as in Chap. XII. ("Urine").

The urine which has been collected in a flask may be tubed by any of the methods described for tubing serum (p. 45). Incubate the tubes at 37° C. for 48 hours, and reject any which are then cloudy.

Serum.

Serum is obtained by allowing blood to clot spontaneously or from the fluid of pleural effusions. It is used sometimes as a liquid but much more commonly as a solid medium after being coagulated by heat.

The technique for the collection of serum will be studied under the head of solid media (pp. 45 *et seq.*).

Blood.

Blood is frequently used as a culture medium.

To use it as a liquid medium coagulation must be prevented, and this may best be done by defibrinating the blood. The blood is collected aseptically (pp. 45 and 48 and Chap. XII.) in a sterile flask containing glass beads and shaken for about 10 minutes, then aspirated into a [Cobbett's bulb or] Chamberland flask (pp. 45 and 47) and tubed.

Among the many substances which it has been suggested might be added to blood to prevent coagulation, neutral sodium citrate and extract of leeches' heads may be mentioned.

By the sodium citrate method the blood is collected as it leaves the vein in a flask or tube containing a certain quantity of the following sterile solution: water, 1000 c.c.; sodium chloride, 8 grams; sodium citrate, 15 grams.

Extract of leech heads is obtained by placing the heads in 75 per cent. alcohol for 5 or 6 days. When hardened, the heads are dried and ground up in a mortar. The powder is dissolved in distilled water (100 c.c. per head), boiled, filtered and sterilized at 105° C. for 5 to 10 minutes. The extract is then introduced into the tubes in which the blood is to be collected.

These last two methods are not so good as defibrination.

2. Media made from vegetable tissues.

Vegetable infusions are but seldom used in practical bacteriology. The most important of them, however, may be mentioned.

Malt extract.

1. Grind up 100 grams of germinated barley (malt), and add 1000 grams of water.
2. Heat the mixture to 55°–58° C. for one hour: the starch is converted into maltose by the diastase and a true beer wort obtained; the temperature must not exceed 58° C., otherwise the diastase will be destroyed.
3. Boil. Filter through Chardin paper.
4. Tube. Sterilize at 115° C.

Yeast extract.

Mix 100 grams of yeast with 1000 grams of water. Boil and filter through Chardin paper.

Tube the slightly acid filtrate or pour it into a flask, and sterilize at 115° C.

The filtrate may be neutralized or made slightly alkaline by the careful addition of normal soda solution before filtering. The addition of 5 per cent. cane sugar or glucose before filtration increases the nutritive value of the extract. If the extract is not clear when filtered, a little phosphoric acid¹ may be added, and the reaction brought back with lime water. Heat to 116°–117° C. for 5 minutes. Filter. Tube. Sterilize at 115° C.

Spronck's peptone yeast extract.

1. To 5 litres of water add 1000 grams of commercial yeast (not brewers' yeast).
2. Boil the mixture for 20 minutes, stirring frequently, pour into cylindrical vessels and leave for 24 hours.
3. Decant the cloudy liquid and add 5 grams of salt and 10 grams of Witte's peptone for each litre.
4. Neutralize exactly, and then make alkaline to the extent of 7 c.c. of normal soda per litre. Boil. Filter through Chardin paper.²
5. Pour into flasks. Sterilize at 115°–120° C.

Hay infusion. Straw infusion.

Macerate 15–20 grams of finely chopped hay or straw in 1000 grams of water for 1 or 2 hours. Boil for a few minutes, filter, tube and sterilize at 115° C.

The infusion which is sometimes a little acid may be neutralized in the ordinary way.

Potato infusion.

Clean and scrape a few potatoes; add a litre of water to each 20–30 grams of pulp. Leave to stand for 3 or 4 hours. Decant. Boil the supernatant fluid. Filter. Tube. Sterilize. The infusion is often acid and can be neutralized before filtration.

Infusion of carrot is prepared in a similar manner.

Haricot decoction.

1. Macerate 50–60 grams of white haricot beans in a litre of water for several hours in the cold.

¹ Specific gravity 1.349, and containing 39.4 grams of anhydrous acid per cent.

² If the yeast contain meal the filtered liquid remains slightly cloudy, but this is of no consequence.

2. Boil for half an hour.
3. Pour on to a coarse sieve, collect the liquid, and add to it 1 per cent. salt, 2 per cent. ordinary sugar and a pinch of sodium bicarbonate. Boil. Filter through paper.

4. Tube. Sterilize at 115° C.

This medium is used by Mazé for the cultivation of the micro-organism found in the nodules of leguminous plants.

Decoction of dried fruits.

1. Macerate 50–100 grams of dried fruits (prunes or raisins) in a litre of water for several hours. Then stew them in the water.
2. Pass through a coarse sieve.
3. Boil. Filter.
4. Tube. Sterilize at 115° C.

The liquid is slightly acid and is useful for cultivating moulds. For other purposes neutralize with soda solution before boiling (Stage 3).

Wine.

Wine was much used by Pasteur in his early work, but is now hardly ever seen in the laboratory. Before sterilizing, neutralize or make slightly alkaline with soda solution in the ordinary way.

3. Synthetic media.

These media, though seldom used in everyday work, have been employed for the study of certain problems in the biology of micro-organisms.

The formulæ of the best known are given below. Some others will be described in connexion with the organisms in the study of which they have been employed.

Pasteur's medium.

| | |
|------------------------------|------------|
| Water, - - - - - | 100 grams. |
| Candied sugar, - - - - - | 10 " |
| Ammonium tartrate, - - - - - | 0.10 gram. |
| Ash of yeast, - - - - - | 0.075 " |

Boil. Filter. Tube. Sterilize. The reaction is alkaline.

Raulin's medium.

| | |
|--------------------------------|-------------|
| Water, - - - - - | 1500 grams. |
| Candied sugar, - - - - - | 70 " |
| Tartaric acid, - - - - - | 4 " |
| Ammonium nitrate, - - - - - | 4 " |
| Ammonium phosphate, - - - - - | 0.6 gram. |
| Potassium carbonate, - - - - - | 0.6 " |
| Magnesium carbonate, - - - - - | 0.4 " |
| Ammonium sulphate, - - - - - | 0.25 " |
| Zinc sulphate, - - - - - | 0.07 " |
| Sulphate of iron, - - - - - | 0.07 " |
| Potassium silicate, - - - - - | 0.07 " |

Prepare as in the case of Pasteur's medium.

The reaction is acid. This medium was used by Raulin in his well-known work on *Aspergillus niger*.

Cohn's medium.

| | |
|---------------------------------|------------|
| Distilled water, - - - - - | 200 grams. |
| Ammonium tartrate, - - - - - | 2 " |
| Potassium phosphate, - - - - - | 1 gram. |
| Magnesium sulphate, - - - - - | 1 " |
| Tricalcium phosphate, - - - - - | 0.10 " |

Prepare as in the case of Pasteur's medium. The reaction is alkaline.

Nægeli's medium.

| | | |
|--------------------------------|------|--------|
| Water, - - - - - | 1000 | grams. |
| Ammonium tartrate, - - - - - | 10 | " |
| Potassium phosphate, - - - - - | 1 | gram. |
| Magnesium sulphate, - - - - - | 0.2 | " |
| Calcium chloride, - - - - - | 0.12 | " |

Prepare as above.

Uschinsky's medium.

| | | |
|-----------------------------------|------|--------|
| Distilled water, - - - - - | 1000 | c.c. |
| Glycerin, - - - - - | 30 | grams. |
| Sodium chloride, - - - - - | 5 | " |
| Calcium chloride, - - - - - | 0.1 | gram. |
| Magnesium sulphate, - - - - - | 0.2 | " |
| Di-potassium phosphate, - - - - - | 2 | grams. |
| Ammonium lactate, - - - - - | 6 | " |
| Potassium aspartate, - - - - - | 3 | " |

The method of preparation is the same as in the other cases. This medium was used by Uschinsky in his work on diphtheria toxin.

SECTION II.—SOLID MEDIA.

The introduction of solid media into practical bacteriology is due to Schrøter and especially to Koch. The commonest are transparent media, prepared by adding to broth substances capable of making it solid at ordinary temperatures; but albumins coagulated by heat (serum, egg, etc.), meat and certain vegetable media are also used.

1. Gelatin media.

Gelatin media are in very general use, and several different sorts are prepared.

General rules.—1. Use extra quality French gelatin, which is sold in thin rectangular sheets weighing about 2.5 grams each. (*Ordinary commercial gelatin loses its property of solidifying if heated above 102°–105° C. and sterilization must therefore be effected at 100° C.; this introduces an unnecessary complication into the preparation of the medium.*)

2. Gelatin is very acid, and the medium must be neutralized after adding it to the other constituents, but the addition of alkali must be stopped at the neutral point or when the reaction is very slightly alkaline, because gelatin will not solidify after being heated in alkaline solution.

3. Ordinary gelatin media liquefy at 25° C., and can therefore only be used when the temperature of incubation is not to exceed 20°–23° C.

Ordinary gelatin.

This medium is generally known simply as **gelatin**.

Method recommended.—Proceed as in the preparation of broth.

1, 2 and 3. Macerate 500 grams of lean beef in a litre of water, heat, express the fluid, filter while hot and make up the volume to a litre.

4. To this broth add

| | | |
|----------------------------------|---------|------------------|
| Peptone (Chapoteaut), - - - - - | 10 | grams. |
| Salt, - - - - - | 5 | " |
| Sodium phosphate, - - - - - | a pinch | (not essential). |
| Extra quality gelatin, - - - - - | 80–150 | grams. |

The amount of gelatin required varies according to the time of year: in winter 8 per cent. (80 grams per litre) is sufficient, but in summer as much as 10 to 15 per cent. is necessary—say 120 grams per litre.

Warm the mixture at a gentle heat in an enamelled saucepan, stirring constantly to prevent the gelatin sticking to the bottom. When the gelatin is dissolved, boil for two or three minutes.

5. The medium is now very acid; add soda solution carefully, testing the reaction with litmus paper after each addition. The end reaction should be neutral or very slightly alkaline.

6. Autoclave for 5 minutes at 115° C. in a flask or enamelled vessel, to precipitate earthy phosphates.

7. On taking out of the autoclave pour the hot fluid on to a moistened Chardin paper fixed in a hot water funnel: the filtration must be done in the warm, otherwise the gelatin will solidify before it has filtered.

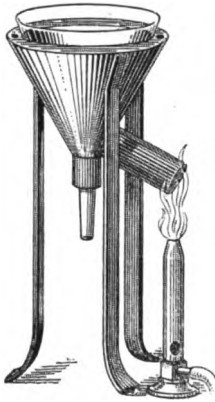

FIG. 32.—Hot water funnel.

A more simple method consists in filtering through a glass funnel fitted into a flat-bottomed flask, the flask and funnel being placed in the autoclave [or steamer], which is heated to 100° C. Filtration is quite easy under these conditions.

Hot water funnel.—This piece of apparatus consists of a copper funnel mounted on legs (fig. 32), and lined by a second—glass—funnel, the delivery tube of which, passing through the neck of the metal funnel, is made to fit it closely with an india-rubber bung. Pour water into the space between the two funnels through a small lateral opening provided for the purpose, and heat the apparatus by means of a Bunsen burner placed beneath a side tube projecting from the lower part of the metal funnel. The temperature should not be raised to boiling point, otherwise the water will be driven out through the inlet tube. Heat the funnel before pouring the gelatin on it. Several patterns of this apparatus are made; one useful form is that in which the metal funnel has two metal walls, and the glass funnel fits inside the inner wall.

8. Collect the filtered liquid in a flask and tube it at once—before it has had time to solidify—in quantities of 10–15 c.c. in each tube.

A small glass funnel should always be used for tubing to avoid soiling the mouth of the tubes, as has been already explained (p. 32).

The medium should be perfectly clear.

9. Plug the tubes: sterilize at 110° C. for 20 minutes, taking care that the temperature does not reach 115° C. [Sterilization may be effected equally by heating in the steamer to 100° C. for 20 minutes on each of three successive days.]

Notes.—(a) Gelatin prepared in this way is quite clear and absolutely transparent. If the liquid be slightly cloudy after filtering, add the white of an egg beaten up in 50 to 100 c.c. of water, mix thoroughly and autoclave for 5 minutes at 115° C.; then after filtering through Chardin paper the mixture is perfectly clear. It is advised that this method be employed as seldom as possible as it is not without influence on the melting point of the gelatin.

(b) The low temperature at which gelatin melts (23°–25° C.) being a disadvantage in the use of the medium, bacteriologists have attempted to raise the melting point by modifying the method of preparation. Many of these modifications seem to be of no practical value: the author has never found any advantage in using carbonate of soda for neutralization as recommended by Bertarelli, and similarly Roux's method of sterilization at 100° C. on several successive occasions appears uselessly to complicate the preparation of the medium without offering any corresponding advantage.

By following the instructions given above, and provided that (1) a good quality of gelatin be used, (2) neutralization be stopped at the neutral point or when the liquid is very slightly alkaline, and (3) a temperature of 115° C. be never exceeded, a 10 per cent. gelatin is easily obtained which does not melt below 25° C.; and

by raising the gelatin content to 15 per cent. the medium will remain solid at summer temperature.

An important point is to cool the tubes rapidly on taking them out of the autoclave, and to store them in a cold place as recommended by Abba.

Fischer's gelatin.

For the cultivation of phosphorescent bacteria Fischer recommends a gelatin very rich in sodium chloride. To a litre of meat extract prepared as above add

| | | | | | | | | |
|--------------------------|---|---|---|---|---|---|--------|--------|
| Peptone (Chapoteaut), | - | - | - | - | - | - | 10 | grams. |
| Salt, | - | - | - | - | - | - | 30 | " |
| Gelatin (extra quality), | - | - | - | - | - | - | 80-120 | " |

Dissolve, and proceed as in the preparation of ordinary gelatin.

Liebig's gelatin.

Dissolve 5 grams of Liebig's extract [Lemco] in 1000 grams of water (add if necessary 10 grams of peptone, and 5 grams of salt), then add 100 grams of gelatin, dissolve, and boil for 2 or 3 minutes. Neutralize and complete the preparation as for ordinary gelatin.

Buchner's gelatin.

1. Dissolve with heat in a litre of water

| | | | | | | | | |
|---------------------------|---|---|---|---|---|---|-----|--------|
| Gelatin (extra quality), | - | - | - | - | - | - | 100 | grams. |
| Cane sugar, | - | - | - | - | - | - | 20 | " |
| Liebig's extract [Lemco], | - | - | - | - | - | - | 5 | " |
| Dry peptone, | - | - | - | - | - | - | 5 | " |

2. To the solution add

| | | | | | | | | |
|-----------------------|---|---|---|---|---|---|---|--------|
| Tricalcium phosphate, | - | - | - | - | - | - | 5 | grams. |
|-----------------------|---|---|---|---|---|---|---|--------|

3. Boil for a few minutes, heat to 115° C., filter and proceed in the ordinary way.

Raisin gelatin.

1. Make a decoction as described on p. 38, consisting of 250 grams of dried raisins in a litre of water.

2. Filter, then add 100 grams of gelatin and a pinch of sodium phosphate. Boil for 2 or 3 minutes. Neutralize and finish as usual.

Elsner's potato medium

1. Take 500 grams of potatoes, peel and grate them.
2. Macerate the pulp in a litre of water for 3 or 4 hours.
3. Strain. Stand overnight. Decant the fluid.
4. Make up the volume of fluid to a litre, and dissolve in it with gentle heat 15 to 20 per cent. (150 to 200 grams) of gelatin. Boil for a few minutes.
5. The fluid is now very acid. Add normal soda solution until the reaction is feebly but still *distinctly acid*.
6. Heat to 115° C. for 5 minutes. Filter and complete the preparation in the ordinary way.

Choquet's gelatin.

Choquet recommends the two following media for the cultivation of the micro-organisms concerned in dental caries.

| | | | | | | | | |
|--------------------------------|---|---|---|---|---|---|-----|--------|
| 1. Meat extract, | - | - | - | - | - | - | 500 | c.c. |
| Gelatin (extra quality white), | - | - | - | - | - | - | 35 | grams. |
| Peptone (Chapoteaut), | - | - | - | - | - | - | 5 | " |
| Calcium glycono-phosphate, | - | - | - | - | - | - | 5 | " |

| | | | | | | | | |
|----------------------|---|---|---|---|---|---|---|----------|
| 2. Meat extract, | - | - | - | - | - | - | - | 500 c.c. |
| Peptone, | - | - | - | - | - | - | - | 5 grams. |
| Gelatin, | - | - | - | - | - | - | - | 35 " |
| Calcium phosphate, | - | - | - | - | - | - | - | 50 " |
| Magnesium phosphate, | - | - | - | - | - | - | - | 5 " |
| Calcium carbonate, | - | - | - | - | - | - | - | 10 " |

Dissolve the gelatin and peptone in the meat extract: heat in the autoclave and filter in the ordinary way. After filtration and before distributing in tubes add the calcium and magnesium salts.

2. Agar media.

Agar-agar is derived from a sea-weed growing in the Indian Ocean, and in commerce occurs as dried fibrous strands.

When agar is boiled with water it forms a firm jelly which does not melt below 90° C. Agar is therefore substituted for gelatin whenever a solid medium is required for incubation above 25° C.

The preparation of agar media is tedious because agar readily forms with water a thick jelly which is difficult to filter. This difficulty is overcome by altering the properties of the agar by prolonged boiling or by chemical action, *e.g.* the addition of acid.

Another difficulty arises from the fact that agar is always cloudy if not cleared with albumen, and even then it is sometimes opalescent.

Ordinary Agar.

An agar medium prepared according to the method now to be described is generally spoken of as **agar**, and the word will be so used in this book.

Preparation of Agar.

[A. Method recommended.—1. Weigh out 30 grams of agar fibre, turn it into a 2-litre flask and fill the flask nearly full of tap water, then add 10 c.c. of a 2 per cent. solution of acetic acid and stir well with a glass rod.

[2. Leave the agar to soak for 10 minutes, then put a large funnel into the flask, stand the funnel under the cold water tap and wash the agar in running water until the washings are neutral to litmus paper (10 minutes).

[3. While preparing the agar, stand a flask containing a litre of broth in the steamer and heat to 100° C.

[4. Add the washed agar to the hot broth.

[5. Heat the mixture in the steamer at 100° C. until the agar is dissolved (20 minutes).

[6. The medium is now a little acid. Neutralize with a 10 per cent. solution of caustic soda (about 1 c.c.) and allow the contents of the flask to cool to 50°–60° C.

[7. Beat up the white of two eggs in a beaker, and add to the cooled agar. Mix thoroughly.

[8. Heat the mixture in the steamer at 100° C. until the egg-albumin is coagulated, and until on holding up the flask to the light the agar is clear ($\frac{3}{4}$ –1 hour). At the same time put into the steamer a Chardin filter paper arranged in a funnel, the latter standing in a sterile flask.

[9. When the medium is clear—there will nearly always be lumps of coagulated albumin floating about in the agar—pour it on to the hot filter in the steamer. The filter must not be taken out of the steamer, and the medium should be poured down the sides of the filter paper.

[10. Place the lid on the steamer, and maintain the heat until the medium has all filtered through (15 minutes).

[11. Tube, and sterilize for 30 minutes at 100° C. on two successive days. Slope (see B. 9 *infra*).

[This method always gives a perfectly clear, transparent and very slightly opalescent medium. The yield is very approximately 100 per cent.—that is to say that from a litre of broth rather more than a litre of agar is obtained. No trouble is ever experienced in getting the agar to adhere to the walls of the tubes.

[If the autoclave be used the medium is generally of a brownish colour from over-heating, and it is sometimes difficult to get the medium to stand up in the tubes.]

B. Another method, which is also recommended, is as follows :

1. Prepare a peptone-beef-broth, according to the instructions given on p. 30, up to and including Stage 5.

2. To this broth add 20 grams (2 per cent.) of agar cut up into small pieces. The agar should be swollen by soaking in cold water for an hour or two, and then wrung out in a cloth before being added to the broth.

3. Heat the mixture to 100° C. in an enamelled saucepan, and keep it at this temperature until the agar is dissolved (about half an hour), stirring all the time.

4. Test the reaction, which should be neutral or faintly alkaline. If heated in presence of acid, agar becomes converted into sugar.

5. Cool to 55° or 60° C. and add the white of an egg beaten up in 100 grams of water. Mix thoroughly.

6. Autoclave for an hour at 120° C. The albumin is coagulated and carries down the impurities with it.

7. Pour the liquid while still hot on to a moistened Chardin paper arranged in a hot water funnel. Cover the funnel with a glass plate.

8. Collect the liquid as it filters in a previously sterilized flask, and tube at once. This must be done as quickly as possible as agar sets about 40° C., and a funnel as usual should be used in tubing it to prevent the medium soiling the mouths of the tubes. Each tube should contain 8 to 10 c.c.

9. Sterilize at 115° C. for 20 minutes. After sterilization and while the medium is still hot, slope the tubes on some such piece of apparatus as that pictured on p. 52, so that the agar solidifies with a sloped surface. Leave the tubes in this position for 36 hours.

Some bacteriologists recommend the addition of a small quantity of an aqueous solution of gum arabic to the agar, to prevent the thin upper part becoming detached from the wall of the tube when it is placed vertically. But gum arabic makes the medium distinctly cloudy, and does not appear to effect the purpose for which it is added.

If the method of preparation described be followed step by step, the agar will be found to adhere sufficiently well. Gelatin to the amount of 20 grams per litre may be added as recommended by Nicolle.

Modification.—Filtration may be accomplished in the following manner, even more easily than by the above method.

Before adding the agar to the broth (Stage 2) leave it to soak in 6 per cent. hydrochloric acid (water, 500 : HCl, 30) for 24 hours, and wash in a large quantity of water. Then soak in a 5 per cent. solution of ammonia (water, 500 : ammonia, 25) for some hours, wash in a large quantity of water, and squeeze the agar dry in a cloth. The agar is now ready to add to the broth, and the further steps are as described. The resulting jelly does not adhere well to the walls of the tubes, and the process cannot be recommended.

Karlinski's filter.—To facilitate filtration, Karlinski has devised an apparatus in which the agar is filtered under pressure. A water-jacketed copper vessel heated below by a ring Bunsen is fitted with a copper cylinder, the bottom of which shaped like a funnel and terminating in a delivery tube fitted with a tap is covered with a layer of absorbent wool. The agar is poured on to the wool, and the upper opening is hermetically sealed by means of a cover through which the tube of an india-rubber syringe passes. When the ball of the syringe is squeezed, the air in the apparatus above the agar is compressed and forces the agar through the wool. This ingenious piece of apparatus does not appear essential because if the agar be prepared in either of the ways described no difficulty will be experienced in filtering through Chardin paper.

Fischer's method.—Fischer proposes to overcome the difficulty of filtration as follows. Plug the narrow end of a funnel with an ordinary cork, and pour the agar into the funnel at once on taking it out of the autoclave. Allow to cool. The solid particles which cause the cloudiness settle to the bottom of the funnel. When the agar is set the jelly is turned out whole and the opaque conical part cut off with a knife. Cut up the remainder into small pieces and put into tubes. Plug and sterilize the tubes. The resulting agar is always opaque.

Malm's Agar.

Add 2 per cent. of agar to Liebig's or Cibils' broth (p. 34). Proceed as for ordinary agar.

Peptone-agar (Salomonsen).

1. Make a broth with

| | |
|-----------------------------|-------------|
| Water, - - - - - | 1000 grams. |
| Liebig's extract, - - - - - | 5 " |
| Peptone, - - - - - | 30 " |
| Cane sugar, - - - - - | 5 " |

If necessary add a little alkali.

2. Dissolve 15 grams of agar in the broth, and proceed as above.

Glycerin-agar.

Add 2 per cent. of agar to glycerin broth (p. 35), and proceed in the ordinary way.

Glucose-glycerin-agar.

Prepare a glucose broth (p. 34), and after neutralization add 5 per cent. neutral glycerin and 2 per cent. agar. Complete the preparation in the usual manner.

Gelatin-agar.

By mixing agar and gelatin a medium is obtained the melting point of which lies between that of agar and that of gelatin. In warm climates, in the summer, agar-gelatin may be used in place of gelatin. But it must be borne in mind that the cultural characteristics of micro-organisms are far from being identical on the two media. Gelatin-agar is prepared as follows.

1. To 1000 grams of peptone-broth, add

| | |
|--------------------|-----------|
| Gelatin, - - - - - | 80 grams. |
| Agar, - - - - - | 5 " |

or

| | |
|--------------------|-----------|
| Gelatin, - - - - - | 50 grams. |
| Agar, - - - - - | 8 " |

Dissolve the gelatin in the broth, neutralize, and then add the agar.

2. Complete the preparation as in the case of ordinary agar, but at Stage 5 do not let the temperature exceed 115° C.

Iceland moss.

Some workers use Iceland moss (*Lichen crispus*) in place of agar, but this substitution cannot be recommended.

3. Media made from albuminous fluids and tissues.

Serum.

Serum is the liquid which separates when blood has clotted. In bacteriology bovine, sheep and horse serum are principally used. Serum is most frequently used after coagulation by heat, very rarely in the liquid condition.

An important point about serum media is that they should be almost transparent, hence they cannot be heated to a high temperature because they coagulate *en masse* and become opaque. Liquid serum ought not to be heated above 56° or 58° C., and to preserve its transparency solidified serum should be coagulated at about 70° C.

Serum cannot therefore be sterilized in the ordinary way.

Either (a) it must be sterilized by pasteurization combined with tyndallization (Koch's method) or by filtration through a bougie: or (b) since the blood in the body is sterile, a sterile medium can be obtained if care be taken to avoid introducing contaminations while collecting the blood and drawing off the serum (Roux and Nocard's method).

Collection of serum.

1. In the slaughter-house.

[A. Method recommended.—When the blood is collected in the slaughter-house, the following is a simple method of proceeding.

[1. When the carotid is severed discard the first spurt of blood, then take the plug out of a sterile 2-litre flask and hold it so that the blood pours into the open mouth: collect enough blood to three-parts fill the flask: replace the plug. Collect as many flasks of blood as are required.

[2. On reaching the laboratory place the flask on a cork ring, inclining it as much as possible. Take out the wool plug, burn the mouth of the flask with a Bunsen burner both inside and outside and plug the flask at once with clean wool ready sterilized and wrapped in paper. Then stand the flask vertically, shaking it as little as possible.

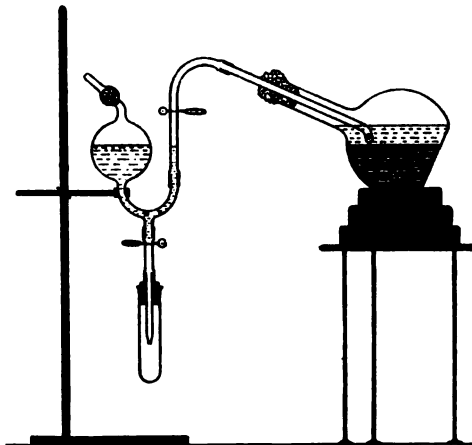

FIG. 33.—Cobbett's bulb as used for decanting serum.

[3. When the clot has formed and the serum separated, tilt the flask again—the clot should adhere to the bottom—and introduce a piece of glass tubing connected to a Cobbett's bulb (fig. 33).

[The glass tubing is a piece of ordinary-sized glass tubing bent near the end into an obtuse angle and sealed. About half a centimetre from the sealed end a small hole is blown into it through which the serum enters. This is connected with the Cobbett's bulb by a fairly long piece of india-rubber tubing.]

[4. By aspirating through the plugged tubulure the serum can be drawn into the bulb. When the bulb is nearly full, clip the tubing between the flask and the bulb.

[5. Remove the test-tube enclosing the delivery-tube, and by releasing the clip above it draw off the serum into test-tubes.

[6. Coagulate the serum (p. 51).

[7. Incubate the tubes for 48 hours and reject those which show any growth.]

[For many purposes, *e.g.* the cultivation of the diphtheria bacillus, the serum may be further sterilized after coagulation by heating it to 100° C. in the steamer (Chap. I.).

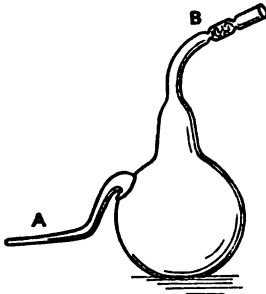

FIG. 34.—Chamberland distributing flask.

[If the serum be wanted in the liquid form for future use, it is best to distribute it in small quantities into tubes, to heat it to 55°–60° C. in the water

bath for some time, and then to add a drop or two of chloroform to each tube with a sterile pipette. The chloroform is readily driven off subsequently by heating the tubes to 40–45° C.]

B. Koch's method. Apparatus required.—Prepare beforehand :

1. Three or four large covered glass dishes each consisting of two halves fitting one into the other, and capable of holding 2 litres.

Wrap the dishes in paper and sterilize them in the hot air sterilizer at 180° C. The temperature must be raised slowly to avoid cracking the glass.

2. Chamberland distributing flasks (fig. 34).

Wash and dry the flasks, carefully seal the pointed tubulure A in the flame, plug the other tubulure B with wool between the constrictions, and sterilize at 180° C.

3. Half-litre flasks with long necks (fig. 35). Plug and sterilize at 180° C.

4. Sterile plugged test-tubes.

Technique.—1. Collect the blood at the slaughter-house, preferably in cool weather, in the sterilized glass dishes. To collect the blood remove the dishes from their paper wrappings, and when the beast is being bled, after letting the blood which first issues flow away, raise the cover of one of them and collect enough blood to fill it three-parts full: then replace the cover. Several dishes should be filled in the same way.

2. Put the dishes containing the blood in a cool place, but not in the ice chest, because hæmolysis may occur and so impart a red colour to the serum.

3. After about 36 hours the clot will have formed and shrunk leaving the serum as a clear fluid on top. Break off the fine point of a Chamberland flask (fig. 34), pass it through the flame of a spirit lamp and avoiding all sources of contamination as far as possible aspirate the serum into the flask. Seal the point in the flame.

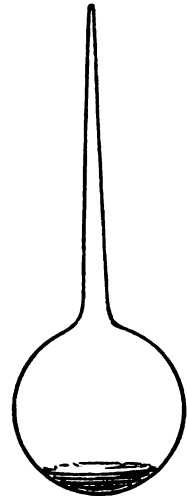

FIG. 35.—Flask with neck drawn out and sealed.

Modification recommended.—A better yield of serum is obtained if instead of collecting the blood in glass dishes Latapie's apparatus be used (p. 50). For the present purpose the tube *a* (fig. 40) is replaced by a sterile funnel by means of which the blood is collected as it spurts from the severed vessel. When the bottle is half-filled, the funnel is taken out and an india-rubber plug put in its place. The further steps are described at p. 50.

The serum is sterilized in the following manner :

4. Take the Chamberland flasks containing the serum to the laboratory. In spite of the precautions taken the serum will be certain to be more or less contaminated, and must therefore be sterilized. Distribute it first into flasks with long necks thus : flame the mouth of the flask in a Bunsen burner and remove the cotton-wool plug : break off the capillary point of the tubulure on the Chamberland flask, pass the broken end through the flame, and introduce it some distance into the neck of the other flask ; then by blowing through the tube B the serum can be transferred to the other flask. Meanwhile the wool plug of this flask is held between the thumb and index finger of the left hand.

5. The flask being about three-parts filled, its wool plug is removed and the neck heated in the blow-pipe and sealed a few centimetres from the bulb. As many flasks are used as are necessary to contain the serum collected.

6. The flasks after filling and sealing are heated in a water bath, as already described (p. 12), to 56° or 58° C. for one hour on eight consecutive days.

7. When sterilized the serum has to be distributed. A mark is made on the neck of the flask with a glass cutter near the sealed end and to this scratch the end of a very hot glass rod is applied : this cracks the glass and the crack is extended by touching the end of it with the heated glass rod. The two ends of the fracture soon join, and with a gentle tap the end of the neck which was sealed in the flame can be easily separated and the flask opened.

Place the flask B on a cork ring E so that the neck is as nearly horizontal as possible.

Flame the pointed tubulure of a sterile Chamberland flask A in a Bunsen, break off the end with sterile forceps and insert the tube into the flask so as to almost touch the clot D, and aspirate the serum C. Discard the top layer of serum because having been in contact with the air, it may possibly be contaminated by dust (fig. 36).

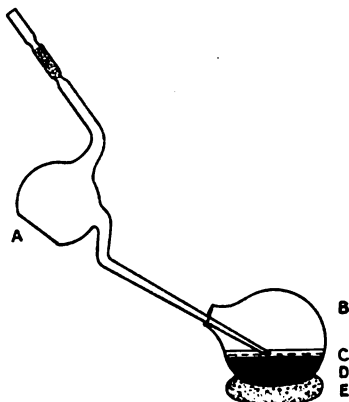

FIG. 36.—Distribution of serum.

8. By means of the Chamberland flask, distribute the serum in sterile tubes, passing the mouth of each tube rapidly through the flame before taking out the wool plug, and flaming also the pointed tubulure of the Chamberland. Pass the tapering end well into the test-tube, and pour about 10 c.c. into each. Replace the plug in the tube.

The serum is now ready either for coagulation or for use in the liquid state (in the latter case it should be first incubated for 48 hours at 30° C.).

If the serum is to be set this should be done as soon as possible, for should any organisms have gained access to the tubes during filling, the heat of coagulation will very probably destroy them.

Note.—The serum may be sterilized by filtration instead of by heat ; but filtration of serum is a long and tedious operation, and usually a troublesome one, as the

serum froths considerably as it comes through the bougie. If filtration be decided upon, a Berkefeld bougie through which the serum passes much more readily than through the finer Chamberland F type should be used. The technique is described at pp. 18 *et seq.*

To facilitate the filtration of serum Miquel has devised an apparatus which works at 40° C. The serum is poured into a cylindrical vessel containing a filtering bougie. The cylinder with its contained bougie is placed in a double-walled vessel heated below by a gas burner on which a regulator is placed. The bougie is connected by means of india-rubber tubing to a conical flask with a tubulure attached to a water pump. Before use the flask is sterilized in the hot air sterilizer and the bougie and rubber connexions in the autoclave. The side tube of the flask should be plugged with wool.

2. From a living animal.

[**A. Method recommended.**—When a living animal—horse or bovine—is available, the technique will be as follows.

[1. Take three or four large (2–3-litre) sterile Jena flasks.

[2. Prepare a trocar—Sivori's pattern (fig. 38, p. 49) is very suitable—thus: to the side tube attach a fairly long piece of india-rubber tubing, and to the other end of the latter connect a piece of straight glass tubing long enough to reach from the mouth to the bottom of the flask. Boil the apparatus for an hour.

[3. Take the trocar out of the water with a pair of sterile forceps, pass it between the neck and the plug of one of the sterile flasks, and then wrap the plug well round it. Pass the glass tube well down into the flask in the same way.

[4. Cleanse the skin of the neck of the animal, and pass the trocar into the jugular vein as described at p. 49.

[5. When the flask is about two-thirds filled, pinch the rubber tubing, get an assistant to withdraw the glass tubing and pass it as in (3) into a second flask. Release the pressure on the tubing, and fill the second, and in the same way the third and fourth flasks. Care must be taken when withdrawing the trocar in the first instance, and the glass tube later, that the wool plug is so arranged that no air channel is left.

[6. Take the flasks of blood to the laboratory and stand them vertically. If any of the plugs be soiled with blood or do not fit well replace them with sterile wool (see A. 2 p. 45).

[7. When the clot has formed and the serum separated, proceed as in A p. 45.

[8. The serum should be sterile, but as a precautionary measure a little chloroform may be added to it or it may be heated to 55°–60° C. for an hour.]

B. Roux and Nocard's method. Recommended.—This method has the advantage of furnishing a much clearer serum and a medium more favourable

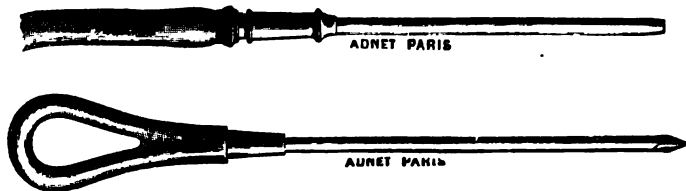

FIG. 37.—Nocard's trocar.

for growth than Koch's, and should therefore be adopted in preference to the latter whenever possible.

Instruments required.—1. A Nocard's trocar (fig. 37) on to the cannula of

which, when the trocar is withdrawn, a metal adjustment can be fitted; this carries a piece of red rubber tubing about 50 cm. long, to which is attached a piece of glass tubing 15 cm. long bevelled at its free end.

The trocar and the rubber tube with its appendices are wrapped separately in filter paper and autoclaved.

Sivori's trocar (fig. 38) may with advantage be employed instead of Nocard's; it is provided with a lateral tube E to which the rubber tubing is attached. The trocar with tubing attached can be sterilized as a single piece of apparatus, and the blood collected directly, thus avoiding any risk of contamination.

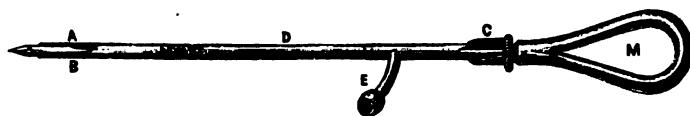

FIG. 38.—Sivori's trocar.

M, handle; C, shoulder into which the conical part AB fits hermetically, so that the blood flows up the cannula D, and passes out through E.

2. A pair of sterile scissors curved on the flat and a sterile bistoury.

3. One or two wide-mouthed bottles of 3 litres capacity.

The bottles are washed and dried, and the mouth of each covered with two or three folds of paper which is tied down round the neck with string; over this another similar but larger covering is fastened with string in a similar manner, so that it can be removed without interfering with the cover beneath (fig. 39). The bottles must be sterilized in the hot air sterilizer.

4. Some sterile Chamberland flasks and test-tubes.

Technique.—As a rule, blood is taken from an horse or an ass while the animal is standing. If necessary its eyes can be covered and the animal can be held with a twitch. If it is proposed to bleed a bovine animal, it will be best to throw it on a table such as is used for vaccination inoculations.¹ The animal, whichever species is used, should be fasting.

1. Proceed as for bleeding from the jugular vein. Sterilize the skin. Press the vein at the root of the neck to render it prominent, and make a small longitudinal incision through the skin with a bistoury along the line of the vessel on the distal side of the point of compression.

2. Introduce the trocar through the incision and push it through the sub-cutaneous tissues for a distance of about 2 cm., then pierce the vein and push the trocar into it in the direction of its long axis.

3. The cannula is now in place; withdraw the trocar, and attach the metal adjustment carrying the rubber tube. Meanwhile an assistant compresses the vein above to prevent blood entering the cannula. This must be done quickly.

4. The rubber tube being attached, pinch it firmly between the thumb and index finger of the left hand. The assistant releases the pressure on the vein above the cannula, but maintains the pressure on the cardiac side.

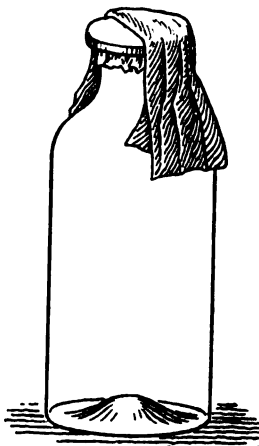

FIG. 39. - Bottle for collecting blood. Part of the outer cover has been removed to show the one beneath.

[¹In our experience it has never been necessary to throw a bovine animal: adults usually stand quite quietly.]

5. A second assistant hands the sterile bottle, loosens and removes the outer covering, and perforates the inner cover with the glass tube attached to the rubber tube. Now release the pressure on the rubber tubing, and blood will flow into the bottle.

When the first bottle is three-parts filled, stop the flow of blood by pinching the rubber tubing; the assistant then withdraws the glass tubing from the bottle and covers the mouth as quickly as possible with the paper cap and fastens it round the neck. Fill a second bottle in the same way.

5 to 6 litres of blood can be taken from an horse without harm, but 3 litres is sufficient to take from a young heifer.

6. Place the bottles in a cool place for 36 hours. The serum, which is transparent and of a beautiful pale yellow colour, will then be floating on the surface. Decant the serum from the clot with a Chamberland flask [or Cobbett's bulb], being careful not to contaminate it, and distribute it at once in sterile tubes as described above (pp. 45 and 47).

C. Latapie's apparatus. Recommended.—The technique of Roux and Nocard's method is simplified by using this apparatus. All contamination is avoided, and a yield of about 700 c.c. of serum per litre of blood is obtained instead of 400–450 c.c. by the ordinary method.

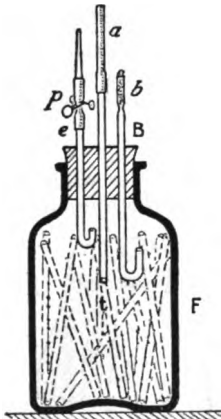

FIG. 40.—Latapie's apparatus, in which to collect blood for serum from large animals (horse or bovine).

Description.—The apparatus (fig. 40) consists of a wide-mouthed bottle *F* capable of holding several litres, and plugged with an india-rubber plug *B* perforated with three holes. A number of glass tubes (*t*) open at both ends and perforated with several holes laterally, is put into the bottle. Three pieces of glass tubing are passed through the india-rubber plug. Through one (*a*) the blood enters the bottle, a piece of rubber tubing connecting it with the cannula. The tube *b* is simply to allow access of air to the interior; it is plugged above with wool, while the other end extends some distance into the bottle and is bent in the form of an U. Lastly, the tube *e* serves for the collection of the serum: its lower end also bent in an U-shape reaches a few cm. below the plug, while its upper end is attached by means of a piece of rubber tubing to a piece of glass tube drawn out and sealed in the flame. A clip can be placed on the rubber connexion *p* to disconnect the two pieces of glass tubing. Finally, the apparatus is arranged in a special support (not pictured in the figure) which allows the bottle to be inclined so that the neck points upwards or downwards at will.¹

Technique.—1. Sterilize the apparatus in the autoclave. Moisten the wool in the tube *b*, wrap the bottle in filter paper, and raise the temperature slowly. After sterilization allow to cool, and then lute the plug with paraffin.

2. Puncture the vein as in Roux and Nocard's method, and connect the cannula to the tube *a*. The bottle must not be more than half-filled and the blood must not reach to the level of the air tube *b*. The flow of blood is stopped by clipping the tube *a*. (The bottle is of course held with the neck up during this part of the operation.)

3. Leave for 12 hours or more until the blood has clotted.

¹ In Chapter XII. an apparatus, designed by the same observer, for the collection of blood from small animals will be described.

4. When the clot has formed and shrunk from the pieces of glass tubing, invert the bottle gently in its support so that the neck is the lowest part. The serum will then run down into the neck.

5. Clip the tubing at *p*, break off the pointed end of the glass tubing, and plunge it into the sterile flask in which the serum is to be collected: loosen the clip, and the serum will flow out. By means of the clip the rate of flow can be altered at will or entirely stopped.

The opening of *e* within the bottle being a little distance from the plug, a small quantity of serum containing red cells remains in the bottle; the bend in the tube prevents these cells from being drawn off with the serum.

Coagulation of serum.

Serum is coagulated by heat. In order that it may retain its transparency, the temperature during coagulation must not exceed 68° – 70° C., and to completely solidify the serum it must be kept at this temperature for 2 or 3 hours.

The tubes containing the liquid serum are sloped as in the case of agar. Coagulation is generally effected in a modified form of the apparatus devised by Koch [e.g. in an Hearson's serum coagulator.]

[Hearson's serum coagulator.—In construction and in some models in appearance Hearson's serum coagulator (fig. 41) is the same as Hearson's

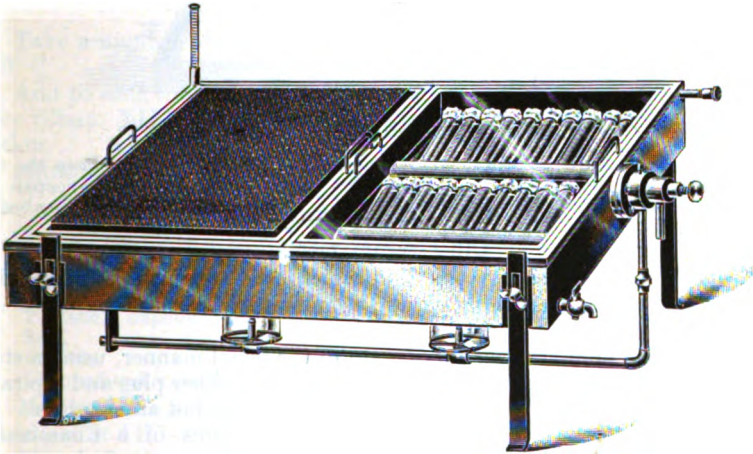

FIG. 41.—Hearson's apparatus for the coagulation of serum.

warm (37° C.) incubator (p. 61), but in the former the capsule is constructed to work at higher temperatures such as are suitable for the coagulation of serum. Special holders are also supplied which retain the tubes in a slanting position. To maintain a saturated atmosphere, dishes of water or wet cloths can be placed on the floor of the coagulator.]

Koch's apparatus consists of a double-walled rectangular copper box supported on legs, by means of which the angle which it subtends with the horizon can be altered at will. The space between the walls is filled with water, and the floor of the apparatus is covered with a thin layer of sand on which the tubes are laid. A thermometer is placed alongside the tubes. The apparatus is closed above with a moveable cover consisting of two sheets of glass mounted in a metal frame with a thin layer of air between them. The apparatus is heated by gas, which passes through a Roux's regulator immersed in the water between the two walls. The technique is as follows:

1. Lay the tubes, each containing about 10 c.c. of serum, in the sand. Incline the apparatus so that the serum does not touch the plugs.

2. Light the gas, and when the temperature as shown by the thermometer inside reaches 68° C., adjust the regulator (Chap. III.), so that the temperature remains constant.

3. The length of time required to solidify different samples of serum varies (from 2 to 3 hours). A tube must be taken out from time to time to ascertain the condition of the serum, which will be sufficiently set when holding the tube upright it retains its slope. [It is perhaps better to hold the tube by the upper end and tap the lower end firmly against the thumb nail: if the serum quiver, the heating has not been continued long enough.] Stop the heating at this stage. The serum when set should still be transparent and of an amber-yellow colour.

To obtain a more transparent product, Vagedes advises coagulating in an atmosphere of water vapour, and this can be effected by placing Petri dishes filled with water alongside the tubes, [or by placing folded cloths which have been wrung out in warm water over the tubes, taking care that they do not touch the wool plugs.]

4. Incubate at 30° [or 37°] C. for 36 hours, to ensure their sterility before using them as culture media.

If only a few tubes of serum have to be coagulated, Koch's apparatus can be dispensed with, and the tubes dealt with as follows. Arrange the tubes in a small flat copper tray (fig. 42), about 12 cm. wide, one side of which is notched to receive the upper plugged

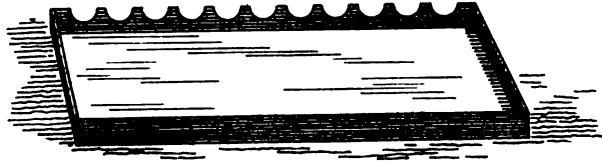

FIG 42.—Copper tray on which to slope tubes of culture media.

ends of the tubes, while the other ends resting against the opposite side keep the tubes in a sloped position. Cover the tray with a sheet of glass, stand it on a saucepan filled with water, and slowly heat the water to boiling. The tubes will be set in about an hour or two.

Other serum media.

In cases of simple pleurisy the fluid which can be drawn off often yields a very clear, easily coagulable serum, very suitable for the purposes of a culture medium.

To collect the fluid aseptically, operate in the usual manner, using a sterile Potain's apparatus. Boil the trocar, autoclave the rubber plug and aspirating tube at 115° C., and sterilize the flask [or bottle] in the hot air sterilizer. The serum is distributed into tubes afterwards by means of a Chamberland flask (see also p. 45). An absolutely sterile serum can frequently be obtained in this way, but it is nevertheless often necessary to tyndallize the fluid before coagulating it (p. 47).

Ascitic fluid as a rule yields only a poorly coagulable serum, which is not of great value when a solid serum is wanted.

Löffler's serum.

1. Prepare a broth in the ordinary way, using

| | | | | | | | | |
|-------------------------|---|---|---|---|---|---|------|----------------------------|
| Water, - | - | - | - | - | - | - | 1000 | grams. |
| Beef, - | - | - | - | - | - | - | 500 | " |
| Peptone, - | - | - | - | - | - | - | 20 | " |
| Salt, - | - | - | - | - | - | - | 5 | " |
| Glucose, - | - | - | - | - | - | - | 10 | " |
| Normal soda solution, - | - | - | - | - | - | - | Q.S. | to make slightly alkaline. |

2. Aspirate 1 part of this broth and 3 parts of sterile liquid serum into a Chamberland flask.

[The quantities can, of course, be measured out with sterile pipettes into a sterile vessel.]

3. Tube. Coagulate at 70°–75° C.

Glycerin-serum.

An excellent culture medium for the tubercle bacillus is obtained by mixing 6 to 8 per cent. of pure glycerin with serum.

1. Aspirate 6 to 8 grams of pure glycerin, previously sterilized in the autoclave, into a Chamberland flask:

2. Then 100 c.c. of sterile liquid serum into the same flask. (To facilitate measurement the flask can be graduated beforehand.)

3. Tube and set at 75° C. This mixture requires a somewhat higher temperature than ordinary serum.

Serum-agar. Ascitic-agar.

1. Dissolve 1.5 grams of agar in 100 c.c. of water. Filter. Tube (about 5 c.c. in each tube). Sterilize at 120° C.

2. Cool to 40° C. To each tube add an equal volume of sterile serum or sterile ascitic fluid. Mix gently by rotating the tubes in the hands. Cool in the sloping position.

Blood-agar.¹

(*Bezançon and Griffon.*)

1. Take a number of tubes of glycerin-agar, melt in a water bath, and cool to 40° C.

2. Add to each tube a small quantity (about 1 c.c.) of blood from a rabbit's artery (Chap. XII.). Mix without shaking the tubes, and cool in a sloping position.

A solution of hæmoglobin (p. 34) may be used instead of blood in this case.

Serum-agar.

(*Tochtermann.*)

1. Dissolve in 500 c.c. of boiling water

| | | | | | |
|---------------------------------|---|---|---|---|----------|
| Peptone (Chapoteaut, or Witte), | - | - | - | - | 5 grams. |
| Salt, | - | - | - | - | 2.50 " |
| Glucose, | - | - | - | - | 2.50 " |
| Chopped and washed agar, | - | - | - | - | 10 " |

2. Mix with the above solution 500 c.c. of sheep serum, and autoclave for 30 minutes at 115°–120° C.

3. Filter in the warm through moistened Chardin paper. Tube and sterilize at 115° C.

Egg.

Eggs can be used for the cultivation of micro-organisms in several ways.

A. Take a fresh egg, shake it vigorously to mix the white and the yolk: wash the shell in perchloride of mercury and dry with sterile filter paper. Flame the narrow end until the shell blackens. Make a hole with a sterile metal point. Pass a platinum wire or pipette charged with the material to be sown through the hole, then close the latter with a little melted Golaz's wax. It is well to coat the egg with a layer of collodion.

B. Take a fresh egg, flame the pointed end, make a hole as described above: aspirate the white into a sterile pipette. Tube in sterile tubes. Coagulate at 70° C. as in the case of serum.

¹ See also under Pfeiffer's bacillus and Gonococcus.

C. Boil an egg hard. Remove the shell, cut up the egg into pieces, and place in small Petri, or other covered glass, dishes. Sterilize the watch-glasses or dishes at 115° C.

D. Lubenau recommends yolk of egg media for growing tubercle and diphtheria bacilli. The procedure is as follows:

1. Prepare a neutral broth (p. 30) containing 1 per cent. of glucose (for the diphtheria bacillus) or 3 per cent. of glycerin (for the tubercle bacillus). Distribute in quantities of 100 c.c. in 2½-litre flasks. Sterilize.

2. Wash an egg with warm water and soap. Lay the egg in a Petri dish, pour a little alcohol over it, and set light to the alcohol.

Make a hole in the shell with a sterile instrument, and pour the yolk into one of the flasks of broth. Add the yolks of five eggs to each flask. Shake the flasks well.

3. Distribute the medium into tubes. Slope the tubes in a serum coagulator (p. 51). Heat for 2 or 3 hours at 90° C. on three successive days.

[E. Dorset's egg medium.—“The eggs are thoroughly cleansed with water of any adherent dirt, and then washed with 5 per cent. carbolic solution, and allowed to partially dry. The ends of the eggs are then gently dried in the flame, and pierced with a burned sharp forceps. The hole at one end should be about $\frac{3}{8}$ in. in diameter, and the membrane broken; the other end which is to be blown into should be smaller, and the membrane left unbroken if possible. The eggs are then blown into a sterile Erlenmeyer flask, the blowing being done from the cheeks, which will help to avoid spilling saliva and leakage of air around the outside of the egg. To the egg is then added 10 per cent. of water by volume of the weight of the eggs. The mixing is done by a twirling motion of the flask or by gently stirring with a glass rod. Bubbling is to be sedulously avoided. The mixture is then strained through cheese-cloth by gravity and tubed. The tubes are then inspissated at 70° C. for 2–2½ hours in a moist chamber” (Park and Krumweide).]

Meat.

Into a litre flask put 500–600 grams of finely chopped lean beef. Add sufficient normal soda solution to make the reaction neutral or slightly alkaline. Plug the flask with wool. Sterilize at 115° C.

Internal organs.

The placenta, liver, spleen, kidneys, etc., can be used as culture media. The organs must be removed with the usual aseptic precautions from healthy animals which have been recently killed.

The technique recommended by Guéniot for the preparation of placenta will serve as an example of the method of preparing these culture media.

1. Lay the placenta (if possible receive it) in a sterile basin with the uterine surface uppermost. Scorch this surface with a large heated metal plate.

2. Cut off a number of pieces with a sterile forceps and scalpel, and place them with the scorched surface downwards in sterile Petri dishes, or better in large sterile tubes.

Place the dishes and tubes in the incubator at 37° C. for a day or two to control the technique. Those that remain sterile (at least 60 per cent.) can then be used as culture media.

4. Vegetable media.**Potato.**

A. Petri dish method.—1. Select a number of perfectly sound potatoes, scrub away the soil adhering to them in running water, then dry and peel them.

2. Cut them into slices about 10–15 mm. thick parallel to their long axes, and drop the slices into a dish of distilled water.

The slices should not be touched with the fingers, and it is best to use a silver blade as steel often turns potatoes black.

3. Dry the pieces between folds of white filter paper.

4. Then lay them in Petri dishes (fig. 43) or other suitable covered glass dish.

5. Sterilize the potato in the dishes at 120° C. for 20 to 30 minutes.

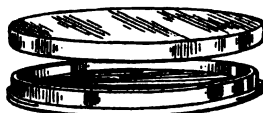

FIG. 43.—Petri dish.

Potatoes must be sterilized at 120° C., because a highly resistant organism (the potato bacillus), which is often present on the surface, may in slicing the potatoes be carried by the knife on to the cut surface.

B. Method recommended.—1. Wash and scrub the potatoes as above.

2. Cut the potatoes, not into slices, but into elongated parallelepipeds or semi-cylindrical pieces 4 to 5 cm. long, so that they can be put in special potato-tubes also known as Roux's tubes.



FIG. 44.—Potato-tube.

These tubes (fig. 44) are rather wider than ordinary culture-tubes and the potato rests on a constriction situated about the lower one-fourth; the bulb below collects the condensation water.

A special cutter may conveniently be used for slicing the potatoes, but the only advantage to be gained is that the pieces are more neatly and regularly cut. The slices should not be too long, otherwise they will curl when boiled.

3. Wash the pieces in distilled water: dry between blotting paper.

4. Put them into tubes. Plug with wool.

5. Sterilize as above.

Note.—Potatoes, though generally neutral in reaction, are sometimes strongly acid, in which case they are not suitable for the cultivation of bacteria. If it be necessary to use these acid potatoes, they must be soaked for some hours before being sterilized in a 0.5 per cent. solution

of soda.

[C. Glycerin-potato.—1. After cutting the potatoes into suitably shaped pieces as above (B), soak them in a dilute (1–1000) solution of sodium carbonate for 24 hours.

[2. Transfer the pieces to a 5 per cent. solution of glycerin in water for a further 24 hours.

[3. Tube in ordinary test-tubes, which should have a pledget of wool at the bottom. Fill up the tubes with the 5 per cent. glycerin solution.

[4. Sterilize at 100° C. on three successive days.

[5. When required for use pour off nearly all the glycerin solution, and sow the surface of the medium.]

D. Potato mash.—1. Peel the potatoes, cut them into large pieces, and boil them in water.

2. Pass them through a sieve.

3. Distribute the mash in layers 1–2 cm. thick in Petri, or other covered glass, dishes.

4. Sterilize at 120° C. for 20 minutes.

Starch jelly.

To 180 grams of water add 10 grams of potato meal and 5 grams precipitated calcium carbonate. Distribute in Erlenmeyer flasks or Petri dishes and sterilize at 115° C. When the starch cools it forms an homogeneous whitish layer on the bottom of the vessel.

Heinemann's jelly.—Heinemann recommends the following jelly in place of potato. The artificial medium has the advantage of being of constant composition and reaction.

1. Prepare the following solution :

| | |
|-----------------------------------|----------|
| Asparagin, - - - - - | 5 grams. |
| Di-potassium phosphate, - - - - - | 2 " |
| Di-sodium phosphate, - - - - - | 2 " |
| Magnesium sulphate, - - - - - | 2 " |
| Calcium chloride, - - - - - | 2 " |
| Ammonium lactate, - - - - - | 2 " |
| Water, - - - - - | 200 " |

2. Dissolve 15 grams of agar and 10 grams of peptone in the warm in 600 grams of water.

3. Mix the two solutions. Make neutral to phenol-phthalein. Filter.

4. After filtering, and while still hot, add 30 grams of starch made into an homogeneous suspension with a little water. Boil the mixture for several minutes.

5. Distribute in tubes. Sterilize at 120° C. for 5 minutes. Slope the tubes and allow them to cool.

Bread.

- A. Soak some slices of white bread in distilled water, place them in covered glass dishes, and sterilize at 115° C. for 20 minutes.

- B. 1. Crumble some bread and dry it in the air between sheets of filter paper.

2. When dry, grind it up in a coffee mill.

3. Put the powder in layers 1–2 cm. thick in Petri dishes or in Erlenmeyer flasks, and add sufficient distilled water to soak all the bread (about 2½ parts of water to 1 part of bread by weight).

4. Sterilize at 115° C. for 20 minutes.

Rice milk.

1. Mix intimately

| | |
|--------------------------|------------|
| Milk, - - - - - | 150 grams. |
| Peptone broth, - - - - - | 50 " |
| Powdered rice, - - - - - | 100 " |

2. Distribute the mixture in Petri dishes in layers 1–2 cm. deep.

3. Heat to 115° C. for 20 minutes. The mixture solidifies and forms an opaque white layer.

5. Coloured media.

Coloured media are used for the recognition of particular micro-organisms which produce changes of colour in them. Only a few formulæ are given here, the majority being reserved for description later (*vide* the typhoid bacillus, the colon bacillus, etc.).

Media tinted with blue litmus [or neutral-red] and containing a carbohydrate are the most generally used : organisms which ferment carbohydrates with formation of acid, when grown in a litmus medium change the colour of the litmus from blue to red [and in a neutral red-medium produce a bright red colour].

Preparation of litmus solution.—Granulated litmus is ground up, 85 per cent. alcohol is poured on to the powder, and the mixture boiled. 6 to 8 parts of water are added to the residue, and the resulting liquid mixture is heated and

filtered through paper. The filtrate is kept in a flask plugged with wool. To one-half of this liquid sulphuric acid is added until the colour is nearly red, and the other half then added to it; a sensitive indicator is thus obtained. The solution is distributed in tubes which are plugged and sterilized at 115° C.

Litmus-lactose-gelatin.

1. Prepare and sterilize a number of tubes of gelatin in the ordinary way (p. 39), adding (at stage 4) 2 to 4 per cent. of lactose.

2. Prepare a number of tubes of sterilized litmus solution.

3. Just before use, melt the lactose-gelatin in a water bath and to each tube add with a sterile pipette sufficient sterile litmus solution to impart a distinctly blue colour to the medium.

Never sterilize a medium after adding litmus: the subsequent heating is liable to discharge the blue colour.

Litmus-glucose-gelatin, litmus-mannite-gelatin, etc., and various litmus-agars are prepared in a similar manner.

Barsiekow's medium.

Prepare separately the two following solutions and sterilize them:

| | |
|---|--|
| A. Sodium chloride, - - - - - | 0.5 gram. |
| Nutrose, - - - - - | 1 " |
| Water, - - - - - | 75 grams. |
| B. The carbohydrate (lactose, mannite, etc.), - - - | 1 gram. |
| Water, - - - - - | 25 grams. |
| Litmus solution, - - - - - | Q.S. to give an amethyst tint to the solution. |

After cooling, mix the two solutions and distribute in tubes.

Litmus milk.

Add a sufficient quantity of sterile litmus solution to sterile milk. [It is highly important that the reaction of the milk should be neutral. Milk bought in shops is often acid, in which case a sufficiency of sodium carbonate must be added to neutralize the medium.]

Neggerath's medium.

1. Mix in the following proportions saturated aqueous solutions of the dyes mentioned:

| | |
|---------------------------|--------|
| Methyl-blue, - - - - - | 2 c.c. |
| Gentian-violet, - - - - - | 4 " |
| Methyl-green, - - - - - | 1 " |
| Chrysoidine, - - - - - | 4 " |
| Fuchsin, - - - - - | 3 " |

2. Add 200 c.c. distilled water.

3. The mixture now has a neutral greyish-blue tint: leave it to stand for a fortnight, then if the colour has altered bring it back to the neutral tint by the addition of any colour that is required. Sterilize at 100° C.

4. Immediately before use add 7 to 10 drops of the sterile mixture to a tube of agar or gelatin previously melted in the water bath.

In place of the above mixture, Gasser prefers to add 20 drops of a saturated aqueous solution of fuchsin to each tube of melted agar.

These media were recommended by their authors for the diagnosis of the typhoid bacillus, but have now fallen into disuse (*vide* the typhoid bacillus).

CHAPTER III.

INCUBATORS.

Introduction.

Section I.—Devices for automatically regulating the temperature of incubators, p. 59.

Section II.—Incubators heated by coal gas, p. 61.

Section III.—Incubators heated by electricity, p. 65.

Section IV.—Incubators heated by petrol, gasoline, or petroleum oil, p. 66.

AN incubator is a piece of apparatus designed to maintain cultures of organisms constantly at any temperature which may be best suited to their growth.

The **shape** of the incubator, provided it be adapted to the size of the tubes, flasks, etc., which it will have to receive, is generally speaking of little consequence, though on the whole the rectangular form is the most convenient because the space can be most completely utilized.

Any metal box which had a door and could be heated by a convenient source of heat could in an emergency be made to serve as an incubator. A rectangular tin or copper box for instance, raised on a suitable stand, and heated by a [Bunsen burner or] small oil lamp, placed below it at such a distance as to keep the temperature within the box at the level required, would do quite well. But with such a rough and ready piece of apparatus the difficulty would be to keep the temperature constant, for quite apart from the question of the control of the heat supply the temperature would be influenced by the temperature of the outside air. And in practice these difficulties are so considerable that it has been found necessary to design special forms of apparatus in which the temperature can be kept more fully under control. These of course are more complicated and more expensive than the simple arrangement just referred to, but are nevertheless indispensable if satisfactory results are to be obtained.

There are two essential points for which provision must be made in the construction of an incubator.

Firstly, the instrument must be protected as far as possible from variations in the atmospheric temperature, and from loss of heat by radiation and convection.

Secondly, it must have some form of automatically acting regulator, which will readily respond to variations of temperature.

The former condition is satisfied by surrounding the outer surface with some non-conductor of heat, e.g. wood or felt or a water jacket; or, since polished metal surfaces radiate heat very feebly, a veneer of brightly polished copper will serve the purpose equally well.

To get the most satisfactory results, the temperature throughout the incubator must be as uniform as possible. If the incubator were an hermeti-

cally sealed box, there would be very marked differences of temperature at different levels, and the larger the incubator the more noticeable would this be. [In very large incubators, such as incubator rooms, it is even necessary to have thermometers on each shelf and at different places on each shelf, because the differences of temperature in different parts of the room are so considerable.] Hence to maintain as uniform a temperature as possible in an incubator of the ordinary size the shelves are perforated with holes to allow of free circulation of the air, and in some forms ventilation holes are provided in the floor and roof. [With incubators surrounded by a water jacket however this is not necessary.]

SECTION I.—DEVICES FOR AUTOMATICALLY REGULATING THE TEMPERATURE OF INCUBATORS.

Various ingenious pieces of mechanism have been devised for the purpose of automatically regulating the temperature of incubators. Some of these regulators are intended to be used when coal gas is the source of heat, others are constructed for use with paraffin oil, etc., but the former are the most satisfactory, and are the only ones that can be recommended.¹ Those that are in most general use are described below.

A. Electric regulators.—Of these Babès' may be mentioned as a type. They are very complicated, uncertain in action, and have no advantage over the following.

B. Mercury regulators.—To explain the principle of the mercury regulators, Chancel's may be described. The gas enters through the glass tube A (fig. 45), which terminates within the regulator in an oblique opening through which the gas issues and passes to the burner through the side tube B. When the regulator is placed within the incubator, the mercury contained in the lower part R expands as the temperature rises, so that in time it obliterates the oblique opening of the tube A, and consequently diminishes the volume of gas passing to the burner (in the vertical limb of A there is a small safety opening O which permits of a very small supply of gas to the burner, just sufficient to prevent the light going out altogether when the opening below is completely obstructed by the mercury).

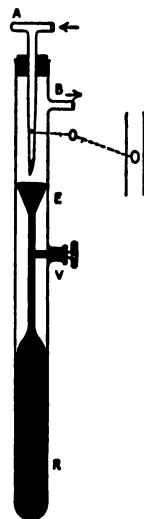

FIG. 45.—Mercury regulator.

When the temperature within the incubator drops, the level of the mercury falls and the supply of gas to the burner is increased. The regulator is controlled by the screw V: when this is turned clockwise the level of the mercury E stands at a higher level for any given temperature, while by turning it contra-clockwise, the volume of mercury in the tube is diminished. This regulator is cheap but not very sensitive, and is only correct within about 3° C.; an improved form of it has been devised by Arloing.

C. Ether regulators.—Rohrbeck's (fig. 46) may be taken as an example of this form of regulator, the working of which depends upon alterations in the vapour tension of ether at different temperatures.

¹ To ensure as constant a temperature as possible with gas, a pressure-regulator should be affixed to the main, so that the gas always reaches the incubator at a constant pressure.

Entering the smaller tube A (fig. 46), the gas passes by way of its lower obliquely cut end through B to the burner. The outer tube is divided towards its lower part by means of a funnel-shaped glass partition E into an upper and lower part. The lower part R is filled below with mercury, and above with ether vapour. When the surrounding temperature rises the pressure of ether vapour increases, and the mercury rises in the funnel and gradually more or less occludes the lower opening of A, thus cutting off the supply of gas to the burner. A pilot opening O is provided, so that the gas shall not be completely extinguished. The apparatus is regulated by raising or lowering the tube A. The regulator is sensitive but fragile.

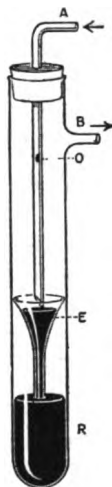

FIG. 46.—Ether regulator.

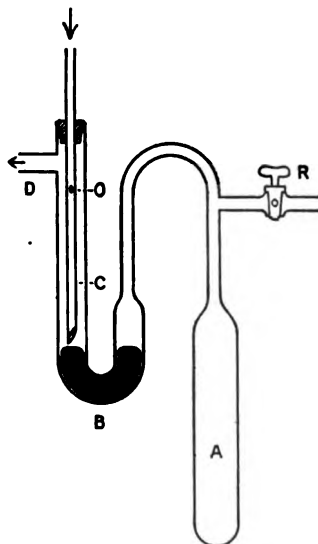

FIG. 47.—Air regulator.

D. Air regulators.—Of these, Bohr's may be taken as an example (fig. 47). In principle they are similar to the ether regulators, air replacing the ether in the latter.

The regulator is fitted to the incubator with the tap R open, and the reservoir A full of air. When the temperature of the incubator has reached the temperature required, the tap R is closed. If now the temperature of the incubator be raised the air expands, presses on the mercury contained in the U-tube B and forces it upwards thus partially or completely occluding the oblique opening C of the gas supply tube, and so cutting off more or less completely the gas passing to the burner through D. The gas delivery tube is provided with a safety opening O as usual. The regulator is sensitive, but being affected by alterations in the atmospheric pressure requires a certain amount of supervision.

E. Roux's metal regulator.—This regulator is composed entirely of metal (fig. 48). It consists of a strip of zinc and a strip of steel soldered together, and then bent in the form of an U. The metal with the greater co-efficient of expansion, zinc, being on the outside, it follows that any increase of temperature will cause the open ends of the U to approach each other; and conversely if the temperature of the metals be lowered the gap between the limbs is widened.

The left limb of the U is fixed while the right limb R is free, and therefore any change of shape resulting from a rise or fall of temperature in the incubator is integrated on the free limb R, and transmitted by means of a rigid horizontal bar T to a piston placed outside the incubator which controls the supply of gas.

The tube C being connected to a gas tap, the gas must pass under E to reach the chamber to which the tube D leading to the burner is connected.

As the temperature in the incubator rises, the free limb R is drawn towards the other limb taking the rigid bar T with it; the piston, controlled by a spring, closes (this is shown in the figure), only leaving a small safety hole or by-pass V by which the gas can pass to the burners, and accordingly the temperature is lowered. When the temperature is too low, the changes described are reversed;

the bar is pressed upon by the right limb of the U, and this in turn forces the piston E out so that more gas passes to the burners and the flames are larger. After a few oscillations, the temperature in the incubator will become constant.

By altering the length of the rigid bar T by means of a screw, the temperature can be raised or lowered as required; or as in the pattern shown in the figure, which gives more delicate control, the length of the rigid bar is fixed while the length of the piston can be altered by means of screws.

In some cases the zinc and iron bars are straight, and the apparatus assumes the form of a metal tube. This modification is useful when the regulator has to be immersed in water, as for instance in a water bath or a water-jacketed incubator.

Roux's regulator can be utilized for controlling the temperature of gas stoves used for heating incubating rooms and stoves in laboratories.

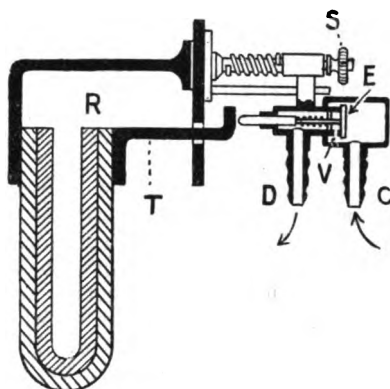

FIG. 48.—Roux's metal regulator.

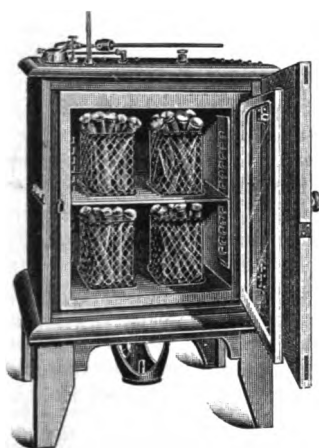

FIG. 49.—Hearson's "warm" incubator arranged to work with gas.

SECTION II.—INCUBATORS HEATED BY COAL GAS.

A. Hearson's incubators (fig. 49).—[These are most satisfactory incubators, and are almost if not quite the only ones used in this country. There are two forms, a "hot incubator" for temperatures of about 37° C. and a "cool incubator" for 20° C. or thereabouts. Incubators on the same principle can however be obtained to work at any temperature above 16° C.]

[1. **The "warm" incubator.**—This, when once set, will work perfectly for months together without adjustment of any part and without any attention beyond the occasional addition of a little water to replace the small amount

lost by evaporation. In actual practice it is found that the temperature can be maintained within half-a-degree centigrade in spite of great changes of gas pressure and of air temperature in the room in which the incubator is working.

[The incubator is rectangular in shape, and consists of a chamber surrounded on five sides by a stout copper water jacket enclosed in an outer wooden case with panels of uralite, the space between the case and the water jacket being packed with some non-conducting material. The sixth side is closed by a double door, the inner of glass, the outer of wood also panelled with uralite.

[The heat is supplied below by an ordinary fish-tail gas burner, the supply of gas necessary to maintain the temperature being controlled by a capsule let in to the roof of the incubator.]

The regulator is based upon the same principle as that of Rohrbeck (p. 59). An hermetically sealed metal capsule containing a few drops of a liquid boiling at the temperature at which the apparatus is required to work is placed within the incubator. When the liquid in the capsule boils, the expansion of the liquid lifts the upper part of the capsule, and so raises a metal rod which actuates a lever controlling the supply of gas. A small safety tube prevents the gas being extinguished when the main supply is cut off by the lever.

[*Technique.*—As full instructions are attached to every incubator, it is unnecessary here to describe the details.]

[2. **Hearson's "cool" incubator.**—The incubating chamber is similar in construction to the "hot" incubator, but on the top is a metal box of the same size as the incubator, surrounded by a thick layer of non-conducting material or wood, and with a large hole in the top through which ice can be introduced. The temperature is controlled by a capsule similar to that used for the hot incubator, but designed to work at about 20° C.

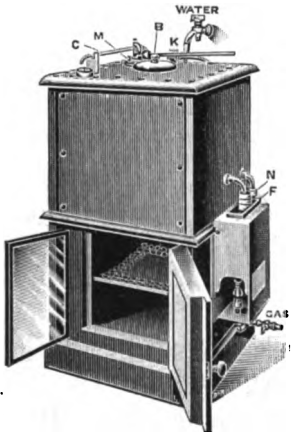

FIG. 50.—Hearson's "cool" incubator.

[The source of heat is a small bath of water placed at the side but near the top of the incubator, and heated by a Bunsen burner. The capsule controls a small pipe connected with a supply of water in such a way that when the temperature is that for which the capsule is set, the water runs to waste; when the temperature has fallen below that required the pipe conveys the water to the little bath, and hot water runs into the incubator jacket, displacing some of the cooler water. When the temperature is too high the cold water runs directly into the water

jacket, and if this be insufficient to reduce the temperature then ice must be put in the box. In this country it is very rarely, if ever, that ice is required.

[The only difficulty likely to be experienced with this incubator is in connexion with its water supply. If the supply be taken directly from the main, the water may be cut off or the pressure for one reason or another be so reduced from time to time that the automatic regulation breaks down: so that for satisfactory working it is desirable to have a tank from which a supply of water under constant pressure may be derived.]

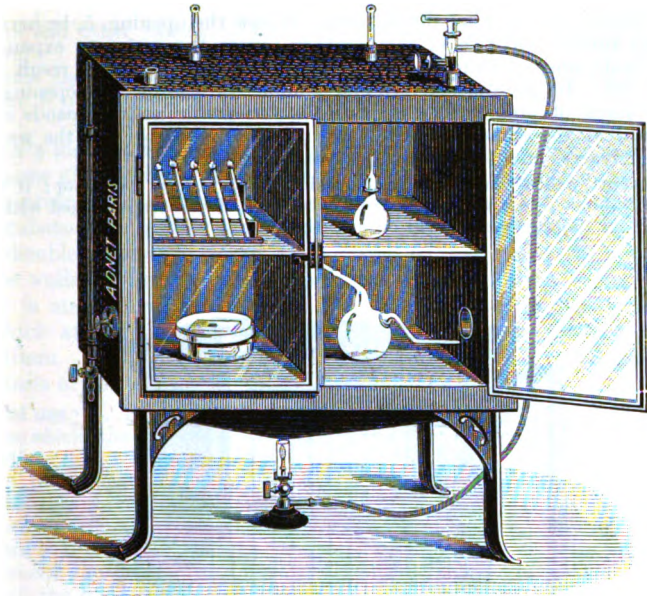

FIG. 51.—Babès' incubator, fitted with a Chancel regulator.

B. Babès' incubator.—One of the simplest forms of incubator is that known as Babès'. It consists of a metal box covered with a layer of felt, and heated by a gas flame the height of which is controlled by one or other of the many forms of regulators devised for the purpose (p. 59).

C. D'Arsonval's incubator.—The control of the temperature in d'Arsonval's incubator depends upon the changes of shape which an elastic lamina undergoes under the influence of changes of pressure.

The incubator is surrounded by a water jacket (2, fig. 52), of which the outer wall is closed below by a flexible sheet of steel, (3, fig. 52), which also forms the roof of a chamber, 10, into which a tube, 12, connected with the gas supply passes. From this chamber the gas reaches the burners through two tubes, 13 and 13'. The end of the tube, 12, can be made to approach or recede from the steel lamina, 3, by means of a screw. When the tube touches the steel the gas is completely cut off, and conversely, when they are separated the gas can pass freely to the burners.

The space between the two walls is hermetically sealed everywhere, except above where an opening, 5, is left for the purpose of filling the space with water. Suppose it be required to regulate the apparatus for a temperature of 37° C. The tube, 12, is screwed down away from the steel lamina, 3, so that the gas burns with a full flame. When the thermometer in the incubator registers 36° C., the tube is raised towards the lamina so that the

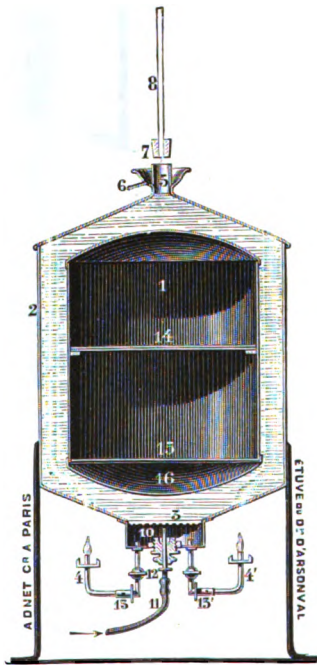

FIG. 52.—D'Arsonval's incubator in section.

size of the flames is somewhat diminished. If now the opening, 5, be hermetically plugged, any further increase of temperature causes the water to expand within the double wall, and so to force the lamina downwards, with the result that the gas is cut off. In practice, instead of completely sealing the opening a plug carrying a piece of glass tubing is inserted, and as the water expands it rises in this tube and at the same time the pressure on the bottom of the wall of the incubator increases, and the lamina is pressed down.

Note.—Recently-boiled water should be used for re-filling the incubator: if tap water be used the bubbles of air which are driven off when the water is heated will alter the water level, and the mechanism will be disturbed.

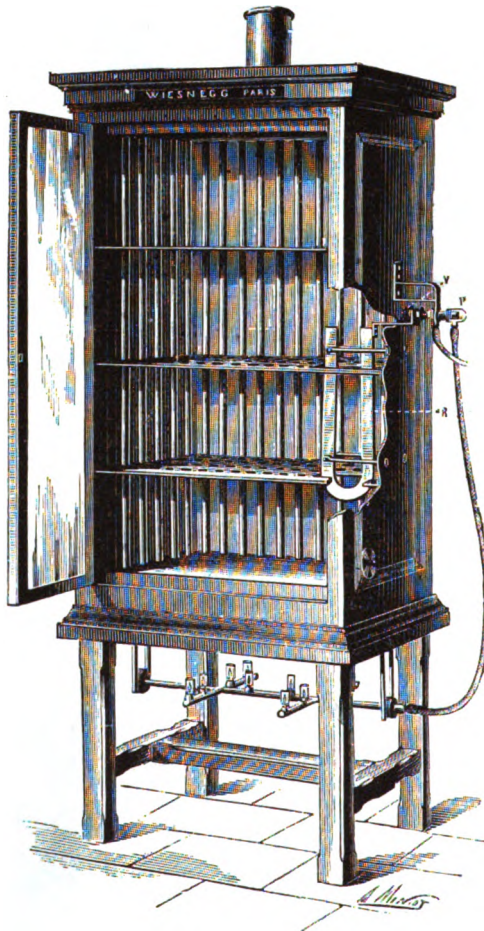

FIG. 53.—Roux's incubator.

In another form the regulator is placed in the side of the incubator, and a rubber membrane which is more sensitive is substituted for the steel lamina.

D'Arsonval's incubator has several disadvantages.

1. By reason of its shape only a small part of its total capacity is available for use.

2. The regulation of the temperature being a function of the level of the water in the tube, 8, it follows that the temperature within the incubator rises as the height of the water falls. Since this may happen as a result of evaporation, leaking

from joints and other causes, it is apparent that the apparatus requires careful supervision.

3. In time the elasticity of the lamina diminishes, with the result that the temperature is not controlled.

D. Roux's incubator.—Roux's incubator meets all practical requirements, and has none of the disadvantages of Babès' and d'Arsonval's, and for these reasons is preferable to those instruments.

The incubator consists of a rectangular wooden box, closed in front by a single or double glass door raised on feet and heated below by a gas burner. The inside walls are lined by a series of vertical copper tubes. The air in the incubator is maintained at a constant temperature by radiation from these tubes, which are heated by the gases from the burners below passing up through them. Ventilation is provided through holes in the floor and roof.

For details of the regulator, see p. 60.

Method of use.—1. Before using the incubator, it is well to paste black paper over the doors to shield the cultures from light, which may have an adverse influence on their growth.

2. Lay a thermometer on each shelf to watch the rise of temperature. When the incubator is finally regulated, each shelf has an absolutely constant temperature, which differs slightly from that of the shelf above and below.

3. The tube C (fig. 48, p. 61) is connected to a gas tap, and the tube D to the burners beneath the incubator. Adjust the screw S controlling the piston E, and turn it until the latter is widely open.

4. Light the gas.

5. When the temperature on the middle shelf registers half-a-degree below the temperature required (36.5° C. if a temperature of 37° C. is required), turn the screw S until the piston E is closed, and the burner is fed only by the by-pass V. But when the temperature in the incubator falls, the limbs of the metal U separate, the rod T presses on the piston rod, with the result that the piston E is opened, and a larger volume of gas reaches the burner. The apparatus is now regulated, and the temperature will remain constant without further supervision. If the gas be turned off at the main and then relit, the temperature will be regulated at the height at which it stood when the gas was turned off. A little vaseline must be applied to the piston chamber from time to time to lubricate the piston rod.

SECTION III.—INCUBATORS HEATED BY ELECTRICITY.

When a laboratory has electric power laid on, it may be convenient to use incubators such as those of d'Arsonval, Regaud, Fouillaud [or Hearson] which can be heated with electricity.

A. D'Arsonval's electrical incubator is similar in appearance to Roux's incubator. It is fitted below with a drawer in which the special form of lamp used for heating the incubator is placed. A metallic regulator is interposed in the circuit: as the temperature rises it causes the expansion of a metal rod, and this breaks the circuit and cuts off the current. When on the other hand the temperature falls the bar returns to its normal position in contact with a platinum point, and the circuit is re-established. To regulate the incubator a screw is turned until the current passes. When a thermometer placed in the incubator registers a few degrees below the temperature required, the screw is slightly reversed. The temperature is noted again in about half-an-hour's time, and after a few trials the regulation is quite perfect.

B. Hearson's electrical incubators.—Hearson's regulator (p. 62) can be applied to incubators heated by electricity. The circuit is broken and the current cut off when the lever is raised by the expansion of the fluid in the capsule.

**SECTION IV.—INCUBATORS HEATED BY PETROL, GASOLINE,
OR PETROLEUM OIL.**

When neither coal gas nor electricity are available as sources of heat, it is difficult to regulate the temperature of an incubator satisfactorily.

In these cases, incubators heated by petrol (Lion's, d'Arsonval-Adnet's, Hearson's) or by gas manufactured on the spot from gasoline (Roux's, Hearson's), [or by petroleum oil (Hearson's)] should be used, but they all require a good deal of supervision.

CHAPTER IV.

THE METHODS OF SOWING AND CULTIVATING AËROBIC ORGANISMS.

Introduction.

Section I.—Instruments used for sowing cultures, p. 67.

Section II.—The methods of sowing cultures, p. 70.

Section III.—Conditions essential to satisfactory growth, p. 72.

Section IV.—The examination of cultures, p. 73.

Section V.—Methods of storing cultures, p. 75.

AËROBIC organisms should be grown in vessels which while allowing free access of air at the same time protect them from dust.

Various types of culture vessels are in use : for instance test-tubes, circular flat-bottomed flasks, flasks of various other shapes, Petri dishes, Soyka dishes, etc.

Cotton-wool is generally used as a protection from dust. More rarely paper caps and occasionally glass covers are also employed.

In sowing a culture, the following rules must be observed :

1. *The instrument used must be sterile.*
2. *The material to be sown must be collected without introducing extraneous organisms :*
3. *And must be transferred uncontaminated to the medium it is proposed to sow.*

SECTION I.—INSTRUMENTS USED FOR SOWING CULTURES.

Cultures can be sown with a *Pasteur pipette*, *platinum wire*, or *glass needle*.

A. Pasteur pipettes.

This consists of a piece of glass tubing drawn out in the blow-pipe, and sealed at the pointed end, the other end being plugged with cotton-wool. The pipette should be about 20 to 25 cm. long.

A number of these pipettes ready sterilized should always be at hand.

To make a Pasteur pipette.—1. Take a piece of glass tubing of 5 to 7 mm. calibre (the size of a lead pencil), and with a file mark it off into lengths of 25 cm. or thereabouts. (Glass tubing is sold in lengths of about 1 metre, and each length should therefore cut up into four pieces.)

2. Break the tubing by holding it in both hands and pressing the thumbs against the glass, one on each side of a file mark.

3. Round off the cut ends in the blow-pipe.

4. Plug the two ends of each piece with cotton-wool, which should pass some distance into the tubing and should also project a few millimetres from the open end (fig. 54). This is conveniently done by gently pressing the wool in with some blunt-pointed instrument (the thin end of a three-cornered file will do very well).

5. Hold the middle of the tube in a slightly inclined position and heat it in a medium-sized blow-pipe flame, turning it round and round between the thumb and index fingers until the glass is soft. Withdraw the tube from the flame and draw it out quickly into a fine tube about 30 cm. long (fig. 54, A). Divide it into two in the middle by melting it in the tip of the flame. This will give two pipettes with the capillary end of each sealed.

A certain amount of skill is required to make these pipettes. Care should be taken that the tube is drawn out straight, and this can best be done by the operator resting his elbows on the table. The tube should always be taken out of the flame before attempting to draw it, and it should be held horizontally while being drawn. The tube should not be drawn too fine, otherwise it will be too fragile for use.

6. Place the pipettes with their plugged ends downwards in a wire basket

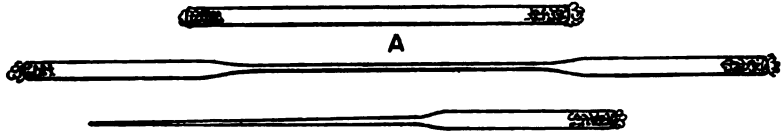

FIG. 54—The method of making pipettes.

[or copper cylinder, fig. 1], and sterilize them at 180° C. in the hot air sterilizer. They are then ready for use.

Method of using a Pasteur pipette.—1. Break off the fine sealed end of the pipette with a pair of dissecting forceps or between the thumb nail and the pulp of the index finger [it is better to make a light scratch with a carborundum pencil before breaking off the point].

2. Pass the broken end through the flame of a Bunsen burner or spirit lamp to destroy any organisms which may happen to have been deposited on the surface.

3. Dip the sterile end into the fluid which is to be used for sowing the medium. The fluid will rise in the tube by capillarity, or it can be aspirated by slightly withdrawing the wool in the other end of the tube. [A convenient practice consists in slipping an india-rubber teat over the wool-plugged end. By pressing on the teat, air is expelled: if the capillary end be now dipped in the fluid and the pressure on the teat lightly relaxed, as much or as little of the fluid as is required can be drawn up into the tube.]

In doing this, care must be taken that the aspirated liquid does not soil the wool plug; and it is necessary also to watch that bubbles of air are not drawn in.

4. Transfer the fine end of the pipette as rapidly as possible to the medium to be sown, and let one or more drops of the fluid fall on to the medium, either by its own weight or by blowing gently through the other end [or by compressing the teat.]

5. The aspirated fluid can be kept free from contamination for an indefinite time by sealing the end of the pipette. Thus, tilt the pipette gently so that the fluid runs up the tube; heat the point in a small flame (the pilot flame of a Bunsen), and when the glass is soft, draw it out with a pair of forceps, and the tube is completely closed.

B. Platinum wires.

Platinum is to be preferred to all other metallic wires because it does not oxidize after being heated to redness. The wire must be suitably mounted in a glass or metal handle, since on account of its high conductivity it cannot otherwise be held in the fingers.

A platinum wire (German, *üse*) so mounted meets all requirements. It is convenient to have three sizes of wire, stout, medium and fine: each will serve a special purpose (fig. 55). The fine wire is the most generally useful, because it cools more quickly than the stouter wires, and this is an important consideration in the successful sowing of cultures. At the same time it has very little rigidity and is easily bent, so that it cannot be used for instance, to sow cultures which adhere firmly to solid media, nor for sowing a rough-surfaced medium such as potato.

In the laboratory there should always be at hand:

A fine straight wire for sowing stab cultures (fig. 55, A).

A stout wire whose point is flattened in the form of a spatula (fig. 55, B).

A medium-sized wire, which can be bent to any desired angle near its end (fig. 55, C).

A fine wire bent into a loop at the end for picking up a drop of fluid (fig. 55, D).

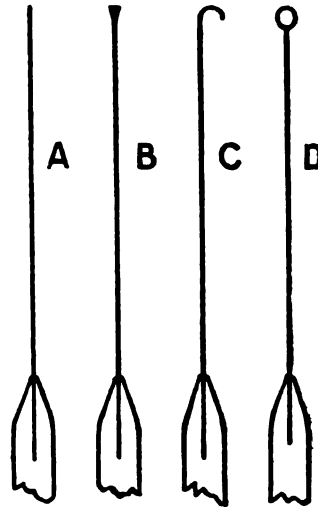

FIG. 55.—Platinum wires.

Method of mounting platinum wires.—1. Take a glass rod 5–7 mm. in diameter, and divide it into lengths of 20–25 cm. by making a mark with a file and then breaking the rod at this mark between the thumbs.

2. Cut the requisite number of lengths of platinum wire with a pair of strong scissors, making each 5–7 cm. long.

3. Take one of the pieces of glass rod in the left hand, soften one end in the blow-pipe, rotating it between the fingers meanwhile. With forceps in the right hand pick up one of the pieces of platinum wire, holding it about 15 mm. from one end, and heat this end to a white heat in the flame.

4. When the heated end of the glass rod is softened, push the hot end of the platinum wire into it, so that a centimetre or more is embedded in the rod. Heat for a few moments, [pull out slightly] and then allow to cool.

5. Round off the rough edge of the other end of the glass rod in the flame.

6. Then with a pair of dissecting forceps bend the projecting end of the wire into a loop or at a right angle, or flatten it with a hammer, as the case may be.

Technique.—1. Hold the glass rod by its upper one-third, and pass the other end to which the platinum wire is fused rapidly through the Bunsen to destroy any organisms which may be present on the surface.

This sterilization of the glass rod should be done rapidly, because the smooth surface of the glass is quickly sterilized and moreover does not come into immediate contact with the culture: if the glass be overheated there is a risk that it may crack at the point where the wire is fused into it.

2. Heat the wire to redness, and on taking it out of the flame let it cool for a few seconds in the air.

The wire must not be exposed to the air any longer than is necessary for it to cool otherwise it may be contaminated by dust, and it is because it cools more quickly that a fine wire is most generally used.

3. Pick up the material to be sown on the needle, and transfer it to the medium to be inoculated.

4. When the culture is sown, heat the platinum wire to redness to destroy any organisms which may still be present on it.

This is particularly important when dealing with pathogenic micro-organisms. If the needle be not sterilized immediately, it will soil the bench and anything else it may touch.

C. Glass needles.

Draw out a piece of glass rod in the same way as the tubing was drawn out when making Pasteur pipettes. Then with a glass-cutter, [file, or piece of carborundum pencil] divide the fine part squarely in the middle. In this way needles of any degree of fineness can be made.

These needles are not so easy to handle as a platinum wire, but have the advantage of being rigid. They are useful for sowing deep stab cultures in gelatin.

Flame the needles immediately before using them.

SECTION II.—THE METHODS OF SOWING CULTURES.

A culture medium may be sown from another culture, or with water, dust, blood or other material. The method of collecting material differs of course according to the source whence it is derived—and this will be dealt with later (Chap. XII.)—but the technique of sowing cultures is not affected by these variations. Assume for the moment that a sub-culture is to be sown from an already existing culture, and take as an example a broth culture of the anthrax bacillus.

The process may be divided into three stages.

- (i) The opening of the tube from which the culture material is to be taken.
- (ii) The removal of the material.
- (iii) The sowing of the new medium. Here several alternatives present themselves. It may be required to sow—
 - (a) Broth, or other liquid medium.
 - (b) Stroke cultures on agar, gelatin, serum or potato.
 - (c) Gelatin stab cultures.

(It is sometimes required to sow single colonies—for isolating organisms in pure culture: this will be dealt with separately in a later chapter.)

These various problems will now be considered *seriatim*.

A. Method of sowing a liquid medium.—Broth may be taken as a type of liquid media.

1. Take a tube of sterile broth and the tube containing the organism. Flame the plugs of both tubes to burn off the dust which has collected on them. Loosen the plugs by screwing them round with the thumb and index finger of the right hand, at the same time slightly withdrawing them.

2. Place both tubes side by side in the left hand, holding them as nearly horizontally as possible. The bottom of the tubes should rest in the hollow of the hand, their upper parts being grasped between the thumb, index and middle fingers.

3. Take a platinum loop between the index and middle finger of the right hand, and sterilize it as already described.

4. While the needle is cooling, take the plug, which has already been

loosened, out of the tube containing the organism with the thumb and index finger of the right hand. Hold the plug between the thumb and first finger.

5. Introduce the platinum wire into the tube, being careful not to let it touch the sides of the mouth. Take up a drop of the culture fluid in the loop, and withdraw the latter from the tube (fig. 56). Flame the mouth of the

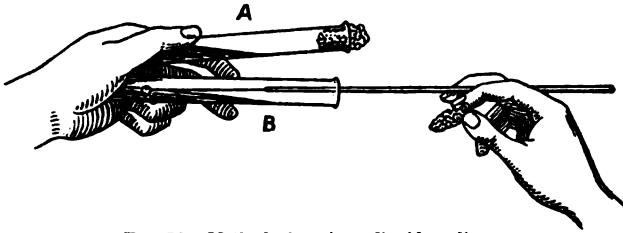

FIG. 56.—Method of sowing a liquid medium.

tube at once to destroy any organisms which may have settled on it during the process, and replace the plug as quickly as possible.

6. Take the plug out of the other tube, dip the loop into the broth, and after withdrawing it flame the mouth of the tube and replace the plug as before.

7. Before laying the platinum loop on the bench, heat it to redness to destroy any organisms which may still be adhering to it (in this particular case the anthrax bacillus, an organism pathogenic to man).

8. See that the tubes have been securely plugged.

Write on the tube which has been sown the nature of the organism and the date when it was sown.

It is often convenient to cover the wool plug with a small cap. This is readily done by twisting over the top a small strip of paper, which has been rolled round its upper part. The details of the culture can be written on this (fig. 57): paper caps, however, are liable to be interchanged, so that it is at least a wise precaution to label the tube as well. The cap has the advantage that it protects the wool from all liability to contamination.

Notes.—It is of the utmost importance that culture-tubes which have to be opened should be held in an oblique, nearly horizontal position so that dust may not fall into them.

No time should be wasted during the sowing of cultures, in order to minimize the chances of them becoming contaminated.

Wool plugs must never be laid on the bench. The part of the plug which goes into the tube ought to be prevented from touching anything.

The handle of the platinum needle should never touch the medium.

B. Method of sowing stroke surface cultures.—As an example of this, the sowing of a sloped agar tube may be described.

1. Proceed as under A, substituting a tube of sterile agar for the sterile broth.

2, 3, 4, 5. As under A.

6. Remove the plug from the agar tube, place the end of the wire on the lowest part of the surface of the agar, and draw it in a straight or zig-zag line over the medium.

7, 8. As under A.

Note.—In sowing potato the technique is the same as above, but more pressure must be used in drawing the needle over the surface and a medium or stout wire is desirable.



FIG. 57.—Culture-tube protected with paper cap.

C. The sowing of stab cultures.—The method of sowing a stab culture in gelatin will be described.

1. Proceed as under **A**, substituting a tube of sterile gelatin for the broth tube.

2. Hold the two tubes in the left hand thus: place the culture from which the material is to be taken in the hollow of the hand, supporting it between the thumb and first finger, and keeping it as nearly horizontal as possible. Place the gelatin tube between the first and second fingers, so that it is held firmly between the dorsal surface of the index finger and the palmar surface of the second, with the mouth pointing vertically downwards.

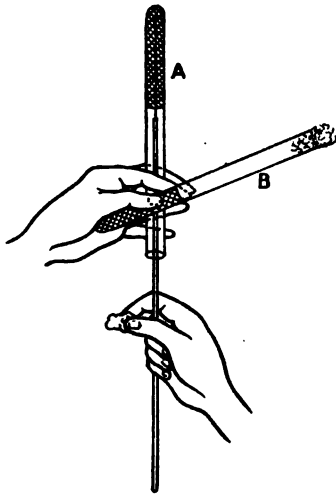

FIG. 58.—Method of sowing a stab culture.

3. Hold the *straight* platinum wire in the palm of the right hand, leaving the thumb and index finger free. Sterilize the needle.

4 and 5. As in **A**.

6. With the thumb and first finger of the right hand remove the plug from the gelatin tube. Hold the already charged platinum wire vertically below the mouth of the tube, pass it into the tube until it touches the surface of the gelatin, let the gelatin tube fall by its own weight on to the wire until the latter touches the bottom, then withdraw it sharply (fig. 58).

7, 8, 9. Complete the operation as in **A**.

Notes.—It is difficult by *forcing* the needle into the gelatin to get a straight stab which reaches to the bottom without touching the sides. A satisfactory stab will be more easily secured by allowing the gelatin to impale itself on the needle. The tube must therefore be held vertically, and not obliquely.

Gelatin which has been made some time is often cracked: in that case stand the tube in a water bath until the medium is liquefied, then let it set, and the gelatin will be found to be quite homogeneous again.

SECTION III.—CONDITIONS ESSENTIAL TO SATISFACTORY GROWTH.

To ensure growth taking place after the medium has been sown, the following conditions must be fulfilled:

(a) The cultures must be freely exposed to the air but at the same time be protected from dust. This condition is readily satisfied by the use of the ordinary wool plug, paper cap, etc.

(b) The temperature must be kept constant.

(c) As far as possible light must be excluded.

The two latter conditions are met by keeping the cultures in an incubator (Chap. III.).

Some micro-organisms grow only at temperatures above 30° C.,—generally 37° or 38° C.,—while others only grow well at temperatures below 30° C. Gelatin cultures of course must not be exposed to a temperature above 20°–22° C.

In the laboratory it is useful to have three incubators:

1. One in which the temperature is maintained at 20°–22° C. (the cool or gelatin incubator).

2. A second in which the temperature is 37°–38° C. (the warm incubator).

3. A third in which the temperature can be altered to meet special cases. Such an incubator is required sometimes for cultures which need a temperature above 38° C. (39°–41° C.), and at other times for growing organisms at temperatures between 20° and 37° C.

(d) The medium must be suitable to the needs of the organism to be grown. All organisms cannot be grown indifferently on any medium; for while some require a medium rich in albuminoid matter, others prefer sugars, glycerin, etc., and others again will not grow on serum, or potato, and so on. In a later part of the book, when discussing individual organisms, mention will be made of the media most suitable for the growth of each species.

SECTION IV.—THE EXAMINATION OF CULTURES.

Cultures should be examined daily or even two or three times a day, and the character of the growth, which is of great importance in determining the species to which an organism belongs, noted.

Attention should be particularly directed to the following points :

A. In the case of micro-organisms growing in artificial cultivation, no matter what the medium, note :

1. (a) *The optimum temperature of growth, (b) the limits of temperature within which growth takes place.*

2. *The time when growth first makes its appearance.*

B. When cultures are growing in liquid media, note :

1. *The mode of growth.* Growth may produce :

(a) A distinct cloudiness of the medium, which may be either an uniform cloudiness or a cloudiness with a watered silk appearance, or sometimes a cloudiness with a surface pellicle. In these different cases flocculent deposits may ultimately form, and if so their occurrence should be noted.

(b) No distinct turbidity of the medium. Under these conditions the growth may show : (α) a surface pellicle, which may be either thin or thick, fatty or wrinkled ; (β) a ring of growth round the wall of the tube at the surface of the liquid ; (γ) flocculent deposits in the liquid, which may subsequently precipitate ; (δ) fine granular deposits, which in some cases adhere to the walls of the tube and in others fall to the bottom of the medium.

2. *The colour of the growth.*

3. *The production of any smell during growth.*

4. *The development of any new substances in the medium (toxins, indol, acid, ammonia compounds, etc.).*

5. *The presence or absence of clot when grown in milk.*

C. In the case of stroke cultures :

(i) **On agar, potato or serum, note :**

1. *The mode of growth.*

(a) The growth may remain limited to the line of sowing, and in this case it should be further noted whether (α) the culture takes the form of a delicate homogeneous and transparent streak, or occurs as discrete colonies ; or (β) whether the streak be thick, and if so if it be moist, greasy, viscous, dry or wrinkled.

(b) The growth on the other hand may spread widely over the surface of the medium, and the nature of the growth, that is to say whether it be moist, greasy, viscous, dry or wrinkled, is to be noted.

2. *The colour of the growth.* Whether the line of growth or the surrounding medium is pigmented.

3. *The production of any odour.*

(ii) **On gelatin, note :**

1, 2, 3. *The form, colour and smell of the growth as in the preceding cases.*

4. *Whether the organism liquefies the medium, and if so, the time at which liquefaction begins.*

D. In the case of stab cultures in gelatin, note :

1. *The mode of growth.*

The following appearances are observed with different species :

(a) A straight line along the line of sowing (fig. 59).

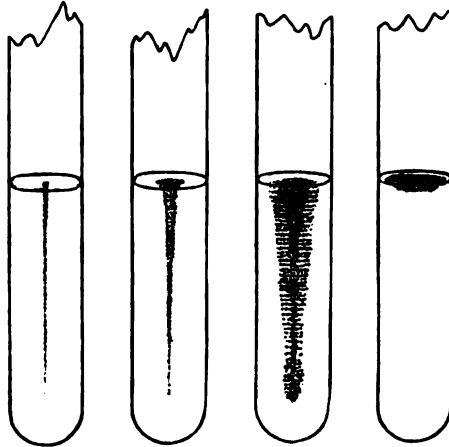

FIG. 59.—Rectilineal growth. FIG. 61.—Arborescent growth.
FIG. 60.—Tylotate growth. FIG. 62.—Surface growth.

Stab cultures in gelatin without liquefaction.

(b) Growth in the form of a nail, which may be abundant or scanty, and more or less marked at the head of the nail (fig. 60).

(c) An arborescent, ramifying growth (fig. 61).

(d) A growth strictly limited to the surface (fig. 62).

2. Whether *liquefaction* occurs ; if so, note :

(a) The time when it is first observed.

(b) The form which the liquefaction takes, whether it be cylindrical, funnel-

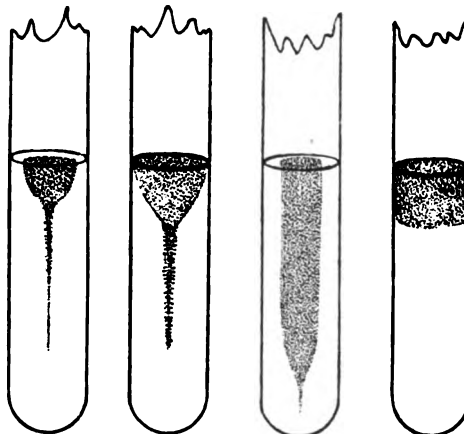

FIG. 63.—Cup-shaped liquefaction. FIG. 65.—Glove finger liquefaction.
FIG. 64.—Funnel-shaped liquefaction. FIG. 66.—Cylindrical liquefaction.

Gelatin stab cultures with liquefaction.

shaped, in the form of a glove finger or of a small cup (figs. 63 to 66). Note if an *air bubble* appears at the top of the growth.

3. The *colour of the growth*, and whether the growth itself or the medium around it is pigmented.

4. The *smell* of the culture.

SECTION V.—THE METHODS OF STORING CULTURES.

When growth has ceased, the organisms retain their vitality for a certain length of time varying according to the species from a few days to several months and even years, but ultimately they die and sub-cultures sown from them remain sterile.

The weakening and ultimate disappearance of vitality are in a large measure the result of the prolonged action of the oxygen of the atmosphere on organisms in an old culture medium, and which are not actively multiplying; to keep organisms alive therefore it is necessary to sow them from time to time on a new medium. But the same result is obtained by removing the organism, once growth has finished, from the action of the air; this may be done as follows:

1. Sow a broth culture, incubate it at the optimum temperature of growth until no further development of the organism takes place (the time required will obviously vary with different organisms).

2. Take a Pasteur pipette, and make a constriction just below the wool plug by heating it in the flame and drawing it out a little (*a*, fig. 67).

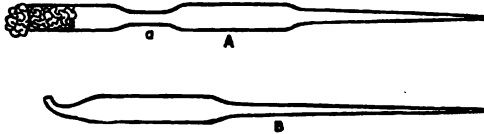

FIG. 67.—Method of sealing up a culture in a pipette.

3. When the pipette has cooled, dip the narrow end with the usual precautions into the culture and suck up the broth until it reaches the constriction *a*.

4. Seal the pipette both at *a* and at the other end as quickly as possible in the blow-pipe.

In this way a small tube is obtained, which is filled with the growth and sealed at both ends. This should be put away in the dark.

[In many cases when the tubes or flasks containing the culture are plugged with wool, it will be quite sufficient to pour melted paraffin wax over the wool and the lips of the opening in order to preserve the organisms alive for an indefinite period.]

CHAPTER . V.

THE ISOLATION OF AËROBIC MICRO-ORGANISMS IN PURE CULTURE.

Introduction.

Section I.—Mechanical methods, p. 76.

1. Dilution, p. 76.
2. Dissemination : (a) in liquefied solid media, p. 77 ; (b) on the surface of a solid medium, p. 81.

Section II.—Biological methods, p. 83.

1. Heat, p. 84.
2. Cultivation at the optimum temperature, p. 84.
3. Cultivation on special media, p. 85.
4. Animal inoculation, p. 85.

BEFORE a study of the morphology and biology of any micro-organism can be undertaken the organism must be obtained in pure culture, a culture, that is, free from all other organisms or as they are technically called *contaminations*. The first step, therefore, in a bacteriological investigation will be the preparation of a pure culture.

It is obviously impossible in view of their exceedingly small size to pick out individual micro-organisms and transfer them to tubes of culture media, so that resort has to be had to more complicated methods. There are numerous processes in everyday use for the isolation of organisms in pure culture ; for convenience of description these may be divided into two groups according as to whether in attempting to isolate an organism a purely mechanical method depending upon *dilution* and *dissemination* is relied upon, or whether advantage is taken of the *biological properties* of the organism.

The former, the **mechanical methods**, will be more useful when every species of organism present in a given material has to be isolated while the latter, the **biological methods**, are more especially applicable when a particular organism of which the chief characteristics are known beforehand has to be isolated from material in which it is suspected to be present.

Above all in attempting to isolate micro-organisms it is of the first importance to distinguish between *aërobic* and *anaërobic* species, for according as to whether the one or the other has to be isolated so the cultures will have to be grown in the presence or absence of air. In the case of anaërobic organisms the methods of isolation will be dealt with later (Chap. VI.). The present chapter is devoted entirely to the methods available for the isolation of aërobic micro-organisms.

SECTION I.—MECHANICAL METHODS.

1. Isolation by dilution.

This method was originally devised by Lister and extensively adopted by Nægeli and by Miquel, but is now of very limited application. It gives very exact results but occupies much time and is exceedingly tedious.

Suppose it be required to isolate the organisms present in a drop of water. Add the water to a tube A containing 10 c.c. of sterile broth. Thoroughly mix the water with the broth by shaking the tube. The organisms present in the drop of water are now diluted in 10 c.c. of broth, and since 1 c.c. corresponds to 20 drops, each drop of broth contains 20×10 , i.e. 200 times fewer organisms than the drop of water under investigation. Now transfer one drop of the mixture from the tube A to each of a series of tubes (B, B', B'', ...) containing broth. If the original drop of water contained 200 organisms, every drop of fluid in tube A will contain $\frac{200}{200} = 1$ organism, so that every drop transferred from A to the series B, B', B'', etc., will carry one organism, and that organism will grow in the tube B, B', or B'' to which it has been transferred and will give rise to a pure culture. But if the original drop of water contained only 50 organisms, then only one tube in four of the series B, B', B'', etc. will give rise to a pure culture. On the other hand, suppose the drop of water contained a larger number than 200 organisms, it will then be necessary to dilute further until in fact one drop contains not more than one organism. Thus 10 drops from A will be transferred to a broth tube B, and a series of sub-cultures C, C', C'', etc., will be sown, each with one drop of broth from B.

2. Isolation by dissemination.

The method of isolation by dissemination is due to Koch.

For its application the use of solid media is necessary. It may be carried out in one of two ways: either the medium may be liquefied and then sown, or the organisms may be distributed directly over the surface of the medium.

1. Dissemination in liquefied solid media.

If it be required to isolate all the organisms present in a drop of water, the method would be as follows: Transfer the drop of water to a tube of sterile gelatin previously liquefied in the water bath, and mix the water and gelatin thoroughly by rolling the tube between the hands. The organisms present in the water will now be distributed through the gelatin. Pour the gelatin in a thin layer on to a sterile glass plate, and cool it rapidly. The organisms will be scattered and held in the layer of gelatin like the almonds in a piece of nougat. If the plate be kept at a suitable temperature, each organism will grow in an isolated position, and will give rise to a colony composed of a number of micro-organisms all derived from the one organism which originally settled in that position, and therefore to a pure culture (fig. 68). It will then be easy to pick out each colony separately and sow it on a new medium.

There are in practice several ways of carrying this out, but the following rules must always be observed:

1. *After liquefying the gelatin or agar and before sowing it, let it cool sufficiently (to 30°-40° C.), to prevent the organisms being killed by the temperature of the medium.*
2. *Avoid contaminating the culture.*
3. *Protect the plates from dust.*

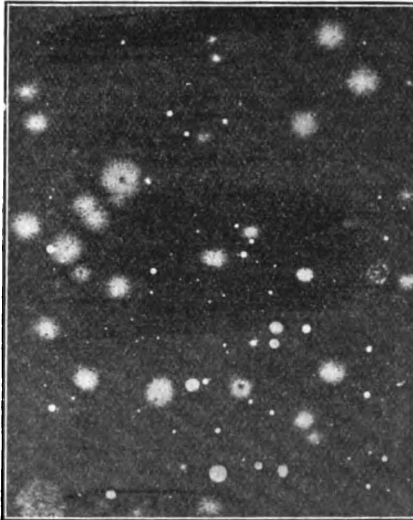

FIG. 68.—Isolated colonies of micro-organisms on a gelatin plate (two-thirds natural size).

A. Petri dishes. Method recommended.**(i) Using gelatin as the culture medium.**

Apparatus required.—(a) Three Petri dishes (fig. 43) wrapped in filter paper [or packed in a copper cylinder (Chap. I.)] and sterilized in the hot air sterilizer (a number of these dishes should always be kept ready sterilized).

(b) Three sterile Pasteur pipettes.

(c) Three tubes of sterile gelatin.

Technique.—1. Melt the gelatin by standing the tubes in the water bath.

Gelatin should never be liquefied by holding it in a gas flame, because the air dissolved in the gelatin will appear as bubbles in the substance of the medium and will interfere with the subsequent examination of the plates.

2. Take up a drop of the liquid to be examined in a Pasteur pipette and add it to one of the gelatin tubes (dilution 1), taking the necessary precautions to prevent contamination. Replace the wool plug and mix thoroughly by rolling the tube between the hands.

Never shake tubes of media as is done in chemical investigations, because it gives rise to frothing and this is highly inconvenient.

3. With another pipette transfer three drops from the first tube to another tube of gelatin (dilution 2). Mix as before.

4. Transfer three drops of dilution 2 to the third gelatin tube (dilution 3).

The three tubes of gelatin will now contain each a different number of organisms, and, according as to whether the original material contained many or few organisms, dilution 3 or dilution 1 will give the best results. Thus if the number of organisms be large, the colonies will be confluent in the plate poured with tube 1 and isolation will be impracticable; in that case dilutions 2 and 3 will be available.

5. Take out a Petri dish from its envelope. Take the plug out of the first gelatin tube, and flame the mouth. Then lift the cover of the Petri dish, pour the gelatin into it and cover the dish again as quickly as possible.

Spread the gelatin in an uniform layer over the surface of the dish by tilting it backwards and forwards, put it on a cold and level surface and allow it to set. Then label it and put it in the cool incubator (20° C.).

6. Pour plates with the gelatin in tubes 2 and 3 in the same way.

7. Examine the plates every day, and without lifting the cover note the appearance of the colonies and their characteristics (both with the naked eye and with the aid of a lens). Remove a portion of each colony for the purpose of making sub-cultures and for microscopical examination.

Roux bottles.—It is often more convenient to use a flat flask, such as Roux's (fig. 69), instead of Petri dishes. The flasks are perhaps better than the Petri dishes because they effectually prevent contamination of the medium and evaporation is reduced to a minimum.

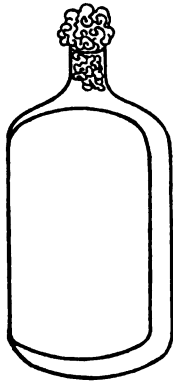

FIG. 69.—Roux bottle.

Note.—The gelatin plate method has some disadvantages, and is not available in all cases. Thus :

(a) Some organisms rapidly liquefy gelatin, and if such are present in the material under investigation the experiment is liable to be a failure.

(b) It is only applicable in cases of organisms growing at temperatures below 25° C. Above this temperature gelatin ceases to be a solid medium.

(ii) Using agar as the culture medium.

Consequently, agar plates are sometimes used, especially when pathogenic micro-organisms are being investigated. The technique is essentially the same as in the case of gelatin plates, but the following points must receive attention.

1. Agar only melts between 90° and 100° C. and does not set again until it cools to 40° C. The agar tubes will therefore have to be melted in boiling water and then allowed to cool until they can be comfortably held in the hand.

2. The tubes must be sown as above, but the experiment must be done quickly otherwise the agar will begin to solidify and the plates will be lumpy.

It is a good plan to have the Petri dishes standing on a levelling apparatus filled with water at 40°–45° C. (see below) before pouring the agar, and to cool the plates slowly in order to prevent the formation of lumps at the time of cooling in the dishes.

3. Incubate the plates at 37° C. The plates should be packed into a large glass dish containing a few pieces of filter paper soaked in water [or perchloride solution] to prevent the medium drying up.

Agar gelatin may be used for cultures which are to be incubated between 25° and 35° C.

This agar plate method never gives very good results, and when agar has to be used for isolating organisms it is much better to employ surface cultures (*vide infra*).

B. Koch's plates.

The use of Koch's plates constitutes an ingenious method of isolating micro-organisms, but the technique is complicated and difficult to carry out under strictly aseptic conditions for the following reasons:

1. The plates must necessarily be exposed to the air for a few seconds while being manipulated, and so are liable to contamination; but if they be prepared quickly and in a still atmosphere, with no dust blowing about, this exposure is not of much moment.

2. In examining the plates, it is also necessary to lift the cover of the moist chamber and so again expose the medium to contamination from the air; the experiment is thus open to error.

The technique of the method is as follows:

Apparatus required.—1. Three glass plates (9 × 12 cm.) each wrapped up separately in paper and sterilized in the hot air sterilizer (a number of these plates should

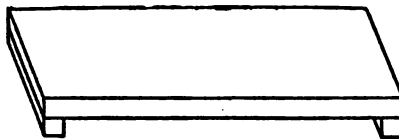

FIG. 70.—Glass support for plate cultures.

always be at hand ready for use). [As in the case of Petri dishes, some bacteriologists prefer to sterilize the plates in metal cases.]

2. Three glass supports on which to rest the plates (fig. 70).

3. Two large circular glass dishes, each about 20 cm. in diameter but one rather larger than the other so that they can be fitted together to form a box.

4. A cooling table consisting of a flat metal box the top of which is well polished

and covered by a bell jar (fig. 71). The table rests on screws which enable it to be levelled with the aid of a small spirit level. Two lateral tubes fitted to the box allow a stream of cold water (or if agar is being used, warm water) to be passed through it, and ice can also be put into the box if necessary through a large opening in the bottom closed with a screw cap.

5. Three tubes of melted gelatin and three Pasteur pipettes.

Technique.—1. Pour a little perchloride of mercury solution into the large glass dish, and by rotating the dish wash every part of its interior with the antiseptic.

Lay two or three thicknesses of filter paper in the bottom of the dish and saturate

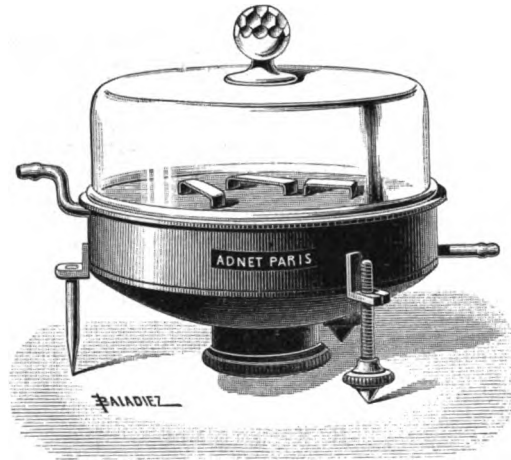

FIG. 71.—Cooling stand for plate cultures.

them with perchloride solution. (This constitutes a *moist chamber*, the object being to prevent the gelatin plates drying up.)

Wash the glass stands (fig. 70) with perchloride, and place one of them in the bottom of the dish.

2. Place the cooling stand on the operator's left, level it and fill it with cold or iced water. Wipe the top carefully to remove any dust that may be on it, and wash the inside of the glass cover with perchloride solution.

3. Sow the three tubes of gelatin, 1, 2, and 3, as in the gelatin plate method (p. 78 A (i)).

4. Take one of the glass plates, tear off the paper cover along one of the edges, hold it by one of its corners between the thumb and first finger of the right hand [or better in a pair of sterile forceps], slightly raise the glass cover with the left hand, and lay the plate on the glass support already placed there. Replace the glass cover.

5. Take the plug out of tube 3, flame the upper 2 or 3 cm. of the tube, and then while not raising the glass cover more than is necessary introduce the mouth of the tube beneath it, pour the gelatin on to the centre of the glass plate and spread it with the upper flamed part of the tube. Withdraw the tube, replace the bell jar, and allow the gelatin to set.

6. When the gelatin has set, raise the bell jar again, take hold of the glass plate by one of its corners, transfer it as quickly as possible to the moist chamber (the cover of which is raised with the left hand, after replacing the bell jar), and lay it on the glass stand.

Bridge the glass plate with the second glass stand, and replace the cover of the moist chamber.

It will be noticed that the gelatin has not come in contact either with the walls

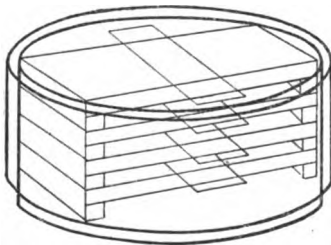

FIG. 72.—Arrangement of the glass plates in a moist chamber.

of the moist chamber or with the glass stands, and this explains why perchloride can be used for sterilizing these pieces of the apparatus.

7. In the same way pour a plate with tube No. 2, place it in the moist chamber, and put the third glass support in position.

8. Repeat the process with tube No. 1, and place it on the third plate-rest.

9. Put the moist chamber in the incubator at 20° C. The plates have been arranged so that the one containing the largest number of organisms is nearest the top of the chamber. Colonies will appear on it earlier than on the other plates, and it can be examined and studied without touching the latter, which should not be interfered with until growth appears on them.

C. Esmarch's tubes.

Apparatus required.—1. Three Pasteur pipettes.

2. Three tubes of gelatin. The tubes should be rather longer and wider than ordinary culture-tubes, and each should contain 10 c.c. of sterile gelatin.

3. Three sterile india-rubber caps.

Technique.—1. Sow the tubes 1, 2, and 3 as before (p. 78 A (i)).

2. Slip an india-rubber cap over the wool plug of each.

3. Cool each tube in turn under the cold water tap: hold it as nearly horizontally as possible, so that the gelatin coats the whole of the inner surface of the tube below the plug (but without touching the wool), and rotate it between the index finger and thumb of each hand. When the gelatin sets it is thus spread in a thin layer over the whole of the inner surface of the tube and forms a "roll" tube.

4. When the gelatin has set, take off the india-rubber cap and incubate the tubes at 20° C.

This method has the great advantage of absolutely preventing any contamination of the medium, but the investigation of the colonies which develop is rendered more difficult by the cylindrical shape of the gelatin surface.

2. Dissemination on the surface of a solid medium.

When it is necessary to isolate the organisms present in a non-liquid product such as a false membrane, viscous sputum, etc., a small portion of the material is smeared over the surface of some solid medium contained in a Petri dish or sloped in a tube. This, which is the method now universally adopted for the isolation of diphtheria bacilli from false membranes, is available when the media which it is proposed to use cannot be liquefied by heat, *e.g.* potato or serum.

If there be reason to suppose that the material under investigation is very rich in organisms (excreta, for example), a small portion is diluted in a few cubic centimetres of broth or sterile water and a trace of the dilution used for sowing cultures.

Two methods are available.

A. Stroke cultures.

The method of isolation on agar plates will be taken as an illustration (fig. 73).

Apparatus required.—1. A medium or stout platinum wire.

2. A tube of agar.

3. A sterile Petri dish.

Technique.—1. Melt the agar and pour it with the usual precautions into the Petri dish.



FIG. 73.—Isolation of organisms by parallel stroke culture on Petri dishes. $\times \frac{1}{24}$.

Let the agar set firmly.

2. Take up a trace of the material under investigation on the wire, raise the cover of the Petri dish, and without recharging the needle make a series of parallel strokes on the agar each a few millimetres distant from the other.

As the needle is drawn over the agar the material on it is transferred to the latter, and it is obvious that after the wire has been drawn across the agar three or four times the number of organisms left along the line of any stroke will be but few in number.

3. Incubate the plate at 37° C. The colonies which develop along the first strokes will be very numerous, but will be fewer and fewer along the later ones.

B. Surface cultures.

1. **Classical method.**—This method of isolation may be illustrated by describing it as it would be used with sloped serum, but the method is the same for agar, potato, etc.

Apparatus required.—1. A stout platinum wire flattened at the end.

2. Three tubes of sloped solidified serum.

Technique.—1. Take up a trace of the material under investigation on the wire.

2. Remove the plug from one of the serum tubes, dip the needle into the tube and smear the whole surface of the medium, commencing below and working towards the mouth (tube 1).

3. Without recharging the needle sow a second tube of serum in the same way (tube 2).

4. Sow the third tube similarly, again without recharging the needle (tube 3).

5. Incubate the tubes at 37° C.

As the result of drawing it over the surface of the serum, the needle is gradually wiped clean of the organisms with which it was charged and which have been deposited on the serum. Tube No. 1 will grow numerous confluent colonies, but tubes No. 2 and No. 3 will grow fewer colonies and some of them will be well isolated. The discrete and isolated colonies on the latter tubes can be used for further investigation.

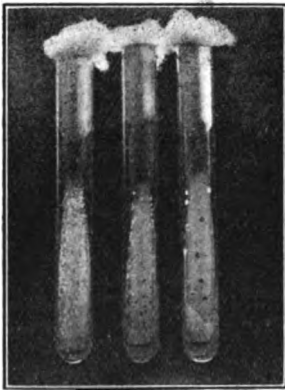

FIG. 74.—Isolation of organisms by Veillon's method.

2. **Veillon's method.**—1. Take a trace of the material on a platinum wire.

2. Without recharging it, dip it into the water of condensation at the bottom of 4 or 6 agar tubes.

3. Replug the tubes and sow the surfaces of the agar by running the water of condensation over them. Incubate the tubes in the vertical position.

3. **Chantemesse's method.**—This is useful for the purpose of isolating organisms present in stools.

1. Dilute a trace of the material in several cubic centimetres of distilled water.

2. Dip a sterile badger-hair pencil into this highly diluted material.

3. Brush the surface of a series of 5 or 6 agar plates (prepared in Petri dishes as described above under A, p. 81) without recharging the brush.

4. Incubate the plates at 37° C.

Chantemesse adopts this method in isolating the typhoid bacillus, using a special medium instead of agar (Chap. XXI.).

[4. Burri's method.]—The aim of the method is to grow a colony from a single organism. A dilute emulsion of the organism is made and further diluted in an emulsion of indian ink; small drops of the latter are then laid on the surface of gelatin, covered with a cover-glass and examined under the microscope. Those cover-glasses which cover only a single organism are then transferred to other media and incubated.

[Apparatus required.]—1. A sterile emulsion in water of commercial indian ink,¹ or better a 1 in 9 emulsion in water of a colloidal compound known as Pelikan Tusche No. 54.²

2. A number of sterile Petri dishes, slides and cover-glasses.

3. Half a dozen ready poured gelatin plates in large Petri dishes.

4. Sterile dissecting forceps.

5. Two or three fine drawing pens also sterilized.

[Technique.]—1. Prepare a dilute and homogenous emulsion in normal saline solution of the culture or material under examination.

2. Place a sterile slide in one of the Petri dishes; with a small platinum loop put four drops of the indian ink emulsion in a row on the slide and replace the cover of the dish.

3. With a straight platinum wire transfer a small drop of the bacterial emulsion to the left-hand drop (No. 1) of the indian ink on the slide and mix intimately. Transfer similarly a small drop from No. 1 to No. 2 and mix; from No. 2 to No. 3 and so on.

4. With one of the sterile drawing pens take up the right-hand drop of bacterial-indian ink emulsion and lay it in a series of very minute droplets on the surface of one of the gelatin plates. Cover each drop separately with a sterile cover-glass.

5. Disseminate similarly drop No. 3 on another plate and cover as before.

6. Examine the droplets under the microscope using a dry lens and an high eyepiece. If necessary an oil immersion lens may be used; in that case place a drop of oil on the upper surface of the cover-glass. The organisms will be seen as bright objects on a dark background.

7. When a droplet is found in which only a single organism is suspended, raise the cover-glass with a pair of sterile forceps—the indian ink and organism will be found to adhere to the cover-glass—and transfer it to another plate of gelatin or some other suitable medium laying the cover-glass drop side downwards. Incubate.]

SECTION II.—BIOLOGICAL METHODS.

The methods now to be described are only available when the detection and isolation of a given organism is in question, and depend upon a knowledge of one or more properties of the organism; this knowledge is applied to facilitate the growth of that organism while at the same time hindering the growth of any others which may be present.

The separation of anaërobic from aërobic organisms may be quoted as an example of the principles involved. Aërobic organisms cannot grow in the absence of free oxygen; so that by sowing the material in an atmosphere free from oxygen cultures of anaërobic organisms alone are obtained.

The methods most generally in use will be described.

¹ Günther, Vienna.

² Grübler, Leipzig.

1. The application of heat to the isolation of micro-organisms.

Spore-forming organisms can resist temperatures of 80° to 100° C. and even 105° C. for several minutes, but non-spore-bearing organisms are soon destroyed when heated to about 60° C. Hence it will be easy to separate a spore-bearing from a non-spore-bearing organism in a mixture containing both; it will only be necessary to heat the mixture for a few minutes to a temperature between 80° and 105° C., according to the resistance of the spore, and subsequently to sow it in a tube of broth. Thus a pure culture of the anthrax bacillus can be obtained by heating an impure culture to 80°–85° C. for 5 minutes.

An infusion of hay if heated to 100° C. for 10 minutes will give a pure culture of the *Bacillus subtilis*. Similarly an infusion of potato chips incubated for two or three days and then heated to 105° C. for 5 minutes will give a pure culture of the potato bacillus, and so on.

In carrying out the above experiments, it is necessary to work with fluid cultures or suspensions, since organisms when dried or mixed with solid matter are much more resistant to heat. It is further essential to the success of the method that all parts of the culture fluid be raised to the required temperature, otherwise some of the non-sporing forms will escape destruction and the experiment will be only a partial success.

The technique is as follows :

1. Prepare a very fine Pasteur pipette with a constriction below the wool (p. 75).
2. Fill the pipette with the culture up to the constriction and seal both ends in the flame.
3. Immerse the tube in a water bath heated to the temperature required, and leave it for 5 or 10 minutes. If the temperature required be above 100° C. the tube must be heated in the autoclave.
4. Dry the tube and then break off one end with a pair of sterile forceps after passing it through the flame. Withdraw a little of the fluid into another sterile pipette, being careful to avoid contaminating it, and sow sub-cultures.

2. Isolation by cultivation at the optimum temperature.

Fractional cultivation.

While some organisms will grow at any temperature between 10° and 40° C., the limits of temperature within which growth takes place are in the majority of cases much more restricted. Thus a large number of saprophytes grow slowly and poorly above 30° C.; many of the pathogenic bacteria attain their maximum development between 30° and 40° C., others will not grow below 30° C., while yet another group (the typhoid-colon group) grows at 43° C.—a temperature which is too high for the multiplication of most micro-organisms. These facts with regard to differences in the optimum temperature at which micro-organisms grow are applied for the purpose of isolating organisms in pure culture.

For example, the colon bacillus can be isolated from stools by sowing a trace of the material in broth and incubating at 43° C. Incubation at this temperature however does not at once yield a pure culture, for the organisms which were present with the colon bacillus in the original material have not been destroyed but their growth merely arrested; so that were a sub-culture to be sown from this first broth culture and incubated at 37° C. these co-existing organisms would multiply under the more favourable conditions and contaminate the culture of the colon bacillus. To eliminate them the method of **fractional cultivation** may conveniently be adopted; thus when the first

broth culture incubated at 43° C. has become cloudy a trace of it is sown in another tube of broth which is then similarly incubated at 43° C., and from the second tube a third is sown, and so on, until after several sub-cultures in series, each incubated at 43° C., a pure culture of the colon bacillus is ultimately obtained.

A method analogous to this is employed when it is required to isolate the cholera vibrio from specifically infected stools, only in this particular case the action of temperature (37°-38° C.) is combined with that of a special medium (*vide infra*) in which fractional cultivation is effected. This will be found to be in most cases quite a useful method for eliminating saprophytic organisms.

3. Isolation by cultivation on special media.

The growth of any given organism to the exclusion of that of others which are present with it may be effected by sowing the material on a medium which is designed to meet the requirements of the organism to be isolated.

The diphtheria bacillus, for instance, can be isolated in pure culture by smearing the surface of a number of serum tubes with a piece of membrane. Isolation in this case is favoured by the fact that serum is very well adapted to the growth of the diphtheria bacillus, but more or less unfavourable to the multiplication of organisms which are generally found associated with this bacillus.

For the isolation of the cholera vibrio, Koch and Metchnikoff recommend special media which though of poor nutritive value happen to meet its particular requirements. Thus a trace of the "rice water" stool is sown in a tube of Metchnikoff's liquid peptone-gelatin medium (p. 33) and incubated at 38° C. Under these circumstances the growth of the cholera vibrio is much more rapid than that of the other organisms present. The vibrio being a very strictly aerobic organism forms a pellicle on the surface of the liquid, and if after the culture has been incubating for 12 hours or so, a trace of the film be examined, it will be found to consist of an almost pure culture of the cholera vibrio. To further purify the culture recourse must be had to fractional cultivation [sowing the sub-culture with a trace of the pellicle taken up on the point of a fine wire], and three passages will be all that is necessary before finally plating out on gelatin as described on p. 78.

[For the isolation of bacilli of the typhoid-colon group MacConkey has introduced bile-salt media. The material suspected to contain the organism is sown in a liquid bile-salt medium, and after incubation, preferably at 42° C., a trace of the culture is plated out on a bile-salt-agar and suspicious colonies picked off for further examination (for fuller details of the method, see Chaps. XXI. and XXIII.)]

Finally, in some cases, the growth of associated organisms may be arrested by adding to the medium some antiseptic which is not injurious to the organism to be isolated. Chantemesse for instance advises the use of media containing carbolic when attempting the isolation of the colon or typhoid bacillus, and Elsner suggests the use of potassium-iodide-gelatin for the same purpose.

As has been indicated above, this and the method of cultivation at the optimum temperature may be combined; Vincent for instance adopted a combination of the two methods in his attempts to isolate the typhoid bacillus (Chap. XXI.).

4. Isolation by animal inoculation.

In some cases the simplest, and perhaps the only, method of isolating a pathogenic organism in pure culture from material in which it is mixed with

non-pathogenic species will be to inoculate the material into a suitable animal.

For example, to isolate the pneumococcus from pneumonic sputum a little of the latter may be inoculated beneath the skin of a mouse ; the animal will soon die and its blood will be found to contain a pure culture of the pneumococcus.

Similarly, to isolate the bacillus of malignant œdema from soil in which there is also present a large number of other organisms, a little of the earth is rubbed up into a thin emulsion in a few drops of sterile water and inoculated beneath the skin of the abdomen of a guinea-pig. The animal dies from an infection known as Pasteur's septicæmia, and the serous peritoneal exudate will contain the bacillus in pure culture.

Many opportunities of studying this method of isolating organisms will occur later.

CHAPTER VI.

THE CULTIVATION AND ISOLATION OF ANAËROBIC MICRO-ORGANISMS.

Introduction.

Section I.—The methods of abstracting air from culture media, p. 87.

1. By boiling, p. 87.
2. By displacing the air with some inert gas, p. 88.
3. By absorbing the oxygen, p. 89.
4. By the use of a vacuum, p. 90.

Section II.—The cultivation of anaërobic organisms, p. 92.

1. Liquid media, p. 92.
2. Solid media, p. 99.

Section III.—The isolation of anaërobic organisms, p. 101.

1. Plate method, p. 101.
2. Tube method, p. 103.

Section IV.—Vacuum incubators, p. 104.

SOME organisms grow equally well under both aërobic and anaërobic conditions, others grow only when the medium in which they are sown contains no trace of free oxygen; the former are known as the facultative anaërobes, the latter as the strict anaërobes. The cultivation of the strictly anaërobic organisms is accompanied by certain technical difficulties arising out of the necessity for removing all traces of air from the culture medium in which they are sown. The culture media are the same for the two classes, but for the strictly anaërobic organisms special forms of culture apparatus and special methods are required, and it is to a description of these that the present chapter is devoted.

The recent investigations of Tarrozzi, which have been confirmed by Wrzosek, Guillemot, Ori and others, seem to show that oxygen does not directly exert any harmful influence on anaërobic organisms, but that the presence of free oxygen prevents the media furnishing the nutritive substances necessary for anaërobic life.

Anaërobic organisms can in fact, as Tarrozzi has shown, be grown in presence of the oxygen of the atmosphere by simply adding pieces of animal tissue or some reducing agent to the culture media (*vide infra*).

SECTION I.—METHODS OF ABSTRACTING AIR FROM CULTURE MEDIA.

1. By boiling.

Gases dissolved in a liquid can be expelled by boiling. To expel all the air from a culture medium it must be boiled for 20 minutes to half an hour, and then be cooled rapidly away from the air.

2. By displacing the oxygen of the atmosphere by an inert gas.

The air in a liquid can be displaced by passing a current of an inert gas through it. Hydrogen, carbonic oxide, nitrogen and ordinary coal gas have all been suggested for the present purpose.

A. Hydrogen.—For the growth of anaerobes, hydrogen is preferable to the other gases mentioned. Not only is it easily prepared, but it has no injurious effect on the organisms.

A convenient form of apparatus for readily obtaining a continuous supply of hydrogen is that illustrated in fig. 75. The bottle A contains a 1 in 6

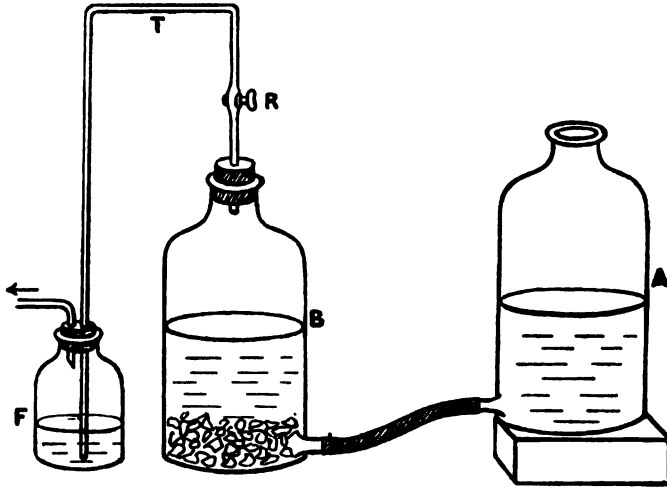

FIG. 75.—Apparatus for yielding a continuous supply of hydrogen.

solution of pure sulphuric acid in water. The bottle B contains some pieces of broken glass at the bottom, and above this a layer of granulated zinc. By simply raising the bottle A and opening the tap R a stream of hydrogen will issue from the tube T; similarly, by closing the tap R and lowering A to the level of B the supply is stopped. To remove impurities, especially oxygen, it is desirable to wash the hydrogen as it issues from the bottle B by passing it through the following solution:

| | | | | | |
|--|---|---|---|---|---------|
| Caustic potash, 50 per cent. in water, | - | - | - | - | 50 c.c. |
| Pyrogallol, | - | - | - | - | 1 gram |

contained in a wash-bottle F.

It is even better to have two wash-bottles, one containing a solution of potassium permanganate slightly acidified with sulphuric acid, the other a solution of potassium permanganate made slightly alkaline with caustic soda. These solutions must be frequently renewed. The method is particularly useful for removing traces of hydrocarbons and phosphides and arsenides of hydrogen.

The hydrogen before being passed through the culture medium should be tested by means of indigo white, to ascertain that it is quite free from traces of oxygen (p. 92).

[Hydrogen is, however, most conveniently obtained by keeping a cylinder of the compressed gas in the laboratory. Cylinders of the gas can be obtained

in commerce guaranteed to contain 99·6 per cent. of hydrogen, the remaining 0·4 per cent. being almost if not entirely composed of air, which represents 0·08 per cent. of oxygen. When used for the cultivation of anaërobic organisms in a Bulloch's apparatus (pp. 96 and 100)—which is the method usually adopted in England—the gas requires no preliminary washing, but is passed direct from the cylinder into the bell jar containing the cultures.]

B. Carbonic anhydride.—Carbonic anhydride is harmful to a large number of organisms, and its use for that reason is not to be recommended in the present connexion. The apparatus described above for the preparation of hydrogen can be utilized for the preparation of the gas, if pieces of white marble be substituted for the zinc, and hydrochloric acid for the sulphuric acid. The gas should be washed by passing it through a solution of sodium hydrosulphite contained in the wash-bottle F (fig. 75).

C. Nitrogen.—The preparation of this gas is so difficult that its use should be abandoned in practical bacteriology. [Nitrogen can however now be obtained as a commercial product in the form of cylinders of the compressed gas, which on analysis is found to contain very little oxygen. In our experience the results obtained with this compressed gas in the growth of anaërobic organisms have been quite satisfactory.]

D. Coal gas.—The use of coal gas is not to be recommended in anaërobic methods, because many of the component gases comprising the mixture are inimical to micro-organisms.

Note.—Before passing any gas into a culture medium it must be sterilized by filtration through a sterile cotton-wool plug. The technique of this operation will be referred to later.

3. By absorbing the oxygen.

A. Advantage may be taken of the affinity possessed by some substances for combining with oxygen to remove the latter from culture media. In practice oxygen is generally absorbed by resting the culture-tube on a glass, or metal, support inside a much larger tube (about 20 to 25 cm. in length), and then pouring the following solution into the latter :

| | |
|-----------------------------|----------|
| Pyrogallol, - - - - - | 1 gram. |
| Alcoholic potash, : : : : : | 1 |
| Water, - - - - - | 10 c.c." |

Plug the outer tube with a tightly-fitting india-rubber bung. Under these conditions oxygen diffuses through the wool plug of the inner culture-tube and, being absorbed by the pyrogallol, turns the solution brown.

Sellards, using a similar apparatus, substitutes fragments of phosphorus for the potassium pyrogallate solution.

B. In some cases it will be found convenient to add to the medium some easily oxidizable substance, which does not interfere with the growth of the organism; e.g. glucose (2 per cent.), formate of soda (0·5 per cent.), sodium sulphindigotate (0·1 per cent.), fragments of tissue, etc. This method is generally adopted in the case of deep stab cultures in agar (*vide infra*).

C. By sowing the surface of an anaërobic culture in a solid medium with some aërobic organism which absorbs a good deal of oxygen, air can be prevented from reaching the anaërobic culture, the growth of the latter taking place beneath the growth of the aërobic organism (Roux). This method will be described in detail when dealing with stab cultures.

4. By the use of a vacuum.

The use of apparatus by means of which a vacuum can be produced simplifies the methods of cultivating anaerobes and at the same time renders them more exact; and moreover, as both a mercury pump and water pump are in everyday use in the laboratory, the essentials are ready to hand. The use of a vacuum is generally supplemented by washing with an inert gas; by the combination of the two methods it should be possible to remove all trace of oxygen from the culture vessels.

In many laboratories the further precaution is taken of adding some oxygen-absorbing solution, generally pyrogallol and potash, to absorb any traces of oxygen which might still remain.

The reason for washing with an inert gas lies in the physical fact that two gases, which do not enter into chemical combination, rapidly diffuse when brought in contact and form an uniform and constant mixture. The rate of diffusion varies directly as the differences in density of the gases; the greater the difference the more rapid the diffusion.

In practice it is impossible to obtain a perfect vacuum, so that after exhausting a vessel full of air a residuum of air remains. Now if the vessel be filled with hydrogen and exhausted again the residuum will consist of a mixture of air and hydrogen; by repeating the process several times, the amount of air ultimately present will be infinitesimal in amount.

Suppose that after exhausting a vessel of 2 litres' capacity there remains 1 c.c. of air measured at atmospheric temperature and pressure; fill the vessel with hydrogen, and the 1 c.c. of air will be diluted 1 in 2000; exhaust again until only 1 c.c. remains, and the residual gas will contain $\frac{1}{2000}$ c.c. of air and $\frac{1999}{2000}$ c.c. of hydrogen; after a second washing with hydrogen the volume of air will not exceed $\frac{1}{4,000,000}$ c.c.

A. Mercury pump.—With this apparatus an almost perfect vacuum can be obtained, but it is expensive and being delicate is liable to be easily damaged; moreover time and skill are required to use it to the best advantage. Its use is limited in practice to very delicate investigations and to vessels of small capacity. Without going into the details of the working of the pump the following points of importance in connexion with its use may be noted.

1. The pump must always be tested to see that it is working properly and that the taps fit well. Any taps not fitting tightly must be lubricated.

2. Connect the vessel containing the culture to the pump, and exhaust until there is a wide difference between the levels of the mercury in the two limbs of the manometer.

3. Then open the tap connected to the hydrogen supply just a little, and let the hydrogen pass slowly into the receiver until the mercury has reached its original position.

4. Turn off the supply of hydrogen. Exhaust again, and repeat the process two or three times.

5. Seal the neck of the culture vessel in the flame *in vacuo*.

B. Water pump.—On account of its moderate price and of the ease with which it is worked, a water pump is much more often used for producing a vacuum than a mercury pump. The vacuum is only approximate, and exhaustion with a water pump must therefore be combined with washing with an inert gas.

The pump, which is best made of metal (d'Alvergniat's pattern), should

consist of a copper pipe fitted with a manometer M and joining the pump proper at a right angle T, as shown in the figure (fig. 76).

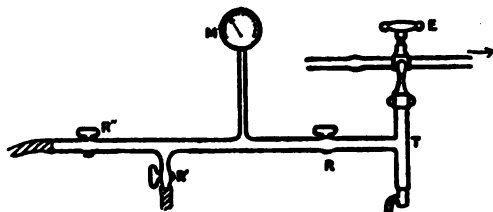

FIG. 76.—A water pump with its fittings.

A water-pressure of about two atmospheres is necessary. The method of exhausting and washing is as follows :

1. By means of pieces of thick-walled rubber tubing (pressure-tubing), connect the vessel containing the culture to the tap R', and the hydrogen-generating apparatus to the tap R'.

Close the taps R and R', leaving R' open throughout the experiment.

2. Turn on the water tap E, gradually open R, and watch the manometer needle.

3. When the vessel has been exhausted as completely as possible, close R, and by gradually opening R', fill the culture vessel with hydrogen.

4. When the manometer needle has fallen to zero, close R', open R again, and exhaust the vessel a second time.

5. After exhausting and washing with hydrogen two or three times, seal the neck of the culture vessel in the flame *in vacuo*.

It is not always necessary to wash with hydrogen, but if exhaustion alone be relied upon the culture liquid should be boiled ; this can easily be done by very slowly raising the temperature to 30°-35° C. either by holding the vessel in the hand or by standing it in a vessel of luke-warm water or by heating it with a small flame.

Note.—In using a water pump the tap R must be closed, so as to cut off all connexion between the water and the

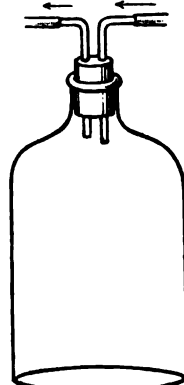

FIG. 77.—Wash-bottle fitted up for use with a water pump to prevent backflow of water into the culture medium.

culture, before turning off the water tap at the end of an experiment. If this precaution be omitted, the vacuum will induce a violent rush of water into the culture vessel.

A similar inrush of water will also occur if from any cause whatever the pressure in the main is suddenly lowered during the process of exhausting ; consequently a bottle of 2 or 3 litres' capacity, and fitted up as shown in fig. 77, should always be interposed between the pump and the vessel to be exhausted.

If then there be a rush of water, it will collect in the bottle and will not contaminate the culture. It is even better to use a pump fitted with a brass reservoir (fig. 78),

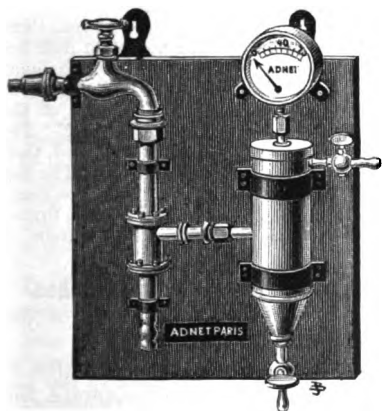

FIG. 78.—Water pump with safety reservoir.

which will act in the same way as the bottle and prevent a rush of water into the culture. The only ground of objection to this piece of apparatus is that of cost.

Tests for oxygen.

It is often necessary to know whether a gas—the hydrogen used in washing anaerobic cultures, for instance—is free from oxygen. This may be determined by passing the gas through a solution of indigo white, a substance which turns blue in presence of small quantities of oxygen.

Indigo white is prepared by treating indigotine (pure indigo) with concentrated sulphuric acid. This solution when neutralized with sodium carbonate gives sodium sulphindigotate, which in presence of an excess of alkali is easily decolourized by reducing agents. Sodium sulphindigotate is generally reduced with sodium hydrosulphite, obtained by adding to powdered zinc a concentrated solution of sodium bisulphite saturated with sulphurous anhydride. Sodium hydrosulphite is a powerful reducing agent and decolourizes the indigo, combining with the oxygen of the atmosphere to form bisulphite.

The gas may therefore be tested for oxygen by bubbling it, away from air, through a solution of indigo white.

To make sure that a culture medium contains no free oxygen, a few drops of a 0.2 per cent. solution of sulphindigotate of sodium may be added until the colour is distinctly blue, then 1 per cent. by weight of a normal soda solution and 1 per cent. of glucose. When all the free oxygen has been removed the blue colour disappears, the glucose reducing the indigo under these conditions.

If a culture medium tinted with a few drops of a solution of sodium sulphindigotate be sown with an anaerobic organism and freed from oxygen, the blue colour will be destroyed as growth of the organism proceeds, decolourization commencing in the immediate neighbourhood of the colonies. The micro-organism takes the oxygen necessary for its growth from the substances around it, and acts therefore as a reducing agent.

SECTION II.—THE CULTIVATION OF ANAEROBIC ORGANISMS.

1. Liquid media.

A. Pasteur's method.—This is the method originally employed in growing anaerobic organisms. It is now only of historical interest.

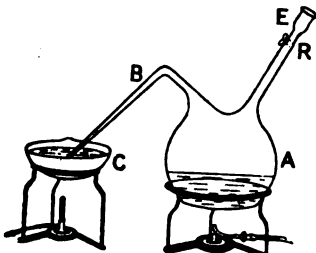

FIG. 79.—Pasteur's original method for the cultivation of anaerobic organisms.

A large round flask A (fig. 79) with two tubulures is filled with broth: the tubulure B dips into a porcelain dish three-parts filled with the same liquid. The tap R being closed, the flask and porcelain dish are simultaneously heated to boiling for half an hour. The dissolved air is thus driven off. The apparatus is allowed to cool *in situ*, and then the end of the tube B is transferred to a vessel full of mercury. The funnel E is filled with carbonic acid gas, and then (away from air) with the fluid to be sown. The tap R is next opened and the fluid runs into the flask, care being taken that a little remains in the funnel to prevent access of air to the flask. The culture is then incubated.

B. Roux's pipette. Method recommended.—

1. Make a constriction in a sterile Pasteur pipette in a small flame of the blow-pipe just below the cotton-wool plug (fig. 67 a, p. 75).

2. After flaming the point of the pipette, break it off, dip it into a tube of broth already sown with the organism to be cultivated and aspirate the broth into the pipette until the latter is three-parts full.

3. Tilt the pipette so as to raise the point and seal the latter in a small flame.

4. Connect the other end to an exhaust pump. Exhaust and wash with hydrogen alternately.

It is often sufficient when a vacuum is established to boil the liquid as described at p. 91. When the pipette is heated even very slightly the liquid will boil violently and will tend to pass into the aspirating tube; this may be prevented by first heating the upper part of the tube above the liquid.

5. Seal the pipette at the constriction *a*, *in vacuo*. Dip the ends of the pipette into Golaz's wax to strengthen them. Incubate.

6. When the culture has grown, flame and break the end *a* of the pipette and withdraw the culture by means of a Pasteur pipette.

C. Pasteur, Joubert and Chamberland's tube.—With this apparatus two successive cultures can be sown without exposing the medium to the air while sowing the second culture.

It consists (fig. 80) of an inverted U-tube, each limb of which is provided with a lateral tubulure terminating in a fine point. A third tubulure originates from the convexity of the U, and this is constricted in two places a short distance apart, and plugged with wool between the two constrictions.

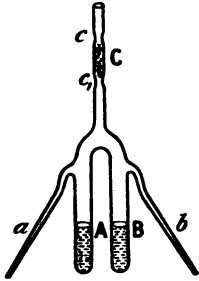

FIG. 80.—Pasteur, Joubert and Chamberland's tube for the cultivation of anaërobic organisms.



FIG. 81.—Pasteur's tube for the cultivation of anaërobic organisms.

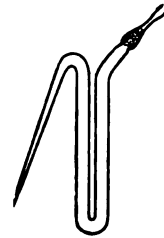

FIG. 82.—Lacomme's tube for the cultivation of anaërobic organisms.

1. Plug the vertical part C with wool between the constrictions *c* and *c*₁, seal the points of the lateral tubulures *a* and *b* and sterilize the tube in the hot air sterilizer.

2. When it has cooled, flame the lateral tube *a*, break off its point and dip the latter into the broth, which has been sown beforehand. Aspirate the liquid into the limb A by applying suction to C. Seal up the end of *a* in the flame again.

3. Flame the lateral tube *b*, break off its point, dip the end into a tube of sterile broth, and aspirate the broth into the limb B. Seal the end of *b* in the flame.

Note.—In carrying out the second and third operations, be careful that the liquids in the two limbs do not mix. The limbs should not be more than one-third filled.

4. Attach the upper end of C to the exhaust pump. Exhaust the air, and wash two or three times with hydrogen. Seal the tube at the constriction *c in vacuo*.

5. Incubate the tube in the vertical position. Growth will occur in A, while the broth in B will remain clear and serve as a control.

6. When growth in A has ceased, tilt the apparatus so that a drop or two of the culture passes from A into the sterile broth contained in B. Incubate again, and growth will now take place in B.

D. Pasteur's tube.—This is a more simple form of the preceding, and consists of a single limb of the U-tube just described (fig. 81).

After sterilizing the tube aspirate the broth, already sown with the organism, through the narrow tube *a*, seal the point of *a* in the flame, exhaust through B, seal this tube at *b* and incubate.

Lacomme's tube (fig. 82) is a modification of Pasteur's; it is used in an exactly similar manner, and is cheaper.

E. Long-necked flask method.—This is a useful method when large quantities of culture are required.

1. Take a flask with a long neck, fill it one-third full of broth, plug with wool and autoclave (fig. 83).

2. When cool take out the wool plug and sow the broth with a long Pasteur pipette, taking every care to avoid introducing contaminations. Replace the plug and push it half-way down the neck.

3. Make a shallow constriction below the plug at A, and draw out the upper end B.

4. Connect the upper end B with the water pump: exhaust, and wash with hydrogen: seal the neck above the plug in the flame *in vacuo*, and incubate.

5. To withdraw the culture after incubation, cut the neck above the level of the plug (p. 47), take the plug out, and aspirate the fluid into a pipette or into a sterile distributing flask. [The culture may equally well be drawn up into a Cobbett's bulb by the method used in the preparation of serum (p. 45).]

F. Bottle method. Method recommended.—The advantages of the method are that (1) large quantities of broth can be used, and (2) the culture can be very easily removed.

1. Select a bottle of 1 or 2 litres' capacity with a mouth large enough to take an india-rubber bung perforated with two medium-sized holes. Fill the bottle two-thirds full of broth (fig. 84).

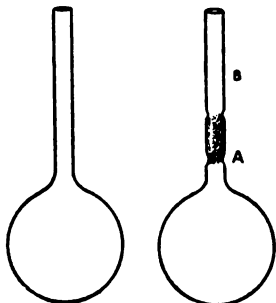

FIG. 83.—Flasks with long necks for the cultivation of anaerobic organisms.

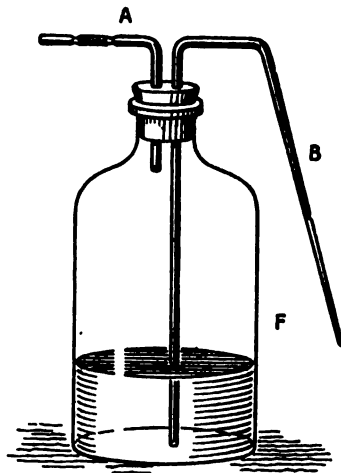

FIG. 84.—Bottle arranged for anaerobic cultivation.

2. Take a piece of glass tubing of the same diameter as the holes in the india-rubber bung, and bend it at right angles about its centre. In one limb make two constrictions a short distance apart, and plug this space with wool. Pass the other limb through one of the holes in the bung so that its lower end projects a distance of 3 or 4 cm. below the bung.

Take another piece of glass tubing and bend it as shown in the figure. Pass the straight limb through the other hole so that it almost reaches the bottom of the bottle, while the other limb terminates outside the bottle in a solid point sealed in a flame.

3. Fit the india-rubber bung firmly into the neck of the bottle and sterilize at 115° C. for 20 minutes, but let the temperature rise gradually for fear of cracking the bottle.

4. When the apparatus has cooled, ascertain that the bung fits firmly, and then lute the joints between the bung and the neck of the bottle and between the tubes and the bung with Golaz's [or paraffin] wax. Dry the wool plug in A by gently heating the glass tube in a Bunsen burner.

5. In order to sow the broth, flame the external limb of B, and break off the point with sterile forceps. Dip the end into the tube containing the organism to be cultivated, aspirate a few drops into the bottle through A, and seal the point of B in the flame.

6. Connect A to the water pump. Exhaust and wash with hydrogen several times, keeping the lower two-thirds of the bottle in a bath of water at 35°-40° C.

7. Seal A in the flame *in vacuo* at the constriction beyond the wool plug. Incubate.

After incubating for 2 or 3 days the gas produced as the result of the growth of the organism accumulates to such an extent as to prevent further multiplication. At this stage it is well to break off the sealed end of A (leaving the cotton-wool plug in position, of course) to allow the pent-up gases to escape; the pressure of the gases remaining in the bottle and continuously generated by the growth of the organism is sufficient to prevent the entrance of air.

It is as well to add a little calcium carbonate or tricalcium phosphate to the medium before sterilizing it, because with some organisms the amount of acid produced is so considerable as very soon to interfere with and perhaps altogether check the growth. If these salts be added, the acids will be neutralized as they are formed.

8. To withdraw the culture from the bottle, flame the end of B and break off the point. Blow through A and collect the culture in a sterile flask.

G. Pyrogallol method. Buchner's tube.—1. Boil a tube of sterile broth, cool rapidly, and sow.

2. Place this tube as already described at p. 89 inside a larger tube containing a solution of potassium pyrogallate, and incubate (fig. 85).



FIG. 85.—Buchner's tube for growing anaerobic organisms.

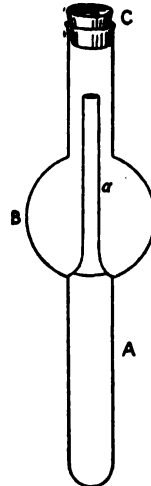

FIG. 86.—Turró's tube.

Turró's tube.—This method has advantages over Buchner's in that the oxygen is much more rapidly absorbed and the culture is visible during incubation (fig. 86).

1. Pour the medium (broth, agar or gelatin) into A through the narrow tube *a*. Plug the upper end of the apparatus with an india-rubber stopper C and autoclave.

2. When it has cooled, sow the medium through *a*; then with a pipette fill the bulb B one-third full of potassium pyrogallate.

3. Replace the stopper C and lute it with paraffin or Golaz's wax. Tilt and rotate the apparatus so that the pyrogallate runs all over the surface of the bulb to accelerate the absorption of oxygen. Incubate.

[H. Bulloch's method. Method recommended.—Bulloch's method is a modification of the preceding, designed to allow of the incubation of a number

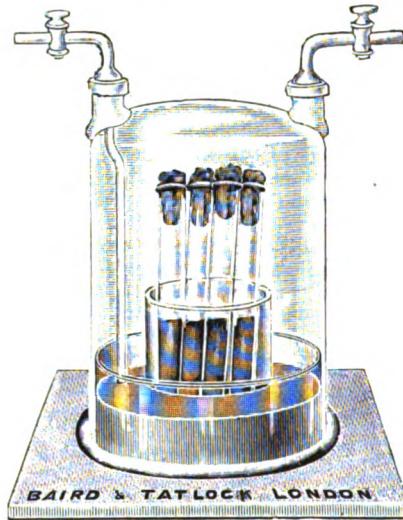

FIG. 87.—Bulloch's anaerobic apparatus.

of plates or tubes at one time. The principle is the same and depends upon the absorption of oxygen by pyrogallate of potassium. The apparatus consists of a circular glass bell jar (fig. 87) flanged below, with two openings above, each of which is fitted with a ground-glass stopper prolonged into a

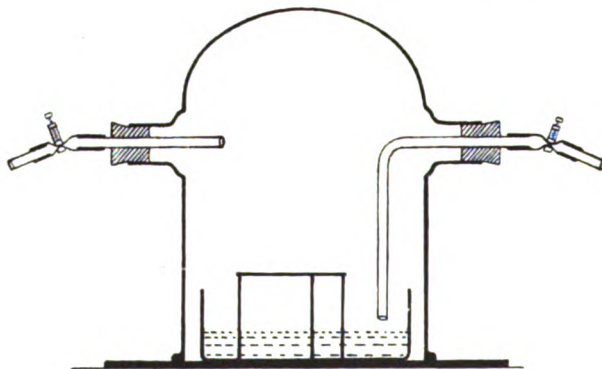

FIG. 88.—A modified form of Bulloch's apparatus.

glass tube bent at right angles and fitted with a closely fitting tap. One of these tubes only passes a few centimetres into the bell jar while the other reaches nearly to the bottom.

[Fig. 88 shows a slightly modified and less fragile form of Bulloch's

apparatus. The openings are laterally situated and are plugged with india-rubber corks, each of which is perforated by a piece of glass tubing. To each of the latter a piece of red rubber pressure-tubing is attached at its outer end. When the apparatus is to be closed, the tubing is compressed by screw clips and a piece of glass rod tightly fitted into its distal end.

[1. On the ground-glass plate stand a shallow glass vessel 3-4 inches deep, but having as large a diameter as will permit of the bell jar being placed over it.

[2. Place about $\frac{1}{4}$ oz. of pyrogallol in the bottom of the vessel.

[3. Place the tubes in a suitable receptacle, and stand the latter on a glass tripod in the vessel containing the pyrogallol.

[4. Grease the lower flanged end of the bell jar with *unguentum resinae*, and press it firmly down on to the ground-glass plate in such a way that the long tube passes into the shallow glass vessel.

[5. Aspirate about 40 c.c. of strong potash solution (30-40 per cent.) into the vessel. Then screw up the clips as tightly as possible, and plug the distal end of the tubing with glass rod.

[6. Incubate.

[7. To remove the tubes, withdraw the pieces of glass rod, gently unscrew the clips, slide the bell jar off the glass plate and lift out the receptacle containing the tubes.]

[I. *Bulloch's method modified.*—**Method recommended.**—The use of pyrogallol and potash is as a rule supplemented by exhaustion and washing with hydrogen.

[1. Proceed as in 1, 2, 3 and 4 above.

[2. Attach the glass tube which passes just inside the apparatus to a water pump connected with a manometer, and the other tube which dips into the vessel to a cylinder of hydrogen.

[3. Exhaust the vessel.

[4. Turn on the hydrogen tap and pass a slow stream of gas until the manometer falls to zero. Unless this be carefully done the pressure of hydrogen will lift the bell jar.

[5. Turn off the hydrogen. Exhaust again.

[6. Wash with hydrogen again, and again exhaust.

[7. Screw up both clips as tightly as possible.

[8. Disconnect the bell jar from the water pump and also from the cylinder of hydrogen.

[9. Connect the tubing that dips into the vessel to a beaker containing a 40 per cent. solution of potash in water. Gently loosen the clip and allow 40 c.c. or so of the solution to enter the bell jar, being careful to allow no air to enter. Screw up the clip.

[10. Insert a tightly-fitting piece of glass rod into each piece of india-rubber tubing on the distal side of the clip.

[11. The vessel is now ready to be placed in the incubator.]

[The security of the joints should be tested on the following day, or even later on the same day. To do this, attach the same piece of tubing as before to the manometer, turn on the water pump to exhaust the rubber connexions, etc., and then loosen the screw clip. If the apparatus is securely fastened the mercury should remain at the same level as when the bell jar was exhausted.]

J. *Legros' method.* **Method recommended.**—By this method the air is excluded from the medium by means of a layer of vaseline oil. Pour sufficient oil into the culture-tube to form a layer 5-10 mm. deep on the surface of the medium. Plug with wool, and autoclave. Sow in the ordinary way through the layer of oil.

In the case of media which cannot be heated strongly, Ch. Nicolle recommends the following modification of the method: Pour sufficient sterile vaseline oil into the flask or tube containing the medium to form a thin layer on the surface. Stand the culture vessel in a water bath at 40° C. and connect the mouth of the vessel to a water pump. After exhausting the whole of the dissolved air the culture medium is protected from air by the layer of oil.

K. Rosenthal's method. Method recommended.—1. Distribute the medium (broth, milk, etc.) into tubes. Pour lanolin previously liquefied by heat into each tube so that it forms a layer 15 mm. thick on the surface. Plug the tubes with wool and autoclave at 120° C. After sterilization, cool the tubes rapidly in a vertical position.

Tubes prepared by this method can be kept for about two months. If kept longer than this, it is well to heat them to 100° C. for 15 minutes before sowing them. It is an advantage to use tubes slightly constricted about the middle; the medium occupies the lower part of the tube up to the constriction, while the lanolin fills the constricted part. Any gas which may be formed easily escapes by pushing the plug of lanolin into the upper non-constricted portion of the tube.

2. When required for use, melt the layer of lanolin in the flame (it liquefies at 42° C.), and sow the organism in the ordinary way through the melted lanolin. Cool rapidly to solidify the fat. Growth takes place in what is practically a sealed tube (Rosenthal).

L. Tarozzi's method.—To grow the strictly anaerobic organisms (*Bacillus tetani*, *Bacillus maligni œdematis*, etc.) by this method it is only necessary to add to broth contained in ordinary tubes a fragment of tissue freshly removed from a rabbit, mouse or guinea-pig, and to proceed as in the case of aerobic organisms.

Pieces of liver, spleen, kidney or lymphatic glands may be used with success, but blood, milk, or the connective tissues are useless for the purpose. To tubes of broth add a small piece of one of the above-mentioned internal organs which has recently been excised with the usual aseptic precautions. Incubate the tubes for a day or two at 37° C., and they are then ready for use. They may be heated to 100°–107° C. for a minute or two, but if the heating be prolonged for more than 5 minutes growth will fail. Cultures will grow even if the piece of tissue be removed before sowing.

A number of other substances have a similar action in facilitating the growth of anaerobic organisms. Wrzosek, Ori, for example, were able to obtain cultures under ordinary conditions in broth by simply adding pieces of vegetable tissue (potato, elder pith, mushrooms, etc.) to the medium. Tarozzi used a slightly alkaline glucose-broth, which had been heated under a pressure of two atmospheres in the autoclave, with successful results. Aperlo was able to grow strictly anaerobic organisms in a simple peptone-broth by sterilizing the medium for half an hour under a pressure of half an atmosphere, and using it within 24 hours of its preparation.

Kata also succeeded with ordinary broth containing a small piece of agar and 0.3–0.7 per cent. of sodium sulphite, and even better with the same amount of sulphite and a little fresh serum. The latter medium would appear to be very useful for toxin production.

Pfuhl recommends a broth made with liver instead of ordinary meat, and sterilized in the autoclave. Satisfactory results were also obtained with the following technique: To a tube containing 10 c.c. of ordinary broth add 1 gram of spongy platinum, boil for 10 minutes, sow as soon as cool and put in the incubator without shaking the tube.

The vitality of anaerobic organisms is exhausted much more quickly on media prepared on these principles than on media under anaerobic conditions (Jungano and Distaso).

2. Solid media.

(i) Stab cultures.

A. In test-tubes. Method recommended. (a) Gelatin.—1. Heat a tube of sterile gelatin to boiling, taking care not to let the medium froth and boil over. Boil for several minutes. [This is best done in a water bath.]

A few drops of sodium sulphindigotate solution may be added to the gelatin before boiling it and if this be done the medium will be decolourized by the growth of the organism.

2. Cool the gelatin rapidly, and when it is set sow a stab culture with a fine platinum wire.

A little air would ordinarily be introduced with the needle, and the following arrangement is devised to obviate this. Mount the wire on the wall of a piece of glass tubing, and connect the other end of the latter to a hydrogen-generating apparatus by means of a piece of india-rubber tubing (fig. 89). To use the needle, after flaming it, take up the material to be sown, then turn on the hydrogen and sow in a current of the gas. In this way the oxygen of the atmosphere is prevented from reaching the needle track.

3. After sowing, dip the gelatin tube into very cold water and pour a layer of agar over the surface with a Pasteur pipette. Replace the plug. The object of this procedure is to form a plug impervious to air on top of the gelatin. Sterilized oil or liquid vaseline, etc., may be used instead of agar.

Note.—The agar plug may be omitted if some very oxidizable substance capable of absorbing oxygen be added to the culture medium (Liberius, Kitasato). The best substances for the purpose are glucose (2 per cent.), sulphindigotate of sodium (0.1 per cent.), sodium formate (0.5 per cent.).

Liberius recommends the following medium :

| | |
|-----------------------------------|-------------|
| Ordinary agar, - - - - - | 1000 grams. |
| Glucose, - - - - - | 20 " |
| Sodium sulphindigotate, - - - - - | 1 gram. |

Nearly fill the tubes with the medium, and sow deep stab cultures as described above.

(b) Agar.—The method is the same as in the case of gelatin.

B. Absorption of oxygen by an aërobic organism (Roux).—Proceed as above, and when the agar plug has set sow the surface with *B. subtilis*. This organism is strictly aërobic and absorbs the oxygen present in the tube, while growth below takes place under anaërobic conditions in an atmosphere free from oxygen.

To reach the anaërobic organism without contaminating it with the *B. subtilis*, wash the outside of the tube with perchloride of mercury, cut it across about the level of the middle of the growth, break off the lower part of the tube, and the anaërobic organism can then be removed without contaminating it.

C. Roux's pipette.—1. Flame and break off the point of a Roux's pipette. Dip the end into a tube of sterile gelatin which has just been boiled. Draw the gelatin into the tube until it reaches the constriction *a*, fig. 67, p. 75. Seal the narrow end of the pipette and the upper end at the constriction. Dip the whole tube into cold water to cool it quickly.

2. When the gelatin has set, pass the upper part rapidly through the flame, and then break off the point *a* with a pair of forceps. Through the opening sow a stab culture with a fine wire. Seal the opening in a flame.



FIG. 89.—
Wire for sowing anaërobic stab cultures.

3. To open the tube when growth has taken place, break off the lower end over a sterile glass plate. If the upper end were opened first the pressure of the gases formed during the growth of the organism would be sufficient to forcibly expel the contents of the tube.

D. Hydrogen method (Roux).—This method is more difficult than those just described.



FIG. 90.—Roux's method of growing anaerobic organisms.

1. Take a tube of sterile gelatin, and constrict in the blow-pipe just below the plug (*a*, fig. 90).

2. Select a sterile Pasteur pipette the smaller end of which will easily pass through the constriction, and bend it at a right angle below the wool plug. Connect the plugged end of the pipette with a hydrogen apparatus.

3. Melt the gelatin in a water bath. Flame the narrow part of the pipette to sterilize it, and after breaking off the point pass it between the wool and the side of the tube down to the bottom of the gelatin.

4. Pass a stream of hydrogen through the medium for some minutes, and then withdraw the pipette a little so that the hydrogen passes over the surface of the gelatin and prevents air gaining access to the medium while it is being cooled.

5. Take out the wool plug and sow a stab culture with a fine wire, the current of hydrogen being maintained meanwhile.

6. When the tube is sown, take out the pipette and seal the tube as quickly as possible at the constricted part *a*.

[**E. Bulloch's apparatus** can be used equally well with solid as with liquid media (p. 96).]

(ii) Surface cultures.

Gelatin and agar.

[**Bulloch's apparatus** is available for the growth of anaerobic organisms in surface culture (pp. 96 and 102).]

Roux's tube.—Roux's tube for stroke cultures of anaerobic organisms consists of an ordinary test-tube *T* drawn out above (*A*) and provided with a lateral branch *B* (fig. 91).

1. Pour some gelatin into the lower, wider part of the tube *T*, using a narrow-stemmed funnel for the purpose. Seal the tube at the constriction *a* in its upper part. Plug the side tube *B* with wool between the two constrictions *b* and *b'*. Sterilize in the autoclave.

2. Attach *B* to the water pump, stand the tube in a water bath at a temperature just sufficient to keep the gelatin melted while the tube is exhausted and washed two or three times with hydrogen.

3. When the air has been displaced by hydrogen, leave the tube in a slanting position while the gelatin sets.

4. Then flame the upper part of *A*, break off the point *a*, and sow a stroke culture through the opening; the tube *B* must at the same time be connected with the hydrogen-generating apparatus and a stream of hydrogen passed into the tube to prevent the access of air. Seal the top of the tube *A* again.

5. It now only remains to seal *B* at the constriction *b'*. Growth then takes place in an atmosphere of hydrogen. If necessary the tube can be again exhausted after sowing and sealing *a*, before sealing *b'*.

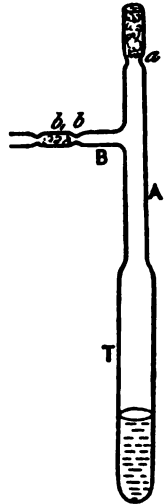

FIG. 91.—Roux's tube for stroke cultures of anaerobic organisms.

Potato.

Roux's tube.—1. Blow on to an ordinary potato-tube below the constriction, a lateral tube B, and plug the latter with wool between two constrictions (fig. 92). (These tubes can be bought ready made.) Place a piece of potato in the tube, and sterilize it in the autoclave at 120° C.

2. Sow the potato in the ordinary way, and then seal the upper end of the tube below the wool plug in the flame (fig. 92).

3. Attach B to the pump. Exhaust and wash with hydrogen.

4. Seal the side tube B at the constriction *b'* under a vacuum, and incubate.

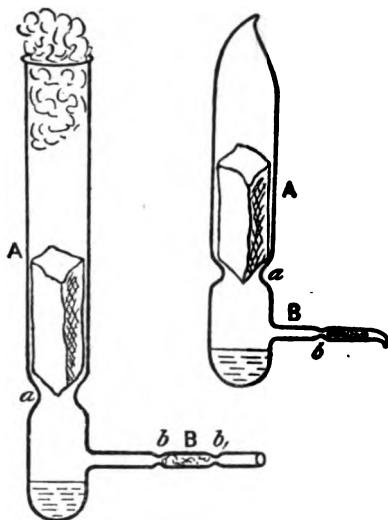

FIG. 92.—Roux's tubes for sowing cultures of anaerobic organisms on potato.

SECTION III.—THE ISOLATION OF ANAEROBIC ORGANISMS.

1. Plate method.

A. On sheets of glass.—The method is similar to that described for aerobic organisms. The technique is difficult but has the advantage that the colonies can be examined under the microscope.

1.—(1) Sow three tubes of liquefied sterile gelatin with the organism under investigation, and pour three plates as in isolating aerobes (p. 78).

(2) Have a vacuum desiccator (previously washed inside with perchloride) at hand, and pour some potassium pyrogallate (p. 89) into the sulphuric acid vessel. A vacuum incubator (p. 104) can also be used.

(3) Arrange the plates on the shelves as they are poured.

(4) Lute the bell jar, exhaust, and wash with hydrogen. Disconnect the bell jar by closing the tap connecting it to the pump.

2. Turro has simplified the method by arranging the plates on glass benches in a large glass dish into the bottom of which some potassium pyrogallate is poured. The ground glass cover of the glass dish is then sealed with paraffin. Agar can be used for the plates, and the whole incubated.

B. Kitasato's dish.—A circular flat glass dish of the size of a Petri dish is fitted with two tubes A and B on opposite sides. The tube B is drawn out and sealed. A is plugged with wool (fig. 93).

This is a satisfactory though fragile and rather expensive piece of apparatus.

1. Sterilize the apparatus in the hot air sterilizer.

2. After flaming the end of B, break off the point and dip the end into a gelatin tube already sown, and aspirate the medium into the dish through A. Seal B, and let the gelatin solidify.

3. Attach A to the pump. Exhaust, and wash with hydrogen. Seal A at the constriction *a*.

C. Bombicci's apparatus.—This vessel is cheaper than Kitasato's. It consists of a circular flat glass dish with a cylindrical appendix of about 10 c.c. capacity.

1. Pour the medium, agar or gelatin, into the appendix, plug the neck with wool and sterilize in the autoclave.

2. Select an india-rubber plug with two holes which fits the neck of the dish. Fit it with two tubes as shown in the figure and plug the horizontal limb of each with wool



FIG. 93.—Kitasato's dish.

between two constrictions. Wrap the plug with the tubes in position in paper, and sterilize separately from but at the same time as the dish.

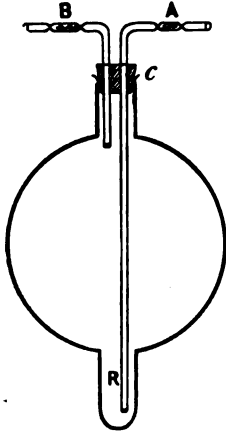

FIG. 94.—Bombicci's dish.

3. Keep the gelatin or agar liquefied in a water bath at 30°–40° C. as the case may be, while sowing the medium. Take the india-rubber plug out of its wrapper and fit it into the neck of the dish as quickly as possible.

4. Lute the plug with Golaz's wax, attach A to the hydrogen-generating apparatus, keeping the medium liquefied in the water bath, and pass a stream of hydrogen through the medium for a few minutes. Lay the apparatus horizontally so that the medium flows into the dish and continue the current of hydrogen for several minutes. Exhaustion may be combined with washing with hydrogen if it be thought necessary.

5. Seal the ends of A and B beyond the wool plugs.

D. Zinsser's method.—Zinsser uses an apparatus similar to a Petri dish, but deeper, and having an annular space of 5–6 mm. between the dish and the cover. The agar or gelatin, as the case may be, is sown and poured into the dish, and after it is set is inverted on to the cover, into which a little alkaline pyrogallol is poured (p. 89). A layer of oil is poured on the surface of the pyrogallate in the annular space.

E. Tarozzi's method.—Tarozzi uses an alkaline glucose agar which has been heated under a pressure of two atmospheres (p. 98). The medium is poured to a depth of 1 cm. into Petri dishes with ground-glass covers, which are luted with paraffin.

F. Marino's method.—1. Take a number of Petri dishes, remove the lids, and place the dishes, cavity upwards, over (and therefore partly within) them. Wrap in paper and sterilize in the hot air sterilizer.

2. Take a number of large test-tubes, and into each pour 30 c.c. of 0.5 per cent. glucose-agar. Sterilize in the autoclave.

3. Cool the agar to 40°–42° C. in a water bath. Add to the contents of each tube 1 c.c. of rabbit- or horse-serum previously heated at 55° C. for 20 minutes.

4. Sow the tubes by the dilution method.

5. Pour the contents of each tube into the lid of one of the sterile Petri dishes, and cover with the other part of the dish in such a way that the agar is contained between and compressed by two sterile glass surfaces, the cavity of the dish being obviously upwards. Cover with a sterile glass plate large enough to project beyond the edges of the Petri dish to protect it from contamination. Incubate.

6. After the colonies have grown, gently separate the agar from one of the glass surfaces, leaving it adhering to the other, and pick off with a fine-pointed pipette, any colonies it is thought desirable to examine.

When separating the medium from one of the glass surfaces it often happens that the agar is torn; so it may be that the colony which was wanted cannot be found, or else that it has become contaminated, by rubbing up against another colony or by contact with the water of condensation.

Liefman, Fehrs and Sachs-Müke's modification of Marino's method obviates this defect. Instead of the lower part of the Petri dish a plate of sterile glass is used as a cover, and sufficient medium is poured into the lid to slightly overflow the edges. In covering with the sheet of glass care must be taken that no air bubbles are included.

[G. Bulloch's apparatus. The technique as now generally adopted has been explained at p. 96. The only modification required in the present

connexion is the use of Petri dishes containing a solid medium instead of tubes of a liquid medium. It will be necessary, of course, to have a glass tripod or a thick sheet of cork on which to stand the dishes, in order to prevent the lower ones being flooded with the pyrogallate solution. It is advisable also to stand some water in a Petri dish on the top of the uppermost plate.]

2. Tube method.

A. Esmarch's tubes.—Fränkel, Roux have adapted the Esmarch tube method of isolating aerobic organisms to the isolation of anaerobic species. The technique recommended by these authors is somewhat complicated, and is now very rarely used.

Fränkel's method.—Fränkel prepares an Esmarch tube (p. 81), and after sowing the medium in air, displaces the latter by hydrogen by means of an arrangement similar to that described in Bombicci's method (p. 101). After passing the hydrogen through the medium for 5 or 10 minutes the tube is rolled as in the ordinary Esmarch method.

Roux's method.—Roux sterilizes the medium in a test-tube the upper part of which has been narrowed by drawing it out in the flame (fig. 95, left-hand figure). When cool but still liquid the medium is sown. The narrowed part of the tube is then constricted at two points and the wool plug pushed down between them (fig. 95, right-hand figure.) Attach the tube to a water pump, exhaust and wash with hydrogen, seal at the upper constriction, and roll the gelatin. To remove the colonies, cut off the upper part of the tube and pass a platinum wire through the opening.

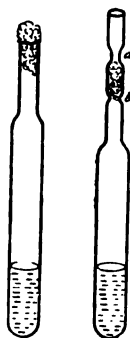

FIG. 95.—Esmarch's tubes applied to anaerobic cultivation.

B. Vignal's tube. Method recommended.—1. Take a piece of glass tubing about 1 metre long and 3 or 4 mm. in diameter. Draw out one end in the flame and plug the other with wool. Make a constriction in the tube 3 or 4 cm. below the wool plug (fig. 96). Heat the tube thoroughly in the flame to sterilize it.



FIG. 96.—Vignal's tube.

2. Heat a tube of sterile gelatin to boiling point (the medium may, if desired, be coloured with sulphindigotate of sodium). Let the gelatin cool in a current of hydrogen (p. 100), but sow it before it sets, also in a current of hydrogen. Rotate the tube between the hands to distribute the organisms through the medium.

3. Flame the sealed end of the tube, and break off the point. Dip the end into the gelatin, and aspirate the medium into the tube up to the constriction A. (It is necessary to take care that no bubbles of gas enter the tube.) Seal the pointed end and then close the tube at A (fig. 96, A').

Colonies soon appear scattered through the gelatin. The growth can be removed by carefully flaming the tube or washing it, first in perchloride then in alcohol, in the neighbourhood of the colony which it is desired to examine. Cut the tube at the sterilized part and remove the growth with a needle.

C. Method of Liborius-Veillon. Method recommended.—Liborius' agar (p. 99) which is used for deep stab culture is also available for the isolation of anaerobic micro-organisms. The tubes are sown by the dilution method (p. 79) and cooled rapidly. For the examination and sub-cultivation of the colonies, Liborius recommended turning out the agar on to the inside of the lid of a sterile Petri dish and cutting out the colonies with a sterile knife, a process which was not only rather difficult but exposed the colonies to

contamination. To overcome these disadvantages, the method has been modified by Veillon and as modified by him is now [one of] the best methods of isolating anaërobic organisms.

1. Fill a number of large test-tubes (22 cm. \times 15 mm.) to a depth of 10 to 15 cm. with some quite transparent agar containing 1.5 per cent. of glucose. Sterilize in the ordinary way but do not allow the temperature to exceed 120° C.

2. When ready to sow the tubes, heat five to ten of them to 100° C. in a water bath, and boil them for 20 minutes or so to liquefy the agar and drive off the air dissolved in the medium. Then transfer the tubes to a water bath at 40° C. to keep the agar liquid until sown.

3. Add one drop of the material to be sown to the first tube, and disseminate it by rolling the tube between the hands.

4. Sow the second tube with a few drops from the first, the third from the second and so on, as previously described.

5. Immediately the tubes are sown, cool them rapidly in the upright position. Incubate.

Aërobic organisms grow in the upper part of the medium which contains a certain amount of air in solution, while the anaërobes multiply in the deeper layer.

6. When carefully examined it will be found that growth soon makes its appearance, the number of colonies depending upon the extent to which the material with which they were sown was diluted. Examine the different colonies with the naked eye and with a lens and select the tubes containing the smallest number of colonies for the purposes of sub-cultivation.

To sub-cultivate, take a Pasteur pipette with a fine point, break off the end, and holding the culture-tube horizontally remove the wool plug and pass the fine end of the pipette into the agar towards the colony to be removed: as the pipette is passed through the colony some of the growth is forced into it; withdraw the pipette and sow the colony in a fresh tube of medium.

It facilitates the process of sub-cultivation to put, as Guillemot advises, an india-rubber teat on the plugged end of the pipette; the colony can then be more easily drawn into the pipette by aspiration, and forced out into the new medium by compression of the teat.

Great care must be taken that the pipette does not touch any colony other than that to be sub-cultivated; the only way of avoiding such an accident is to work with cultures in which the colonies are few in number and sufficiently well isolated one from another.

Note.—It is often an advantage to use a medium containing serum, since many anaërobic bacteria grow better in albuminous media. Prepare the agar as above, melt the contents of the tubes, and cool to 40° C. in a water bath, then to each tube for two parts of agar add one part of sterile liquid serum also heated to 40° C.: mix the agar and serum thoroughly, keeping the medium at 40° C. to prevent the contents solidifying, and sow with the material.

SECTION IV.—VACUUM INCUBATORS.

Anaërobic organisms can be cultivated in ordinary culture vessels, provided that these are incubated in a special form of incubator which can be exhausted and the vacuum maintained. A little water, or, better, solution of potassium pyrogallate which absorbs oxygen, should always be placed in these incubators to prevent desiccation of the medium.

In discussing isolation of anaërobic organisms by the plate method, Roux's

vacuum bell jar has already been described. Tretróp's (fig. 97), or Baginski's apparatus, or Adnet's vacuum incubator are also available. The last is a

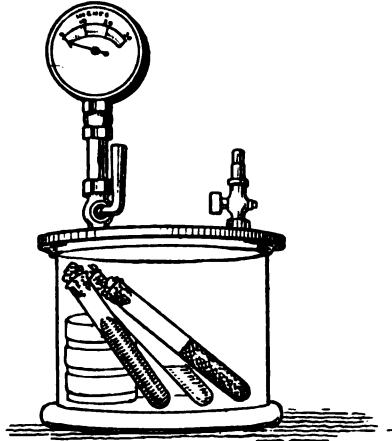

FIG. 97.—Tretróp's apparatus, in which to grow anaërobic cultures.

stout-walled incubator which can be hermetically closed by means of a door with an india-rubber washer and is provided with a Roux's regulator and a gas burner.

CHAPTER VII.

THE MICROSCOPE.

Introduction.

Section I.—The microscope stand, p. 106.

Section II.—The optical parts of the microscope, p. 107.

A. The objectives, p. 107. B. The eyepieces, p. 116.

Section III.—The care of the microscope, p. 117.

Section IV.—The method of using the microscope, p. 118.

Section V.—The measurement of microscopical objects, p. 121.

1. The experimental determination of the magnification produced by a system of lenses, p. 121. 2. The measurements of objects under the microscope, p. 122.

Section VI.—Dark-ground illumination, p. 123.

1. The application of dark-ground illumination to micro-biology, p. 124. 2. The construction of the dark-ground illuminator, p. 124. 3. The method of using the instrument, p. 125.

FOR bacteriological work a good microscope, which will magnify from 600 to 1200 diameters, is necessary. It is seldom that a higher magnification than 1200 diameters is required, though for a few micro-organisms, *e.g.* the organism of pleuro-pneumonia, a magnification of 2000 diameters may be useful. It is to be remembered however that with the very best instruments it is impossible to see organisms measuring less than 0.0001 mm. (0.1μ) in diameter (p. 113).

A microscope may for purposes of description be regarded as consisting of two parts, the mechanical (the microscope stand) and the optical (the lenses) portions respectively.

SECTION I.—THE MICROSCOPE STAND.

The stand of the microscope must be firm and rigid, and it is desirable that the base be hinged to the body so that the latter can be tilted. The tube should have a rack and pinion mechanism and a micrometer screw adjustment for the grosser and more delicate movements respectively in focussing. The stage, of ebonite or metal, should be large, and it is an advantage if it can be centred and mechanically moved. The mirror, by means of which the light is transmitted to the object, should be concave on one side and flat on the other. The stand, moreover, should be so constructed that an Abbe condenser can be fitted below the stage. A diaphragm either of the cylindrical or iris pattern is also essential. It will be found a great advantage to have a triple nosepiece capable of carrying three objectives, so that one lens can be readily and quickly substituted for another.

SECTION II.—THE OPTICAL PARTS OF THE MICROSCOPE.

The great difficulty in selecting a microscope is the choice of the lenses. For ordinary work two eyepieces, and four objectives including a $\frac{1}{12}$ -in. oil-immersion lens, are all that is necessary.¹

A $\frac{1}{8}$ -in. or $\frac{1}{16}$ -in. homogeneous immersion lens may be of use occasionally.

In addition to the microscope and its lenses, it is convenient to have a camera lucida and a stage and ocular micrometer.

A. The objectives.²

The use of a microscope is to magnify the details of an object, so that those invisible to the naked eye may with its aid be easily seen. The essential requisites then in good lenses are definition and magnification.

1. Magnification.

The apparent linear size of an object AB (fig. 99) varies inversely as its distance BK from the eye of the observer, and depends upon the tangent of the visual angle α which it subtends at the nodal point K of the eye.

$$\tan \alpha = \tan BKA = \frac{BA}{KB}$$

Now, let B'K denote the least distance of distinct vision (10 inches), and let it be denoted by l .

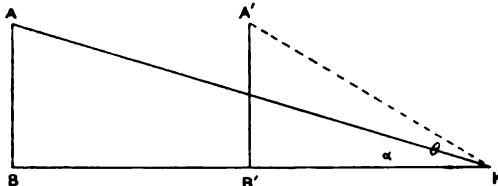

FIG. 99.

Then the greatest apparent size of BA to the unaided eye is when it is in the position B'A', and its apparent size is then

$$\tan \theta = \frac{B'A'}{KB'} = \frac{B'A'}{l}$$

It follows from this that the larger the angle subtended by the object at K, the larger will the object appear to be. And a microscope is nothing more than an instrument with which to increase the size of this angle.

¹ In French makes, and also in Reichert's and Leitz' lenses a No. I. or No. II. and a No. III. eyepiece, and a 2, 6, and 8 or 9 dry objective. In Zeiss' list the corresponding objectives are AA, DD, and E in the dry series, and eyepieces, 2, 4 and 8.

[² The remainder of this section, dealing with the theory of the microscope, has been rewritten and considerably extended.—H. J. H.]



FIG. 98.—A microscope.

If a convex lens of focal length 2 in. be placed 2 in. in front of an object AB (fig. 100), the divergent pencil of light from A, HAO, will emerge from the lens as a parallel beam F''H, LO, as if it came from an object A' at an infinite distance off, while the divergent pencil of rays from B will emerge from the lens as a beam parallel to the axis, as if it came from B' at an infinite distance off. The image is virtual,

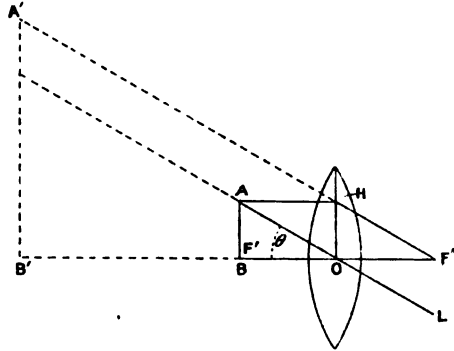

FIG. 100.

not real, and cannot therefore be received on a ground-glass screen, but it appears to the eye as if it came from a big object at an enormous distance away.

The visual angle which this huge image at an infinite distance subtends at the eye will obviously be BOA or θ' , and

$$\tan \theta' = \frac{BA}{OB} = \frac{BA}{-F'O} = \frac{BA}{-f'}$$

But

$$\tan \theta = \frac{BA}{-l}$$

$$\therefore M = \frac{\tan \theta'}{\tan \theta} = \frac{l}{f'} = \frac{10}{2} = 5.$$

The object is therefore magnified 5 times by the convex lens of 2 in. focal length placed 2 in. from it. The positive sign shows that the image is erect and virtual.

Now suppose it be required to magnify an object 10 times (linear) it is clear that a lens of 1 in. focal length would have to be used, for

$$M = \frac{10}{f'} = \frac{10}{1},$$

and to obtain a magnification of 400 it would be necessary to have a lens of focal length $\frac{1}{40}$ in., and the object would therefore have to be not more than $\frac{1}{40}$ in. away from the lens; this in most cases would be impossible, not to speak of the extreme spherical and chromatic aberration that would be induced by using a single lens of that high degree of curvature.

There is a simple method by which some of these defects may be overcome, which may be illustrated by a consideration of the simple magnifying glass of 1 in. focal length mentioned above. In this case the lens must be placed 1 in. away from the object to induce a magnification of ten diameters. Now if this biconvex lens be split down the middle, two plano-convex lenses will be formed each of 2 in. focal length. On placing one of these lenses $2\frac{1}{2}$ in. away from the object AB, an enlarged inverted image *ab* will be formed at a distance of 18 in. from the lens (fig. 101).

$$\text{(For } \frac{1}{p} - \frac{1}{q} = \frac{1}{f'}; \therefore \frac{1}{q} = \frac{1}{p} - \frac{1}{f'} = \frac{4}{9} - \frac{1}{2} = -\frac{1}{18}; \therefore q = -18 \text{ in.,}$$

where *p* is the distance from the object and *q* the distance from the image to the lens, and *f* the focal length of the lens.)

On now placing the second plano-convex lens 2 in. beyond this image (i.e. with the image at its focal distance, it will be magnified again. This is the funda-

mental principle of the compound microscope. The first lens, or objective, forms an inverted image 8 times the size of the object.

(For $\frac{i}{o}$ or $\frac{ba}{BA} = \frac{IH}{F'I} = \frac{F'I}{F'I - BI} = \frac{f'_2}{f'_2 - p} = \frac{2}{2 - 2\frac{1}{4}} = -8$.)

The negative sign shows that the image is inverted.)

The second lens or eyepiece is now placed 2 in. from this image, i.e. 20 in. from

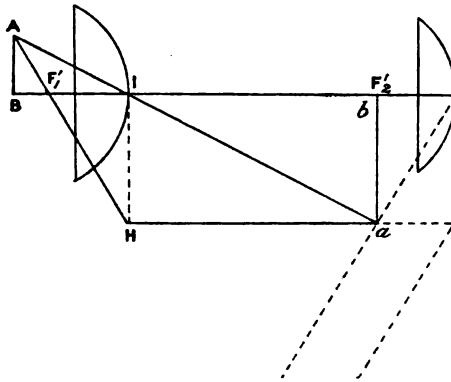

FIG. 101.

the objective, so that the inverted image ba is in its first focal plane. Consequently the image ba will be seen under a magnification of $\frac{l}{f'_2} = \frac{10}{2}$ or 5. The total magnification will be therefore $-8 \times \frac{10}{2} = -40$.

It follows, then, that by this arrangement the working distance is increased from 1 in. to $2\frac{1}{4}$ in., that the magnification is increased from 10 to -40 , while the errors from spherical and chromatic aberration are rather less than with a single biconvex lens of 1 in. focus. Indeed, with the compound instrument, what is called "pincushion distortion" would be almost entirely obviated. If an object were a network of squares, it would be found that, on using a simple magnifying lens, it would present the appearance shown in fig. 102 (pincushion distortion), owing to the fact that the peripheral parts of the object would be more magnified than the central parts. When however a compound instrument is used such as that just described, the objective forms a real image showing "barrel-shaped distortion" as in fig. 103, because the peripheral parts are less magnified than

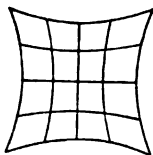

FIG. 102.—
Pincushion distortion.

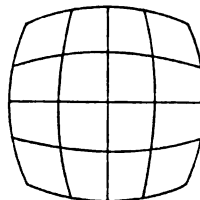

FIG. 103.—
Barrel-shaped distortion.

the central parts. On now viewing this through the second lens, or eyepiece, the barrel-shaped distortion will be completely corrected by the tendency of the virtual image to suffer from pincushion distortion, so that the final image will be rectangular. The fact that it is inverted is no inconvenience.

The enormous advantage of a compound instrument is sufficiently obvious from this simple illustration, but it must be remembered that the eyepiece only magnifies

the detail that has already been defined in the real image formed by the objective, and that any defects in this image are exaggerated by the magnification of the eyepiece.

2. Spherical aberration—Coma.

As it is of supreme importance to obtain the most perfect objective possible, some of the defects in the image formed by a simple convex lens when homogeneous light (light of one specific wave-length, *i.e.* of one colour) is used will be considered first and their correction explained, and then the defects in the image due to chromatic aberration when ordinary white light is used will be very briefly referred to.

The defects in the image formed by a simple convex lens when homogeneous light is the illuminant are two:—*spherical aberration and coma.*

Suppose a small bright point P (fig. 104) to lie on the axis of a biconvex lens; now, although the small axial cone converges fairly accurately to the conjugate focus Q, the eccentric rays PL, PL' converge to a nearer focus Q'. The peripheral parts of a lens refract light more strongly than the central parts, and hence the image of the point P will be blurred on account of **spherical aberration**. The only way of getting over this difficulty known to the early opticians was to cut off the peripheral rays by means of a diaphragm, but this, of course, very seriously diminished the brightness of the image.

Now take the case where a point P' (fig. 105) does not lie on the axis of the lens;

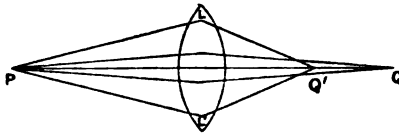

FIG. 104.

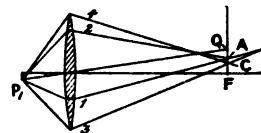
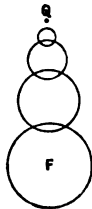

FIG. 105.

the image of P' will be indistinct for a reason which is somewhat similar to that given in the former case, as will be evident from a glance at the figure. The centric pencil will form a well-defined image at Q, but while the rays 1 and 2 will intersect at A the rays 3 and 4 will intersect at C. Hence if a screen be placed in the position QF a bright point will be seen at Q, which becomes an ill-defined flare of light towards F' (fig. 106). The image somewhat resembles the tail of a comet and the defect is therefore known as **coma** (*κόμη*, hair of the head, tail of a comet), and may be regarded as the spherical aberration for object points not on the axis.

FIG. 106.—
Coma.³

These two defects, spherical aberration and coma, must therefore be corrected before any definite distinct image can be formed by an objective. An image free from these defects is known as an **aplanatic image** (*ἀπλανής*, not wandering). The condition for aplanatism can only be obtained in one way—the lenses must satisfy what is known as Abbe's sine law.

The sine condition for aplanatism.—Let C be the centre of the circle KAK' (fig. 107), and let P be a point situated at a distance CP from the centre of the circle, such that

$$\frac{CK}{PC} = \frac{\mu}{\mu'}$$

i.e. the radius of the circle : the distance of the object to its centre

:: the index of refraction of the first medium : the index of the second medium.

¹ F, in this figure, is arbitrary and not the focus.

³ In "primary" coma the angle formed by the tangents to the series of circles from the point Q in this figure is said to be 60°.

Now find the point Q on the axis such that

$$\frac{QC}{CK} = \frac{\mu}{\mu'}$$

By construction

$$\frac{CK}{PC} = \frac{\mu}{\mu'} = \frac{QC}{CK}$$

i.e. the sides of the triangles PCK, CKQ about the common angle C are proportional.

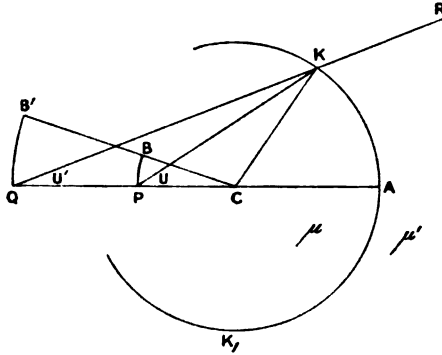

FIG. 107.

∴ by Euclid vi. 6, the triangles are equiangular, viz. $\angle CKQ = \angle KPC$ and $\angle KQC = \angle CKP$.

Now

$$\frac{\sin \angle CKP}{\sin \angle CKQ} = \frac{\sin \angle KPC}{\sin \angle KQC} = \frac{PC}{CK} = \frac{\mu'}{\mu} = h,$$

where h is the relative index of refraction of the second medium to the first medium.

But if P be a source of light,

$$\sin \angle CKP = \sin \phi = h \sin \phi' = h \sin \angle CKQ,$$

where ϕ = angle of incidence, and ϕ' angle of emergence.

∴ KR must be the refracted emergent ray.

Now the position of K is arbitrary; therefore all the light diverging from P, however great the angle U, must after refraction appear to come from Q. (The angle U, or $\angle CPK$, represents of course merely one-half the cone of light that falls on the lens.)

This then satisfies the first condition of aplanatism; in other words, the spherical aberration is corrected.

With an oil-immersion lens, seeing that the oil and the glass have practically the same index of refraction, the object may for all practical purposes be regarded as in the glass, which is exactly the condition required to satisfy the sine condition.

For the second condition,—the correction of coma:

From centre C at distances CP and CQ draw arcs PB and QB' (fig. 107). Join CBB'. Then CBB' may be regarded as the axis of the lens, and the image of B will be formed at B'.

Regard PB as the object o , and QB' as the image i .

$$\begin{aligned} \text{Then } \frac{i}{o} &= \frac{QB'}{PB} = \frac{QC}{PC} = \frac{\mu}{\mu'} \frac{CK}{PC} = \frac{\mu \sin \angle KPC}{\mu' \sin \angle CKP} \\ &= \frac{\mu \sin \angle KPC}{\mu' \sin \angle KQC} = \frac{\mu \sin U}{\mu' \sin U'}; \end{aligned}$$

that is,

$$\frac{\text{dimensions of the image}}{\text{dimensions of the object}} = \frac{\text{index of refraction of first medium} \times \sin \text{ of half the angle of the rays diverging from the object}}{\text{index of refraction of final medium} \times \sin \text{ of half the angle of convergence of the rays forming the image}}$$

and this is the one and necessary test for aplanatism.

3. Angular aperture.

The angle U (fig. 107) is the semi-aperture of the lens; and the total aperture ($2U$) is the angle formed by the two extreme rays, which starting from the same point on the object ultimately reach the eye of the observer. And obviously, the greater the angle of aperture the greater will be the number of rays of light which leaving the same point on the object reach the eye of the observer, and consequently the brighter will be the image of a given size. So that it is important, especially with the more highly magnifying lenses, that the angle of aperture should be as large as possible. Lenses are now made whose angular aperture is 140° or even more. The angle of aperture is measured with the aid of a special piece of apparatus known as an *apertometer*.

4. Numerical aperture.

The expression $\mu \sin U$ is commonly known as the numerical aperture of the lens, and is denoted by N.A.

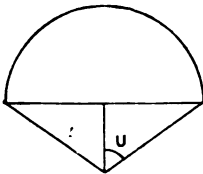

FIG. 108.—Numerical aperture.

It will be easily seen that the brightness of the image varies amongst other things as $(N.A.)^2$. For the numerical aperture determines the amount of light entering in one diametral plane of the objective, and therefore the total amount of light entering the circular objective must vary as $(N.A.)^2$.

Lenses are more commonly described by their numerical aperture than by their angular aperture. The N.A. of a $\frac{1}{8}$ -in. dry lens should not be less than $\cdot 82$, and of a $\frac{1}{2}$ -in. oil-immersion lens not less than $1\cdot 3$.

The N.A. is determined thus: Suppose a dry objective has an angular aperture of 60° .

Let $U = \frac{1}{2}$ angular aperture, and since the refractive index of air is 1,

$$\begin{aligned} N.A. &= \mu \sin U \\ &= 1 \sin 30^\circ \\ &= \cdot 5. \end{aligned}$$

Again, suppose an oil-immersion objective has a total angular aperture of 135° .

$$U = \frac{1}{2}(135^\circ) = 67\frac{1}{2}^\circ \quad \text{and} \quad \sin 67\frac{1}{2}^\circ = \cdot 9238795.$$

then

$$\begin{aligned} \mu \text{ for cedar-wood oil} &= 1\cdot 52; \\ N.A. &= \mu \sin U, \\ &\approx 1\cdot 52 \times \cdot 924, \\ &\approx 1\cdot 404; \end{aligned}$$

and if the same lens be used dry, since the critical angle for glass is 41° , the total effective angular aperture would be 82° .

$$\begin{aligned} \mu \text{ for air} &= 1, \quad \text{and} \quad \sin 41^\circ = \cdot 656059; \\ \therefore N.A. &\approx \cdot 656. \end{aligned}$$

5. Resolving power.

The resolving power of a lens is the capacity of the lens to optically separate two closely adjacent points on an image which the unaided eye is unable to distinguish as separate, and must be carefully distinguished from magnifying power.

It is found¹ that two objects at a distance d apart can be separated by oblique illumination if

$$d = \frac{\cdot 61\lambda}{2\mu \sin U} = \frac{\cdot 61\lambda}{2N.A.};$$

¹ *The Theory of Optical Instruments*, by E. T. Whittaker, M.A., F.R.S.; Camb. Univ. Press; 2s. 6d.

and by direct illumination if

$$d = \frac{.61\lambda}{\text{N.A.}}$$

where λ = wave length of light used.

Thus, in the middle of the spectrum,

$$\lambda = .00054 \text{ mm.},$$

and N.A. in the very best lenses = 1.6 ;

$$\therefore d = \frac{.61 \times .00054}{2 \times 1.6} \approx .000103 \text{ mm.},$$

from which it is apparent that it is impossible to distinguish, i.e. to resolve, any two points less than .000103 mm. (approximately 0.1μ) apart, or to see the details of an object of smaller dimensions than 0.1μ .

Limit of effective magnification.—Now the eye can only easily distinguish two objects as separate whose distance apart subtends an angle of $2'$ at its nodal point. This is the angle which a distance of .1477 mm. subtends at 10 inches. Then the necessary magnification is $\frac{.1477}{.0001} \approx 1477$. Consequently, the limit of resolution of the microscope is attained when the total magnification is about 1450. With an high eyepiece a further magnification may be obtained up to 1600 or 2000, or even 3000, but no more detail will be discoverable. The effect of the higher magnification will merely make the detail larger: it will add no new detail but will still further diminish the brightness of the image.

Resolving power $\propto \frac{1}{d}$, for it varies inversely as the least distance between separable points. Hence, *whatever the focus*, the resolving power $\propto \text{N.A.}$, and *comparing lenses of the same focus*, the brightness of the image $\propto \frac{(\text{N.A.})^2}{M^2}$.

6. Brightness of image.

Suppose M and M' be the magnifications obtained, using the same objective but different eyepieces, and let

$$M' = 2500, \text{ and } M = 1450.$$

The relative brightness $\frac{B'}{B}$ of the image in the two cases will be

$$\frac{B'}{B} \propto \frac{(\text{N.A.})^2}{M'^2} \div \frac{(\text{N.A.})^2}{M^2} \propto \frac{(1450)^2}{(2500)^2} \quad \propto \frac{1}{3};$$

so that the penalty of increasing the magnification from 1450 to 2500 is to make the brightness of the image $\frac{1}{3}$ what it was with the lower magnification.

The penetrating power $\propto \frac{1}{\text{N.A.}}$, so that

| | Resolving power $\propto \text{N.A.}$ | Brightness of image $\propto (\text{N.A.})^2$ | Penetrating power $\propto \frac{1}{\text{N.A.}}$ |
|-------|--|--|--|
| Ratio | { Oil | 1.404 | 1.972 |
| | { Dry | .656 | .43041 |
| or | { Oil | 2.14 | 4.58 |
| | { Dry | 1 | 1 |
| | | | 1 |
| | | | 2.14 |

H

That is to say the resolving power—the capacity to recognize as distinct two closely adjacent points—is more than twice as great, and the brightness of the image more than $4\frac{1}{2}$ times as great when the same lens is used with oil as when used dry; while as regards penetrating power a dry lens is more than twice as efficient as an oil lens, so that when thick sections have to be examined a dry objective of low N.A. should be selected.

And it is clear that the N.A. is of fundamental importance in determining the efficiency of a microscope.

7. Definition.

The *definition* of a lens is its capacity to render the outline of an object or image distinct to the eye, and depends partly upon the sufficiency of the correction for aplanatism, which can be assisted by the use of diaphragms, and partly upon the sufficiency of the correction for chromatic aberration: from which it follows that an achromatic lens has a better definition than a lens not so corrected.

The definition and resolving power of a lens are in practice tested by means of preparations of diatoms, those generally used for the purpose being *Pleurosigma angulatum*, *Grammatophora subtilissima*, *Navicula crassinervis*, *Surdrella gemina*, etc. With a good objective a very distinct image with sharply defined outlines will be obtained; in the case of *Pleurosigma angulatum* it should be possible to make out, under a magnification of 500–600 diameters, a central venule on to which two systems of oblique lines abut, crossing each other at an acute angle and forming a reticulated system of fine lines.

It is also well when testing an objective, to examine some small organism such as the *Bacillus tuberculosis*, in order to ascertain the magnification produced as well as the sharpness of the image.

8. Chromatic aberration—achromatism and apochromatism.

So far the conditions which must be fulfilled by a lens when homogeneous light is the illuminant have been considered. But in practice white or non-homogeneous light, *i.e.* light of different wave lengths, is used. And with white light a series of images will be formed of different colours, in different places, and of different sizes. Further, only one of these images corresponding to one definite wave length will be aplanatic. As will be readily appreciated, the calculations required for the correction of chromatic errors are of necessity extraordinarily complex; it must therefore suffice here to say that in practice chromatic aberration is corrected by the use of lenses combined in pairs (or triplets), one lens being concave the other convex. The convergent convex lens is made of *crown* glass, which has a low dispersive power, while the divergent concave lens is made of *flint* glass, which has a high dispersive power. By making these two lenses of a suitable curvature the chromatic aberration for two colours is corrected, and the lenses are said to be achromatized for those colours.

If ω denote the dispersive power of the glass between the F and C lines of the spectrum, and f denote the focal length of the lens, then, in order to achromatize the blue and red colours F and C, the couplet must be such that $\omega_2 f_1 = -\omega_1 f_2$.

In apochromatic (*ἀπο*, apart from; *χρῶμα*, colour) couplets, fluorite takes the place of crown glass. Fluorite has a similar relative dispersion to flint, so that with these couplets 3 (not 2) different colours can be achromatized. Suppose that in a given apochromatic system the focal lengths for the red, the yellow, and the green rays are the same: then the magnifications will be the same, but the images will not all lie in one plane. Again, suppose a system were so constructed that all the different colours should come to a

focus in the same plane: then the images would, though superposed, be of different sizes. And in order to correct as far as possible these defects, an under correction in one couplet is compensated by an over-correction in the next. Abbe's apochromatic oil-immersion objective is made up of ten lenses, as illustrated in the figure. Even then the achromatism is only carried out with regard to the position of the image, not to its size. Without entering

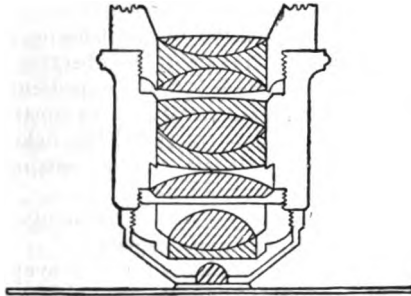

FIG. 109.—Abbe's apochromatic oil-immersion objective.

upon a discussion of the calculations necessary to determine the curvatures of the different lenses, it may be said that in practice if an objective be over-corrected, that is if the power of the flint glass be too great in proportion to that of the crown glass, the error may be rectified by slightly separating the lenses by means of a **compensating collar**: this has practically the effect of decreasing the power of the flint lens. Now if an object be examined under a microscope with an achromatic objective it will be found that the image has either a bluish outline or a yellowish outline. The former is the more common defect, and is due to over-correction, while the latter is a result of under-correction. Abbe's apochromatic objective being achromatic for three colours, is free from secondary spectra; since however the achromatism has regard to the position of the images, not to their sizes, the blue image though formed in the same plane as the red image is larger than the latter. This error is subsequently corrected by the **compensating ocular**, which produces larger red images than blue. Moreover the sine condition is attained for two colours so that each of these images is aplanatic, *i.e.* the image formed by these two colours is free from spherical aberration and coma. It will therefore be seen that no lens is, in the strict sense of the word, achromatic.

Apochromatic lenses with the necessary compensating eyepieces are very expensive, and are only necessary for special work. Ordinary achromatic objectives are quite sufficient for general purposes.

9. Flatness of image.

Even now all the defects of the image formed by a simple lens have not been studied, for it will always be found that the image is curved. To secure flatness of the image, a condition known as Petzval's condition must be satisfied.

Petzval's condition for flatness of image.—A couplet must satisfy the condition that

$$\mu_1 f_1 = -\mu_2 f_2.$$

But the essential condition for achromatism is

$$\omega_2 f_1 = -\omega_1 f_2.$$

It is necessary therefore to use glass with a high refractive index but low dispersive power to obtain an achromatic flat image. It is only recently that Messrs. Schott of Jena have succeeded in making such a glass—barium silicate glass—which produces a greater refraction and a smaller dispersion than crown glass.

B. The eyepieces.

An eyepiece is a system of lenses so arranged that the real image produced by the objective in the tube is magnified and transmitted to the eye of the observer.

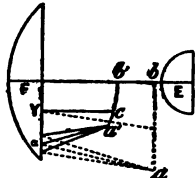

FIG. 110.—Theory of Huygenian eyepiece.

(To render the figure less complicated than it would otherwise appear, the principal plane is taken as on the flat side of the lens.)

In practice it is found expedient to form the eyepiece of two plano-convex lenses separated by an interval; the lower lens is called the field-lens, for it increases the field of view of the instrument, the upper lens is called the eye-lens.

The eyepiece most commonly used is that known as the **Huygenian eyepiece**.

In its simplest form this eyepiece consists of two plano-convex lenses—a field-lens F , and an eye-lens E . The focal length of the former f_1 is three times that of the latter f_2 . The curved surface of each lens faces the incident light, and the lenses are separated by an interval d which is twice the focal length of the eye-lens.

Thus

$$f_1 = 3f_2, \text{ and } d = -2f_2.$$

Let ba (fig. 110) represent the aplanatic image of the object formed by the objective. The field-lens of the eyepiece is placed below it, indeed half its focal length below it. Consequently the image ba is not actually formed, but the converging pencils proceeding towards the separate points of the image ba are made by the field-lens to converge towards the separate points of the image $b'a'$. Now since the cone of light that corresponds to any point of the image ba meets only an exceedingly small portion of the field-lens, we may neglect the aberrations which occur within each of these cones. Therefore we may regard each point of the image $b'a'$ as being fairly distinct; but it is necessary to consider in what way the spherical aberration of the field-lens will affect their relative positions. Now the field-lens may be regarded as consisting of several annular zones, the refracting power of each zone increasing with its distance from the centre. The axial ray of the peripheral pencil aa' will consequently undergo a greater deviation than that of the intermediate pencil such as γc . The consequence of this will be that the image $b'a'$ will be—

1. **Curved**, because the refracting power of the peripheral portion of the field-lens being greater than the more central portion, the focus a' of the peripheral pencil will be nearer the lens than the focus c of the intermediate pencil.
2. **Distorted**, for the peripheral parts of the image ca' will be smaller than the more central part $b'c$, i.e. the distortion is barrel-shaped (p. 109).
3. **Smaller** than the image ba .

In the majority of text-books the Huygenian eyepiece is also proved to be achromatic. But the proof is only applicable for incident *parallel* rays. The eyepiece does not give a strictly achromatic image of the objective's image, so that the proof is not worth considering. It has already been said that the apochromatic objective forms larger blue images than red. The compensating eyepiece having the eye-lens of a flint and crown glass combination forms larger red images than blue, and consequently the final image is completely achromatic.

It will be obvious from what has been said that there are so many errors to correct that it would appear well nigh impossible to correct them all. So would it be were it necessary to form a point image on the retina of each point of the object; fortunately the structure of the retina obviates this necessity. The smallest visual area of the retina is a retinal cone. In the

region of most distinct vision, the fovea, the cross section of a cone is a circular area of diameter $\cdot 002$ mm. Now if not more than one cone is stimulated the resulting impression will be that of a single point of light.¹ Therefore errors will be absolutely negligible if they give rise to such small confusion circles that they do not extend over more than one foveal cone.

SECTION III.—THE CARE OF THE MICROSCOPE.

The microscope must be kept at as uniform a temperature as possible and away from direct sunlight and all other sources of heat, because the lenses are held in position by Canada balsam, and they would be displaced and the instrument put out of order if the balsam were to be melted. It is also essential to protect the microscope from dust, which may best be done by standing it on a piece of thick felt or india-rubber on the bench, and covering it when not in use with a glass shade.

Objectives and eyepieces should always be wiped with a piece of soft linen before use, to ensure their being absolutely clean. If on looking down the microscope a speck of dust be seen in the field, one must find out where it is in order to wipe it off. To determine the position of the speck, first rotate the eyepiece; if the dust be on one or other of these lenses it will of course alter its position; and if rotation of the eyepiece do not alter its position, then it is on the objective. By holding the lenses up to the light some distance from the eye, it can be seen if they are cloudy or if specks of dust adhere to them.

To clean the front lens of the objective, rub it with an absolutely clean piece of fine linen; if this fail to clean it, take a piece of elder pith, strip off a thin layer, and with the clean surface so exposed gently rub the lens.

If cedar-wood oil, Canada balsam, or dammar varnish be sticking to the lens, moisten the cloth with a drop of xylol, and gently wipe the lens. An excess of xylol must not be used nor should xylol be poured on to the objective, for fear that it should penetrate between the lenses and their mountings and dissolve the balsam holding them in position.

When it is necessary to examine preparations in caustic potash, acids or other chemical reagent, great care must be taken to keep the lenses from coming in contact with the reagent: but if by accident the lens should be soiled, wash it at once in distilled water and dry with a soft linen rag.

If the objective be cloudy, and cleaning the outer lens does not remove the cloudiness, it must not be unscrewed to clean the inner lens, but should be sent to the maker, who is the only person capable of putting it right.

Objectives should be carefully protected against the slightest shocks or falls.

The eyepiece and the Abbe condenser can be cleaned in the same way as the objective, but these lenses are much more accessible and infinitely less delicate. The mirror can also be cleaned in the same way.

Before putting the microscope away, always wipe the eyepiece and objectives, and remove every trace of oil from the immersion lens.

The stand should be wiped frequently with a chamois leather, and rubbed in the direction in which the lacquer has been applied. Should the stand be accidentally soiled with balsam or cedar-wood oil, apply a little xylol on a soft cloth, and remove it at once with a chamois leather; if too much xylol be used or if it be not carefully wiped off it will dissolve the lacquer from the metal.

¹For simplicity of explanation the question of diffraction is ignored in this case.

A little xylol can also be used to clean the stage.

The coarse and fine adjustments should be lubricated from time to time by the application of a trace of vaseline.

SECTION IV.—METHOD OF USING THE MICROSCOPE.

1. The source of light.

The microscope when in use should rest on a firm table in front of a window. The best light for microscope work is that reflected from a white cloud, but the light may be taken also from a clear sky or a white wall. Direct sunlight is totally unsuitable.

In default of a satisfactory natural light, a good petrol-air or albo-carbon lamp may be used, though a lamp such as Ranvier's with an Auer burner is better. With these lamps it is sometimes necessary to interpose a sheet of ground glass between the source of light and the microscope to moderate the intensity of the former.

[Many observers prefer a small oil lamp, but for general use a very satisfactory artificial light is to be obtained by the use of an inverted incandescent gas mantle, the light from which is passed through a large flask filled with distilled water before reaching the mirror (fig. 111).]

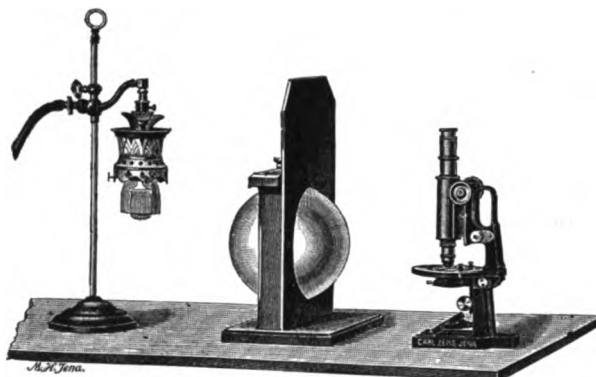

FIG. 111.—Illumination with an inverted incandescent gas burner.

Turn the microscope towards the source of light, look down the tube, and taking hold of the sides of the mirror move the latter about until the field is brightly illuminated.

1. With dry lenses use a concave mirror, which throws a convergent pencil of light on to the object.

2. When using an immersion lens, it is necessary to have an Abbe condenser fitted below the stage. *With a condenser a flat mirror must always be employed*; the rays reflected from the flat mirror are converged by the condenser and brought to a focus on the object, so that by the use of a condenser a considerable amount of light is obtained.

Every microscope should be provided with a diaphragm below the stage. The size of the opening in the diaphragm will be determined by the magnification employed; the greater the magnification the smaller should be the opening in the diaphragm. By cutting off the marginal rays—which are not only useless but actually detract from the sharpness of the image—the diaphragm assists in the correction of spherical aberration, and produces a sharper definition of the object.

2. Arrangement of the object.

The object to be examined under the microscope must be mounted on a microscope slide—a thin very transparent piece of glass free from bubbles of air—and may be covered with a cover-glass—a much thinner and smaller piece of glass, square or circular in shape, and measuring 18–25 mm. in diameter, but not exceeding 0.15–0.20 mm. in thickness.

The rays of light coming from the object as they pass through the cover-glass will be displaced to a greater or less extent, depending upon the thickness of the glass. Fig. 112 shows this. Given any point A on the object, its image on account of displacement will appear along the line DE, and will be diffuse; with [dry] high-power lenses especially, much of the brightness and sharpness of the image will be lost.

[To obtain perfect definition with the higher powers of the microscope, the thickness of the cover-glass is important, and for two reasons:

1. "If the cover-glass be very thick, there may not be room enough to bring the front lens sufficiently near to focus the specimen.

2. "The varying thickness of the actual glass introduces errors in the adjustment of the components of the lens system" (Spitta.)

To overcome this difficulty, it is only necessary to use cover-glasses of the thickness indicated on the objective, each objective being corrected to work for a given thickness. Or, since cover-glasses of exactly the same thickness cannot always be obtained, one may have objectives of certain magnifications, which can be corrected by altering the distance between the component lenses: the thicker the cover-glass the nearer must the lenses be together.

But now that all microscopes have a draw tube this correction is really not of vital importance, because by altering the length of the tube the effect of the thickness of the cover-glass can within certain limits be counteracted. The thicker the cover-glass the shorter must the tube be. With the draw tube right down in its socket, cover-glasses 0.25 mm. thick can be used, but with a normal length of tube (160–170 mm.) one must have cover-glasses no thicker than 0.15 to 0.18 mm.

3. Homogeneous immersion lenses.

Immersion lenses are used in order to counteract the refraction of rays of light in passing from glass to air. In using an immersion lens a drop of some liquid, the refractive index of which is as nearly as possible the same as that of glass, is placed on the cover-glass, and the lens lowered into it. Cedar-wood oil has a refractive index of 1.515 to 1.520, a mixture of castor oil and essence of anise about 1.510, and monobromonaphthaline 1.66. Homogeneous immersion objectives do not need to be corrected.

When rays of light pass from the cover-glass into air, their direction is altered in such a manner that all rays making with the surface of the cover-glass a smaller angle than $[48^\circ 12']$ are totally reflected and are lost to the objective. By substituting a substance of the same refractive index as glass for air, this loss of light is avoided. An immersion lens makes the image very much [brighter and] sharper; so that an homogeneous immersion objective whose angle of aperture measures 82° has the same value (*i.e.* numerical aperture) as a dry lens whose angle of aperture is $180^\circ (\mu \sin U)$ (p. 112). Moreover for the same magnification an immersion objective has a greater focal length than a dry lens.

It is necessary to use an Abbe condenser with an immersion lens, and perfect results can only be obtained with a given length of tube (generally 160–170 mm.). A drop of cedar-wood oil is placed on the cover-glass, and the objective is lowered until its front lens touches the oil.

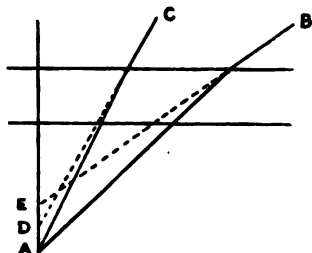

FIG. 112.—Displacement of the rays of light as they pass through the cover-glass.

Immersion lenses should be used only with stained preparations. They are not suitable for the examination of unstained preparations, because the light focussed by the condenser is so intense that it drowns unstained objects and renders their outline very indistinct.

4. The nosepiece.

The nosepiece in most general use is constructed to carry three objectives—usually a No. 2, and a No. 8 or No. 9 dry, and a $\frac{1}{12}$ th homogeneous immersion lenses. Each objective is screwed into its proper place in the nosepiece, which is marked for the purpose; it is necessary that this be done in order to get the centering true. By simply rotating the nosepiece, it is thus possible without unscrewing them to use any of the objectives.

5. Eyepieces.

In the great majority of cases a low-power eyepiece should be used. A high-power eyepiece only magnifies at the expense of brightness and sharpness (p. 113). Eyepieces I. or II. are generally used, III. and IV. only when delicate work requiring considerable magnification is in hand.

6. Focussing.

Focussing is done in two stages. The object is first brought approximately into focus with the coarse adjustment, and then sharply focussed by means of the fine adjustment.

The focal length varies with the different objectives, being in inverse ratio to the magnification. The approximate focus for each objective is soon learnt with a little practice, so that the first stage of the process is quickly done.

The object having been brought more or less into focus with the aid of the coarse adjustment, is exactly focussed by means of the fine adjustment working on a micrometer screw.

When high powers are used the objective will be close to the cover-glass, and a rough movement downwards of the lens will most certainly break the slide. [Microscopes are now made so that it is impossible to force the objectives through the cover-glasses.] In any case, to avoid this possibility proceed as follows:

1. Before looking down the microscope, fix the eye on the preparation, and lower the tube slowly with the coarse adjustment until the front lens touches the cover-glass.

2. Now look down the tube, and raise the coarse adjustment until the preparation is approximately focussed.

3. Then get the exact focus by gently rotating the fine adjustment.

The fine adjustment should never be used for large alterations of focus; it is a very sensitive and delicate screw, acting on the microscope tube through a spiral spring, which would soon be put out of gear if used for large excursions.

While the fine adjustment is being used, the thumb and index finger of the right hand should not be taken off the micrometer screw, but should continually move it backwards and forwards gently, until, without any effort of accommodation, the different parts of the preparation are brought into focus and seen in succession, and the shape of the object distinctly made out.

While examining a preparation, the slide should be held between the thumb and index finger of the left hand, and moved about on the stage, so that the different parts can be brought within the field as required. [It is a great advantage to have a "mechanical stage" fitted to the microscope;

this enables the observer by turning a milled screw to place with ease and accuracy any portion of the slide under the objective, and by continuous rotation, rapidly to examine the whole preparation.]

SECTION V.—THE MEASUREMENT OF MICROSCOPICAL OBJECTS.

1. The experimental determination of the magnification produced by a system of lenses.

Magnification produced by an optical system is of course magnification in diameters.

Microscope makers supply a table with each of their instruments, showing with a given tube length the magnification produced with every combination of objective and ocular. This table may be verified roughly by one or other of the two following methods:

A. With a camera lucida.—For this purpose a camera lucida and a stage micrometer are necessary. A stage micrometer is a thin glass slide, on which a scale mechanically divided by parallel lines into $\frac{1}{100}$ ths of a millimetre has been engraved.

1. Select the eyepiece and the objective of which the magnification produced by the combination is to be determined. Lengthen the tube to 160 mm., or whatever is the proper working length. Place the micrometer slide on the stage and get it into focus, so that the divisions on the scale are sharply defined.

2. Place a sheet of paper, bluish for choice, on a small drawing table level with the stage of the microscope on the right-hand side of the instrument. Fit the camera lucida to the eyepiece.

3. On looking down the tube of the microscope, two images of the scale on the micrometer will be seen—one formed directly by rays passing through the camera lucida, the other projected by reflection at the prism on to the paper. If the image projected on to the paper be approached with the point of a pencil, the latter will also come into view, and it will be easy to outline on the paper the position of the image of the scale on the micrometer. Trace the position of a few of the divisions of the scale.

4. With a millimetre scale measure the distance between any two of the lines sketched.

Let n = the distance in millimetres of two adjacent divisions, and M = the magnification of the optical system employed.

Since the scale on the micrometer slide is divided into $\frac{1}{100}$ mm., it follows that

$$n = \frac{1}{100}M$$

$$M = 100n.$$

Suppose, for instance, the distance between two adjacent lines on the paper be 5 mm. The magnification produced will be 100×5 . This is expressed by saying that the magnification is 500, or to be more accurate 500 diameters.

The magnification produced by an optical system can also be determined by simply projecting the magnified divisions of the micrometer directly on to a millimetre scale arranged on the same level as the microscope stage.

Then, if n denote the number of divisions on the scale occupied by m divisions on the micrometer,

$$\text{the magnification is} = 100 \frac{n}{m}.$$

Suppose for example that three divisions of the micrometer occupy fifteen divisions on the millimetre scale, then the magnification is $= 100 \times \frac{1}{3} = 500$.

This is a simple and convenient method but the results are only approximate, the magnification being somewhat exaggerated.

B. With the ocular micrometer.¹—An ocular micrometer consists of a small circle of glass on which a scale divided into $\frac{1}{10}$ mm. is engraved. The ocular micrometer is placed between the eye and field lenses of the eyepiece.

The magnification of the eyepiece being known (generally 10 diameters), each division of the scale as seen through the eyepiece is equal to $\frac{1}{10} \times 10$ mm. = 1 mm.

1. Place the stage micrometer on the stage of the microscope, drop the ocular micrometer into the eyepiece, and turn on the objective to be examined. Adjust the tube to the proper working distance and focus the scale on the stage micrometer, then arrange the latter so that any two lines on it coincide with any two lines on the ocular micrometer.

2. Determine how many divisions of the ocular micrometer are covered by one division of the stage micrometer, and let n be the number.

The magnification produced is given by

$$M = 100n;$$

and if five divisions of the ocular micrometer are covered by one division of the stage micrometer, the magnification is $= 5 \times 100$.

2. The measurements of objects under the microscope.

The standard adopted for microscopical measurements is the one-thousandth part of a millimetre, which is designated by the Greek letter μ ; the *Bacillus tuberculosis* for example is said to measure 1.7 to 3.5 μ long by 0.2 to 0.5 μ broad.

Two different methods may be employed for measuring microscopical objects.

A. Camera lucida method.—1. First ascertain the magnifying power of the system of lenses to be used by means of the objective micrometer and camera lucida (p. 121).

2. Substitute the slide on which the object to be measured is mounted for the stage micrometer, and an outline of the object will be thrown on a sheet of paper arranged as for the preceding determination.

3. Measure the length of the outline in millimetres, and let n be the length.

4. Then, the magnifying power m of the combination of lenses being known, the diameter D of the object is easily determined from the equation

$$D = \frac{n}{M}.$$

Let us suppose the magnifying power of the optical system to be 500 diameters,

[¹ Hermann, Whittaker, and Young warn against the use of an Huygenian eyepiece with a micrometer. Ramsden's is the only eyepiece that can be relied upon. Clearly a micrometer scale put between the lenses of an Huygenian eyepiece will only be magnified by the eye lens and will therefore undergo "pincushion" distortion. But the image of the stage micrometer at that place has "barrel-shaped" distortion which is rectified by the "pincushion" distortion produced by the eye lens.

[The object must be in the centre of the field, as towards the periphery "pincushion" distortion would be more marked.

[Using the same microscope measurements made with the same combination of lenses are comparable among themselves but are not comparable with measurements made with any other microscope nor with the same microscope and any other combination of lenses.]

and the greatest diameter of the outline of the *Bacillus tuberculosis* as sketched with the camera lucida to be 1.5 mm. : then, from the formula

$$D = \frac{1.5}{500} = 0.003 \text{ mm.} = 3\mu,$$

we find the length of the tubercle bacillus to be 3μ .

A table can be readily drawn up showing the magnification obtained with any combination of lenses, and such a table will save considerable time in the measurement of microscopical objects.

B. Measurement with the ocular micrometer [see footnote p. 122].—1. The stage micrometer is examined through the ocular micrometer, and the number of divisions on the ocular micrometer corresponding to one on the stage micrometer determined for each objective. For example, supposing that with objective No. 8 one division of the stage micrometer cover five divisions on the ocular micrometer, then five divisions on the ocular micrometer are equal to $\frac{1}{100}$ mm., and one division to $\frac{1}{200}$ mm., that is to 2μ .

2. Replace the stage micrometer by the object to be measured. Suppose it occupies n divisions on the scale.

3. Now, knowing that one division is equal to 2μ , and using D to denote the diameter of the object,

$$D = n \times 2\mu.$$

If the object cover for example two divisions, then

$$D = 4\mu.$$

Note.—A table giving the value of each division of the ocular micrometer when used with any objective can be drawn up. It is then only necessary to multiply this figure by the number of divisions occupied by an object. For example, using Reichert's lenses—

| | | | |
|----------------------|---|---|--------------|
| With objective No. 2 | one division on the ocular micrometer scale | = | 27μ . |
| " | No. 4, " " | " | = 11μ . |
| " | No. 8, " " | " | = 2.2μ . |
| " | No. 9, " " | " | = 1.9μ . |
| " | $\frac{1}{2}$ th, " " | " | = 1.8μ . |

Thus: Suppose, using objective No. 8 (Reichert), an object covers two divisions on the ocular micrometer; then

$$D = 2.2\mu \times 2 = 4.4\mu.$$

Similarly, an object seen through a $\frac{1}{2}$ th immersion lens covers three divisions; then

$$D = 1.8\mu \times 3 = 5.4\mu.$$

It will be readily understood that the higher the magnification the more exact the measurement. With high powers the errors of observation are reduced.

SECTION VI.—DARK-GROUND ILLUMINATION.

It has already been shown (p. 113) that it is impossible even with the best microscopes to distinguish, *i.e.* to resolve, any two points less than about 0.1μ apart, or to see any details of smaller dimensions than 0.1μ .

To render small delicate objects more readily visible under the microscope, Siedentopf and Zsigmondy have utilized the fact that very fine particles placed on a dark back-ground and powerfully illuminated are rendered much more easily visible than when examined on a brightly illuminated surface. Everyone is familiar with this fact in connexion with the stars—the darker the night the brighter the stars. This is the whole principle of [the dark-ground illuminator, or, as it sometimes unfortunately is termed] the ultra-microscope. *The dark-ground illuminator does not increase the resolving power*

of the system of lenses, but merely illuminates particles when on a dark background and so renders them more easily visible.

The researches of Siedentopf and Zsigmondy, afterwards extended by Cotton and Mouton, have been taken up by optical instrument makers, who have constructed and are daily improving the apparatus necessary for dark-ground illumination.

1. The application of dark-ground illumination to micro-biology.

Whatever the form of apparatus employed, the dark-ground illuminator does not appear likely to be of assistance in the study of infinitely small things, such as the so-called "invisible micro-organisms," [for the simple reason that objects less than 0.1μ are not resolved. They are seen just as stars are seen, which subtend no appreciable angle, but are visible because their image forms such an intensely bright point of light on part of the apex of one retinal cone that they become visible. Such minute objects appear as bright points in the field of vision surrounded by light and dark diffraction rings; they have neither shape nor form.]

The instrument is, however, of considerable practical value in that it affords more favourable conditions than are obtainable with the ordinarily illuminated microscope stage for the examination of material in the fresh unstained condition. The dark-ground illuminator renders cells and organisms easily visible in the living condition with their natural movements unimpaired. The valuable aid afforded by the instrument in the rapid diagnosis of certain micro-organic diseases, and particularly of syphilis, has been demonstrated by Landsteiner and Mucha, by Gastou and others.

2. The construction of the dark-ground illuminator.

The essential features of the dark-ground illuminator.—The dark background and the powerful illuminant that it is necessary to apply can be realized in several ways.

A. Zeiss' diaphragm.—The simplest and cheapest method—sufficient moreover in the majority of cases for purposes of clinical diagnosis—is to use an

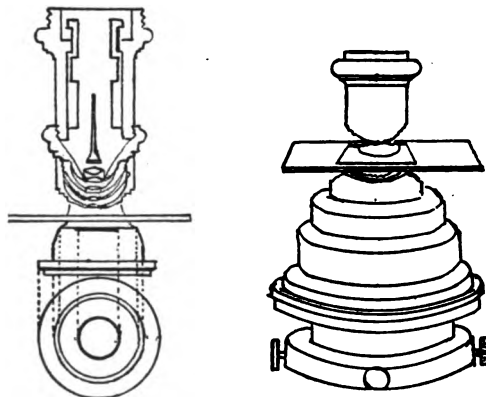

FIG. 113.—Dark-ground illuminator for fixing below the stage.

ordinary microscope fitted with an Abbe condenser (N.A. 1.40), a dry lens (7 or 8) and a high eyepiece (Zeiss' 12 or 18 compensating ocular): the

apparatus for dark-ground illumination consists of a special diaphragm which is placed below the condenser. Slides and cover-glasses of a given thickness, varying with every condenser, are essential.

B. Special condensers.—In these cases the ordinary Abbe condenser is replaced by a prismatic condenser (Cotton and Mouton), a parabolic condenser (Zeiss) or a spherical condenser (Leitz) arranged in such a way that the rays reflected by the mirror are deviated, so that they pass obliquely through the film of liquid which is placed between the slide and cover-glass, and cannot enter the objective. Under these conditions any particles held in suspension in the preparation on the stage of the microscope are lighted from the sides while the back-ground is obscure.

In most patterns the dark-ground condenser is placed below the stage

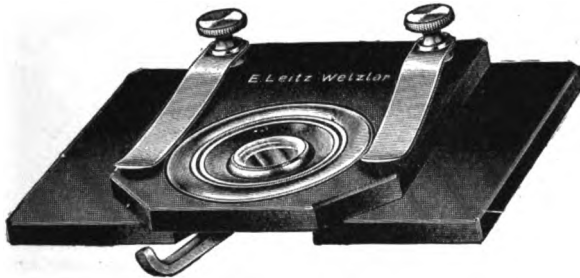

FIG. 114.—Dark-ground illuminator for fixing on the stage.

in the collar generally used for the Abbe condenser, but instruments are now made to fix on the stage of the microscope.

These latter are the better, and they can be used either with a dry lens or with an immersion lens.

3. Method of using the dark-ground illuminator.

To use dark-ground illumination it is necessary to have :

1. A powerful source of light ;
2. A lens to form the image of this source on the mirror ;
3. A firm microscope stage on which to fix the dark-ground illuminator, an objective and an eyepiece.

These are all arranged on a rigid table, and it is an advantage to have an optical bench 1 metre long.

A. The source of light.

The specific intensity of the light increases the visibility of the objects under the microscope. A Nernst lamp, an arc lamp or an inverted incandescent gas burner are the sources of light generally used. Electric light is perhaps better, but an Auer burner (inverted incandescent) (p. 118) is quite good enough for most purposes.

Sometimes it is necessary to use sunlight, and particularly when photographing objects under the ultra-microscope. For this purpose the apparatus is arranged in a dark chamber, and the rays of light falling on an heliostat worked by clock-work pass into the chamber through an opening made in the shutter of the window.

Whatever the pattern of apparatus used, the rays of light must be condensed by a lens on to the flat surface of the microscope mirror.

Sometimes it is better to use instead of a lens a large round flask filled

with water lightly tinted with copper sulphate, an arrangement which has the advantage of absorbing the heat rays and so prevents deterioration of the preparation from that cause.

The image of the source of light must be formed on the mirror: to secure this, a sheet of white paper may be placed upon the surface of the mirror

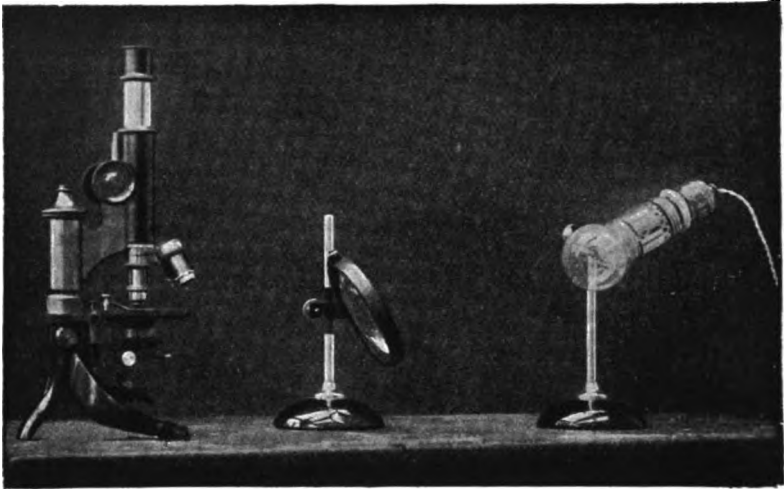

FIG. 115.—Illumination with Nernst lamp and lens.

which is then moved about until the image is clearly defined. The mirror should be uniformly illuminated and the whole surface covered with light.

To get the light arranged satisfactorily requires prolonged manipulation, so that for clinical work where time is an important consideration the apparatus should be arranged beforehand. It is of great advantage in this connexion to have an optical bench, for with it the respective positions of the light, the lens and the microscope can be found once for all. Roughly speaking, the lamp, the lens and the mirror are placed at a distance of 15 to 20 cm. from one another according to the apparatus used. The tube of the microscope should be vertical.

B. Centering.

The dark-ground illuminator, whether placed on the stage of the microscope or arranged in the place of the Abbe condenser, must be centered. The method by which this is done will depend upon whether the apparatus is above or below the stage.

(a) Dark-ground illuminators fixed in the collar ordinarily carrying the Abbe condenser must be so arranged that the lower flange is close up against the collar, and the upper surface just below the upper surface of the stage.

Using a low-power objective and looking down the tube of the microscope, the centre of the apparatus should be brightly illuminated without shadows or halos. If the field be not bright, adjust the lateral screws (fig. 113) until the lighting appears quite uniform.

(b) In those forms which are made for use on the stage, first fix the apparatus with the clips and then, using a low-power objective and looking down the tube, take hold of it on each side with thumb and finger and move it about gently until the centre appears brightly and uniformly illuminated.

C. Arrangement of the preparation to be examined.

1. The preparation to be examined should be mounted on a slide and covered with a cover-glass.

(a) The slide should be of crystal glass free from flaws and absolutely clean, because any dust or dirt will seriously interfere with the observation.

Slides and cover-glasses should be washed in acid rinsed in distilled water and kept in alcohol (p. 130). When required for use, it is advisable in order to ensure cleanliness to paint the slide with a layer of collodion, which can be peeled off just before it dries.

Dust which falls on the cover-glass during the examination interferes with the satisfactory lighting of the preparation, and if the observation be prolonged the cover-glass should be washed or dusted from time to time.

(b) To secure the most satisfactory illumination the slide should be of a thickness suitable to the particular apparatus in use (all dark-ground condensers are marked with a number indicating the thickness of slide to be used—generally about 1.4 mm.). When working with sunlight it is absolutely necessary that slides of the exact thickness indicated on the condenser should be used; but with the sources of light ordinarily employed this precision is of less importance, and one-third of a millimetre one way or the other is a matter of no great moment.

The thickness of the cover-glasses should correspond with the correction of the objective (p. 119).

2. There should be continuity between the media through which the light passes, so that refraction may take place under the best conditions; a large drop of very fluid immersion oil should therefore be placed between the condenser and the slide.

An inferior quality of oil is a frequent cause of failure. The oil should be quite fluid, absolutely homogeneous, contain no air bubbles, and be used in sufficient quantity to completely fill the space between the lens and the condenser.

3. The film to be examined should be as thin as possible, uniform and free from air bubbles. If the material be sufficiently fluid and viscous to keep the slide and cover-glass together the preparation may be examined without any addition. In the contrary case, dilute the material in a drop of blood serum, aqueous humour or ascitic fluid; water or normal saline solution may be used but these solutions have the disadvantage that they alter the shape and interfere with the vitality of the cells.

If the experiment is to be prolonged it is advisable to lute the edge of the cover-glass with a little vaseline or paraffin to prevent evaporation.

D. Focussing the microscope.

For dark-ground illumination work a dry lens (No. 7, 8, or 9) may be used (though an immersion lens is better) and a high eyepiece (No. IV. or Zeiss' compensating ocular 18).

To obtain a quite black background, special objectives can be employed in the mounting of which a carefully centered diaphragm is suspended to intercept marginal rays: these objectives (Leitz, Zeiss) give remarkably distinct images.

A certain amount of skill which can only be obtained with practice is required to get satisfactory results.

1. **With a dry objective.**—The lighting being satisfactory, the apparatus centered and the preparation fixed with the clips, the eye is applied to the tube of the microscope which is then slowly lowered. At first there is a

certain amount of diffused light, but this soon gives place to complete darkness; by continuing carefully to lower the tube, the back-ground will suddenly become lit up in places and dotted with bright points; the preparation is then focussed.

2. With an oil-immersion lens.—Place a drop of cedar-wood oil on the cover-glass and lower the tube until the lens touches the oil. Then with the mechanical adjustment gently raise and lower the tube until the back-ground is illuminated with bright spots.

If the field be unequally lighted or if it be narrowed by shadows, the centering is at fault and must be corrected by careful manipulation of the dark-ground condenser (p. 126).

E. Appearances seen in the field under dark-ground illumination.

When the lighting and centering are satisfactory, and the object focussed, luminous points and spots of different appearances—motile or non-motile—will be seen corresponding to the microscopical objects (micro-organisms, cells, particles of colloid matter, etc.) in the preparation. Certain non-motile



FIG. 116.—Preparation showing spirochetes, leucocytes and red cells (after Gastou).

spots, generally taking the form of rosettes or flocculent masses, may be seen; these are merely flaws in the glass and must not be confused with the objects in the preparation. [This generalization of course only applies when the size of the objects is greater than the resolving power of the combination of lenses employed. Any objects in the field which are beyond the resolving power of the combination of lenses will appear as bright spots with light and dark diffraction rings and the size of the objects which will appear as such will depend upon the intensity of the illumination. It has already been pointed out that the so-called ultra-microscope or dark-ground illuminator does not increase the resolving power of the microscope, hence whatever the shape of the object if it be so small as to be below the resolving power of the system of lenses used it will appear as a bright dot surrounded by rings.]

It will be found easy to study the movements (Brownian movements, movements of propulsion, etc.) of the different corpuscles. In interpreting these it must not be forgotten that an universal movement of the illuminated

elements in the same direction is due to currents set up in the preparation.

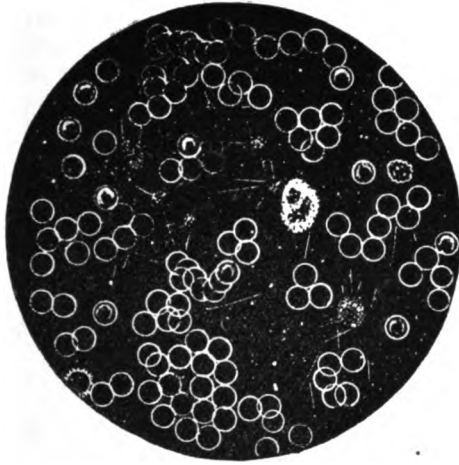

FIG. 117.—Preparation showing red blood cells, hæmatoblasts and strands of fibrin (after Gastou).

Lastly it cannot be too strongly emphasized that the smallest trace of dust on the slides or cover-glasses interferes materially with the examination of the preparation.

CHAPTER VIII.

THE MICROSCOPICAL EXAMINATION OF CULTURES OF MICRO-ORGANISMS.

Introduction.

Section I.—The preparation of slides and cover-glasses, p. 130.

Section II.—The examination of unstained preparations, p. 131.

Section III.—The examination of stained preparations, p. 135.

1. Staining solutions, p. 137.
2. Simple staining, p. 140.
3. Gram's stain, p. 142.
4. Claudius' method, p. 144.

CULTURES should be examined microscopically in two ways.

(a) An unstained preparation of the living organisms should first be examined. By this means not only can the shape of the organisms be determined but also whether they are motile or not, and if motile the nature and rapidity of the movements.

(b) Secondly, the morphological study of an organism must be completed by the examination of stained preparations, which will allow a more detailed study of its structure with the higher powers of the microscope.

For the preparation of objects for the microscope a supply of clean slides and cover-glasses is essential, and the methods of preparing these may first be described.

SECTION I.—THE PREPARATION OF COVER-GLASSES AND SLIDES.

The essential qualities of cover-glasses and slides have already been mentioned (p. 119). Before being used they must be carefully cleaned.

1. Cleaning of cover-glasses and slides.

A. New cover-glasses are more or less greasy and cannot be moistened with water. Before using them therefore wash them in 95 per cent. alcohol, and wipe with a piece of soft smooth-surfaced cloth; then to get them perfectly clean they must be passed several times through the heating flame of a Bunsen burner.

In wiping a cover-glass never hold it in both hands because it will certainly be broken, but hold it between the folds of the cloth with the thumb and first finger of the right hand, and rub it gently.

It is convenient to have a wide-mouthed ground-glass stoppered pot on the bench containing 95 per cent. alcohol in which to keep a stock of cover-glasses, so that they can be taken out and dried as wanted.

Slides similarly should be carefully washed in alcohol and dried.

B. Slides and cover-glasses can be used over and over again. They must however be carefully cleaned to remove all traces of material on them; unless this be properly done mistakes are likely to occur when they are used a second time. The thorough cleaning of soiled slides is therefore of great importance and can be done as follows :

1. Drop all used slides and cover-glasses when they are finished with into a dish containing spirit.

2. When a number have collected put them into a porcelain dish, cover them with a 4 per cent. solution of sodium carbonate and boil for half an hour.

3. Pour off the soda solution, wash in a large volume of water, then drop them into the following solution :

| | |
|---------------------------------|-------------|
| Water, - - - - - | 1000 grams. |
| Potassium bichromate, - - - - - | 50 " |
| Sulphuric acid, - - - - - | 100 " |

and boil again for half an hour.

4. Pour off the bichromate solution, wash again in a large volume of tap water, then in distilled water, wipe them dry and drop them one by one into covered pots filled with 95 per cent. alcohol, out of which they can be taken as required.

This method will ensure the glasses being clean.

2. Method of using cover-glasses and slides.

Cover-glasses should be picked up by one of their angles with a pair of Cornet's (fig. 118) or Debrand's (fig. 119) forceps.



FIG. 118.—Cornet's forceps.

Debrand's forceps, a very useful modification of Cornet's, are well balanced and easily held in the hand: they give a firm hold and do not break the cover-glasses.



FIG. 119.—Debrand's forceps.

SECTION II.—THE EXAMINATION OF UNSTAINED PREPARATIONS.

A little drop of a culture of a micro-organism may be mounted between a slide and cover-glass and examined. But to keep the organisms alive while they are being examined for the purpose of studying the method of multiplication, etc., special slides having a small concavity or cell ground in their centre, are used. A drop of broth is placed in the cell and sown with the organism; in this way a living culture is available for the purposes of microscopical examination.

1. Examination of a culture on an ordinary slide.

A. Cultures in fluid media.—1. Prepare an absolutely clean slide and cover-glass.

2. Aspirate a few drops of the culture into a Pasteur pipette, taking care of course not to introduce contaminations.

3. Pick up a cover-glass by one of its corners with a pair of Cornet's forceps, and let fall a drop of the liquid from the pipette on to the centre of the cover-glass.

4. Invert the cover-glass on to a slide and the drop will spread out in a thin layer. One must be careful not to introduce any air bubbles as these would interfere with the subsequent examination.

5. Place the preparation on the stage of the microscope and examine with a No. 8 or No. 9 objective and a No. I. or No. II. eyepiece. If the examination is likely to be prolonged the edges of the cover-glass can be luted with paraffin in the following manner: Soak up the excess of culture fluid which has exuded from the edges of the cover-glass with a cigarette paper or piece of filter paper: then apply a heated iron rod—it is better to use a special instrument such as that shown in fig. 120—to a block of paraffin, so as to



FIG. 120.—Instrument for luting with paraffin.

melt a little of it: in doing this some of the paraffin will adhere to the rod and can be transferred to each of the corners of the cover-glass to fix it in position. Then by taking up some more paraffin on the rod the edges can be luted.

The pipette with which the culture was removed should not be used again. Pipettes which have been in contact with a culture must never on any account be laid on the bench. All pipettes after use should be put into a metal vessel, and when the experiment in hand is completed sterilized either in the autoclave or more readily by boiling for a few minutes: only then can they be safely thrown away.

B. Cultures on solid media.—1. Take a cover-glass in a pair of forceps, and put a little drop of recently filtered water (Chamberland filter) or sterile broth in its centre.

2. Open the culture-tube in the ordinary way, take up a trace of the culture on a platinum wire and re-plug the tube.

3. Make an emulsion of the culture in the drop of water on the cover-glass with the wire. Flame the wire.

4 and 5. As above.

A common mistake is to remove too much of the culture. If more than a trace be taken, there will be too many organisms in the field of the microscope and the examination of them will be exceedingly difficult. It cannot be too clearly understood that the fewer the organisms the better can their shape, movements, etc., be studied.

2. Hanging drop preparations.

By using a hollow-ground slide any organism under examination can be kept alive for a long time and its development studied.

(i) The technique of the hollow-ground slide.

There are many patterns of slides or cells for use with the microscope.

A. Koch's hollow-ground slide.—This is simply a slide of the ordinary size

having a circular cup-shaped hollow about 15 mm. in diameter ground in its centre (fig. 121). Sterilize the slide as well as the cover-glass with which

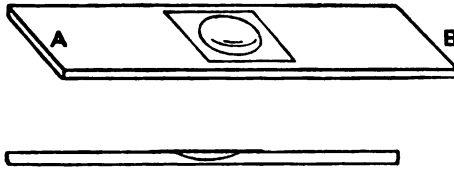

FIG. 121.—Koch's hollow-ground slide.

it is to be covered by rapidly passing them through the flame several times just before they are about to be used.

(a) In the case of cultures already incubated, take a drop of the culture and place it in the centre of the previously heated and cooled cover-glass, invert the cover-glass over the hollow in the slide and ring the edges with a little vaseline to prevent evaporation. The drop of culture hangs from the lower surface of the cover-glass into the cavity ground in the slide.

The drop of culture placed on the cover-glass should be small enough to prevent it touching the sides of the cavity otherwise the liquid will run by capillarity between the slide and cover-glass and the hanging drop will disappear.

When examining a hanging drop under the microscope great care must be exercised in lowering the tube, because the cover-glass is only supported at its edges and the least pressure on it will break it. It is best to use a No. 8 or No. 9 objective and No. I. or No. II. eyepiece (Reichert's lenses).

The small quantity of air contained within the cell is quite sufficient to provide all the oxygen necessary for several days.

(b) Most frequently a hanging drop is used to study the development of an organism. In this case the culture must be sown in the cell. It can be done thus: Put a drop of sterile broth or sterile aqueous humour on the cover-glass and sow it with the organism under investigation.

It is absolutely essential in doing this that only a very few organisms be sown. A trace of the culture may be picked up on the end of the straight wire and the drop then very lightly touched with the latter, but it is better to adopt the dilution method: thus, sow a broth tube (No. 1) with a loopful of the culture and shake; sow a second broth tube (No. 2) with one or perhaps two drops from tube No. 1, and then transfer a drop of the broth from tube No. 2 to the cover-glass to form the hanging drop. If tube No. 2 still contain too many organisms, sow a third tube (No. 3) with a few drops from No. 2. The hanging drop is then made with a drop of broth from No. 3.

The successive steps, then, are as follows:

1. Flame the slide and cover-glass and allow them to cool.
2. Place a drop of sterile broth in the centre of the cover-glass and sow it with a trace of the culture (or, better, take a drop of broth from a tube sown by the dilution method).
3. Invert the cover-glass on the hollow-ground slide and lute the edges with paraffin.
4. Examine the hanging drop on a warm stage (*vide post*), or if a warm stage be not available, incubate it in the ordinary incubator and examine at frequent intervals on the ordinary stage, using a No. 8 or No. 9 objective and a No. I. or No. II. eyepiece. Make certain that at the time when the hanging drop is made there are not more than two or three organisms in each field of the microscope.

The culture can be kept for examination for 1 to 3 days. The air present

in the cell is generally quite sufficient for the growth of the organism during this period.

To improvise a hollow-ground slide.—A hollow-ground slide may be improvised by taking a rectangular piece of pasteboard about 3×2 cm. and 1.5 to 2 mm. thick, and cutting out of its centre a small piece about 15 mm. square. Sterilize the piece of pasteboard in the autoclave at 115° C., take it out with a pair of sterile forceps and lay it on a slide which has been passed through the flame: the cover-glass on which the drop of fluid is placed can be inverted on this to form a hanging drop.

B. Böttcher's cell.—This cell consists of a glass slide on to which a glass ring (15–20 mm. in diameter and 5 mm. deep) is stuck (fig. 122). The cover-

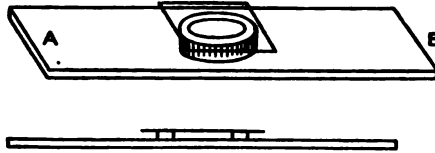

FIG. 122.—Böttcher's cell.

glass carrying the hanging drop is inverted on to the ring. A little drop of water should be put in the bottom of the cell to prevent evaporation of the culture medium.

C. Ranvier's cell.—In the foregoing cells the hanging drop has a spherical lower surface, with the result that the rays of light passing through it are refracted at points which are not equally distant from the lens, and this to some extent interferes with the examination of the preparation. For delicate work it is better to have the two surfaces of the liquid under examination parallel to each other. This can be attained by using Ranvier's cell (fig. 123),

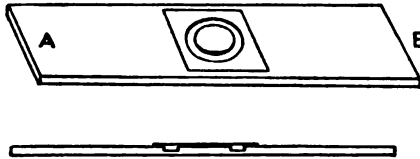

FIG. 123.—Ranvier's cell.

which consists of a rather thick glass slide having a circular groove 15–20 mm. in diameter running round its centre marking off a central elevation which it surrounds on all sides like a moat. The upper surface of this elevated central part is about $\frac{1}{10}$ th mm. below the surface of the slide. The drop of liquid, being placed on the central elevation and covered with a cover-glass, is flattened out between the elevated part and the cover-glass, and forms a layer $\frac{1}{10}$ th mm. deep surrounded on all sides by the air in the groove; the edges are luted and the subsequent procedure is the same as in the foregoing cases.

(ii) **The cultivation and preservation of hanging drop preparations.**

To grow an organism under these conditions it is necessary to keep it at the temperature best suited to its growth, which in the majority of cases is 37° C. This may be done by keeping the slide in the incubator, taking it out when required for microscopical examination; but it is better to maintain the slide at the temperature required on the stage of the microscope itself,

by making use of some form of **warm stage** for the purpose, Vignal's for example (fig. 124) or Malassez's or Ranvier's. These really are small incu-

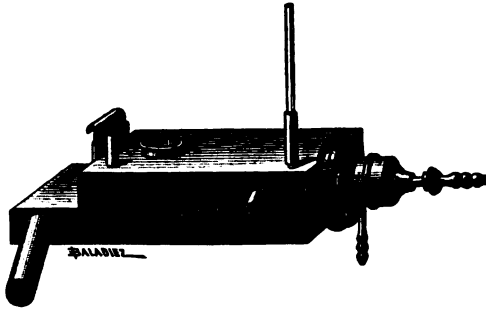

FIG. 124.—Vignal's warm stage.

bators, allowing of the examination of the culture through a circular aperture cut in the apparatus.

Pfeiffer's warm stage is simpler than those already mentioned and serves the same purpose. It consists of a rectangular glass box (fig. 125A), the upper surface of which is hollowed out to form a cell, in which the culture is placed. The box is filled with water and is connected by means of two lateral tubulures to a thermostat. The temperature is indicated by a thermometer placed as shown in the figure.

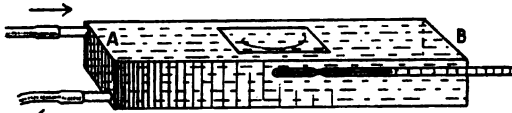

FIG. 125A.—Pfeiffer's warm stage.



FIG. 125B.—Pfeiffer's stage in section.

The apparatus is placed on the stage of the microscope like an ordinary slide.

By another method the lower part of the microscope is enclosed in a box—a small incubator—which entirely surrounds the stand; the box has a window for lighting purposes and lateral openings to allow of the preparation being moved (Zeiss, Plehn). The apparatus is fitted with a regulator and is heated by a gas burner. The temperature must not exceed 45°C ., to avoid injury to the microscope.

SECTION III.—THE EXAMINATION OF STAINED PREPARATIONS.

Staining methods allow a more detailed study of the morphology of micro-organisms than is possible with unstained preparations, and furnish important data for the diagnosis of species. For different species of bacteria do not react in the same way to stains: some are readily stained and cannot be decolourized with alcohol, others which stain with equal readiness lose the

stain in alcohol, while a third group stain with difficulty but after being stained resist the action of the most powerful decolourizing agents.

Bacteria are vegetable cells of which the greater part is occupied by the nucleus (Bütschli): they stain with those dyes which stain the nuclei of vegetable cells, that is to say, the **basic aniline dyes**.

Stains.—Ehrlich divided dyes according to their action on cells into two groups: *basic dyes* and *acid dyes*.

Basic dyes are those in which the staining property depends upon a base combined with a colourless acid. They are called selective dyes, because they exhibit a marked selective affinity for nuclei and especially the nuclei of vegetable cells. The basic dyes are the true micro-organic dyes. Those most commonly used are the following:

| | | |
|--------------------|---|--|
| Violets, - - - | { | Crystal-violet. Thionin (Lauth's violet). Gentian-violet. Methyl-violet B (Bâle's violet). Methyl-violet 6B. Paris violet. Dahlia. |
| Blues, - - - | { | Methylene blue. Victoria blue. Azur. Nile blue, or Capri's blue. Quinoline blue. Unna's polychrome blue. |
| Reds, - - - | { | Fuchsin. Rubin. Safranin. Neutral-red. |
| Greens, - - - | { | Methyl-green. Malachite green. |
| Bismarck brown, - | - | Vesuvium. |
| Colin black, - - - | - | Indulin. |

In the **acid dyes** on the other hand the staining agent is an acid combined with a coloured or colourless base. They are non-selective dyes and stain all tissues indifferently. Fluorescein (phthalic ether of resorcin), eosin (tetrabrom-fluorescein), aurantia, coccinine, acid fuchsin, tropæolin, magenta S, orange G, and picro-carmine are the acid dyes in most common use.

Note.—The aniline dyes have intense staining properties, and should be carefully handled; if the hands be stained accidentally they can be quite easily decolourized with soap. The powders should not be shaken.

Mordants.—In dyeing, an intermediary agent is used to fix the dye more firmly in the fabric. This intermediary agent is known as a mordant, and combining both with the dye and with the tissue unites the two intimately together.

Mordants are also used in staining micro-organisms, and though their mode of action is not as yet thoroughly understood, they undoubtedly increase the affinity of the dyes for the cells and render the staining more rapid and more lasting. The mordants in ordinary use are:

Acids.—Acetic acid.

Phenol.—Creosote.

Tannin.

Iodine in iodine-iodide solution.

Bromine in iodine-bromide and bromine-bromide solutions.

Perchloride of mercury.

Alkalis.—Caustic potash, ammonia, sodium borate, ammonium carbonate, and certain organic alkalis (aniline, phenylamine, toluidine).

Mixtures of two dyes, of which one acts as a mordant towards the other.

Action of heat.—The rapidity and depth of the staining can be increased by heating the preparation in a bath of the stain to 60° or 100° C.

1. Staining solutions.

The staining solutions used in bacteriology are very numerous. Every observer has his own preferences, so that there is a multiplicity of formulæ, making the subject very complicated and embarrassing for the beginner and practical work would gain much by a reduction and simplification of these staining processes. As a matter of fact a few formulæ will meet all ordinary requirements, and if these be thoroughly understood errors which often arise from the use of too complicated and unfamiliar methods will be avoided.

The various formulæ to be found in papers published during recent years must be given, but those methods which in our own experience have given good results will be distinctly indicated and will be found sufficient for practically all purposes. The acid dyes will not be dealt with in this chapter but will be referred to later, and the consideration of some of the staining methods of limited application will be deferred until occasion for their use arises.

To avoid mistakes only good dyes obtained from well-known sources should be used.

A. Simple solutions.

These solutions have only a limited use; staining solutions containing a mordant are generally better.

(i) Alcoholic solutions.

Alcoholic solutions of the basic aniline dyes are prepared by mixing in a ground-glass stoppered bottle:

| | |
|-----------------------------|---------|
| Dye, - - - - - | 1 gram. |
| Absolute alcohol, - - - - - | 10 c.c. |

Shake well and leave the alcohol standing on the dye. Filter before use. Alcoholic solutions keep for a very long time in the dark, and solutions of the following dyes should be kept in the laboratory, viz. **fuchsin**, **crystal-violet** or **gentian-violet**, and **methylene blue**.

These solutions are not used for staining, but when diluted with water serve for the preparation of watery alcoholic solutions.

(ii) Watery alcoholic solutions.

Watery alcoholic solutions are prepared by mixing

| | |
|---|-------------|
| Filtered alcoholic solution of the dye, - - - - - | 1 to 5 c.c. |
| Distilled water, - - - - - | 100 c.c. |

Filter immediately before use.

These solutions are seldom used in this form, as they do not keep well: it is simpler to make them up as required by pouring several cubic centimetres of water into a porcelain dish, and adding to it a few drops of the filtered alcoholic solution until an iridescent pellicle with a metallic lustre appears covering the surface.

(iii) Aqueous solutions.

Mix in a small bottle

| | |
|----------------------------|------------|
| Dye, - - - - - | 0.25 gram. |
| Distilled water, - - - - - | 25 c.c. |

Shake and leave the water standing on the dye. Filter before use.

The above proportions give a saturated solution and there should be an excess of the dye at the bottom of the bottle.

These solutions are very little used: they do not keep well and should be prepared as required. They stain slowly but sharply.

Aqueous solutions of **quinoline blue**, **vesuvin**, **methyl-green** and **neutral-red** are used for staining living organisms.

B. Staining solutions containing a mordant.

(i) Carbolic acid solutions.

These are more used than any other stains and retain their properties for a very long time.

Ziehl's carbol-fuchsin.

| | | | | | | | |
|-------------------------|---|---|---|---|---|---|----------|
| Basic fuchsin, | - | - | - | - | - | - | 1 gram. |
| Carbolic acid crystals, | - | - | - | - | - | - | 5 grams. |
| Absolute alcohol, | - | - | - | - | - | - | 10 c.c. |
| Distilled water, | - | - | - | - | - | - | 100 " |

Rub up the fuchsin and alcohol in a glass mortar, add the carbolic acid and mix; add two-thirds of the water little by little, stirring all the time; pour the mixture into a bottle then rinse out the mortar with the remainder of the water and add it to the mixture in the bottle. Leave for 24 hours before filtering into a clean ground-glass stoppered bottle.

A diluted solution prepared as follows is often used:

| | | | | | | | |
|-------------------------|-------------------------------|---|---|---|---|---|--------------|
| Mix | <i>Dilute carbol-fuchsin.</i> | | | | | | |
| Ziehl's carbol-fuchsin, | - | - | - | - | - | - | 1 c.c. |
| Distilled water, | - | - | - | - | - | - | 3 to 10 c.c. |

Mix and filter just before use.

Carbol-gentian-violet (Nicolle).

| | | | | | | | |
|-------------------------|---|---|---|---|---|---|----------|
| Gentian-violet, | - | - | - | - | - | - | 1 gram. |
| Carbolic acid crystals, | - | - | - | - | - | - | 2 grams. |
| Absolute alcohol, | - | - | - | - | - | - | 10 c.c. |
| Distilled water, | - | - | - | - | - | - | 100 " |

Prepare as in the case of carbol-fuchsin. Use as such. This solution is chiefly used for Gram's stain.

Carbol-crystal-violet (Roux).

Substitute crystal-violet for gentian-violet and prepare in the same way as the preceding solution.

Crystal-violet has the advantage over gentian-violet of being a well-defined crystalline compound. Gentian-violet is an amorphous product which varies in composition. Crystal-violet however is not so powerful a dye as gentian-violet.

Carbol-thionin (Nicolle).

| | | | | | | | |
|-------------------------|---|---|---|---|---|---|---------------|
| Thionin, | - | - | - | - | - | - | 0.5 to 1 gram |
| Carbolic acid crystals, | - | - | - | - | - | - | 1 gram |
| 90 per cent. alcohol, | - | - | - | - | - | - | 10 c.c. |
| Distilled water, | - | - | - | - | - | - | 100 " |

Prepare in the same way as carbol-fuchsin. This stain is recommended for sections and films; it stains rather more slowly but gives better results than crystal-violet and gentian-violet and does not overstain.

Carbol-methylene-blue (Kühne).

| | | | | | | | |
|-------------------------|---|---|---|---|---|---|-----------------|
| Methylene blue, | - | - | - | - | - | - | 1.5 to 2 grams. |
| Carbolic acid crystals, | - | - | - | - | - | - | 2 grams. |
| Absolute alcohol, | - | - | - | - | - | - | 10 c.c. |
| Distilled water, | - | - | - | - | - | - | 100 " |

Prepare in the same way as the foregoing solutions.

Unna's polychrome blue.

| | | | | | |
|--|---|---|---|------|-------------|
| Unna's polychrome blue solution (Grübler), | - | - | - | 100 | c.c. |
| Carbolic acid crystals, | - | - | - | 1 | gram. |
| 90 per cent. alcohol, | - | - | - | 10 | c.c. |
| Distilled water, | - | - | - | Q.S. | to 100 c.c. |

Dissolve the carbolic acid in the alcohol, add sufficient water to make up to 80 c.c. and then add the polychrome blue.

(ii) **Aniline solutions.**

These solutions keep badly and should be freshly prepared every time they are wanted. They have no advantage over carbolic solutions and are gradually dropping out of use.

In preparing them, the following solution must first be made up :

Aniline oil water.

| | | | | | | |
|------------------|---|---|---|---|-----|------|
| Aniline oil, | - | - | - | - | 5 | c.c. |
| Distilled water, | - | - | - | - | 100 | „ |

Mix the oil and water in a yellow glass bottle, shake vigorously and leave them in contact. Just before use filter the solution through a previously moistened filter paper. See that no fine droplets of oil pass through the filter as this would spoil the results of the staining; should this accident occur, filter the solution again.

Ehrlich's aniline-violet.

Filter into a porcelain dish about 10 c.c. of aniline oil water. To the filtrate add a few drops of a filtered alcoholic solution of gentian-violet until an iridescent pellicle appears. Use the solution at once. It should be freshly prepared every day.

Aniline-fuchsin, aniline-crystal-violet and aniline-methylene-blue are all prepared in the same way.

(iii) **Alkaline solutions.**

These solutions have been extensively used in Germany. Almost the only alkaline solution now used however is **Loeffler's alkaline methylene blue**. **Borrel's blue** (*vide Hæmatozoa*) is an alkaline dye. [Borax blue also is not infrequently used for staining some of the hæmatozoa (*q.v.*)]

Loeffler's alkaline methylene blue.

| | | | | | |
|---|---|---|---|-----|------|
| Alcoholic solution of methylene blue, | - | - | - | 30 | c.c. |
| 1 in 10,000 aqueous solution of caustic potash, | - | - | - | 100 | „ |

Mix in a bottle and filter before use. This solution is rapidly decomposed by the caustic potash combining with the CO₂ of the atmosphere.

Kühne's alkaline blue.

| | | | | | |
|---|---|---|---|-----|------|
| Alcoholic solution of methylene blue, | - | - | - | 30 | c.c. |
| 1 per cent. aqueous solution of ammonium carbonate, | - | - | - | 100 | „ |

Mix and filter before use. This solution keeps better than Loeffler's.

(iv) **Perchloride solutions.***Nastikow's violet.*

| | | | | | |
|---|---|---|---|----|------|
| 1 in 2000 aqueous solution of perchloride of mercury, | - | - | - | 10 | c.c. |
| Alcohol solution of gentian-violet, | - | - | - | 1 | „ |

Mix and filter. This stain does not keep well.

(v) **Complex stains.***Roux's blue.*

SOLUTION A.

| | | | | | | | |
|-------------------|---|---|---|---|---|---|---------------------|
| Violet dahlia, | - | - | - | - | - | - | 1 gram. |
| Absolute alcohol, | - | - | - | - | - | - | 10 grams. |
| Distilled water, | - | - | - | - | - | - | Q.S. for 100 grams. |

SOLUTION B.

| | | | | | | | |
|-------------------|---|---|---|---|---|---|---------------------|
| Methyl-green, | - | - | - | - | - | - | 2 grams. |
| Absolute alcohol, | - | - | - | - | - | - | 20 " |
| Distilled water, | - | - | - | - | - | - | Q.S. for 200 grams. |

1. Prepare each solution separately by rubbing up the dye with the alcohol in a mortar and add the water gradually. Let the mixture stand for 24 hours in a bottle.
2. Then mix the two solutions, filter and store in a well-stoppered bottle.

2. Simple staining.

For purposes of staining there should be at hand—

(a) Several small glass funnels and a number of pieces of filter paper folded to fit them. Staining solutions ought always to be filtered before being used and should be dropped from the filter straight on to the preparation.

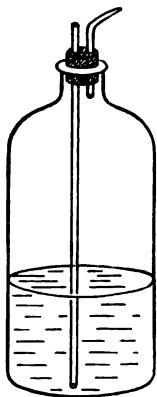

FIG. 126.—Wash-bottle.

(b) A wash-bottle filled with water recently filtered through a Chamberland filter (fig. 126). This bottle is so arranged that by simply tilting it the water runs out through the glass tube.

(c) In the absence of a sink, a large glass dish to collect the washings.

(d) A number of slides and cover-glasses, a pair of Cornet's or Debrand's forceps, platinum needles, a piece of soft cloth, some small squares of filter paper or a packet of cigarette papers and a few Pasteur pipettes.

(e) A Bunsen burner with a pilot flame.

(i) The methods of staining living organisms.

The object of staining living organisms is to make them more readily visible for microscopical examination while at the same time preserving their motility.

For this purpose aqueous solutions of dyes which have no toxic action on the organisms are used *e.g.* vesuvin (Metchnikoff), methyl-green (Babès), quinoline blue, fuchsin, neutral-red, etc.

Technique.—Make the preparation in the same way as for the examination of unstained living organisms. Invert the cover-glass on the slide and run a drop of a watery solution of the dye along the edge of the cover-glass; by capillary action it will be drawn between the cover-glass and slide.

Or if preferred a small drop of the stain can with a very fine pipette be added to the culture on the cover-glass and the two solutions mixed with the end of the pipette; the cover-glass is then inverted on the slide and the preparation is ready for examination.

(ii) The staining of dried films.

This is the best method of examining the morphology of micro-organisms and it gives moreover preparations which are practically permanent.

Technique.—**A. 1.** Pick up a cover-glass with a pair of Cornet's forceps,

place a drop of a broth culture about its centre and spread the drop with the end of a pipette; *or*

Place a small drop of filtered water on the cover-glass, mix a trace of the growth from a solid medium with it and spread the mixture with a platinum wire.

2. Dry the film gently either by holding it above the pilot flame of a Bunsen or by placing it on a Koch's drying stage (fig. 127) heated to 45° or 50° C.

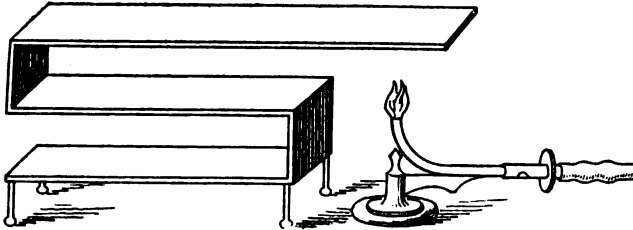

FIG. 127.—Koch's drying stage.

While the film is drying keep the liquid evenly spread over the cover-glass to prevent the formation of concentric circles.

3. Now *fix* the film to prevent the organisms being washed off by the stain, etc. This may be done either (a) by passing the cover-glass, film upwards, two or three times through the ordinary Bunsen flame; the organisms are liable to be distorted and shrivelled by this procedure so that it is better (b) to pour two or three drops of alcohol-ether on the film side of the cover-glass and let it evaporate. This method produces no distortion of the organisms.

Alcohol-ether.

| | |
|-----------------------------|---------|
| Absolute alcohol, - - - - - | 50 c.c. |
| Ether pur., - - - - - | 50 " |

In special cases it is better to fix the films by immersing them in absolute alcohol for 15 or 20 minutes or by exposing them to the vapour of osmic acid (*vide Treponema pallidum*).

4. Filter two or three drops of *stain* straight on to the film (diluted carbol-fuchsin, carbol-thionin, alkaline blue, etc., may any of them be used). Be careful not to let the stain run on to the under surface of the cover-glass. Stain for $\frac{1}{2}$ to 1 minute.

5. *Wash* off the stain by running a gentle stream of water from the wash-bottle on to a corner of the cover-glass. The water ought not to be poured on to the centre of the film for fear of washing it off.

6. The film may now be examined (with the $\frac{1}{2}$ in. immersion lens and a No. II. eyepiece, for preference):

(a) Provisionally, in water, by inverting the wet cover-glass on to a slide, blotting the upper surface of the cover-glass with a fine cloth [or filter paper] and then placing a drop of immersion oil on the blotted surface.

(b) After drying and mounting in Canada balsam. If the film is to be mounted, dry the cover-glass either in the air or by heating it gently, and place a small drop of balsam with the end of a fine glass rod on the film side, invert it on to a slide and press gently to spread the balsam.

To sum up: *Spread a drop of culture on a cover-glass, dry, fix, stain, wash in water, dry, mount in balsam and examine.*

Notes.—(a) It is important in staining films to remember which is the film side of the cover-glass. If this should be forgotten, gently scratch the surfaces of the

cover-glass near the edge with the point of a needle, and the side on which the film has been spread will be easily distinguished by the little scratches which will remain. But the possibility of losing the film side can be avoided by marking the upper limb of the forceps with a glass pencil, or by the use of a pair of Cornet's forceps on one limb of which a small knob-like depression is impressed in the metal; if the forceps be always used with this knob upwards it will act as a guide.

(b) A small quantity only of culture should be used for making the film. The shape of the organisms can best be made out when there are only a few in the field of the microscope.

(c) The Canada balsam should be dissolved with xylol and the solution should be of such a consistency that it does not tail when a drop is taken out with the glass rod. Balsam should be kept in a bottle stoppered with a glass bell-stopper and having a rim arranged so that the excess of balsam taken up on the glass rod can be drained off.

(d) Alcohol-ether, alcohol and volatile reagents generally are best kept in drop-bottles stoppered with ground-glass stoppers (several patterns can be obtained at the shops): shallow thick glass bottles of 60 to 100 c.c. capacity are perhaps the most convenient.

B. The method which has just been described is especially useful for delicate work and for making films which are to be preserved. But for the provisional examination of cultures and for routine work it is quicker and more economical to work with slides.

1. Take a slide between the fingers or hold it in a pair of Debrand's forceps, and place a little drop of the culture on it.

2. Spread, dry and fix as in the former case (A).

3. Stain the film and wash it in the manner described, and then dry the slide. Put a drop of cedar-wood oil straight on to the film without using a cover-glass and examine with the oil-immersion lens.

If after examination it is desired to preserve the preparation the cedar-wood oil can be washed off with a few drops of xylol, and when this has evaporated the slide is put away dry. Or after washing off the cedar oil the film may be mounted with a drop of balsam and cover-glass.

C. Another method which gives excellent results and is commonly adopted by us seems to deserve description here.

[1. The film is spread, dried and fixed on a slide as in B.

[2. Wash the film for a moment or two in a 10 per cent. aqueous solution of acetic acid. Wash thoroughly in water. Blot and dry.

[3. Place a drop of the stain on the centre of the film and lower a cover-glass on to the stain, avoiding the introduction of air bubbles. Blot the upper surface of the cover-glass with blotting paper.

[4. Put a drop of oil on the dried surface of the cover-glass and examine with a $\frac{1}{2}$ oil immersion.

[If the preparation is to be preserved, float off the cover-glass from the slide by putting a drop or two of water at the edge of the cover-glass. Wash the slide in water, blot and dry it. The slide may then be kept indefinitely.

[Both in this method and in the preceding, the film may be decolourized in a 10 per cent. aqueous solution of acetic acid or in alcohol, and then restained with another dye; so that using the same film one may first determine the morphology of the organism by examination in a simple stain and then ascertain its reaction to Gram's stain (*vide infra*).]

3. Gram's method of staining.

Gram devised a method of staining which serves to divide bacteria into two large groups.

Some bacteria, when stained with a basic pararosanilin dye in aniline or

carbolic solution and treated afterwards with a special mordant containing iodine, are not decolourized by absolute alcohol and similar decolourizing agents. The anthrax bacillus is an example of this group.

On the other hand, other bacteria when treated in the same way are readily decolourized with absolute alcohol, *e.g.* the typhoid bacillus.

Bacteria then are classified with reference to these reactions into two groups, termed **gram-positive** (organisms which retain the stain) and **gram-negative** (organisms which are decolourized). The anthrax bacillus is said to be gram-positive, and the typhoid bacillus gram-negative.

The mordant has the following composition :

Gram's (or Lugol's) solution.

| | |
|-----------------------------|----------|
| Iodine, | 1 gram. |
| Potassium iodide, | 2 grams. |
| Distilled water, | 300 c.c. |

In the original method absolute alcohol was used as the decolourizing agent. But pure aniline oil (Weigert) or acetone alcohol (Nicolle) are now sometimes used in its place.

Acetone alcohol.

| | |
|-----------------------------|----------|
| Absolute alcohol, | 5 parts. |
| Acetone, | 1 part. |

According to Nicolle, a bromine-bromide, iodine-bromide, or bromine-iodide solution may any of them be used in place of Gram's solution. They are all prepared in the same proportions as Gram's iodine-iodide solution.

Gram's stain has undergone many modifications, and is used as a double stain for films, sections, etc. These modifications will be dealt with in a special chapter and for the present the use of this classical method as a means of diagnosis will alone be considered.

Technique.—1. Prepare a film on a slide or cover-glass.

2. Stain for 30 to 60 seconds with carbol-gentian-violet.

3. Blot up the excess of stain (but do not wash), drop two or three large drops of Gram's solution on the film and let it act for 20 to 30 seconds. The preparation will have now assumed a brown tint.

4. Wash in water and dry.

5. Pour absolute alcohol over the film a drop at a time until no more violet stain comes away—usually 20 to 30 seconds (Notes (a) and (b) *infra*).

6. Wash in water quickly.

7. Examine the film in water. If the organisms are gram-positive they are stained deep violet, but if gram-negative decolourized: sometimes some of the organisms will be decolourized while others are still stained violet; in that case a further washing in alcohol will complete the reaction.

[Many bacteriologists prefer to counterstain the film. For this purpose, after washing in water (Stage 6) the film is flooded with some weak staining solution the colour of which is in sharp contrast with violet. Dilute carbol-fuchsin (1-5 or 1-10) or bismarck brown (p. 136) is convenient; the former is allowed to act for about $\frac{1}{2}$ minute, while bismarck brown requires rather longer (2 minutes). Wash in water, blot and dry. Gram-positive organisms are as in the former case stained violet, while gram-negative organisms being decolourized by the alcohol take the counterstain and appear pink or brown as the case may be.]

To keep the cover-glass preparation, dry and mount in balsam. If the film was made on a slide it merely requires to be dried.

To sum up: Prepare and fix a film, stain, treat with iodine solution, wash, dry, treat with alcohol, wash [counterstain, wash,] dry and examine.

Notes.—(a) Stage 5, decolourization, is a delicate manipulation. The length of time during which decolourization must be continued varies with the intensity of the stain used, the length of time during which it is allowed to act, the number of organisms, etc.; practice and a certain amount of skill are more than any rules the secrets of success. It is obvious that insufficient decolourization of a gram-negative organism may lead to mistakes; on the other hand the most resistant bacteria can be decolourized by prolonging unduly the action of the alcohol, and such treatment might result in a gram-positive organism being classed with the gram-negative group.

[(b) In view of the difficulty as to the time of decolourization we have found it useful, especially for beginners and in dealing with organisms such as the meningococcus, to prepare on the same slide three separate films. At one end there will be a film of a gram-positive organism e.g. *Staphylococcus*, at the other end a gram-negative organism e.g. *Bacillus coli communis*, and in the centre the organism whose reaction is to be tested e.g. *Meningococcus*. The films are stained and decolourized as described above, and then examined in water. If decolourization is sufficient, the staphylococci are all violet and the colon bacilli all pink (or brown). If the films have been under-decolourized some of the bacilli will be stained violet, and if over-decolourized some of the cocci will be pink (or brown). When it is evident that the decolourization has been correctly done the organism whose reaction is being tested is examined.]

(c) Films prepared by Gram's method do not keep so well as when stained with ordinary stains and ultimately become decolourized.

4. Claudius' method.

Claudius suggested a method of staining which, while having all the advantages, has both a simpler technique and gives more constant results than Gram's method. Thus the bacillus of malignant oedema and the bacillus of quarter ill are somewhat readily decolourized by Gram's method but retain the stain well by Claudius' method.

The author repeated Claudius' experiments and obtained results which fully confirm that observer's. Claudius' method has many advantages for the student; beginners using Gram's method never know when to stop decolourizing, sometimes they leave the alcohol on too long and sometimes they do not let it act for long enough, and in either case the results are unsatisfactory. These difficulties do not arise in Claudius' method.

The following solutions are required :

(a) A 1 per cent. aqueous solution of methyl violet 6B (or a solution of carbol-gentian violet).

(b) A solution of picric acid.

| | | | | | | | |
|------------------------------------|---|---|---|---|---|---|---------|
| Saturated solution of picric acid, | - | - | - | - | - | 1 | volume. |
| Distilled water, | - | - | - | - | - | 1 | " |

Technique.—1. Prepare and fix a film in the ordinary way.

2. Stain with violet for 1 minute.

3. Wash in water, and blot up the excess.

4. Treat with the picric acid solution for 1 minute and blot.

5. Decolourize with chloroform or clove oil until the decolourizing agent is no longer tinted blue.

6. Examine in clove oil or mount in balsam.

CHAPTER IX.

THE STAINING OF SPORES, CAPSULES AND FLAGELLA. THE STUDY OF THE MOTILITY OF BACTERIA.

Section I.—Spores, p. 145.

1. The examination of unstained preparations, p. 145.
2. The staining of spores, p. 146.

Section II.—The staining of capsules, p. 147.

Section III.—The staining of flagella, p. 148.

1. The staining of flagella in living organisms, p. 148.
2. The staining of flagella in dried preparations, p. 149.

Section IV.—The methods of studying the motility of micro-organisms, p. 154.

SECTION I.—SPORES.

WITHIN the protoplasm of certain micro-organisms, a small bright refractile spot is seen at one period or another of their existence. This refractile body, which does not stain readily with the ordinary aniline dyes, is known as a **spore**, or more strictly an **endospore**. The occurrence of spores was first described by Pasteur.

On the death or destruction of a spore-bearing organism the spores are set free from the protoplasm in which they originated. They are surrounded by a highly resistant membrane, which not only renders them immune to the agents ordinarily destructive of bacteria, but also prevents them becoming stained by the methods generally employed for staining micro-organisms.

Endospore formation does not occur in all bacteria : it is unknown in the micrococci, in which the resistant form is due to a thickening of the enveloping membrane and is known as an *arthrospore*. **Arthrospores** differ from endospores in that they react to stains in the same way as do their corresponding organisms.

It is therefore only necessary to describe the methods of staining endospores. The organisms more commonly used for illustrating the methods are the *Bacillus anthracis*, *Bacillus megatherium*, *Bacillus maligni œdematis*, *Bacillus tetani*, and *Bacillus subtilis*.

1. Examination of unstained preparations.

In unstained preparations the spore appears as a small, refractile, spherical or oval spot within the protoplasm of the cell ; it is surrounded by a bright refractile ring, and is always smaller than the mother cell. The mother cell gives rise to a single spore which becomes free on the disappearance of the cellular protoplasm ; the spore in turn germinates, giving origin to a new bacterium.

All these facts can be observed under the microscope in a hanging drop culture of the anthrax bacillus (p. 134). When it is desired merely to determine the presence of spores in bacteria an ordinary film is made on a slide as described on pp. 140 and 141.

2. The staining of spores.

When spore-bearing organisms are stained with the basic aniline dyes the spores do not take up the dye and appear as unstained spots in the stained bacilli. To stain the spore it is necessary therefore to apply special methods which have been designed to overcome its resistance to staining reagents.

(i) Simple staining.

This method stains both the bacilli and the spores.

A. Method recommended.—1. Prepare a cover-glass film of the culture to be examined and dry it.

2. Pass the cover-glass, film side uppermost, ten times through the heating flame of the Bunsen, but sufficiently quickly to prevent the preparation being scorched.

3. Stain with carbol-violet for 15 to 30 minutes.

4. Wash, dry, mount in balsam. Examine. The bacteria and the spores are both stained violet.

B. Chromic acid method.—1. Make a film on a cover-glass and dry it.

2. Drop a large drop of a 1 in 20 aqueous solution of chromic acid on the film, and leave it for 4 or 5 minutes.

3. Wash in water.

4. Stain in carbol-violet for 15 minutes to half an hour.

5. Wash. Mount. Examine.

(ii) Double staining.

The object of double staining is to differentiate the spore from the bacillus by staining the bacillus one colour and the spore a different colour.

Principle of the method.—Spores stain with difficulty, but once stained they retain the dye with more tenacity than the bacillary protoplasm, so that decolourizing agents will decolourize the latter before they take the stain out of the spores.

A. Method recommended.—1. Prepare a cover-glass film, dry and fix it by passing it rapidly through the flame two or three times.

2. Drop a large drop of carbol-fuchsin on the film and warm it over a small flame until steam just begins to rise, then keep the solution warm for 4 or 5 minutes by moving it about over the flame.¹ Both the bacilli and the spores are now stained an intense red.

3. Wash in water.

4. Decolourize for a few seconds in a solution of nitric acid :

| | | | | | | | | | |
|-------------------|---|---|---|---|---|---|---|---|----------|
| Pure nitric acid, | - | - | - | - | - | - | - | - | 1 part. |
| Distilled water, | - | - | - | - | - | - | - | - | 3 parts. |

The bacilli should be decolourized while the spores are still stained red.

5. Wash well in water.

6. Counterstain with a drop of diluted alcoholic solution of methylene blue for 30 to 60 seconds. The decolourized bacilli take up the blue stain.

7. Wash. Dry. Mount in balsam.

The bacilli are stained blue ; the spores red.

[¹ This may be done on a warm stage (p. 141, fig. 127) taking care to select a place where the metal is not too hot.]

Note.—This method gives excellent results with *B. megatherium* but is not so good for *B. anthracis*: absolute alcohol is a better decolourizing agent for the latter. Decolourization is in fact the difficult part of double staining, but after a few trials the extent to which decolourization must be pushed to decolourize the bacilli while leaving the spores stained can be determined for different organisms.

B. Møller's method.—1. Make a cover-glass film. Dry. Fix in absolute alcohol for 2 minutes, then in chloroform for 2 minutes. Dry.

2. Drop a few drops of a 1 in 20 aqueous solution of chromic acid on the film and leave for 4 or 5 minutes. Wash in water.

3. Stain in carbol-fuchsin in the warm as described above (A). Wash in water.

4. Decolourize for a few seconds in a 5 per cent. solution of sulphuric acid and complete the decolourization in absolute alcohol.

5, 6, 7. Wash. Stain in blue. Mount.

C. Aladar-Aujesky's method.—1. Make a cover-glass film. Dry in the air.

2. Dip the preparation for 2 to 4 minutes into a porcelain capsule containing a 0.5 per cent. solution of pure hydrochloric acid which has been heated but not boiled.

3. Wash freely in water. Dry. Fix in the flame.

4. Stain with carbol-fuchsin in the warm by heating until steam rises: as the stain evaporates add a fresh supply.

5. Decolourize rapidly in a 4 per cent. solution of sulphuric acid.

6. Wash. Stain in blue. Mount.

D. Orszag's method.—1. Place a small drop of the following mixture on a cover-glass.

0.5 per cent. aqueous solution of sodium salicylate, - - 4 parts.

5 per cent. aqueous solution of acetic acid, - - - 1 part.

Make an emulsion of the organisms in this solution. Dry. Fix the film in the flame.

2. Stain with carbol-fuchsin in the warm for 2 minutes.

3. Decolourize with a 1 per cent. aqueous solution of sulphuric acid.

4. Wash. Counterstain with blue. Mount as before.

E. Thesing's method.—1. Prepare a cover-glass film. Dry. Fix in the flame.

2. Place a drop of a 1 per cent. aqueous solution of platinum chloride on the film. Heat to boiling.

3. Wash in a large quantity of water. Dry.

4. Stain with carbol-fuchsin as in the foregoing methods.

5. Decolourize with 33 per cent. alcohol.

6. Wash. Dry. Counterstain with blue. Mount.

SECTION II.—THE STAINING OF CAPSULES.

Some micro-organisms are surrounded by a bright hyaline area called a capsule which can be demonstrated by certain staining devices. When these are employed the organism is deeply stained, while the capsule surrounding it is pale with a feebly stained margin.

A. 1. Having dried and fixed a film, stain for 1 minute in carbol-fuchsin.

2. Wash. Treat for 20–30 seconds with water containing 1 per cent. acetic acid.

3. Wash. Dry. Mount in balsam.

In the author's hands this method has given better results than the following.

The method may be modified by treating the film first with a 1 per cent. solution of acetic acid for 1 minute, then drying it and afterwards staining with carbol-violet.

Simple staining with dilute carbol-fuchsin also gives quite good results.

B. 1. Dry and fix a film on a cover-glass.

2. Stain with a drop of the following solution for 30–60 seconds :

Acetic violet.

| | |
|--|------------|
| Acetic acid, - - - - - | 1 gram. |
| Alcoholic solution of gentian-violet, or crystal-violet, - - | 5 c.c. |
| Distilled water, - - - - - | 100 grams. |

3. Wash. Dry. Mount in balsam.

C. Ræbiger suggests staining the dried but unfixed films in the following solution, which must be filtered :

| | |
|--------------------------------|-----------|
| Gentian-violet, - - - - - | 15 grams. |
| Commercial formalin, - - - - - | 100 „ |

After staining, wash, dry and mount in balsam. The bacteria are stained violet and the capsules violet with a pink tint.

D. Nicolle recommends staining with carbol-gentian-violet followed by rapid decolourization in a 1 in 3 solution of acetone-alcohol. Mount and examine in water.

Hiss fixes the films in the flame, stains in a 5 per cent. aqueous solution of gentian-violet or fuchsin in the warm, then washes in a 20 per cent. solution of copper sulphate, dries and mounts in balsam.

He also recommends staining in a half-saturated aqueous solution of gentian-violet followed by washing in a 0.25 per cent. aqueous solution of potassium carbonate. The films should be examined in a drop of the potassium carbonate solution.

The staining of capsules in sections requires special methods which will be studied later (*vide Pneumococcus*).

SECTION III.—THE STAINING OF FLAGELLA.

Flagella are the organs of locomotion of the motile bacteria and are only visible in the living unstained condition in such large organisms as the sulpho-bacteria (*Bacterium photometricum*, *Beggiatoa roseopersinica*, etc.). To demonstrate flagella in other motile organisms complicated staining methods have to be adopted.

1. The staining of flagella in living organisms.**Straus' method.**

1. Place a drop of a broth culture of the organism on a slide.
2. Add a drop of carbol-fuchsin diluted with three or four parts of water and mix the culture with the stain.
3. Cover with a cover-glass and examine at once with an oil-immersion lens.

The bacilli are stained an intense red and the flagella, which will be seen especially well on the living actively-motile bacilli, assume a pale pink colour with deeper red points scattered along their length.

Note.—This is a very rapid method but it only succeeds with certain organisms,

and its action on these is uncertain. The best results are obtained with *Vibrio cholerae asiatica*, *V. finkler-prior*, *V. metchnikowi*. The method fails altogether to stain the flagella of many organisms such as *B. febris enterica*, *B. coli communis*, *B. subtilis*, etc.

2. The staining of flagella in dried preparations.

General rules.

1. Take a small quantity of a young agar culture and make a perfectly homogeneous, very faintly opalescent emulsion in a watch-glass containing ordinary water, or preferably distilled water.

2. Fix an absolutely clean cover-glass in a pair of Cornet's forceps, pass it through the flame, and when cool place a drop of the emulsion on it with a pipette. Unless the cover-glass be perfectly clean the liquid will not spread uniformly.

3. By tilting the cover-glass run the liquid over the surface, then let the excess gravitate to one corner and aspirate it with a pipette.

4. Dry the film in the air away from dust and, without fixing, stain by one of the methods described below.

By following the above instructions, a dilution is obtained such that each field of the microscope contains only a few organisms, which is an essential condition for good results. By this method, also, the mucoid substances which agglomerate organisms in cultures and form precipitates on the cover-glass (thus obscuring the details) are as far as possible excluded.

(i) Van Ermengem's method.

(Method recommended.)

This method is based on the reduction of nitrate of silver in the flagella and gives very beautiful preparations. It is generally used in preference to any other method. [*Vide* also method (xi) p. 153.]

1. Place the film for 1 minute at 50° C. (or 30 minutes at room temperature) in the following bath which must be freshly prepared :

| | | | | | |
|---|---|---|---|---|---------|
| 2 per cent. aqueous solution of osmic acid, | - | - | - | - | 8 c.c. |
| 10 per cent. aqueous solution of tannin, | - | - | - | - | 16 " |
| Glacial acetic acid, | - | - | - | - | 1 drop. |

2. Wash in water, then in absolute alcohol.

3. Treat the film with silver for 1 or 2 minutes.

| | | | | | | |
|-----------------------------|---|---|---|---|---|----------|
| Crystals of silver nitrate, | - | - | - | - | - | 1 gram. |
| Distilled water, | - | - | - | - | - | 200 c.c. |

4. Without washing, transfer the film for 1 minute to the reducing solution.

| | | | | | | |
|-----------------------|---|---|---|---|---|----------|
| Gallic acid, | - | - | - | - | - | 5 grams. |
| Tannin, | - | - | - | - | - | 3 " |
| Fused sodium acetate, | - | - | - | - | - | 10 " |
| Distilled water, | - | - | - | - | - | 350 c.c. |

5. Without washing, put the preparation into the silver bath again and keep the liquid moving over the film until the latter assumes a black tint.

6. Wash. Dry. Mount in balsam.

(ii) Loeffler's method.

The method devised by Loeffler, for a long time the classical method of staining flagella, requires a good deal of practice and gives only mediocre results. The films are often covered with an abundant precipitate which obscures the flagella and renders their detection difficult.

The following reagents are required :

| | |
|--|---------------|
| <i>Fuchsin ink.</i> | |
| 25 per cent. aqueous solution of tannin, - - - - | 10 c.c. |
| Cold saturated solution of ferrous sulphate, - - - - | 5 " |
| Saturated alcoholic solution of fuchsin, - - - - | 1 " |
| <i>Alkaline solution.</i> | |
| Alcoholic soda, - - - - - | 1 gram. |
| Distilled water, - - - - - | 100 c.c. |
| <i>Acid solution.</i> | |
| Pure sulphuric acid, - - - - - | 1 gram. |
| Distilled water, - - - - - | 100 c.c. |
| <i>Staining solution.</i> | |
| Aniline water, - - - - - | 100 c.c. |
| 1 per cent. solution of soda, - - - - - | 1 " |
| Gentian-violet or fuchsin, - - - - - | 4 to 5 grams. |

Shake. Leave for a few hours in a bottle. Filter.

Technique.—1. **Mordanting.** Drop on to a film prepared as above (see general rules) a large drop of the fuchsin ink containing a few drops of the acid or alkaline solution. The amount of the latter depends upon the species of organism under examination. Heat the film over the pilot flame of a Bunsen until steam just begins to rise and continue the heating for 30–50 seconds: be careful not to boil the liquid. This stage of the method is very tricky and is liable to failure.

The amount of the acid or alkaline solution to be added to 16 c.c. of fuchsin ink has been determined by experiment. The following table shows the amounts necessary for the principal ciliated bacteria.

| | |
|---|-------------------------|
| Mordant alone without acid or alkali, - - - - | Spirillum concentricum. |
| Mordant + $\frac{1}{2}$ -1 drop of acid solution, - - - - | V. cholerae asiaticæ. |
| " + 6 drops " " " - - - - | B. pyocyaneus. |
| " + 18-20 " " " - - - - | Micrococcus agilis. |
| " + 20 " " " - - - - | B. chauvæi. |
| " + 20-30 drops of alkaline solution, - - - - | B. febris entericæ. |
| " + 28-30 " " " - - - - | B. subtilis. |
| " + 26-28 " " " - - - - | B. maligni œdematis. |
| " + { from 20 drops of acid solution to 15 drops of alkaline solution, } - - - - | Bacillus of blue milk. |

2. **Washing.**—Wash in water, then in absolute alcohol.

3. **Staining.**—Place a drop of the staining solution on the film, heat until steam begins to rise gently, and let the hot stain act for about a minute.

4. **Mounting.**—Wash in a large volume of water and examine in water. If satisfactory, dry and mount in balsam.

(iii) Remy and Sugg's method.

This method, which is a modification of Loeffler's, is designed to avoid the formation of granular precipitates. The fuchsin solution is used cold, and after staining the film is treated with iodine.

Instead of Loeffler's the following stain is used :

| | |
|---|---------|
| <i>Staining solution.</i> | |
| Phenylamine water, ¹ - - - - - | 20 c.c. |
| Alcoholic solution of gentian-violet, - - - - - | 1 drop. |
| Distilled water, - - - - - | 5 c.c. |

Mix the gentian-violet with the water and then add the phenylamine water.

Technique.—1. The mordanting process is the same as in Loeffler's method but the solution is left on the film for 15–30 minutes and is not heated.

2. Pour off the mordant and replace it at once with a drop of Gram's solution.

3. Wash in water, then in absolute alcohol.

4. Place the film in a watch-glass filled with the stain and leave it for half an hour, preferably in the warm (37° C.) incubator.

5. Wash in water. Examine in water. Dry. Mount in balsam.

¹ Prepare in a similar manner to aniline oil water (p. 139).

(iv) **Nicolle's and Morax's method.**

(Method recommended.)

This method, a simplification of Loeffler's, does away with the use of the acid and alkaline solutions and is a satisfactory stain for the flagella of all motile organisms. Carbol-fuchsin is used instead of Loeffler's stain.

1. **Mordanting.**—Place a large drop of fuchsin ink (without any addition of acid or alkali) on the film. Heat for 10 seconds over the pilot flame of a Bunsen.

When steam begins to rise, pour off the solution, tilt the cover-glass and run a gentle stream of water from a wash-bottle on to its upper angle so as to wash the film well without washing the organisms away.

Repeat the mordanting and washing two or three times. Wipe the under surface of the cover-glass and the teeth of the forceps each time after washing: otherwise when the mordant is poured on again the solution will run under the cover-glass and along the forceps.

2. **Staining.**—Put a drop of carbol-fuchsin on the film and heat once or twice until steam has been rising for 15 seconds.

3. **Mounting.**—Wash and examine in water. If the preparation be satisfactory, dry and mount in balsam.

Bunge's and de Rossi's methods.—These methods differ slightly from that of Nicolle and Morax but have no advantage over the latter.

Bunge's mordant.

| | |
|--|----------|
| Saturated aqueous solution of tannin, - - - | 3 parts. |
| 1 in 20 aqueous solution of perchloride of iron, - - - | 1 part. |

To ten parts of this mixture add one part of a saturated aqueous solution of fuchsin. The mordant must be exposed to the air for a few weeks before use; while so exposed it acquires a brownish-red colour.

Filter a few drops of the above solution on to the film and leave it for 5 minutes: wash in water and dry: stain with carbol-fuchsin as in Nicolle and Morax's method: wash, dry and mount in balsam.

De Rossi treats the film for 10 minutes with the following solution:

| | |
|---|----------|
| Tannin, - - - - - | 5 grams. |
| 0.1 per cent. aqueous solution of potash, - - - | 100 c.c. |

Wash in water. Dry. Stain with carbol-fuchsin as in Nicolle's and Morax's method. Wash. Dry. Mount.

(v) **Trenkmann's method.**

This method gives satisfactory results but it takes too long to be of use in routine work.

1. Leave the film in the following solution for 6–8 hours:

| | |
|-----------------------------------|----------|
| Tannin, - - - - - | 2 grams. |
| Distilled water, - - - - - | 100 c.c. |
| Pure hydrochloric acid, - - - - - | 4 drops. |

2. Wash in water. Treat the film for 1 hour in a watch-glass containing a saturated solution of metallic iodine in distilled water.

3. Wash in water. Stain in aniline-gentian-violet for half an hour.

4. Wash in water. Examine. Dry. Mount in balsam.

(vi) **Cerrito's method.**

This method requires a good deal of care, because the mordant frequently gives rise to troublesome deposits.

The mordant consists of the following somewhat complex mixture:

| | |
|--|---------|
| 25 per cent. aqueous solution of tannin in ether, - - - | 20 c.c. |
| 5 per cent. aqueous solution of pure iron-alum, - - - | 10 " |
| Saturated solution of fuchsin in 90 per cent. alcohol, - - - | 1 " |

Pour these solutions into a well plugged flask : heat the mixture to 100° C. in a water bath, thoroughly mixing the ingredients by shaking and continue to heat until the liquid is pale in colour. The solution must be kept in an hermetically sealed bottle.

1. **Mordanting.**—Flood the cover-glass with a few drops of the mordant for 2 or 3 minutes at 25° C. or 10 minutes at 15° C. Wash in water. Dry.

2. **Staining.**—Stain in the following solution for a few seconds, heating the solution until steam just begins to rise :

| | | | | | | | | |
|-------------------------|---|---|---|---|---|---|---|------------|
| Fuchsin, | - | - | - | - | - | - | - | 0.25 gram. |
| Absolute alcohol, | - | - | - | - | - | - | - | 10 c.c. |
| Carbolic acid crystals, | - | - | - | - | - | - | - | 5 grams. |
| Distilled water, | - | - | - | - | - | - | - | 100 c.c. |

3. **Mounting.**—Wash in water. Dry. Mount in balsam.

(vii) **Pitfield's method. Benignetti and Gino's method.**

In Pitfield's method the mordant and the stain are combined in one solution, thus :

| | | | | | |
|---|---|---|---|---|---------|
| Saturated aqueous solution of alum, | - | - | - | - | 10 c.c. |
| 10 per cent. solution of tannin in water, | - | - | - | - | 10 " |
| Saturated alcoholic solution of gentian-violet, | - | - | - | - | 2 " |

Benignetti and Gino obtain very satisfactory results with the following very simple method which is a modification of the above.

The combined mordanting and staining solution is prepared thus :

| | | | | | | |
|---|---|---|---|---|---|-----------|
| A. Zinc sulphate, | - | - | - | - | - | 1 gram. |
| Tannin, | - | - | - | - | - | 10 grams. |
| Distilled water, | - | - | - | - | - | 100 " |
| B. Solution A, | - | - | - | - | - | 5 c.c. |
| Saturated aqueous solution of alum, | - | - | - | - | - | 5 " |
| Saturated alcoholic solution of gentian-violet, | - | - | - | - | - | 3 " |

Technique.—Fix the film with heat, and when cool flood it with a large drop of solution B, and heat it over the pilot light of a Bunsen until steam just begins to rise. Wash in water. Dry. Mount in balsam.

[**R. Muir's modification of Pitfield's method.**

[Prepare :

| | | | | | |
|---|---|---|---|---|---------|
| A. Filtered 10 per cent. aqueous solution of tannin, | - | - | - | - | 10 c.c. |
| Saturated aqueous solution of perchloride of mercury, | - | - | - | - | 5 " |
| Saturated aqueous solution of alum, | - | - | - | - | 5 " |
| Carbol-fuchsin, | - | - | - | - | 5 " |

[Mix thoroughly. Allow the precipitate to settle. Decant off the clear supernatant fluid. The mordant will keep for about a fortnight.

| | | | | | |
|---|---|---|---|---|---------|
| B. Saturated aqueous solution of alum, | - | - | - | - | 10 c.c. |
| Saturated alcoholic solution of gentian-violet, | - | - | - | - | 2 " |

The stain does not keep.

- [1. Prepare and fix a film as above (p. 149).
- [2. Flood the preparation with the mordant and heat until steam just begins to rise. Let the solution act for 1 minute.
- [3. Wash thoroughly in running water. Blot and dry over the flame.
- [4. Flood the film with the stain, heat as before for 1 minute.
- [5. Wash well in water.
- [6. Blot. Dry. Mount in balsam.]

(viii) **Bowhill's method.**

This method is troublesome and offers no special advantages.

1. **Mordanting.**—Place the film for 10 minutes at a temperature of 40°–50° C. in a

bath consisting of equal parts of the following solutions mixed just before use and filtered :

| SOLUTION A. | |
|-----------------------------|---------|
| Orcëin, - - - - - | 1 gram. |
| Absolute alcohol, - - - - - | 50 c.c. |
| Distilled water, - - - - - | 40 „ |

| SOLUTION B. | |
|----------------------------|----------|
| Tannin, - - - - - | 8 grams. |
| Distilled water, - - - - - | 40 c.c. |

Use heat to dissolve the tannin.

In staining the flagella of the *Vibrio cholerae asiaticæ* add 1 c.c. of a saturated solution of alum for each 10 c.c. of mordant.

2. **Washing.**—Wash in water. Dry.
3. **Staining.**—Flood the film with aniline-gentian-violet and heat until steam just rises from the film for 15–30 seconds.
4. **Mounting.**—Wash. Dry. Mount in balsam.

(ix) Gemelli's method.

1. Immerse the films in the following solution for 10–20 minutes.

| | |
|-----------------------------------|------------|
| Potassium permanganate, - - - - - | 0.25 gram. |
| Distilled water, - - - - - | 100 c.c. |
2. Wash in distilled water.
3. Stain for 15–30 minutes in the following mixture :

| | |
|--|---------|
| 0.75 per cent. aqueous solution of calcium chloride, - - - | 20 c.c. |
| 1 per cent. aqueous solution of neutral-red, - - - | 1 „ |
4. Wash in water. Dry in the air. Mount in balsam.

(x) Scavo's method.

Scavo's method fails to stain the flagella of some micro-organisms especially the flagella of the cholera vibrio. The author's experience has been that it is equally unsuited for the flagella of the colon bacillus.

1. Flood the film with a large drop of the mordant, viz. :

| | |
|---------------------------------|----------|
| 50 per cent. alcohol, - - - - - | 100 c.c. |
| Tannin, - - - - - | 1 gram. |
- Leave for 1 minute and then wash in water.
2. Treat for 1 minute with the following solution on the film :

| | |
|----------------------------------|----------|
| Phospho-tungstic acid, - - - - - | 5 grams. |
| Water, - - - - - | 100 c.c. |
 3. Wash quickly in water.
 4. Stain for 3 or 5 minutes with a drop of aniline-gentian-violet heating the stain until steam rises gently from the film.
 5. Wash and examine in water. Dry. Mount in balsam.

[(xi) Stephens' method.]

(Method recommended.)

[The method worked out by J. W. W. Stephens is a modification of van Ermengem's (p. 149) and depends upon the use of very strong ammonia as the reducing agent. With ordinary care a satisfactory result can be absolutely relied upon.

[To clean the slides.—Rub the slides with a clean cloth, place them on a piece of clean wire gauze and heat with a smokeless flame for some minutes (by this means grease is completely removed). Leave the slides until cool.

[To prepare the film.—Rub a little of the culture in a small drop of tap-water in a watch-glass. Transfer a drop with a very small platinum loop to a minute drop of water on the slide. Mix. Spread with the loop as quickly as possible. The film should dry immediately if only a small drop of water has been used. A

twenty-four hour growth on agar does quite well (a younger one is perhaps better, but flagella can be shown for a week or fortnight or more).

[The following solutions are required :

| | | | |
|--|---|---|---------------|
| (a) <i>The mordant.</i> | | | |
| 2 per cent. aqueous solution of osmic acid, | - | - | 1 part. |
| 20 per cent. aqueous solution of tannin, | - | - | 3 or 4 parts. |
| (b) <i>Silver nitrate solution.</i> | | | |
| Crystals of silver nitrate, | - | - | 1 gram. |
| Distilled water, | - | - | 100 c.c. |
| (c) <i>Reducing solution.</i> | | | |
| 2 per cent. aqueous solution of gallic acid, | - | - | 1 part. |
| Ammonia fort., ¹ | - | - | 1 .. |

Mix immediately before use.

[1. Place the mordant on the film for one or two minutes or less (time unimportant).

[2. Wash in tap-water thoroughly. Shake off as much water as possible.

[3. Place a few drops of the silver nitrate solution on the film for a few seconds or longer.

[4. Shake off the excess of silver solution.

[5. Allow one drop of the reducing solution to fall on the *middle* of the film from a pipette. A wave spreads away from the centre to each end of the slide. As soon as the film is seen standing out clearly and black (a few seconds), wash off in tap-water.

[6. Pour another drop or two of the silver solution on to the film and leave for half a minute or so.

[7. Wash in tap-water. Blot. Dry over a flame. The preparations fade rapidly if mounted in balsam or cedar-wood oil.]

SECTION IV.—METHODS OF STUDYING THE MOTILITY OF MICRO-ORGANISMS.

Closely connected with the morphological study of the flagella of micro-organisms is the investigation of their motility.² Motile organisms can make their way through porous substances such as sand or a filter composed of porcelain or siliceous earth. The time occupied in traversing a given thickness of sand, etc., will vary according as to whether the organism is actively or feebly motile.

These observations are utilized for determining whether or no an organism is motile, for separating motile from non-motile species, for determining the relative motility of different strains of the same organism, and even for creating, by a process of selection, races which are endowed with exceptional powers of movement.

A.—Cambier has drawn attention to the property possessed by the typhoid bacillus of traversing the walls of porous structures, and has suggested that this property might be made use of in attempting the isolation of the organism.

A porous porcelain bougie is placed in a large test-tube, and both the bougie and the test-tube are half-filled with broth; the tube is plugged with wool and the whole apparatus autoclaved. When cool, the broth in the bougie is sown with a culture of the typhoid bacillus. After incubating for a few hours at 37° C. the broth in the tube surrounding the bougie will be distinctly cloudy, and this is due to the fact that the typhoid bacillus

¹ [It is essential that the solution of ammonia be the strongest obtainable.]

² *Vide* also Chap. VII., Dark-ground illumination.

has passed through the porous walls of the bougie. Only motile organisms can do this, and of these the typhoid bacillus is one of the first to pass through. In attempting the isolation of the typhoid bacillus from water, the broth in the bougie would be sown with some of the suspected water, and when the broth surrounding it became cloudy a small quantity would be removed for the purposes of further investigation by the usual methods (Chap. XXIII.).

B.—Carnot and Garnier conceived the idea of making motile organisms pass by their own efforts through a layer of sand of known thickness, and then collecting the first organisms to pass through; they were thus able to determine exactly the time required by a given organism to make its way through a given thickness of sand. The degree of motility possessed by any species of micro-organism can by these means be exactly measured.

Technique.—1. A piece of glass tubing, 7 mm. calibre, is drawn out in the flame about its middle, and bent into an U-shape with the two limbs parallel and closely applied to each other, each being about 25 cm. long (fig. 128).

2. A loosely-packed plug of glass wool C is pushed down the limb A as far as the constriction in the lower part. Broth is then poured in to a depth of about 10 cm. in each tube. Very fine quartz sand (previously washed in hydrochloric acid for 48 hours, and then in water for several days and afterwards calcined in the hot air sterilizer) is slowly dropped down the tube A until it forms a column 10–15 cm. high. A and B are then plugged with wool, and the tube autoclaved.

3. The organism whose motility is to be investigated is then sown in the broth contained in the limb B in which there is no sand, and the tube incubated at 37° C. The passage of organisms through the sand is made manifest by a cloudiness of the broth in A. Only motile organisms reach the broth in A, and the time occupied varies with different species.

Carnot and Garnier give the following times for the most motile organisms :

| | | |
|--|-----------------------------|------------------------------------|
| <i>Vibrio cholerae</i> (Massaouah) | traverses 1 c.c. of sand in | 1 hr. 38 m. |
| " " (Dantzig) | " " " | 2 hrs. 4 m. |
| " " (Paris, 1884) | " " " | 4 hrs. |
| <i>Bacillus psittacosis</i> | " " " | 2 hrs. |
| <i>Bacillus febris entericae</i> | " " " | 3–6 hrs. |
| <i>Bacillus coli communis</i> | " " " | (variable, 1 hr. to several days). |
| Streptococci with feeble undulatory movements, | | 4 hrs. 50 m. |

Bacillus anthracis, *Staphylococcus pyogenes*, *Pneumococcus*, etc., do not pass through the sand.

This method like that of Cambier may be utilized for the isolation of motile organisms; moreover it renders possible, by successive passages of selected organisms, the creation of strains of a given bacillus possessed of exceptional motility. In this way Carnot and Garnier were able after five passages to isolate from a culture of the typhoid bacillus, which originally took 6 hours to traverse a centimetre of sand, a strain which passed through the same thickness in 1 hour and 4 minutes.

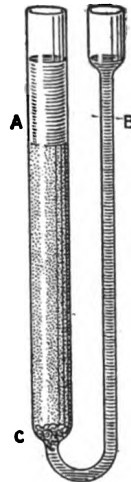

FIG. 128.—Carnot and Garnier's tube.

CHAPTER X.

ANIMAL INOCULATION.

Section I.—The selection of animals for inoculation, p. 156.

Section II.—The keeping of animals, p. 157.

Section III.—The spontaneous diseases of experimental animals, p. 159.

Section IV.—The handling of experimental animals, p. 160.

Section V.—Experimental inoculations, p. 165.

1. Instruments, p. 165. 2. Preparation of the material for inoculation, p. 169.

3. Technique of inoculation, p. 170.

Section VI.—Observations to be made on inoculated animals, p. 182.

SECTION I.—THE SELECTION OF ANIMALS FOR INOCULATION.

FOR purposes of experimental inoculation, animals are chosen preferably from among the mammalia, less frequently from among the other vertebrata. In deciding upon what species of animal shall be used for a given experiment there are of course various considerations which must be taken into account.

1. Susceptibility.—In the first place it is obviously necessary to select a species of animal suitable for the experiment in view. To produce a given disease experimentally, an animal susceptible to the virus should, generally speaking, be chosen, though it is sometimes desirable to use an animal immune to the particular disease and to destroy its immunity in some way or another. Some knowledge, therefore, of the diseases to which animals available for experimental purposes are susceptible is more or less indispensable. In subsequent chapters those animals which are susceptible to the action of the principal micro-organisms will be mentioned. When a new organism is under investigation and its pathogenic properties have to be determined it is desirable to inoculate as many different species of animals as possible.

2. Economic considerations.—In the majority of cases small animals are used; they are cheap to buy, and can be kept and fed at small expense, and, if need be, can be bred in the laboratory.

3. General considerations.—Whenever possible animals of quiet habits are chosen because they are easy to handle, and do not require elaborate cages.

Small rodents, such as rabbits, guinea-pigs, white mice, white rats, common brown mice [*Mus musculus*], and house rats [*Mus decumanus*] are, on the whole, more often used than any other animals for experimental inoculation; they are easily obtained, and the first four—to which the term “laboratory animals” generally refers—are susceptible to most of the organisms pathogenic to man.

Cattle, goats, pigs, horses, sheep, asses and birds (fowls and pigeons) are also used for experiment in special cases.

Cats are difficult to handle, and dogs are only slightly susceptible to most of the organisms pathogenic to man.

Frogs are occasionally used, but they are not very susceptible.

Ground squirrels [*Mus citullus*] are not only difficult to get in this country, but they do not breed in captivity.

Monkeys, and especially the anthropoid apes, have for some time been little used for experimental purposes on account of the difficulty of obtaining them, their initial cost, and the great care with which they have to be tended in captivity. Nevertheless, the work of Metchnikoff and his pupils on syphilis, [of the English Commission on tuberculosis, of Levaditi and Landsteiner on acute polio-myelitis, etc.] has shown the value of experiments upon these animals in the investigation of human disease. [*Macacus rhesus* is the most suitable—for most purposes—and at the same time the cheapest monkey.]

SECTION II.—THE KEEPING OF ANIMALS.

A. Small animals.

Accommodation.—The “small animal” house ought to be spacious, well ventilated, floored with concrete or some similar impervious material and have water laid on, so that it can be frequently washed down.

Animals generally, and especially monkeys, rabbits, mice and rats, are very susceptible to cold and damp; the animal house must, therefore, be kept dry, and facilities for warming it in winter should be provided.

Cages, feeding, etc.—The cages should, as far as possible, be made of metal. It is a bad practice to place one cage on top of another, since fluids from the upper cage may soil [and infect] the one beneath. If, from want of space, it becomes absolutely necessary to place one cage on top of another there must be a sheet of metal between them tilted and guttered, so that the urines run off. The bottom of the cages should always be perforated.

[A rectangular cage made entirely of fairly stout galvanized iron wire and resting on a metal tray is both efficient and cheap (fig. 129).

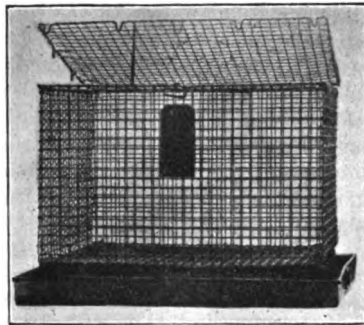

FIG. 129.—Animal cage. The cage is raised on blocks from the tray.

[The cage itself consists merely of a rectangular wire box of which one of the two largest sides is hinged to form a lid allowing access to the interior. A clasp must also be provided so that the top can be securely fastened down. The cage is placed on a sheet of galvanized iron turned up to the extent of 1 or $1\frac{1}{2}$ in. all round to make it water-tight and measuring 1 inch larger in

each direction than the cage. To clean, it is only necessary to lift the cage off the tray. It is an advantage to have two trays for each cage so that one may be disinfected and dried while the other is in use.]

The cages must be cleaned daily, and should an animal die or be removed to make room for a new occupant the cage in which it lived must be dipped in some strong antiseptic solution (phenol, lysol) or be sterilized by flaming it with spirit or with a large specially constructed gas burner (fig. 130).



FIG. 130.—
Gas burner
for flaming
cages.

Each cage should carry a label indicating the nature of the experiment, and the day upon which the animal was inoculated.

(i) **Rabbits, guinea-pigs, rats and mice.**—Rabbits and guinea-pigs can be conveniently kept in the cages described above.

Grey rats [*Mus decumanus*], as well as house [*Mus musculus*] and field [*Mus silvaticus*] mice should, as a rule, be caged singly. When several of these rodents are put in one cage they fight, and frequently kill each other. They are best kept in large wide-mouthed jars, the mouth being covered with metal gauze fastened down round the neck with iron wire.

White rats are frequently very tame, and can be kept in small-mesh wire-netting cages or bird cages, or even in wooden boxes fitted with a wire-netting door.

White mice should be kept in glass jars or metal boxes such as Palmer's biscuit boxes, the lid of which must be pierced with a number of holes. The floors of the boxes or jars, whichever be used, should be covered with a layer of sawdust several centimetres deep, and a little wool should also be put in the cage as mice do not like the cold.

There is no need here to discuss the proper feeding of rabbits, guinea-pigs, etc.

Mice and rats should be fed on corn and moistened bread. White rats are very fond of water, and a small dish containing it should, therefore, be put in their cages.

(ii) **Monkeys.**—Monkeys require a great deal of attention. Their cages must be large and be kept scrupulously clean. They are very susceptible to the cold, and the house in which they are kept ought, in these climates, to be artificially heated most of the year. The nature of the food required varies with the different species, but, generally speaking, milk,¹ dried fruits, [cooked rice], bananas and bread constitute the staple articles of diet of monkeys in captivity. They should be given something to drink twice a day, but it is advisable not to leave water [or milk] in their cages.

(iii) **Frogs.**—Frogs can be easily kept at ordinary room temperatures, but at temperatures approximating to that of the human body, such as are sometimes necessary under experimental conditions, they often die in a day or two without any apparent reason.

Ledoux-Lebard suggests the following as a useful method for keeping frogs (*Rana esculenta* is better than *Rana temporaria*) at a temperature of 35° or 37° C. for a month or more. Keep each frog in a bottle containing a few centimetres of water and covered with a piece of stout muslin tied on with string, renew the water daily with a fresh supply at the same temperature, and cram the frog once a week with beef, veal or mud worms.

Isolation of inoculated animals.—Inoculated animals must, of course, be rigidly kept away from the neighbourhood of normal animals.

[¹ It must not be forgotten that monkeys and apes are highly susceptible to tuberculosis, so that the milk must either come from an unimpeachable source or be sterilized before being fed to them.]

Breeding of small animals.—Rabbits, guinea-pigs, white rats, and white mice can easily be bred in the laboratory, and because of their inclination to kill the newly-born animals, it is as well to separate the males from pregnant females. This precaution is absolutely necessary in the case of rabbits and mice, but is less important with white rats and perhaps unnecessary for guinea-pigs.

B. Large animals.

[With regard to the housing of large animals such as cattle, sheep, pigs, etc., it is unnecessary to say more than that the houses or pens should be designed on lines similar to those in which they are ordinarily stabled. The structures should be light and well ventilated the floors concreted or cemented and well drained. The walls should be constructed of material which readily lends itself to efficient cleansing with antiseptics. If the stalls be of wood they should be limewashed out with lime mixed with 2 per cent. lysol before a new animal is introduced.]

SECTION III.—THE SPONTANEOUS DISEASES OF EXPERIMENTAL ANIMALS.

Laboratory animals are liable to certain infectious diseases with the more common of which it is important to be familiar because they are sometimes responsible for a heavy mortality among experimental animals.

Abscess.—Large abscesses containing thick, fetid pus not infrequently occur in rabbits in various parts of the body. They lead to a cachectic condition, and ultimately end in death. The disease is contagious.

The infected animal must be isolated and the cage carefully disinfected. Treatment consists in opening the abscess, evacuating the pus and gently curetting the wall, subsequently washing it out at frequent intervals, and dressing it with antiseptic dressings.

Acari.—An *acarus* sometimes develops in the external auditory meatus of the rabbit; it soon invades the middle ear, and causes serious nerve troubles, such as gyratory movements, convulsions and epileptiform seizures which lead to the death of the animal. The disease may be recognized by the yellow crusts which are seen in the rabbit's ear and which, if examined microscopically (Oc. 2, obj. A. Zeiss), are found to be composed of amorphous debris and numerous *acari*. The disease is highly contagious but yields to treatment if taken in hand in the early stages.

Immediately a case is found in the animal house, the infected individual should be killed, unless the experiment be of special interest, in which event it must be isolated and treated. Treatment consists in washing off the crusts formed on the auditory meatus daily with a sponge made by twisting a little piece of wool round a small rod, and dropping a few drops of a 0.5 per cent. solution of polysulphide of potassium (liver of sulphur) into the ear. The infected animal's cage, and those near it, should be disinfected and the ears of all the other rabbits in the house frequently examined.

Septicæmias.—Rabbits and guinea-pigs are subject to epizootic diseases which, only too often, decimate the population of the animal house in a few days.

As a rule, rabbits and guinea-pigs are affected at the same time. The animals curl themselves up, their coats are rough, and they suffer from a running from the nose and diarrhoea. Death soon follows these symptoms. *Post mortem*, lesions of broncho-pneumonia are seen. The disease appears to be due to a small bacillus morphologically similar to Pfeiffer's [influenza] bacillus.

Pasteurellosis.—Another disease, caused by an organism of the *Pasteurella* group (Chap. XXVIII.), is sometimes seen among rabbits. Infection is due to contamination of the food and floors of the cages with infected excreta. The animals are listless, suffer from diarrhoea and succumb rapidly. *Post mortem* : excess of fluid in the pleuræ, pericardium and peritoneum ; congestion of the lungs, intestines, etc.

Phisalix has described a disease caused by a *Pasteurella* similar to the canine pasteurella (Chap. XXVIII.) which may sometimes produce an epizootic among guinea-pigs.

Certain contagious **pneumonias** (Weber, Tartakowsky and others) may also attack laboratory animals.

When a septicæmic infection makes its appearance in the animal house, isolate the animals which are obviously or suspected to be infected and disinfect the house. It is even better, especially if there be any which it is particularly important not to lose (animals undergoing immunization, etc.), to remove the animals which are healthy to some other place altogether, and to transfer them to disinfected cages. Still it will often be difficult, whatever be done, to prevent the spread of the infection.

[Several epizootics resulting in a heavy mortality among the guinea-pigs in the small animal house and due to organisms other than those mentioned have now been recorded. From the internal organs bacilli of the **paratyphoid group** have been isolated (*B. Gaertner*, M'Conkey, Petrie, Bainbridge and O'Brien, *B. aertrycke*, O'Brien, Petrie and O'Brien). There is evidence, however, that these organisms were not, at least in some of the epizootics, the real cause of the disease, which appeared to be a **filter-passing organism** (Petrie and O'Brien), the paratyphoid bacilli being "secondary" infections.]

Coccidiosis.—Rabbits are frequently infected with *Coccidium oviforme* (*vide* Sporozoa). It is important that this fact be kept in mind and it should be noted that the disease is particularly troublesome in young animals.

Numerous other parasites may be found in experimental animals, and reference will be made to these in due course, more particularly when dealing with Tuberculosis, Glanders, Pleuro-pneumonia, the Pasteurelloses, the Hæmatozoa, the Trypanosomata, etc.

[**Pseudo-tuberculosis.**—Pseudo-tuberculosis is a most troublesome disease among guinea-pigs and rabbits not only because the naked-eye lesions so closely resemble the lesions produced by the tubercle bacillus but because so many animals become infected and die once the disease makes its appearance in the animal house. Pseudo-tuberculosis is the result of infection with a short stout bacillus with rounded ends which grows readily on agar at the temperature of the body. A feature which may arouse suspicion is the fact that the mesenteric glands are markedly affected which is, of course, not the case when an animal has been inoculated sub-cutaneously or intra-peritoneally with the tubercle bacillus. Infection apparently takes place through the alimentary canal. When the disease appears all the animals in the animal house must be isolated and as many as possible killed. It is a wise thing to destroy any food or bedding in stock and order a fresh supply.]

SECTION IV.—THE HANDLING OF EXPERIMENTAL ANIMALS.

Most animals struggle when they are caught and try to bite or scratch the person holding them. It is important to avoid these wounds, which may be dangerous, especially when the animal is infected with a disease transmissible to man, *e.g.* hydrophobia. A skilled worker should never be damaged by the animals he handles.

During an experiment the animal may be held either by the person operating or by an assistant. This is quite satisfactory in the case of most animals when a simple sub-cutaneous inoculation has to be done, but for the more difficult operations, such as inoculation into the peritoneum, meninges or veins, or when dangerous viruses, such as those of glanders, hydrophobia, etc., have to be inoculated, it may be better to hold the animal in some suitable form of apparatus designed for the purpose. [But as a matter of fact occasion for the use of such apparatus very, very seldom arises. If there is likely to be any difficulty this may be overcome by administering an anæsthetic. But for sub-cutaneous, intra-peritoneal or intra-venous inoculation not even an anæsthetic is necessary.] In the handling of small animals an assistant should be dispensed with as far as possible.

1. Rabbits.

To catch a rabbit grasp it by the skin of the back, or by one of its ears. These are the only ways to secure the animal without being scratched in the attempt. To hold a rabbit, place the animal on the knees, and hold it there with the left hand, using the right hand for the inoculation. If the animal be troublesome, take hold of the skin of the back with the right hand, and put the rabbit under the left arm, so that the head and fore limbs are fixed between the arm and the chest wall, support the trunk on the forearm, and hold the hind limbs with the left hand. The right hand is then free to make the inoculation.

When an assistant is available he turns the rabbit on its back and takes hold of the four limbs in his left hand, holding the head in his right in such a way that the top of the animal's head rests in the palm and his thumb passes under the lower jaw.

Apparatus for holding rabbits.—A rabbit can be very simply held by wrapping it up to its neck in a duster, or a large strip of cloth, and fastening the limbs beneath the body. Operations on the head and ears can then be performed. To inoculate one of the limbs, take it out of the duster, and hold it extended in the left hand.

To prevent the animal moving at all, several pieces of apparatus are available, for example, Malassez's, Czermak's, Piorkowski's, Latapie's, and Debrand's.¹ The two latter, which may be used for all the smaller animals, are very ingenious, but complicated and expensive. Latapie's apparatus is, moreover, difficult to disinfect.

The simplest and at the same time the best piece of apparatus consists of a rectangular sheet of zinc or copper, the edges of which are turned up and pierced with holes 2 or 3 cm. apart. Place the animal on the metal tray, put a noose (of string, or, better, leather) round one of the hind limbs and fasten it above the wrist, pass one of the ends through a hole near the end of the tray and tie it to the other end. In the same way fasten the fore limb of the opposite side to a hole at the other end of the tray. Then make the other two limbs fast. The animal is now absolutely unable to move. The head can be held by an assistant, or can be fixed with a string passing from a bar introduced behind the incisor teeth, and fastened as before to two holes of the tray.

Or the head can be held with a Ranvier's ring. This device consists of an horizontal iron bar moving on a vertical bar by means of a double joint, which allows it to be fixed in any position. The horizontal bar ends in a ring perpendicular to its axis, and on to the ring two small hooks are adjusted, to which a piece of elastic can be attached. Fit the ring on the animal's nose and attach the elastic to one of the

¹ *Annales de l'Institut Pasteur*, 1894 and 1900.

hooks, then pass it between the ears, and fasten the end to the other hook. The apparatus is fixed on to the tray by means of a screw clamp. The animal can be secured to the tray and its head held by the ring, either on its back or belly at will.

Anæsthetics.—Rabbits are very sensitive to anæsthetics. Chloroform should not be given either slowly or in small and repeated doses, because it will thus almost certainly kill the animal; but by giving a large dose to begin with and then stopping the administration after a few moments accidents can almost always be avoided.

Twist two or three thicknesses of filter paper into a cone, pour a teaspoonful of chloroform on to it and hold it over the animal's mouth. Respiration stops after a few seconds but soon begins again; at this moment anæsthesia is complete; the administration of chloroform should now be stopped, and the operation quickly performed.

2. Guinea-pigs.

It is best to catch guinea-pigs by the skin of the back; they are easier to handle than rabbits, and can generally be held in the left hand, leaving the right hand free for inoculation.

If it be desired to hold a guinea-pig with instruments the simplest way is to catch hold of the animal by the skin of its back with a large pair of pressure forceps, the grasping ends of which are ring-shaped (fig. 131). The

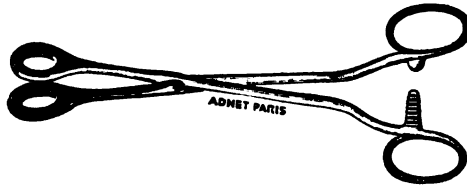

FIG. 131.—Forceps for grasping small animals.

forceps being clipped together are hung by one of the finger holes on a nail in the wall, and the animal being thus suspended is rendered quite motionless.

For holding guinea-pigs still while taking temperatures, making inoculations into the hind limbs, etc., it will be found convenient to secure the anterior part of the animal in a metal cylinder with slits along the sides.

For carrying out delicate operations, it is preferable to fix the animal on the tray described above. Such trays should be kept in two sizes, the larger ones for rabbits and the smaller for guinea-pigs.

Anæsthetics.—Guinea-pigs are less susceptible to chloroform than rabbits. It is very seldom that they have to be anæsthetized, but should it be necessary to give a guinea-pig an anæsthetic, the method of administration is the same as for rabbits.

3. White mice and white rats.

To catch the animals.—These species are perhaps in a general way more used for experimental inoculation than any other "laboratory animal." They can be caught by the tail with the fingers. Sometimes they struggle and may inflict a painful bite; this can be avoided by grasping them by the tail or skin of the neck with a pair of forceps.

To hold them for inoculation, the only method that can be recommended is to catch hold of the tail with the fingers or a pair of forceps and draw it out of the pot, the animal being thus suspended head downwards inside; then, as a precaution against being bitten put a small piece of board over the

mouth of the jar so that only the tail projects. Inoculation can now be made at the root of the tail. If it is necessary to inoculate into one of the limbs, pull the limb out of the jar with a pair of forceps. [The inoculation can however be performed in the following manner which is we think simpler than that just described. Let an assistant catch the rat by the tail and hold the hind limbs with one hand and the fore limbs with the other at the same time wrapping a small cloth loosely round the animal's head. The inoculation can now be made by the operator into any part of the animal's body. If the rat bites it does not damage the cloth.]

Anæsthesia.—For all delicate operations it is better to anæsthetize the animal. Rats and mice are easily killed by chloroform, but take ether well.

Put the animal under a bell jar with a small piece of absorbent wool soaked in ether; or the wool can be put straight into the jar in which the animal is living. When it falls over motionless take it out of the bottle and fix it on a small tray; in the case of rats, if necessary, put on a Ranvier's rabbit as well, or use a Debrand's apparatus. Anæsthesia can be prolonged by giving a little ether from time to time.

4. Grey rats.

Grey rats [*Mus decumanus*] struggle vigorously and may give very nasty bites. They can only be caught with a pair of large strong forceps, such as those described above (fig. 131).

Pass the forceps into the bottle containing the rat and catch hold of the animal quickly wherever it is possible to do so. The rat at once attacks the forceps and bites them; while the animal is thus engaged, fix a second pair of forceps on to the skin of the neck, clamp the two pairs of forceps firmly and lift the animal out of the bottle.

During the inoculation, an assistant holds the rat securely with the two pairs of forceps, inclining the forceps fastened to the neck towards the vertebral column in order to pick up the tail with the same hand. With the other hand he takes the other pair of forceps and pulls on them gently so as to make it impossible for the animal to use his teeth. If this second pair of forceps was badly fixed, the skin over the lower jaw should be held with another pair. When the operation is done place the rat safely inside the bottle again before releasing the forceps.

Anæsthesia.—Grey rats should always be anæsthetized before beginning a difficult or dangerous inoculation. Put a pledget of wool soaked in ether in the bottle, and proceed as already described in the case of white rats.

5. Dogs.

If the dog be a quiet animal catch hold of him firmly by the skin of the neck. When dealing with a surly or snappy dog use a special pair of long iron forceps (*pince à collier*), which, when closed, form a collar round the animal's neck. Alternatively, throw a noose round the animal's neck and fasten the loose end to a bar of the cage or a post; as the dog pulls the noose tightens, the animal falls over half suffocated, and the opportunity is taken to slip on a muzzle and tie its feet.

Muzzling.—No operation should be performed on a dog without muzzling it beforehand. The simplest method is to pass a piece of stout string into the animal's mouth behind the canine teeth, make a simple knot below the jaw, bring the two ends up and tie them in a double knot on the nose. Or, after passing a stout round iron wire behind the canine teeth, take two turns

with a piece of string round the muzzle behind the bit, tighten the ligature and fasten the ends securely.

If it be necessary to gag the animal with the mouth open for the purpose of passing a catheter into the stomach, use a Claude Bernard's bit with a double transverse branch.

Instead of the bit a rectangular wooden gag of a size suitable to the animal, and pierced with a hole in the centre may be used. After placing this gag in the mouth behind the canine teeth fix the jaws with string.

Method of holding dogs.—After muzzling, the dog can generally be held with the hands. For long operations the animal should be held with Claude Bernard's, Malassez's, or Debrand's apparatus, or more simply by fixing it by the feet, as has been described in the case of the rabbit, on to a heavy wooden table perforated with holes or fitted with hooks through which strings can be passed.

Anæsthesia.—It is rarely necessary to anæsthetize dogs in bacteriological work. The animals take chloroform well, provided that large doses are not given, and the liquid does not come in contact with the nasal mucous membrane.

In giving an anæsthetic a long muzzle is generally used, ending in a small perforated box in which a sponge soaked in chloroform is placed. The administration can be suspended or continued at will by taking off or replacing the box on the muzzle. Small doses should be used to begin with. Anæsthesia is complete after 8–15 minutes.

6. Cats.

Cats are very difficult to manage, and are rarely used for bacteriological experiments. It is best to take hold of them firmly by the skin of the back; or, if the cat be wild, adopt the noose method described above for dogs.

In operating on a cat it is well to anæsthetize it. As soon as it has been caught, put it into a large wide-mouthed jar in which there is a sponge soaked in chloroform, and cover the jar at once. Cats are very sensitive to chloroform, and the animal must be taken out of the jar as soon as it falls: anæsthesia will continue for several minutes without any further administration. The animal may either be fixed on to the table already described, or may be wrapped up in a large duster with the feet under the belly, the head and anterior part of the body being pushed into a sack. This is an excellent method for inoculations into the posterior part of the body, rectal injections, etc.

7. Monkeys.

Monkeys especially *Macacus rhesus* are also difficult to manage [and are so active that it is hard to catch them, if their cage be at all large. Wear rough leather gloves and grasp the animal by the body or limbs, then take a fresh grip, of] the skin at the back of the neck, and treat them in the same way as dogs. It is necessary to chloroform them if the operation is likely to last any length of time.

8. Horses and Asses.

Horses can nearly always be inoculated without adopting any special method for holding them. It is enough for an assistant to hold them with a bridle or halter. If a horse be nervous its eyes may be covered, and should it struggle, a twitch may be used or one of its fore legs flexed and fastened. For longer operations the horse may be shackled and thrown by methods

well known to people who have to do with horses. Vinsol's apparatus is to be strongly recommended, but unfortunately it is very expensive.

9. Cattle.

Bovine animals are, as a rule, easily managed. For long operations the animal is thrown on a vaccination inoculation table, or placed in a Vinsol's apparatus.

10. Birds.

Fowls and other birds ordinarily used for inoculation are easily held with the hand. They may be secured by their feet and wings on the metal tray described on p. 161, or on a Debrand's apparatus.

Note.—After every operation, all bits, gags, dishes, etc., which have been used must be carefully cleaned and washed with a solution of carbolic acid, [lysol or] formalin, and the antiseptic washed off, of course, with water before the instrument is used again.

SECTION V.—EXPERIMENTAL INOCULATIONS.

1. Instruments.

There is no need to go into details with regard to instruments in common, every-day use such as are required for making incisions, exposing vessels, etc. Bistouries, scissors, forceps, retractors, inoculation needles, suture needles, etc., must all be sterilized before an operation either in the hot air sterilizer at 180° C. or by boiling in water for 10 minutes, and then transferring to a 0·1 per cent. solution of oxycyanide of mercury [or 2 per cent. lysol]. When the operation is over the instruments must be cleaned, passed through alcohol and dried with a piece of soft cloth.

Sterile absorbent wool, thread and silk should be at hand, ready for use when needed.

Preparation of sterile silk.—(a) The silk may be sterilized just before it is wanted by boiling it for 15 minutes in 3 per cent. carbolic acid. But it is better to keep a quantity in stock prepared by one or other of the following methods:

(b) Cut the silk into lengths of about 12 inches and wrap three or four lengths in two or three pieces of filter paper. Prepare a number of these packets of silk and heat them to 120° C. in the autoclave, dry them in the incubator and keep them in a well-stoppered bottle in a box with a tightly-fitting lid. Open the packets one by one as they are wanted. Any packet which has been opened and not used must be thrown away.

(c) Place the reel of silk and a little water in a small bottle. Pass the end of the silk through a narrow piece of glass tubing which should perforate the cork of the bottle and be plugged with wool (fig. 132). Sterilize in the autoclave. When the silk is wanted it is only necessary to pull on the end of it to unreel it. So much of the silk thread as projected before it was pulled must of course be cut off and thrown away. The silk in the bottle will keep sterile so long as the wool plug remains in position.

A solution of some antiseptic (e.g. 0·1 per cent. oxycyanide of mercury) [or 2 per cent. lysol] and some sterile water must also be at hand.

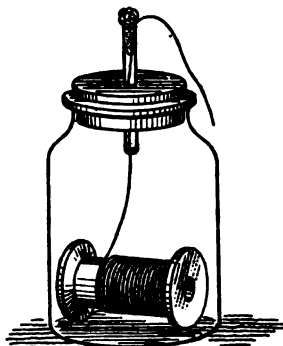

FIG. 132.—Bottle for storing sterile silk.

The silk in the bottle will

Preparation of sterile water.—A number of test-tubes or small flasks of 50–100 c.c. capacity should be three-quarters filled with water and sterilized at 115° C. When wanted, aspirate the water out of the tubes or flasks with a Pasteur pipette. The contents of any tube or flask opened and not used should be thrown away at once.

Water may also be sterilized in larger quantities in flasks: but it is better to use small vessels containing only sufficient water for one experiment. All risk of contamination is then avoided.

A number of sterile glass dishes, glass rods, platinum wires and Pasteur pipettes must also be ready.

Lastly, *syringes* and *needles* are necessary with which to inoculate the virus into the tissues.

(i) Inoculation syringes.

There are numerous patterns of inoculation syringes, and this fact in itself shows how difficult it is to obtain a syringe which fulfils all the conditions required of it. A satisfactory syringe should—

1. Lend itself to sterilization in boiling water or in steam under pressure.
2. Have perfectly water-tight joints and plunger, and be so constructed as not to need frequent renewal of the parts.
3. Be accurately graduated on the glass barrel or piston rod.

Pasteur pipettes.—A Pasteur pipette may on occasion be used as an inoculation syringe. And for this purpose the drawn-out part is made short and slightly curved, with a sharp point (fig. 133). [The opposite end is plugged with wool and the pipette sterilized before use. A small bulb may be very conveniently blown on the tube.] The liquid to be inoculated is sucked up into the pipette and the pointed end pushed through the skin [or, when required, into the peritoneal cavity], and the material deposited in the tissues by blowing through the plugged end. This is all the apparatus that is necessary in a large number of cases.

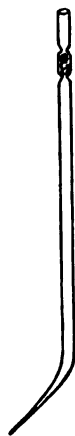

FIG. 133.—
Pasteur pipette
modified for in-
oculations.

A. Older patterns.—Of the older patterns of syringes the use of which is now being given up, the following may be mentioned:

Pravaz's syringe.—One of the oldest and at the same time one of the best from the point of view of the security of its joints is Pravaz's syringe. But, unfortunately, the joints and the leather plunger will not stand the temperature of boiling water. If it be used it must be disinfected by soaking it in a 5 per cent. solution of carbolic acid for several hours and subsequently rinsing well in sterile water.

Syringes with air piston.—Koch, Petri and others eliminated the plunger. The glass cylinder forming the body of the syringe was fitted at one end with a needle and at the other with an india-rubber ball: by squeezing the ball, the liquid was forced out. When used for injection however especially into tense tissues, the liquid either cannot be inoculated or runs out when the needle is withdrawn. These syringes are not now in use.

Straus' syringe.—By substituting compressed elder pith for the leather in Pravaz's plunger, Straus obtained a syringe which stands the temperature of boiling water and of the autoclave very well. The plunger can be changed as often as is necessary, but though it is easily done it takes some time; moreover it has to be done frequently since the elder pith rapidly loses its elasticity. With these reservations the syringe is a good one.

To renew the plunger.—Take a piece of elder pith with a regular and fine grain, cut off the outer, fibrous layer, and compress it between the fingers so as to flatten it longitudinally as much as possible. Then cut out a small cylindrical piece to fit the barrel of the syringe tightly. Perforate its centre with a needle heated to redness in the flame and fix it on to the end of the piston rod. Then with a very fine file polish its sides and introduce it into the barrel. By soaking in water for a few minutes the elder pith swells and the plunger becomes water-tight. The pith can also be compressed at will by means of the screw at the top of the piston rod.

In Roux's modification the glass barrel is narrowed below and ground so that the needle is fitted directly on to it. The plunger can be freely withdrawn or inserted since the tube is merely fitted above with a plug.

Malasser's syringe.—There are several patterns of this syringe. The only ones which can be recommended are those in which the plunger consists of a mixture of india-rubber and asbestos, or of "fibre," a combination of cellulose and rubber. The lower end is narrowed and ground and the needle fitted on to it by means of a "fibre" washer.

Metal plunger syringes.—In these forms the elastic plunger is replaced by a rigid piston consisting of an accurately calibrated metal rod, the body itself being an hollow metal cylinder. These syringes soon deteriorate and are inconvenient in that the liquid within them is not visible.

B. Patterns recommended for use.

Roux's syringe (fig. 134).—For serum-therapeutic inoculations, Roux devised a syringe of 20 c.c. capacity with a plunger made of some rubber preparation. The needle is connected to the nozzle of the barrel by a piece of rubber tubing about 10 cm. long. This arrangement allows the injection to be forced into the tissues without the risk of detaching the needle. Before sterilizing the syringe be careful to loosen the upper socket to leave the glass barrel room to expand, and so prevent it being cracked.

Debove's syringe (fig. 135).—In the author's opinion Debove's syringe is better than Roux's. It is both easy to manipulate and easy to sterilize: it is solid and perfectly water-tight and can be used for all sorts of inoculations.

The syringe consists of a glass tube held between two metal sockets by means of a movable metal armature which is entirely distinct and controlled by a lever. The barrel is accurately calibrated and the syringe is made water-tight with asbestos washers.

The lower metal socket has a conical extension on to which the needle fits either directly or through an india-rubber connexion.

The plunger consists of asbestos rings held between two metal discs. The piston rod carries a screw which allows the pressure on the asbestos rings forming the plunger to be varied so that the play of the plunger can be regulated.

The syringe is easily taken to pieces by raising the lever; this relaxes the lateral stays which can then be disconnected and the sockets taken off.

All parts of the syringe are made to a standard pattern, so that broken parts can be replaced without sending it to the maker to be repaired. The syringe is made in several sizes to hold from 2–100 c.c., those ordinarily in use being of 2, 10 and 20 grams' capacity.

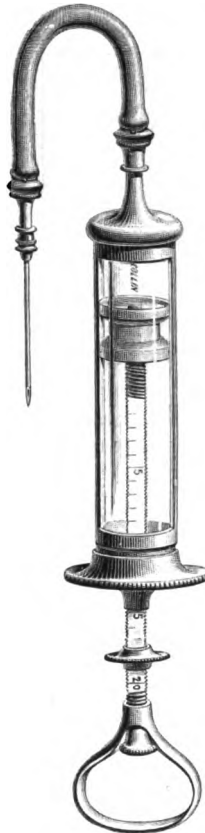

FIG. 134.—Roux's syringe.

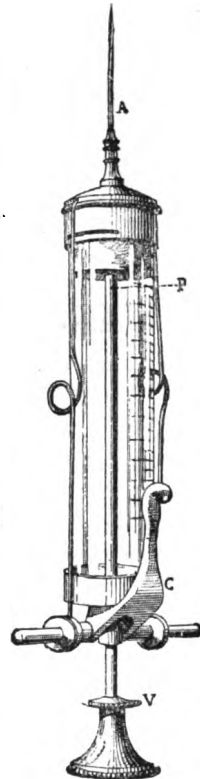

FIG. 135.—Debove's syringe.

Method of sterilizing Debove's syringe.—Withdraw the plunger as far as possible, raise the lever to relax the spring and allow expansion of the glass cylinder. Place the syringe and needle in a vessel of cold water and heat to boiling for 15 or 20 minutes. Let the syringe cool; then take it out of the water with a pair of sterile forceps, let the water above the plunger run out, lower the lever and fit the needle on its socket.

(When the syringe has been used for an injection, rinse it out in cold water to wash out all albuminoid matter—which would coagulate on boiling—and boil it in the same water, so that both the latter and the syringe are sterilized at the same time.)

The syringe may be sterilized in the autoclave if preferred: it is prepared as above and then heated to 115° C. for a quarter of an hour. In most cases, boiling is sufficient to completely sterilize it, but when it has been used for inoculating cultures of spore-bearing bacilli, such as *B. tetani*, *B. maligni oedematis*, etc., it should be autoclaved.

Syringes with glass pistons.—Malsesse has had a syringe made by Luer which is entirely of glass. The piston itself consists of a calibrated glass rod. Numerous forms of syringes based on this pattern can now be bought at a low price.

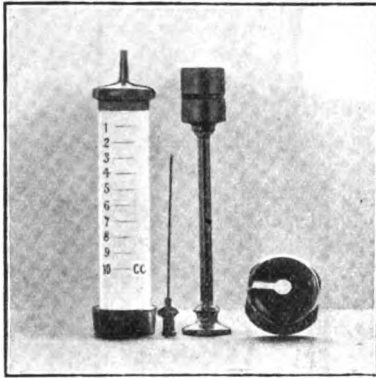

FIG. 136.—Another reliable form of syringe ("The Record").

These syringes are easily sterilized quite water-tight and are excellent in every way, particularly for small volumes (1–2 c.c.).

Apparatus for injecting large quantities of fluid.—In immunizing animals with toxins when large quantities of filtered cultures are inoculated, syringes are not large enough, and moreover the fluid cannot be injected sufficiently slowly. In these cases the following arrangement is useful (fig. 137).

The liquid to be inoculated is poured into a tall glass vessel graduated on the glass from above downwards and closed with an india-rubber plug which is perforated by two glass tubes, one of which, reaching to the bottom of the vessel, has a needle attached to its upper end with india-rubber tubing. The other tube passes a few centimetres below the stopper, is plugged with wool, and through it the air in the vessel can be compressed. When this is done the liquid flows out of the needle, and the rate of flow can be regulated at will.

The apparatus is sterilized in the autoclave and then the liquid to be inoculated aspirated into the vessel.

(ii) Needles.

Steel needles are very generally used for inoculations. The disadvantage of steel is that it so readily rusts with the result that the lumen of the needle soon becomes obstructed. This difficulty is overcome by carefully washing the needles after use, and keeping them—after they have been sterilized by boiling—in a small

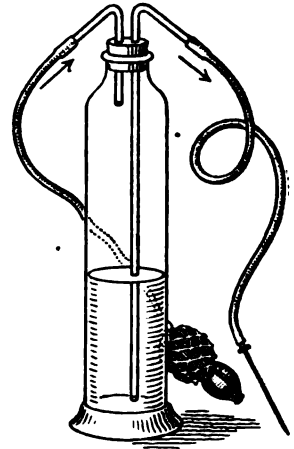

FIG. 137.—Apparatus for inoculating large volumes of liquids.

bottle filled with absolute alcohol [to which a few lumps of calcium chloride may with advantage be added] or in a 3 per cent. solution of sodium borate.

On account of the difficulty of preventing steel from rusting platinum-iridium needles are gradually replacing steel. Platinum-iridium does not rust and the needles can be heated to redness. On the other hand they are expensive and delicate and as they are but little stronger than needles made of pure platinum, it is on the whole better to use steel especially when a thick skin has to be penetrated as is generally the case in animal inoculation.

A selection of needles of different calibre and of different lengths ought to be kept in the laboratory.

2. Preparation of the material for inoculation.

The material to be inoculated may be either a solid or a liquid. The procedure will be different in the two cases.

(i) Of fluids.

Broth cultures are the commonest fluids inoculated but other fluids, such as blood, serum, pleural and peritoneal exudates, have also to be inoculated at times.

(a) **Cultures.**—*Every culture should be examined microscopically before being inoculated, to test its purity.*

When ready to perform the inoculation remove a little of the culture with a Pasteur pipette and transfer it to a sterile watch-glass and cover the latter again with the paper in which it was sterilized. Aspirate the culture into a sterile syringe through the needle either by puncturing the paper with the needle or by slightly raising the paper and passing the needle beneath it. Hold the syringe with the needle pointing upwards and gently press the plunger to expel any air which may have been drawn into the syringe, taking care to hold the piece of sterile paper which covered the watch-glass alongside the needle to catch any drops of culture which may inadvertently be driven out. Burn the paper and dip the watch-glass into a vessel of boiling water to sterilize it.

(b) **Exudates.**—Blood and serous exudates must be collected in the manner to be described in Chaps. XI. and XII. With a pipette transfer the amount required for inoculation to a sterile watch-glass and proceed as above. It is very difficult to inject blood directly because it so readily coagulates and blocks the needle. If the virus pass into the serum, the blood should be allowed to clot and the serum used for inoculation. On the other hand if the virus be retained in the clot this should be dealt with as though it were a solid tissue (*vide infra*).

To facilitate the inoculation of whole blood it is occasionally necessary to have resort to the anti-coagulating action of sodium citrate. The blood is collected in a sterile vessel containing a little of the following solution also sterilized:

| | | | | | | | |
|--------------------|---|---|---|---|---|---|------------|
| Water, - | - | - | - | - | - | - | 1000 c.c. |
| Sodium chloride, - | - | - | - | - | - | - | 8 grams. . |
| Sodium citrate, - | - | - | - | - | - | - | 15 .. |

Use two to four volumes of the citrate solution to one volume of blood. Mix thoroughly and inoculate without delay.

(ii) Of solid substances.

(a) **Solid substances.**—Fragments of internal organs, splinters, etc., may be inserted directly into the tissues of the animal. After making a small incision separate the cellular tissue with a director and introduce the material into the pocket so formed, suture the wound and cover it with collodion. Material may be similarly introduced into the peritoneal cavity, muscles, etc.

(b) **Cultures on solid media.**—A small incision may be made in the skin and then a wire, charged with the micro-organisms by scraping the surface of the medium, rubbed into the tissues. But it is more usual to make an emulsion by rubbing up some of the material in sterile water or broth and then to inoculate the emulsion with a syringe.

Scrape the surface of the medium with a stout platinum wire and transfer the growth to a sterile watch-glass containing a little sterile water and stir it about until an homogeneous emulsion is obtained. If the culture be difficult to break up—as, for example, a growth of the tubercle bacillus—and does not mix with water, it should be ground up as described below (d).

(c) **Pus.**—As a rule, pus is too thick to be inoculated undiluted. Transfer a few drops of the pus with a pipette to a sterile watch-glass, add a little sterile normal saline solution (0·8 per cent. aqueous solution of sodium chloride) or broth and mix them thoroughly with the end of the pipette.

(d) **Fragments of organs.**—For the method of collecting fragments of internal organs, portions of the central nervous system, etc., see Chap. XI.

Transfer the material to a sterile watch-glass and break it up with a sterile glass rod. When the tissue is reduced to a fine paste add a little sterile normal saline solution drop by drop from a pipette, and mix until a quite homogeneous suspension is obtained.

It is often necessary to filter the suspension through a small piece of previously sterilized fine muslin to get rid of little lumps. This precaution is very necessary when the emulsion has to be inoculated intra-venously, in order to avoid the formation of an embolus.

When a very tough material has to be dealt with such as tuberculous or leprous nodules, it should be cut up into quite small fragments with sterile scissors, ground up in a sterile mortar with some fine sterile sand¹ (p. 155) and a fluid emulsion made by adding sterile normal saline solution drop by drop: the emulsion is then filtered through fine, sterile muslin before being inoculated.

When a larger quantity of material has to be emulsified, Borrel's *broyeur* will be found useful. With this machine fine powders or emulsions can be obtained without contaminating the material and without exposing the operator to the inhalation of dust containing pathogenic organisms.

3. Technique of inoculation.

General rules.—Before inoculating an animal shave the hair and cleanse the skin of the part.

The hair may be cut very short with a pair of curved scissors but it is better to shave the skin. For delicate inoculations it is preferable to epilate the hairs with one of the following solutions:

- | | |
|------------------------------------|----------|
| 1. Recently slaked lime, | 2 parts. |
| Water, | 3 " |

Pass a stream of hydrogen sulphide through the emulsion, shaking it frequently, until it is saturated. Apply the paste to the part to be epilated and after a few minutes wash it off with water and a nail brush.

- | | |
|-------------------------------|----------|
| 2. Sodium sulphide, | 3 parts. |
| Powdered quicklime, | 10 " |
| Starch, | 10 " |

Mix into a powder. When required for use, add sufficient water to a little of the powder to form a soft paste and apply it to the skin. After 3 or 4 minutes' application the hair is removed.

[¹ Sand was used as a triturating agent by Cobbett in his earlier experiments on tuberculosis but was almost immediately given up. A little patience is all that is required to grind up even a tough tuberculous lesion.]

In a large number of cases it is only necessary after cutting the hair, to rub the skin with a [2 per cent. solution of lysol or a] 0.1 per cent. solution of oxy-cyanide to render it aseptic. But for more perfect asepsis the skin should be scrubbed with soap and a nail brush, washed with an antiseptic solution, rinsed with alcohol and wiped with sterile filter paper.

(i) **Intra-dermal inoculation.**

1. Shave and cleanse the part but use no antiseptics.
2. Scarify the skin very superficially with a bistoury, or pick up the skin in the fingers and shave off the epidermis with the blade of a sharp knife.
3. Rub the material to be inoculated into the prepared part with a sterile glass rod or a piece of sterile wool held in a pair of forceps.

In some cases, it is sufficient merely to rub the skin briskly with a sponge soaked in the material without scarifying or scraping the surface.

As a rule, the material should be inoculated into some part of the skin of the body which the animal cannot reach, such as the dorsal surface of the ear, the skin of the back, or the root of the tail. This rule applies to the inoculation of all species of laboratory animals. For some viruses there are special sites used for inoculation, the eyelids or eyebrows in syphilis, for example.

(ii) **Inoculation on the surface of mucous membranes.**

Abrade the surface of the mucous membrane, as in the preceding case, by scraping it with the blade of a knife, and spread the virus over the surface thus abraded. Sometimes it is better, before inoculating the mucous membrane, to cauterize it with a moderately hot iron or platinum rod so as to produce a superficial slough.

(iii) **Sub-cutaneous inoculation.**

- A. Of a liquid.**—1. Shave and cleanse the skin.
2. Pick up a fold of skin between the thumb and index finger of the left hand, insert the needle at the base of the fold, inject the fluid and withdraw the needle. Care must be taken to see that the fluid does not find its way out again through the needle puncture and that the injection is not made into the muscles. [By lightly pressing the fold in which the puncture has been made between the finger and thumb and twisting it gently, exudation through the puncture can almost always be prevented.]

B. Of a solid.—1. Shave and cleanse the part.

2. Make a small incision through the skin with a bistoury, separate the sub-cutaneous tissue with a director over a sufficient area and then introduce the material to be inoculated into the pocket with a pair of sterile forceps.
3. Put a stitch or two into the incision and cover it with a little collodion.

Note.—As has already been stated above, inoculations are most satisfactorily made into some part of the body that the animal cannot reach; they are however often made beneath the skin of the abdomen or thigh.

When the material to be inoculated is solid, some part of the body where the skin is very loose should be chosen, as for instance, the flanks or the groin.

(iv) **Inoculation into lymphatic spaces.**

In the frog, inoculations are frequently made into the sub-cutaneous connective tissue which consists of large inter-communicating lymphatic sacs.

A. Dorsal sac.—The dorsal sac is situated over the posterior part of the back. The animal's hind limbs are wrapped in a cloth so that it cannot move, and by compressing the sides of the back with the fingers the sac is

made to stand out. A fine needle is introduced obliquely into the sac from above downwards and the material injected.

B. The posterior limb sacs.—Introduce a needle obliquely from above downwards under the skin below the femoro-tibial joint and inject the material.

(v) **Intra-muscular inoculation.**

1. Shave and cleanse the part.
2. Push the needle deeply into the muscles, inject the material and withdraw the needle.

Inoculations are made for preference into the muscles of the thigh in the mammalia, and into the pectoral muscles of birds.

(vi) **Intra-venous inoculation.**

Whenever possible intra-venous inoculation should be made into a superficial vein. The needle may be passed through the skin directly into the vein without first exposing the latter. Intra-venous inoculation cannot be effected in the case of very small animals such as mice.

A. Rabbits.—1. One of the dorsal veins of the ear, and, for preference, the external marginal vein should be selected. Avoid the median veins, because, being embedded in a lax cellular tissue, they are liable to slip away from under the needle.

2. Cut the hair over the vein with a pair of curved scissors [or better, shave

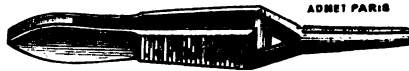

FIG. 138.—Pressure forceps for the ear vein.

it], and cleanse the skin. The rabbit is placed on the operator's knee and, if necessary, held by an assistant.

3. Take hold of the margin of the ear between the index finger and thumb of the left hand so as to extend it. Put a pair of pressure forceps on the vein at the base of the ear so as to make the vein prominent (fig. 138).

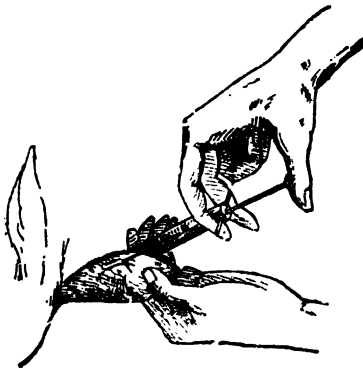

FIG. 139.—Inoculating into the ear vein of a rabbit.

By rubbing the skin with a sponge soaked in warm carbolic water the vein can be rendered more distinct.

4. Hold the needle very obliquely, almost parallel to the vessel and pierce it in the direction of the blood-stream (fig. 139).

5. When the needle is in the vein, take off the forceps and inject the fluid slowly. It is a good plan to apply the forceps higher up on the needle itself, so as to hold it in the skin. If the needle has missed the vein, the injection will cause a subcutaneous swelling, and the operation must be begun again lower down.

After the fluid is injected withdraw the needle, and if the vessel bleed leave the forceps on the bleeding point for a few minutes, [or pass the vein between the finger and thumb moving them against the blood-stream].

B. Guinea-pigs.—The superficial veins are not large enough in the guinea-

pig for intra-venous inoculation, and recourse must be had to the external jugular. This vein is superficially situated, lying beneath the skin the sub-cutaneous muscles and some cellular tissue, and follows a line from the angle of the jaw to a point mid-way between the shoulder and the sternum.

1. Fix the guinea-pig on its back, with its head extended. Shave and cleanse the part.

2. Make an incision through the skin and sub-cutaneous muscles in the middle of the line described above, tear through the cellular tissue with a director, and the vein will be exposed lying to the outer side of the incision.

3. Pass the needle obliquely into the vein (it is very convenient to have a needle with the lower end bent at a right angle) inject the fluid and withdraw the needle.

4. Cleanse the wound with a sponge soaked in carbolic water and make quite sure that there is no bleeding from the prick in the vein. Put two or three stitches in the skin and cover the incision with collodion.

C. Dogs.—For intra-venous inoculation in dogs the external vein of the hind limb—the small saphenous—should be selected.

1. Muzzle the animal, and get an assistant to hold it.

2. Shave the skin on the outer side of the limb where the calf muscles are inserted into the *Tendo achillis*. Compress the limb above, and rub the shaved part with a sponge soaked in carbolic water. The small saphenous vein will thus be made to stand out and is easily accessible at the upper part of the *Tendo achillis*.

3. Avoid, if possible, having to expose the vein, and in performing the inoculation pierce the skin and the vein at one and the same time.

D. Horses and Cattle.—Locate the jugular vein and render it prominent as described on p. 49. Make the injection with the usual precautions.

E. Birds.—Birds are best inoculated intra-venously in the axillary vein.

1. Fasten the bird down, and let an assistant extend the wing, and at the same time compress the base. Pluck the down from the inner surface of the root of the wing, and rub the part with a sponge soaked in carbolic water.

2. When the vein has swelled, inoculate the material.

(vii) Arterial inoculation.

In mammals for purposes of arterial inoculation the femoral or carotid artery is chosen.

A. Femoral artery.—The femoral artery takes the same course in animals as it does in man. In the fold of the groin, the vein is on the inside, the artery next and the crural nerve on the outer side. The artery takes a line from the middle of the fold of the groin to the inner side of the knee.

1. Fix the dog on its back. Rotate the leg outwards and extend it. Shave and cleanse the part.

2. Determine the exact position of the artery by finding the pulse near the middle of the fold of the groin, and make an incision through the skin and sub-cutaneous tissue, a few centimetres long, along the line of the vessel.

3. Divide the aponeurosis on a director and the sheath of the vessels and nerve will be exposed.

4. Having found the artery prick it very obliquely, inject the material and withdraw the needle.

5. Put a few stitches in the skin and paint the wound over with collodion.

B. Carotid.—In all mammals, the carotid artery lies in close relation to the trachea in the middle of the neck, being contained in a sheath common to it, the internal jugular, the pneumogastric and the great sympathetic.

1. With the animal lying on its back and its head extended shave the skin of the middle of the neck and wash it with an antiseptic.

2. Make a longitudinal incision, a few centimetres long, in the middle line, in front of the trachea.

3. Divide the aponeurosis connecting the two sterno-mastoids on a director.

4. Separate the cellular tissue along the trachea with the rounded end of a probe and then, by pulling the sterno-mastoid outwards, the sheath of the vessel will come into view.

5. Open the sheath with a pair of forceps and a director. The artery will be recognized from the vein by its larger size. Make the injection as described above.

(viii) Intra-peritoneal inoculation.

A. Of a fluid.—Every precaution should be taken not to perforate the gut.

1. Fix the animal firmly on its back. [An assistant can hold it equally well.] Shave and disinfect a few square centimetres of the skin of the abdomen.

2. Pick up the whole thickness of the abdominal wall between the thumb and index finger of the left hand.

3. Insert the needle of the syringe into the base of the fold in such a way that the point is directed upwards, withdraw it a little, and then, altering the direction of the point, pass it into the cavity of the abdomen. Inject the material and withdraw the needle.



FIG. 140.—Needle for intra-peritoneal inoculation.

The following method affords greater security. A curved needle is used, in which the opening is situated in the centre of the concavity of the arc (fig. 140).

Insert the needle through the whole thickness of the abdominal wall, including the peritoneum, and bring the point to the surface; the needle-opening is now within the peritoneal cavity, and the material is injected. The point of the needle being outside all the time that the injection is being made no injury can be done by it to the gut.

B. Of a solid.—1. The animal is fixed on its back, and the skin of the part shaved and cleansed.

2. Make an incision in the median line, the length of the incision varying with the size of the substance to be inoculated.

3. Cut through the aponeurosis, using a director to avoid injuring the intestine.

4. Take hold of the aponeurosis on each side with pressure forceps, and hold it up as much as possible to prevent the intestines protruding. Introduce the material to be inoculated into the wound and push it well under the muscular layer into the peritoneal cavity.

5. Sew up the aponeurosis with silk, stitch the skin and cover the incision with a layer of collodion.

Note.—The most careful asepsis is necessary in performing intra-peritoneal inoculations. These inoculations should always be done with pure cultures or with material which can be obtained free from contaminating organisms for, if sputum, excreta, etc., are injected into the peritoneal cavity the animal will very quickly die of peritonitis. [But see Chap. XVIII. Sect. IV.]

C. Collodion sacs.—In their researches on cholera toxin, Metchnikoff, Roux and Salimbeni devised a method of growing organisms in small closed collodion sacs in the peritoneal cavities of animals.

By this method, organisms can be cultivated in the body, and at the same time be protected from phagocytes. The thin walls of the collodion sacs, while allowing osmotic changes to take place which alter the composition of the medium in the sacs and permit the toxins secreted by the organisms to diffuse into the tissues of the animal, prevent cells (micro-organisms and phagocytes) passing through. This method has many applications in bacteriological work.

All the soluble products of micro-organic metabolism dialyse more or less through the walls of collodion sacs, but they do not pass through *in toto*. The collodion membrane does not act as a perfect filter, so that some toxins pass through only with difficulty and very slowly (Rodet and Guechoff). The immunizing substances seem to pass through first (Crendiropoulo and Ruffer).

(a) **Method of preparing collodion sacs.**—Have ready (1) a wide-mouthed bottle containing collodion, free from castor oil, and of a medium syrupy consistence, (2) some small glass tubes of 5–6 mm. internal diameter, (3) some small conical india-rubber plugs, (4) a test-tube carefully calibrated and not enlarged at its lower part, (5) some silk thread.

Collodion containing castor oil [*collodium flexile* B.P.] may be used instead of ordinary collodion but such sacs are not so transparent, though they are more elastic and stronger than the others.

1. Rotate the lower end of the test-tube regularly on the sloping surface of the collodion and prolong the contact according to the thickness which the layer of collodion is to have.

2. Remove the tube from the collodion and continue turning it between the fingers for about a minute. Then let the layer of collodion dry for a few minutes until it is of a semi-liquid consistence.

3. With a scalpel cut round the layer of collodion near its upper end and separate the sac from the tube, thus: Free the upper end of the sac with the thumb nail, turn it back like a glove finger and gradually peel it off. This must be done slowly. [Dipping in methylated spirit softens the collodion and makes it strip easily.]

4. Distend the sac by blowing into it. A sac may be made to hold from one to several cubic centimetres according to the particular requirements of the experiment.

5. Fit a piece of small glass tubing into the open end of the sac, fasten it on with several turns of silk thread and cover the silk with a little collodion. Fill the sac with water and suspend it by a thread in a bottle or test-tube containing a little water. Plug the vessel with wool. Place the india-rubber plugs in a flask plugged with wool and containing a little water. Sterilize at 115° C. in the autoclave.

All these manipulations are delicate and take a long time, and it will often be advantageous to use the collodion sacs which can now be bought in the shops.

6. Take each sac out of the bottle with a pair of sterile forceps and transfer it to a sterile dish covered with paper. Suck up the water out of the sac with a pipette and replace it with broth sown with the organism under investigation.

7. Close the opening of the tube with an india-rubber plug picked up with sterile forceps, and cut it off short close to the tube with a sterile scalpel. Dehydrate the plug in absolute alcohol and cover it with several layers of collodion.

Notes.—(i) Bertarelli has recommended a method which considerably simplifies that just described. In Bertarelli's method, the free end of the piece of glass tubing to which the sac is affixed is drawn out beforehand so that the free end is fine and

conical. After the sac has been sterilized the water is withdrawn with a syringe and the culture introduced. The pointed end is then sealed off in a small flame. Bertarelli further suggests using a solution of collodion in ether of the same consistence as is used for embedding, in place of collodion.

(ii) Phisalix has introduced a modification of the method of preparation by which much stronger sacs can be made, and the risk of breakage in the abdominal cavity thereby reduced.

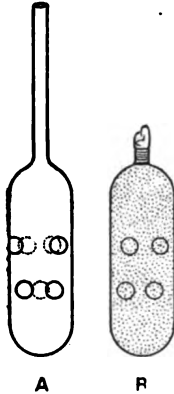

FIG. 141.—Phisalix' guides for collodion sacs.

A collodion sac is prepared as above (Stages 1 to 4) and slipped on to a guide consisting of a perforated glass ampoule (fig. 141, A). The sac which now covers the guide is fastened to the neck of the ampoule with a few turns of silk thread, and this is covered with a layer of collodion.

The sac is then sterilized in the autoclave in the ordinary way. After the sac has been filled with the culture the neck of the ampoule is sealed off in the flame (fig. 141, B).

(iii) Gorsline noted that the principal difficulty in making collodion sacs is the separation of the sac from the tube on which it is moulded. He overcomes this difficulty by using test-tubes perforated with a small hole in the bottom. In making a sac the hole is first obliterated by gently touching the bottom of the tube on the collodion. After the sac has then been made in the ordinary way and dried, the tube is filled with water. By blowing down the open end of the tube, the water forces its way through the small hole at the bottom of the tube and insinuates itself between the tube and the sac, with the result that the latter is easily separated.

(b) **Insertion into the peritoneal cavity.**—Collodion sacs may be used in experiments upon guinea-pigs, rabbits, dogs, sheep, cattle [and birds (fowls and pigeons)]. All these animals tolerate aseptic sacs filled with sterile broth very well. The technique of the operation is described above (p. 174, B).

After an interval varying from a few days to several months, the animal is killed and the sac withdrawn and its contents investigated. When the sac has been in the peritoneal cavity several weeks it not infrequently happens that it is found to be broken; [even then it is in the case of birds at least usually covered with a fibrous sheath which prevents dispersal of the contents]. It is well therefore to use several animals, to be sure of finding at least one sac intact. To remove the contents, sterilize the bottom with a hot wire, insert a pipette and aspirate the fluid.

D. Reed sacs.—Roux and Nocard suggested using, in place of collodion, a small piece of the tubular membrane lining the central canal of the bulrush. Sacs made with this membrane are more permeable than those made of collodion.

1. Take a few pieces of common bulrush and, if they are fresh boil them in water for about a quarter of an hour, but if dry autoclave them at 115° C. for an hour instead.

2. After softening them sharpen one end in the same way as a lead pencil, in order to expose the membrane lining the central canal. This membrane is then carefully denuded for a certain length.

3. Tie one end of the separated membrane firmly like a purse, then by pressing gently on this end with a glass rod it can be turned inside out.

4. Tie a small glass tube into the open end and fasten it with a stout ligature, and place another ligature on the sac itself below the end of the tube. Fill the sac with water and sterilize as in the case of collodion sacs.

5. Suck up the water out of the sac and replace it with the culture, tie the ligature on the reed and disconnect the sac from the tube above this ligature. Cover each ligature with a drop of melted gum lac.

Introduce into the peritoneal cavity in the manner already described.

(ix) Inoculation into the biliary passages.

In all animals in common use for experimental purposes the bile is poured into the duodenum through a simple channel—the bile duct—of which the orifice is more or less close to the pylorus. In the dog the opening is 4–12 cm., in the rabbit about 1 cm., beyond the pylorus, and in the guinea-pig about the middle of the duodenum. The operation in the rabbit, guinea-pig and dog will be described. The strictest asepsis must be observed.

A. Guinea-pig. Rabbit.—1. Anæsthetize the animal and fasten it on its back. Shave the hair and cleanse the skin of the abdomen.

2. Make an incision about 6 cm. long in the middle line commencing about 1 cm. below the xiphoid cartilage. Cut through the skin and aponeurosis, stop any bleeding, then incise the peritoneum on a director.

3. Identify the pyloric end of the stomach, then, using the index finger, find the duodenum and bring it to the surface. The opening of the bile duct will be seen about its centre.

4. Having identified the canal, isolate and fix it on a blunt hook. Pass the end of a fine needle bent at a right angle very obliquely through the wall and in the line of its long axis. Inject the material.

5. Withdraw the needle, and touch the point where it penetrated the wall with a sponge soaked in carbolic water. Stitch up the aponeurosis with silk, suture the skin and paint the incision with collodion.

B. Dog.—1. Anæsthetize the animal and fix it on its back. Shave the hair and cleanse the skin of the abdomen.

2. Make a longitudinal incision in the middle line, or a little to the right, about 8 cm. long, commencing a few centimetres below the xiphoid cartilage. Cut through the skin and aponeurotic layer, and stop any hæmorrhage. Incise the peritoneum on a director.

3. With the first finger in the wound, follow the lower surface of the liver, then bend the finger to hook up the duodenum and bring the latter to the surface, and to the left.

4. Find the right edge of the duodenum, and follow it until the finger meets the fold of the lesser omentum in which the bile duct lies with the portal vein, hepatic artery and nerves. The duct lies superficially in the fold and can be recognized by its pearly appearance, its structure, its direction, and by the fact of its opening into the duodenum at a distance of from 4 to 12 cm. beyond the pylorus.

5. Isolate the duct on a small director and fix it in a blunt hook. Pass the bent needle very obliquely through the wall in the line of its long axis. Inject the material, and complete the operation as above.

(x) Inoculation into the portal vein.

The operation is easier in the dog, but can also be done, though with some difficulty, in the guinea-pig and rabbit. The walls of the vein are very thin, and easily torn. The technique described above for finding the bile duct is applicable to the isolation of the portal vein in the dog. It is better to operate as follows :

1. Anæsthetize the animal, and fix it on its left side. Shave and cleanse the skin of the part.

2. Make an oblique incision in the right hypochondrium commencing above at the junction of the last rib with the vertebral column and extending to the outer edge of the rectus muscle at the crest of the ileum. Cut through

the skin and muscular layers. Stop the hæmorrhage. Incise the peritoneum on a director.

3. Get an assistant to pass his fingers into the wound and push the intestines to the left as far as possible and hold them in the abdomen.

4. Deep down, in the upper part of the wound below the liver the bend of the duodenum will be seen, and, on a level with it, the principal mesenteric veins converging above towards the portal vein.

5. Having recognized the vein, isolate it, fix it and perforate the wall with a bent needle. Inject the material.

6. Withdraw the needle and wipe the puncture in the vein with a sponge soaked in carbolic water. Put in two layers of sutures and cover the skin incision with collodion.

(xi) Inoculation into the kidneys.

The dog, rabbit, guinea-pig, etc., may be used for this experiment.

1. Lay the animal on the side opposite to that on which it is proposed to operate, and anæsthetize it. Shave and cleanse the skin over the region to be operated upon.

2. Make an incision outside the sacro-lumbar muscles from the anterior end of the last rib to the sacrum.

3. Incise the muscles for the whole length of the skin incision on a level with the external border of the floor of the lumbar region.

4. Retract the margins of the wound widely and the peri-renal adipose tissue will be exposed behind the peritoneum. Then, after tearing through the loose cellular adipose tissue with a director, the kidney appears in the wound.

5. Push the needle into the renal parenchyma and make the injection. Withdraw the needle and touch the needle prick with a sponge soaked in carbolic water. Insert two sets of sutures, and paint the skin incision with collodion.

Ureter.—The ureter can be exposed by operating in the same way. When the kidney is freed from the peri-renal adipose tissue the ureter will be seen lying with the renal vessels and nerves.

(xii) Inoculation into the anterior chamber of the eye.

A. Liquids.—1. Fix the animal on its belly, and fasten the head so that the animal cannot move it. It is well to anæsthetize the eye by dropping into it a few drops of a 1·5 per cent. solution of cocaine. In about 5 minutes the eye is completely insensitve.

2. Hold the eyelids apart and fix the eye with the thumb and index finger of the left hand. Insert the needle perpendicularly to the axis of the eye at the margin of the cornea at the corneo-sclerotic junction. Inject a few drops of the fluid and withdraw the needle.

B. Solid.—1. As in "A" above.

2. Then, the eyelids being held apart and the eye fixed make an incision a few millimetres long along the upper border of the cornea with a cataract knife or very fine scalpel.

3. Holding the tissue to be inoculated with a fine pair of bent forceps pass it through the incision and force it as far as possible into the anterior chamber by rubbing the cornea lightly with a Daviel's curette or the blunt end of a probe.

Inoculations into the anterior chamber are generally done on rabbits and are practised chiefly for infecting with hydrophobia or syphilis, or for studying the development of tuberculosis or the phenomena of phagocytosis.

(xiii) Inoculation into the respiratory passages.

A. Inoculation into the lungs.—1. Shave and cleanse the skin of the thorax in the neighbourhood of the axillary fold.

2. Push the needle perpendicularly through one of the upper intercostal spaces to a depth of from one to several centimetres, according to the size of the animal. Inoculate the material and withdraw the needle.

B. Intra-tracheal inoculations (*mammalia*).—1. Fix the animal on its back with the head extended and the neck raised by means of a firm plug of cotton-wool, a large india-rubber cork or a small block, etc. Shave and cleanse the skin in the middle line below the larynx.

2. Make an incision 2–3 cm. long through the skin in the middle line of the neck in front of the trachea.

3. Incise the aponeurosis on a director.

4. Having exposed the trachea, pass the needle obliquely into the lumen between two of the cartilaginous rings. Inject the material. Withdraw the needle and wash the perforation with a sponge soaked in carbolic water.

Notes.—(a) In small animals it is convenient as soon as the trachea is exposed to fix it by passing a suture needle threaded with silk through it.

(b) To avoid all risk of inoculating the material into the cellular tissue or into the walls of the trachea itself the following precautions may be taken. Use a small, very fine trocar with a cannula which should be shorter than the syringe needle. When the trachea is exposed pass the cannula between two of the cartilaginous rings, withdraw the trocar leaving the cannula in position. Pass the syringe needle through the cannula so that the point of the needle passes beyond the end of the latter. Make the injection and withdraw the needle first, then the cannula.

5. Suture the skin. Cover the wound with collodion.

C. Intra-tracheal inoculation in birds.—The opening of the trachea is behind the base of the tongue.

1. Open the beak and draw the tongue forwards with a pair of forceps.

2. The opening of the trachea will be seen behind the tongue and the material to be inoculated is injected straight into it.

D. Intra-pleural inoculation.—Besson has shown as a result of some observations which he made with Pourrat that it is a very difficult matter to inoculate a fluid into the pleural cavity without, at the same time, injuring and penetrating the lung. Consequently intra-pleural inoculation is not very exact.

In those cases where the syringe needle is passed obliquely from below upwards through an intercostal space (6th or 7th) it often happens either that the pleural cavity has not been reached or that the needle has passed beyond it. To perform a true intra-pleural inoculation the following technique must be followed.

1. After fixing the animal on its left side, shave and cleanse the skin over the middle of the right side of the thorax.

2. Make an incision about 3 cm. long through the sixth space about its centre parallel to the rib and passing through the skin, subcutaneous cellular tissue and, if desired, the external intercostal muscle.

3. Have ready a blunt-pointed needle, laterally perforated and previously sterilized and connected to a syringe by means of an india-rubber tube (p. 167). Pass the needle into the intercostal space, directing it somewhat obliquely. The parietal pleura attached to the outer wall of the cavity allows the needle to pass through: the visceral pleura, with the lung, is driven back by the blunt end of the needle and when the latter has gone a

distance of from a few millimetres to 2 cm. according to the species of animal used, the operator can feel that it is moving freely in a cavity. At this stage the fluid is inoculated.

4. Withdraw the needle quickly. Stitch up the skin and paint the wound with collodion.

E. Inhalation.—1. Put the animal in a solid-walled metal cage having an observation window on one side and on the other two holes lightly plugged with cotton-wool to allow of interchange of air: the tube from the pulverizer passes through a third hole.

2. Liquid cultures may be pulverized by means of Richardson's apparatus, but when the virus can be used dry without losing its virulence it is better to pour the liquid culture on to lycoperdon spores, lycopodium powder, or on to wood charcoal reduced to an impalpable powder. The culture is intimately mixed with the powder and then dried *in vacuo* over concentrated sulphuric acid. The powder well dried is then pulverized in the cage with a pair of bellows.

Note.—When dealing with micro-organisms pathogenic for man, the operator should be particularly careful to protect himself from the dust, and the experiment should be done, for choice, in the open air.

(xiv) Intra-cranial inoculation.

Intra-cranial inoculation is generally performed on the dog, guinea-pig or rabbit.

A.—1. Fasten the animal on its belly, the head being firmly held by an assistant.

2. Shave and cleanse the scalp behind the orbits.

3. Make an incision through the skin and aponeurosis about 3 cm. long in the middle line, commencing at a point level with the upper borders of the orbits. Retract the edges of the incision with a speculum. In the dog the incision is made preferably a few millimetres from the middle line to avoid the superior longitudinal sinus.

4. Place a small trephine about 5 millimetres in diameter (fig. 142) on the skull towards the middle of the incision and a little outside the middle line.

Commence trephining and when the teeth bite raise the axis to prevent wounding the brain.

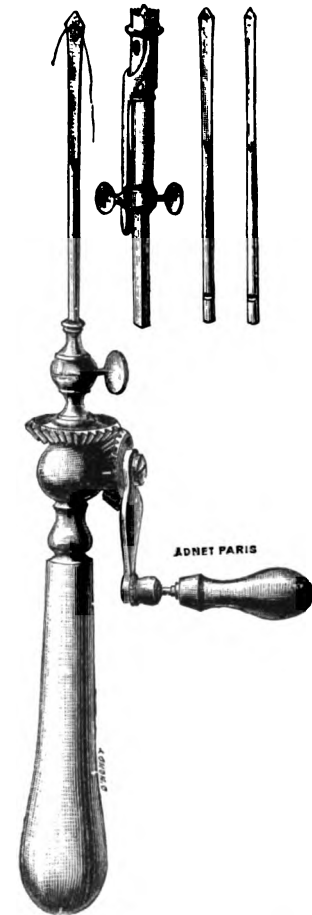

FIG. 142.—Trephine for small animals.

Ascertain frequently to what depth the trephine has reached and when resistance has ceased raise the circle of bone with a pair of forceps or small elevator.

5. The dura mater is now visible at the bottom of the wound. Pass the needle very obliquely through the meninges so that the brain may not be injured, and inject the fluid. It is well to use a needle bent to a right angle at the middle point of its length.

6. Withdraw the needle, touch the puncture with a sponge soaked in carbolic water, suture the skin and apply collodion to the incision.

B.—In injecting small doses of toxin into the cerebral tissues the foregoing technique may be simplified.

After shaving, cleansing and incising the skin make a small hole in the skull with a drill, limiting the depth of the perforation with a shield to avoid damaging the meninges. Then the needle is introduced to the required depth (determined beforehand by means of a probe) the toxin injected, the puncture touched with carbolic and a stitch put through the skin and covered with collodion.

(xv) Intra-spinal inoculation.

Intra-spinal inoculation is effected through the posterior occipito-atloid ligament. With a little practice it is easy to inoculate directly into the spinal canal of a rabbit or dog by forcing a curved needle into the ligament through the skin (which must have been previously cleansed): the needle passes behind the posterior occipital tuberosity just outside the middle line and is then turned and made to follow the occipital bone. Before injecting make sure that the needle has passed well into the canal by aspirating a little of the cerebro-spinal fluid into the syringe (which should be not quite full of the material to be injected). The inoculation must be done very slowly.

It is easier, especially in the guinea-pig, to fix the animal on its belly with the head flexed, then to divide the posterior cervical muscles transversely on a very small director below the posterior occipital tuberosity, avoiding the vertebral veins. When the muscles are divided the ligament will be seen and will be recognized by its pearly-white appearance. Bleeding is easily arrested by plugging the wound with wool soaked in a solution of peroxide of hydrogen. By keeping close to the lower surface of the occipital bone the membrane is easily pierced with a curved needle. After inoculating insert two sets of sutures and paint the wound with collodion.

(xvi) Inoculation into the alimentary canal.

A. Ingestion.—(a) The simplest method is to mix the culture with the animal's food, viz. bran in the case of rabbits and guinea-pigs and meal in the case of dogs.

(b) In small animals the culture may be sucked up into a Pasteur pipette which is then introduced into the animal's mouth, and the liquid allowed to fall drop by drop while the head is held up. The end of the pipette should be short and stout.

[In the experiments of the Royal Commission on Tuberculosis (1901) it was found that pipette-feeding experiments with liquids were unsatisfactory. The animal may cough or choke, and the fluid find its way to the lungs. Even when the fluid appeared to be swallowed quite satisfactorily disease of the lungs was sometimes found which could not have been of intestinal origin. Experiments conducted on these lines are likely, therefore, to lead to erroneous conclusions.]

(c) In the case of birds make small pellets of flour and mix the culture with it. Put a pellet on the base of the tongue and close the beak.

B. Oesophageal catheterization.—This method is more certain than the foregoing and moreover the amount of liquid injected can be measured.

Guinea-pigs and rabbits.—The animal with the head moderately extended is held by an assistant. By pressing the cheeks near the molar teeth the mouth can be opened and a small gag with a hole in the centre, or, better, a piece of iron wire bent into a rectangle, can be placed between the jaws behind

the incisor teeth (fig. 143). A very fine gum-elastic catheter can then be easily passed through the hole in the gag into the stomach. By attaching the needle of the syringe to the open end of the catheter, the fluid can be injected.

Dogs.—Fix the animal on its back, and gag it as described at p. 163. Pass a small cesophageal sound or a rather firm piece of ordinary india-rubber tubing of the size of an ordinary pen-holder into the stomach. Inoculate the culture through the sound or tubing.

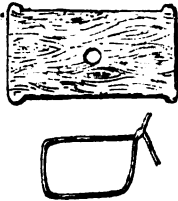

FIG. 143.—Gag for cesophageal catheterization.

It is often necessary to render the contents of the stomach alkaline before introducing the culture; this can be done by injecting 1 or 2 grams of sodium bicarbonate dissolved in a little water.

C. Inoculation into the intestines.—1. Open the abdomen as described on p. 174.

2. Pick up and hold a loop of intestine with a pair of forceps.

3. Pierce the wall of the loop obliquely with the syringe needle. Inject the material and withdraw the needle at once.

4. Dab the loop with a sponge soaked in carbolic solution: suture the aponeurosis and then the skin. Paint with collodion.

D. Rectal injection.—The animal must be firmly held by an assistant, then with a stout blunt-pointed needle inject the fluid into the rectum.

SECTION VI.—OBSERVATIONS TO BE MADE ON INOCULATED ANIMALS.

In studying an experimentally-induced disease the symptoms to which it gives rise in the inoculated animal should be observed and recorded day by day.

A note should be made of the following points:

1. **The local lesion.**—The presence or absence of a local lesion. The time when it appears. Its situation, extent, nature and the changes which it undergoes. Enlargement of the glands.

2. **Temperature.**—The temperature should be taken at least twice a day in the rectum, with a thermometer graduated in tenths of a degree centigrade and of a size suitable to the species of animal under observation. The temperature must always be taken before inoculating the animal. It is necessary to bear in mind that all animals have not the same normal temperature; in guinea-pigs, rabbits, goats, pigs and cattle¹ the normal temperature varies from 38.5° to 39.5° C., that of horses and asses between 38° and 39° C. and of birds between 41° and 42° C. In small animals, complete immobilization rapidly reduces the temperature which should therefore never be taken with the animal tied to the operating table. A curve of the temperature should be kept.

3. **Weight.**—Animals must always be weighed before inoculation. A ratio can then be established between the weight of the animal and the quantity of virus which must be inoculated in order to produce sickness or lead to death. In chronic conditions, the animal should be weighed from time

[¹The normal temperature of an adult bovine animal is usually constant in the neighbourhood of 38.5° C.; that of a young calf may vary from 38.9° C. to 40.0° C. with a mean of 39.2°–39.4° C.]

to time: the weight curve furnishes valuable information as to the course of the disease.

4. Auscultation.—The development of pulmonary lesions can be detected and followed by auscultation.

5. Condition of the alimentary canal.—Observation should be kept upon the animal's appetite and it is highly important to notice if it suffers from diarrhoea, etc.

6. Urine.—Does the urine contain pus, blood albumin, etc. ?

7. The appearance of the animal.—Whether the animal is lively and active or dull and quiet, the condition of its coat whether rough and badly kept or smooth and well tended, as well as the position assumed by the animal (whether lying on its side or curled up) are all important facts which should be noted. The appearance of twitchings, convulsions or signs of paralysis should also be carefully watched for.

Observation of the clinical condition must be subsequently supplemented by an examination of the tissues, fluids and exudates for micro-organisms.

CHAPTER XI.

POST MORTEM EXAMINATIONS.

Introduction.

1. Instruments, p. 184.
2. Preliminary operations, p. 185.
3. Examination of the external surface of the carcass, p. 185.
4. Examination of the internal organs, p. 185.
5. Removal of tissues for histological examination, p. 188.

THE objects of *post mortem* examination are two in number.

1. To ascertain as far as possible the nature of the lesions which were the cause of death.

2. To collect material for further investigation. This will involve the search for micro-organisms in the blood, exudates and internal organs by microscopical, cultural and inoculation methods, as well as the histological examination of portions of the internal organs. The material therefore will have to be collected under very strict aseptic precautions.

The following **general rules** must be observed in conducting a *post mortem* examination on small animals.

A. To avoid soiling the bench fasten the animal to a sheet of zinc or copper [or pin it by the paws to a sheet of cork or a wooden board covered with cork linoleum, either of which can be washed with antiseptics, preferably 2 per cent. lysol, before and after use]. Lay all the instruments in use on the metal tray [or wooden board] and not on the bench while the examination is in progress.

B. Use sterile forceps and not the fingers for raising the skin, muscles and internal organs.

C. Sterile instruments must be used throughout.

D. Conduct the examination at the earliest moment possible after the death of the animal.

E. As soon as the examination is completed burn the carcass and any wool or paper which may have been used in an incinerator (fig. 13, p. 16) or in a fire with a good draught, boil the instruments, and if a metal tray has been used immerse it in a vessel of boiling water if it is not too large, or wash it with a strong solution of lysol or carbolic acid.

1. Instruments.

Have ready before commencing a *post mortem* examination—

1. Sterile scalpels, bistouries, dissecting forceps and scissors both large and small.
2. A number of sterile Pasteur pipettes.

3. Two or three platinum wires one of which should be stout and flattened at the end in the form of a small spatula.

4. An iron rod of the size of a large goose-quill and 15–20 cm. long, mounted in a wooden handle.

5. A tray of zinc or copper or a sheet of cork.

6. Sterile absorbent wool in a glass bottle plugged with wool and some sterile filter paper.

Cut a sheet of filter paper into pieces about 10 cm. square, wrap them in a piece of ordinary paper and sterilize the packet in the autoclave.

7. An enamelled iron bowl or glass dish containing an antiseptic solution (0.01 per cent. corrosive sublimate, or oxycyanide of mercury [or 2 per cent. lysol]).

8. A Bunsen burner or a spirit lamp.

9. Tubes of agar, broth, etc.

10. [Slides and cover-glasses.]

11. Wide-mouthed, glass-stoppered bottles of 30–50 c.c. capacity.

2. Preliminary operations.

1. Fasten the animal securely to the tray. In the case of rabbits, guinea-pigs, cats, etc., lay them on the back, pass a slip knot round each paw and tie to holes in the sides of the tray [or if a wooden board be used pin the animal's extended paws to it with large drawing pins].

Frogs, mice, sparrows, etc., can be pinned down on their backs to the cork sheet, one pin being passed through the neck the others through the extended paws or wings.

In the case of fowls and pigeons cut off the wings, lay the animal on its back and fasten the neck and legs by cords passed through holes in the sides of the tray.

2. The animal being fastened out, thoroughly wet the surface of the thorax and abdomen with the antiseptic and cut off the hair gathering up the loose hair in a piece of paper which is then burnt. Never cut off the hair without first of all wetting it.

In the case of birds the same precaution must be adopted before plucking the feathers.

3. Examination of the external surface of the carcass.

Before opening the carcass, examine the external surface carefully for lesions of the skin, abscesses, etc. If an abscess be found, cut away the hair, cauterize the surface thoroughly with a red-hot iron rod, flame and break off the point of a Pasteur pipette as quickly as possible, push the pipette through the centre of the cauterized area and aspirate the pus through the plugged end.

If the pus be thick and inspissated—as it often is in the case of rabbits—and cannot be drawn into the pipette, make an incision with a sterile knife after cauterizing the skin and collect the contents either on the point of the knife or with a stout platinum wire.

After sowing two or three tubes of culture media with some of the material prepare films for microscopical examination.

4. Examination of the internal organs.

As a rule it is better to open the thorax first. If the abdomen were opened before the thorax it might happen that contamination of the thoracic organs could not be prevented.

A. Mammalia.

1. Pick up the skin over the manubrium sterni, incise it and prolong the incision to the lower part of the abdomen, then extend the incision outwards to the roots of the four limbs. Dissect the skin from the subjacent tissues and throw the flaps outwards. This incision must involve the skin only.

2. Should there be reason to suspect the presence of excess of fluid in the pleural cavities, cauterize the muscles over one of the intercostal spaces,

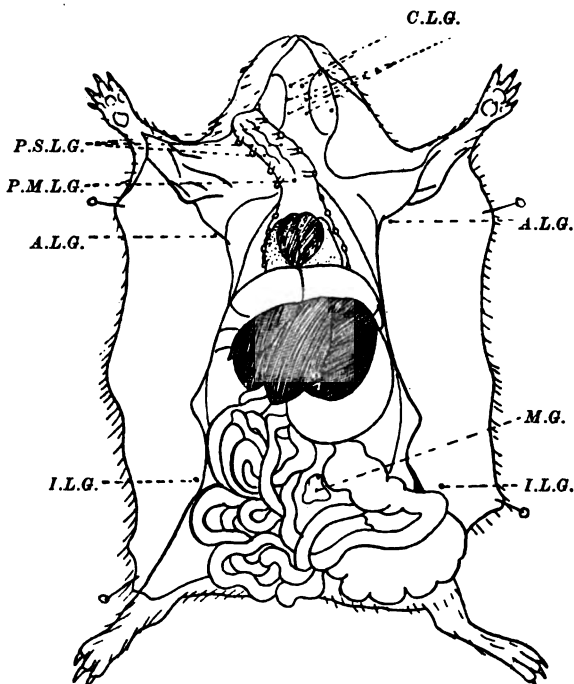

FIG. 144.—Appearance presented by a normal guinea-pig.

C.L.G. Cervical lymphatic glands; *A.L.G.* Axillary lymphatic glands; *M.G.* Mesenteric gland; *I.L.G.* Inguinal lymphatic glands; *P.M.L.G.* Post-manubrial lymphatic gland; *P.S.L.G.* Post-sternal lymphatic glands.

introduce the point of a flamed pipette, aspirate some of the fluid, sow cultures and make films. $\frac{2}{3}$ 100

3. To open the thorax. Raise the tip of the xiphoid cartilage with a pair of sterile forceps, introduce the point of a pair of strong scissors beneath the costal cartilages a little to one side of the sternum, and inclining the scissors slightly outwards cut through the costal cartilages as far as the clavicle and then divide the clavicle. By doing the same on the other side of the sternum a flap is formed which can either be turned upwards or detached. This will expose the heart and lungs.

4. If there be any fluid in the pericardium, take hold of the latter with a pair of sterile forceps, flame the point of a pipette and push it through the membrane close to the forceps. The hot end of the pipette will sterilize the surface of the pericardium as it passes through it. Aspirate the fluid.

5. To collect blood from the heart, tear through the pericardium with two pairs of forceps, or holding it with a pair of forceps slit it up with a pair

of fine scissors. Cauterize the surface of the ventricle with a red-hot rod, pass a pipette through the sterilized area and aspirate the blood.

6. To collect material from an hepatized or congested area of the lung, cauterize the surface of the latter and pass a pipette or the bent end of a stout platinum wire into the affected part : or the latter may be exposed by taking hold of the lung with two pairs of sterile forceps and tearing it.

7. When the examination of the thorax is completed, open the abdomen.

To collect the peritoneal fluid lift up the muscular wall with a pair of forceps, make a small slit with a sterile scalpel, introduce a pipette through the opening and aspirate the fluid from the flanks. The pipette should be held parallel to the abdominal wall so as to avoid damaging the intestine.

Complete the incision of the abdominal wall along the middle line and throw the flaps outwards.

8. Note carefully the appearances presented by the internal organs. In taking material from the liver, spleen, kidneys or lymphatic glands, first cauterize the surface, then pass a stout wire bent in the form of a hook through the centre of the cauterized area deeply into the organ, twist it round and round and on withdrawing it sow the material at once on a suitable culture medium. For making films, simply tear off a small piece of the organ with a pair of forceps (Chap. XIII.).

To examine the intestinal contents, cauterize the surface, pass a pipette through the cauterized area and aspirate some of the contents. Urine may be collected from the bladder in a similar manner, a ligature being first tied round the urethra.

9. *Bone marrow*.—To examine the bone marrow expose one of the long bones, divide it across with a pair of strong sterile scissors and collect the medulla in a pipette or platinum loop.

If the bone be divided with non-sterilized scissors the cut end must be cauterized with a heated iron rod before aspirating the medulla.

10. *Examination of the central nervous system*.—Lay the body on its ventral surface and fasten the feet firmly to the tray [or board] as before.

Make an incision through the skin from the root of the nose to the sacrum along the line of the spinous processes of the vertebræ, and reflect the skin ; detach the scapulæ at their humeral articulations and turn them on one side ; then dissect away the masses of muscle from the vertebral laminæ with a strong bistoury, taking care in so doing not to penetrate the abdominal cavity in the lumbar region. With a pair of curved Liston's forceps (fig. 145)

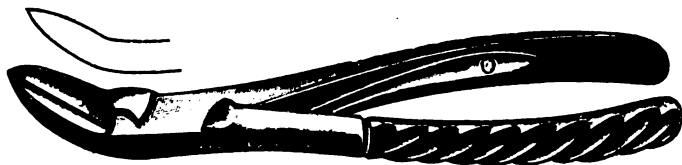

FIG. 145.—Curved Liston's forceps.

open the skull along an horizontal line passing through the superciliary ridges ; free these ridges on each side by an oblique incision ; then raise the frontal bone with an elevator and detach it with the Liston's forceps. This will expose the brain. Having reached the occipital foramen raise the spinous processes with the elevator and cut through the laminæ of the bodies of the vertebræ with the forceps alternately on the right and left sides. This if properly done (a certain amount of skill and patience is required to avoid

injury to the spinal cord) will remove the spinous processes in the form of a rosary held together by the ligamenta flava.

If there is any meningeal exudate, cauterize the surface of the membrane, introduce a pipette through the centre of the cauterized area and aspirate the fluid.

To remove portions of the nerve tissue tear through the meninges with two pairs of forceps, cauterize the area (cerebrum, cerebellum, medulla oblongata or spinal cord), and push the point of a strong pipette deeply into the tissue; then aspirate the material, twisting the pipette about if necessary. Or, after cauterization, portions of tissue may be removed with a platinum loop or with a sterile bistoury.

B. Birds.

To open the thorax in birds it is best to divide the skin along the middle line, and after reflecting it to each side to make a curved incision, extending to the bone, round the sternum; beginning at the root of the neck, continue along the right margin, round its lower end and up the left margin. Cut through the clavicle on each side with a pair of stout scissors, and following the line of the incision through the soft parts detach the sternum from the ribs, then cut away the muscular attachments and remove the breast plate.

The examination will then be proceeded with as in the former case.

C. Post-mortem examination of human bodies.

The technique to be employed in the collection of material *post mortem* from the human subject does not differ from that already described in the case of animals, and the methods of examination should also be the same, but it must be remembered that if the results of the bacteriological investigation are to be relied upon the examination must be made within a few hours of death; if it be delayed until the interval required by law has elapsed (24 hours after death) the bacteriological findings must be accepted with caution especially in summer; the presence of the colon bacillus in particular in the internal organs would be under such circumstances without significance, since this organism multiplies in the tissues of the body immediately after death and sometimes even during the period immediately preceding death.

Note.—The material collected *post mortem* may either be examined and sown at once, or may be put aside for examination at a later stage, provided that both ends of the pipettes containing the material be sealed. In the latter case to reach the contents of a pipette, push down the wool plug almost as far as the top of the fluid, and cut off the part of the pipette above it with a glass-cutter and a point of red hot glass; the plug can then be taken out and the contents manipulated with a pipette just as in the case of a culture-tube.

5. Removal of tissues for histological examination.

For purposes of subsequent histological examination, small pieces of the internal organs [and other tissues] should be removed at the time of the *post mortem* examination. The pieces should be quite small (cubes of 10–15 mm.), but should be cut off with a sharp sterile bistoury so that the section may be as clean as possible. Place the pieces at once in ground-glass stoppered bottles containing one of the following fixing solutions:

1. **Absolute alcohol.**—For bacteriological purposes absolute alcohol is the simplest and the most generally useful fixative.

The method of placing the tissue in the first instance in weak alcohol and

subsequently transferring to solutions of increasing strength not only takes more time but yields only moderate results.

To fix in alcohol, place the tissue (about 1 cm. cube) in 25–30 c.c. of absolute alcohol: renew the alcohol after 3 hours and again after 24 hours. The tissue is then fixed, but it is found to stain better if left in the alcohol for 3 days. Tissues should not under any circumstances remain in absolute alcohol for more than a week at the outside, and if it is not convenient to use them then they should be transferred to 90 per cent. alcohol.

The tissue should be suspended in the fluid or laid on a piece of wool at the bottom of the bottle to ensure its hardening uniformly.

2. Formalin.—Formalin is an excellent hardening agent; it does not interfere with any of the staining methods and is particularly valuable for tissues which are to be cut by the freezing process. The best solution is the following:

| | |
|--------------------------------|---------|
| Commercial formalin, | 10 c.c. |
| Distilled water, | 90 " |

The tissue is fixed in about 6–8 hours; but better preparations are obtained if the formalin is allowed to act for 24–48 hours.

If frozen sections are to be cut the tissue is used straight out of the formalin: but before embedding in paraffin, transfer the tissue first to 90 per cent. alcohol, then to absolute alcohol, leaving it for 24 hours in each solution.

3. Corrosive sublimate.—Corrosive sublimate is another most useful hardening agent, and can be used whatever method of staining is to be subsequently employed. It can be used as a cold saturated solution¹ but it penetrates and fixes the tissue better when acidified with acetic acid.

Acid sublimate (Mayer).

| | |
|--|------------|
| Saturated aqueous solution of corrosive sublimate, | 100 parts. |
| Glacial acetic acid, | 1–3 " |

Allow 20–30 c.c. for each piece of tissue. The solution penetrates well and rapidly, so that the pieces may be relatively large (cubes of 2 cm.). Leave in the acid solution for at the most 12 hours. The tissue is then white and opaque. Wash in running water for an hour (this is not absolutely essential). Transfer to 100 c.c. of 70 per cent. alcohol containing xv–xx drops of tincture of iodine and leave for 24 hours to remove the excess of perchloride and prevent the deposition of crystals in the tissue. Transfer to 80 per cent. alcohol for 24 hours and finally to 90 per cent. alcohol for a similar period.

It must be remembered of course that perchloride of mercury acts on metal instruments, so that in removing tissues from perchloride solutions horn, glass or wood spatulas must be used.

4. Flemming's solution.—For purposes of bacteriological examination the diluted solution is better than the concentrated.

(a) Diluted solution.

| | |
|---|-------------|
| 1 per cent. aqueous solution of chromic acid, | 25 volumes. |
| 1 per cent. " " osmic acid, | 10 " |
| 1 per cent. " " acetic acid, | 10 " |
| Distilled water, | 55 " |

(b) Strong solution.

| | |
|---|-------------|
| 1 per cent. aqueous solution of chromic acid, | 15 volumes. |
| 2 per cent. " " osmic acid, | 4 " |
| Glacial acetic acid, | 1 volume. |

¹Cold water dissolves about 6.6 per cent. of perchloride of mercury. A saturated solution is easily prepared by dissolving 70 to 75 grams of perchloride in 1 litre of distilled water in the warm: filter while warm, and, as the solution cools, white needles crystallize out at the bottom of the vessel; pour off the supernatant liquid which is then ready for use.

These solutions ought to be prepared just before use. The use of Flemming's solution should be limited to the hardening of nerve tissues, and the pieces should be very small. Many stains cannot be used after Flemming's solution; the best to use are hæmatoxylin, safranin and the basic aniline dyes.

Suspend the tissue in the solution and leave it for 36-72 hours (weak solution) or 1-24 hours (strong solution), wash in running water for 24 hours, transfer to distilled water for 1 hour, and then for 24 hours to each of the following solutions successively, viz. 70 per cent., 80 per cent., 90 per cent. alcohol.

5. Flemming-perchloride solution.—A mixture of acid perchloride and Flemming's solution combines the advantages of both. The mixture is prepared according to the following formula :

| | | | |
|---|---|---|----------|
| Saturated aqueous solution of perchloride of mercury, | - | - | 500 c.c. |
| 1 per cent. aqueous solution of chromic acid, | - | - | 500 " |
| Osmic acid crystals | - | - | 1 gram. |
| Glacial acetic acid, | - | - | 50 c.c. |

Harden for 12-24 hours. Wash and transfer to alcohol as in the case of Flemming's solution.

CHAPTER XII.

THE COLLECTION OF MATERIAL FOR BACTERIOLOGICAL EXAMINATION.

1. Hair, p. 191.
2. Skin, p. 191.
3. Sputum, p. 191.
4. Blood, p. 192; collection of serum, p. 196.
5. Pharyngeal exudates, p. 197.
6. Abscesses, p. 197.
7. Aqueous humour, p. 197.
8. Pleural and pulmonary exudates, p. 198.
9. Ascitic fluid, p. 198.
10. Tumours and lymphatic glands, p. 198.
11. Splenic puncture and splenectomy, p. 198.
12. Lumbar puncture, p. 199.
13. Milk, p. 201.
14. Urine, p. 201.
15. Stools, p. 202.

1. Hair.

Man and animals.

Pull out a few hairs with a pair of sterile forceps, lay them between two sterile microscope slides and wrap up the slides in a piece of sterile paper. They can thus be put aside or be transmitted to the laboratory without fear of contamination.

2. Skin.

Man and animals.

1. Cut off the hair with a pair of sharp scissors.

2. Scrub with a nail brush and soap, wash with boiled water and rub briskly with a sponge wrung out in a 1 in 1000 solution of sublimate, wash with absolute alcohol, then with ether and wipe quickly with a piece of sterile filter paper.

3. Pick up a small fold of the skin with a pair of sterile forceps and cut it off through the base with a sharp-pointed sterile bistoury.

If the skin be thick or adherent to the deeper tissues it will be difficult to pick up a piece of the size required. In that case mark out a small rectangular area with the bistoury, detach one corner and then, taking hold of the latter with a pair of sterile forceps, dissect the piece of skin from the deeper tissues.

4. If the material be collected at the bed-side it can be taken to the laboratory between two sterile watch-glasses or in a sterile glass dish wrapped up in paper.

3. Sputum.

Man.

A. Ordinary method of collection.—For the ordinary microscopical examination of sputum for the tubercle bacillus, it will suffice if the patient cough the sputum into a sterile bottle or clean pocket handkerchief. The material should be examined as soon as possible.

B. Kitasato's method.—This method is much to be preferred when cultures are to be sown or investigations of a more delicate nature are to be made.

1. The patient rinses his mouth and gargles the back of his throat several times with boiled water and then coughs the sputum into a sterile Petri dish.

2. Transfer the sputum immediately to a tube containing several cubic centimetres of sterile water and shake it up well. Remove the sputum from the tube with a sterile platinum loop or a pair of sterile forceps to a second tube of sterile water and wash it in this way three or four times to free it, as far as possible, from contaminating organisms (but note that sputum can only be washed when it is tenacious and lumpy as in influenza, advanced tuberculosis (nummular sputum), etc.).

3. After washing spread the sputum in a thin layer in a sterile Petri dish and cut off a small fragment with a small pair of sterile scissors or platinum needle from as near the centre as possible. Use this for sowing cultures.



FIG. 146.—Wright's capsule for collecting blood.

4. Blood.

Man.

A. Pricking the skin.—A small quantity of blood is readily obtained by pricking the distal end of the finger near the nail and collecting the drops in some suitable sterile vessel such as a Pasteur pipette, a small tube [or a Wright's capsule] or on a glass slide. This method is however only applicable when the blood is required for immediate microscopical examination, *e.g.* for anthrax bacilli, hæmatozoa, etc., as it is liable to contamination during collection. When the blood is required for sowing cultures, it should be taken from a vein.

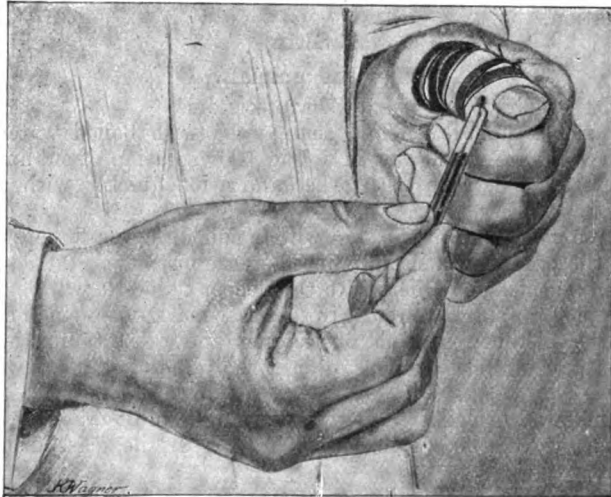

FIG. 147.—Method of collecting blood by pricking the finger.

1. Scrub the ball of the finger with soap and water. Wash it in perchloride, alcohol and ether. Dry with sterile paper.

2. Compress the base of the finger by grasping it with the left hand or by tying a ligature round it (fig. 147).

3. With a sterile pin or small lancet [or a straight surgical triangular needle] prick the skin sharply and deeply.

4. Wipe away the first drop or two of blood which issues with a piece of sterile paper and collect the remainder.

As a further precaution the skin of the finger after being washed and dried may be painted over with a very thin layer of collodion. The finger is then pricked through the collodion and in this way the blood is prevented from coming in contact with the skin.

B. Cupping.—A larger volume of blood can be obtained by cupping, but otherwise the method is open to the same objections as the foregoing.

1. Asepticize about 10 sq. cm. of the skin of the thorax, back or sides.

2. Apply a sterile cupping-glass over the part.

3. When the glass has fixed itself, raise it (the operator's hands having, of course, been already sterilized), scarify the skin with a sterile razor and apply the cupping-glass again.

4. When sufficient blood has collected put the patient in such a position that the blood will not be spilt, then lift the glass and cover it at once with sterile paper.

C. Bleeding from a vein at the bend of the elbow.—By this method all danger of contaminating the blood is avoided, and it should be adopted in all cases when cultures have to be sown. It is attended by no danger and is less painful than the foregoing methods.

1. Procure a sterilizable syringe of 2–20 c.c. capacity according to the amount of blood to be collected, and adjust a sharp and clean-bored needle. Test its efficiency and, if satisfactory, sterilize it with the needle attached, by boiling it in water for 15 minutes or by heating in the autoclave at 115° C.

2. Lay the patient's forearm flat on the bed, and get an assistant to compress the middle of the arm or put a tight bandage round it as in the operation for bleeding.

3. Wash the skin over the bend of the elbow with soap and rinse with sublimate or oxycyanide, then with alcohol and finally with ether. As the result of the combined compression and friction the veins at the bend of the elbow will stand out prominently.

To make certain of asepsis it is sometimes advised to lightly touch the point through which the needle is to be passed with a cautery; but in the great majority of cases it is sufficient to wash the arm in the manner described.

4. Select the largest vein, push the needle through the skin and then into the vein. The vein lying, as it does, immediately beneath the skin is generally penetrated at the same time as the skin. The needle should be held parallel to the long axis of the vein and at a very acute angle to the surface. When the vein is entered, by gently withdrawing the plunger, blood will flow into the syringe.

Notes.—There is nothing to be gained by pointing the needle towards the hand; on the contrary, it is easier to point it towards the arm and the calibre of the vein is such that it flows just as easily into the needle whichever way the latter is directed. The alternative method which consists in first making an incision through the skin and exposing the vein should never be practised.

5. When the syringe is full, withdraw the needle from the vein, relieve the pressure and apply a drop of collodion to the needle prick. Be careful not to let the blood clot in the syringe but squirt it at once into a sterile test-tube; then wash the syringe in cold water and sterilize it.

Horses, asses and cattle.

In these animals the jugular vein is the most convenient from which to bleed. The method has already been described in dealing with the

preparation of serum (p. 48). When a small quantity only of blood is wanted a syringe is used instead of a trocar.

Guinea-pigs.

Guinea-pigs may be bled from the jugular vein, from the femoral or carotid arteries, or by cardiac puncture.

A. From the jugular vein.—For the anatomical data see p. 172.

1. Fix the guinea-pig on its back with the head extended. Shave the skin over the front of the neck and cleanse it in the ordinary way.

2. Make an incision through the skin and sub-cutaneous tissue along the line of the vein, dissect away the cellular tissue with a director and the vein will come into view.

3. Pass the needle of a sterile syringe or the end of a pipette (similar to that described at p. 166) very obliquely into the vein. If a slip knot be passed under the vein with a Deschamps needle on the cardiac side of the puncture, the vessel can be compressed and the flow of blood into the pipette facilitated.

4. Having collected the blood, withdraw the needle or pipette and make certain that there is no hæmorrhage from the puncture. If the vein be bleeding, tie a ligature above and below the puncture. Put two or three stitches in the skin and cover the wound with collodion.

Note.—The blood may be collected directly in a sterile tube or flask by passing a fine trocar into the exposed vein. The operation in this case is described at p. 49.

B. Carotid and femoral arteries.—1. Expose the vessel (pp. 173 and 174).

2. Puncture the wall of the artery obliquely with a syringe needle, the end of a bent pipette or a small trocar.

3. Having collected the blood, withdraw the instrument, stitch up the skin and paint the incision with collodion.

Sometimes hæmorrhage occurs when the needle is taken out of the artery. This can be guarded against by placing two ligatures beneath the vessel, one above and the other below the puncture, then, if hæmorrhage occur, the two threads can be tied and the wounded part of the vessel isolated.

C. Cardiac puncture.—Cardiac puncture as practised in physiological laboratories may be usefully applied for bacteriological purposes (Pagniez). It allows a much larger volume of blood to be collected than is possible by other methods, is easily performed and is unattended by danger to the animal; moreover the blood is not exposed to any risk of contamination. The technique, which is as follows, has been worked out by Raybaud and Hawthorn.

1. Tie down the animal on its back, shave and cleanse the skin over the front of the cardiac area. Have ready a sterile syringe capable of holding 5 c.c. and fitted with a needle of the ordinary pattern but very sharp.

2. At a point on the left margin of the sternum, about 8–10 mm. above the angle formed by the base of the xiphoid cartilage and the last rib cartilage articulating with the sternum, push the needle sharply to a depth of 15–17 mm. above the last but one or last but two chondro-sternal articulations.

The needle will pass into the left ventricle, and by inclining it a little towards the middle line it can be made to enter the right ventricle. This method is to be recommended because the risk of wounding the anterior margin of the left lung is lessened, and if the heart were punctured at a higher level than that described the auricle would be penetrated and ruptured.

3. Fill the syringe slowly with blood, and withdraw the needle sharply and quickly.

Rabbits.

A. The ear veins.—The simplest method of collecting blood from a rabbit

is to take it from one of the veins of the ear. An adult rabbit can easily be bled to the extent of 20 c.c. in this way.

1. Prepare a large Pasteur pipette with the pointed end short but strong and bent at an obtuse angle to the shaft (fig. 133, p. 166). The point must be sharp and have thin cutting edges. Sterilize the pipette by passing it through the flame but be careful to allow it to cool before using it. In this particular case a pipette is better than a syringe.

2. Let the animal sit on the knees of the operator or of an assistant. Shave the hair over the line of the marginal vein and cleanse the skin in the ordinary way (p. 172). Compress the vein at the root of the ear between the finger and thumb or with a pair of pressure forceps.

3. Holding the ear in the left hand, thrust the point of the pipette through the skin and then into the lumen of the vein. A flow of blood into the pipette will indicate when the point is in the vein. The point of the pipette should be directed towards the tip of the ear and must be held absolutely parallel to the axis of the vein to avoid penetrating both walls.

The flow of blood into the pipette is slow: sometimes it ceases, owing to the formation of a small clot in the end of the pipette; this, however, can easily be displaced by aspirating at the plugged end of the pipette.

It is a good practice to puncture the vein near the root of the ear so that if unsuccessful at the first trial another attempt may be made nearer the tip. By bleeding from the two ears in turn, blood may be collected at frequent intervals from the same animal.

4. When sufficient blood is collected remove the pipette and seal the point in the flame. The blood can afterwards be aspirated into other Pasteur pipettes through the plugged end, the plug being well flamed before being taken out.

5. Clip the wound with a pair of pressure forceps for a moment to stop any hemorrhage. After being bled the animal will be thirsty, and some water should be left in its cage.

B. Jugular vein.—The anatomical data and the technique of the operation are the same as in the case of the guinea-pig (p. 194).

C. Carotid and femoral arteries.—Here again the description given for the guinea-pig is applicable (p. 194).

D. Cardiac puncture.—The technique is similar to that described for cardiac puncture in the guinea-pig. C. Nicolle and Duclaux recommend using a rather large needle, about 2 cm. long, fitted to a sterile syringe of 10–20 c.c. capacity.

1. The animal is held down on its back and the skin over the heart shaved and cleansed.

2. The needle with syringe attached is driven in sharply to a depth of 17–18 mm. to the left of the sternum in the fourth intercostal space counting upwards from the xiphoid cartilage. The needle must be inclined from below upwards and slightly inwards.

3. Aspirate the blood slowly into the syringe and then withdraw the needle quickly.

Dogs.

Dogs are most easily bled from the jugular or external saphenous vein (p. 173), or from the carotid or femoral artery, the ordinary rules of asepsis being observed. It is to be remembered that dogs' blood coagulates very quickly.

Birds.

Bled from the axillary vein (p. 173) adopting the ordinary aseptic precautions.

Collection of serum.

On account of the importance at present attaching to a study of serum reactions it is often necessary to collect serum from immunized animals.¹ In the case of large animals it is best to bleed by the method described on p. 49. Small animals may be bled preferably from the carotid by the method just described, and after the clot has contracted the serum can be decanted. But by this method much of the serum is lost, being retained in the meshes of the clot and it is better, therefore, when the amount of blood available is strictly limited as is the case with small animals, to bleed into a Latapie's tube. By using this apparatus all chance of contaminating the blood is avoided and a yield of 80 per cent. of the total volume of serum is assured.

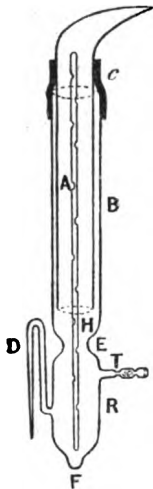

FIG. 148.—Latapie's apparatus for collecting blood from small animals.

Technique.—Place a few drops of water in the apparatus and sterilize it in the autoclave at 120° C. Expose the carotid in the ordinary way then break off the point of the tube A with a pair of sterile forceps and pass it into the vessel, holding the apparatus so that the broken point is downwards. Blood will now ascend into the tube A. Stop the flow of blood before the latter is quite full, then seal the pointed end of A in the flame, gently aspirating through T to prevent the blood being clotted by the heat. Stand the apparatus on one side with the tube A downwards. The clot forms around the narrow central tube H, and retracts from the walls of A. If the apparatus be now inverted the serum will fall into the collecting bulb R, the red cells precipitating into the cup F. In this way 80 per cent. of the serum can be collected in a few hours, and can be easily withdrawn through the tubulure D by breaking its point and blowing through T. With a little experience and skill a small animal such as a rabbit or guinea-pig can be bled two or three times without killing it.

Stassano's apparatus.—Stassano's apparatus is somewhat similar to Latapie's but is fragile and more expensive.

Lumiere's tube.—This consists of a glass tube (fig. 149) on which two bulbs B and D are blown, the interior of the lower B having a number of projecting points. The tube is plugged with wool at the ends and sterilized in the hot air sterilizer. To use the apparatus the tube A is fitted with a short piece of india-rubber tubing carrying a sterilized platinum-iridium syringe needle. As soon as the vessel is penetrated, blood will flow into the bulb B. When the latter is full, the tubing is pinched and the needle withdrawn from the vessel. The

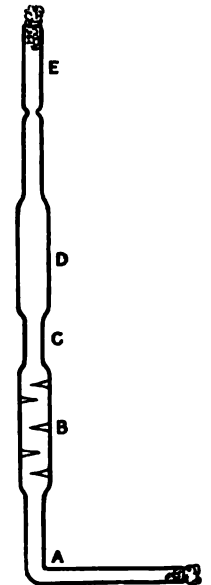

FIG. 149.—Lumiere's tube for collecting blood.

¹ The collection of serum for use as a culture medium is described in Chapter II.

tube A is then tilted, the india-rubber tubing detached, and after passing it through the flame the end A is plugged with wool. When the blood is clotted the apparatus is inverted, the clot will be held by the points in B and the serum will run into the bulb D.

Centrifuging.—The maximum yield of serum is obtained in the minimum of time by centrifuging the blood (Camus). Collect the blood, without contaminating it, in a number of sterile centrifuge tubes (*vide infra*), plug the tubes with wool and centrifuge at once. The serum collects in the upper part of the tube and the clot below. If the animal was fasting at the time of bleeding, the serum will be clear and transparent; on the other hand if digestion was going on the serum will be milky and slightly opaque.

5. Pharyngeal exudates.

Man.

A. Puncture of the tonsil.—1. Get the patient to clean the surface of the mucous membrane by thoroughly rinsing out his mouth with boiled water.

2. Make the patient sit up and incline his head at a suitable angle, then press the tongue down.

3. Take a rather long stout-pointed Pasteur pipette with a sharp cutting end, heat it well in the flame and then pass it rapidly and deeply into the tissue of the tonsil. The heated end cauterizes and sterilizes the surface of the gland and is itself cooled before reaching the deeper parts. Aspirate lightly through the plugged end of the pipette and then withdraw the instrument.

4. The small quantity of material which will be obtained should be sown at once into broth and the pipette washed out two or three times by aspirating some of the broth and blowing it out again.

B. False membranes.—After the patient has washed out his mouth with boiled water, press the tongue down and strip off the false membrane with a pair of sterile forceps. If the membrane be friable it may be that the forceps will not pick it up, in which case it can be removed by rubbing it with a plug of sterile wool held in a pair of forceps or affixed to an iron wire.

When the membrane is detached it should be blotted firmly between two pieces of sterile filter paper to remove any contaminating organisms that may be on the surface.

6. Abscesses.

Man.

1. Cleanse and if necessary shave the skin.

2. Puncture the abscess with a needle of large calibre and aspirate the pus into a sterile syringe.

3. If the pus be inspissated and cannot be aspirated in this way, make a small incision through the skin, introduce the end of a large Pasteur pipette and aspirate the pus into the pipette, or collect some of it with a platinum loop.

Animals.

1. Shave the hair and cauterize a small area of the skin over the abscess.

2. Pass a Pasteur pipette through the centre of the eschar and aspirate the pus.

7. Aqueous humour.

Animals.

1. Fix the animal so that it cannot move and keep the eyelids retracted with a speculum. Wash the conjunctiva with warm sterile water.

2. Hold the eye firmly between the thumb and index finger of the left hand, and with a screwing movement pass a fine Pasteur pipette perpendicularly to the axis of the eye at the margin of the cornea into the anterior chamber. The fluid will ascend into the pipette without aspiration.

8. Pleural and pulmonary exudates.

Man and animals.

A small quantity of a pleural effusion can easily be collected with a sterile syringe. Use a long needle (5-7 cm.) with a large bore. When the exudate consists of thick and granular pus it is better to use a small trocar attached to a suitable syringe.

1. Asepticize the skin; to make quite sure of the asepsis the site through which the needle is to pass may be superficially cauterized.

2. Pass the needle mounted on a syringe into one of the intercostal spaces and aspirate the fluid into the syringe.

3. Transfer the material to a sterile test-tube.

These small punctures are quite unattended by danger and may, if necessary, be repeated.

The same technique may be employed, when there is no fluid in the pleura, for puncturing the lung to reach (for example) a pneumonic patch previously delimited by auscultation. In this case a fine needle is passed perpendicularly and more or less deeply through one of the intercostal spaces and a little blood-stained fluid aspirated into the syringe.

9. Ascitic fluid.

Man.

A large volume of ascitic fluid may be collected aseptically by using a trocar with sterile rubber attachment. The fluid is best collected in a sterile bottle covered with paper. The operation must be carried out under the ordinary surgical conditions and the rules for puncture of the abdomen observed.

The fine trocar of a Potain's apparatus with the india-rubber adjustments on its lateral tubulure is very useful for the purpose.

10. Tumours and lymphatic glands.

Tumours and lymphatic glands must be removed in the ordinary surgical manner, strict asepsis being maintained and care being taken that the structure is not touched with the hands.

When the tumour or gland, as the case may be, is enucleated, sterilize a small area of the surface with a well-heated iron wire, pass a sterile platinum needle or bistoury through the cauterized part and remove the material required from the centre.

11. Spleen.

Splenic puncture in man.

The spleen has been punctured for the purpose of recovering the typhoid bacillus from patients suffering from enteric fever and is sometimes practised in the study of certain other infections, *e.g.* Leishmanioses, etc.

1. Delimit the spleen by percussion and asepticize the skin.

2. Use a long needle (5 cm.) attached to a syringe by a piece of india-rubber tubing (p. 167) and penetrate the skin perpendicularly over the centre of the spleen. Aspirate, withdraw the needle, and paint the puncture with collodion.

3. A few drops of blood generally represent the material collected. This

is sown into broth by drawing some sterile broth into the syringe and expelling it again into the culture-tube.

The india-rubber connexion is absolutely necessary: it allows the needle to follow the movement of the spleen and so avoids any risk of tearing the organ.

Splenic puncture is not often performed and is not altogether unaccompanied by danger.

Splenectomy in animals.

The functions of the spleen in the resistance of the body to certain infectious diseases can be studied by observation of the results following the removal of the organ. Dogs and rats are the best animals for the experiment, but the operation can be performed on many other species.

The spleen is situated in the left flank beneath the lower false ribs and near the left curvature of the stomach.

1. Fix the animal on its right flank and anæsthetize it.
2. Shave and aseptinize the skin of the left flank. Sterilize all instruments and aseptinize the hands carefully.
3. Make an incision a few centimetres long through the skin and subcutaneous tissues immediately below the margin of the last rib, commencing at the angle and continuing parallel to the bone.
4. Cut through the aponeurosis of the external oblique and then of the internal oblique on a director.
5. Separate the fibres of the transversalis with the blunt end of a director.
6. Incise the peritoneum for the whole length of the incision.
7. The spleen will then be exposed or can readily be found by passing the finger along the greater curvature of the stomach: draw it out of the wound, being very careful not to lacerate it.
8. Tear through the gastro-splenic omentum and put a firm silk ligature around the vessel of the hilum. Cut through the pedicle on the distal side of the ligature.
9. Suture the muscles, close the skin wound with a few stitches and cover the incision with collodion.

12. Lumbar puncture.

Man.

By means of lumbar puncture, an operation devised by Essex Wynter, a needle can be passed into the cerebro-spinal canal and the fluid withdrawn. Bacteriological investigation of the cerebro-spinal fluid is of great interest and importance in cases of meningitis.

Anatomical data.—In the adult the spinal cord only reaches to the lower border of the first or upper border of the second lumbar vertebra, but in children twelve months old it reaches to the level of the third. The spinal cord cannot, then, be injured by passing a fine trocar into the spinal canal through the third, fourth or fifth lumbar spaces. In these situations the nerves comprising the cauda equina are suspended in the cerebro-spinal fluid and are collected into two lateral fasciculi separated by an interval of 5 mm. The lower down the puncture is made the smaller the chance

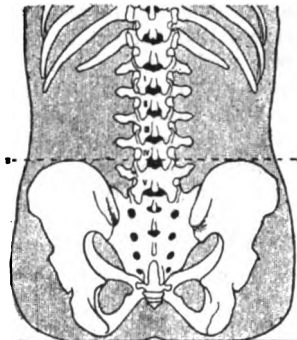

FIG. 150.—Landmarks for the operation of lumbar puncture.

of wounding the nerves since they diminish in number as the canal is descended.

The transverse width of the third and fourth lumbar spaces is from 18–20 mm. and their depth from above downwards 10–15 mm. Their shape varies with age: the fifth space between the last lumbar arch and the upper border of the sacrum is wider than but not quite so deep as the two above and marks the situation of the inferior arachnoidal cul-de-sac, which is a true reservoir of cerebro-spinal fluid.

The operation is generally performed between the fourth and fifth lumbar vertebræ. An horizontal line drawn between the highest points of the two iliac crests passes through the tip of the spinous process of the fourth lumbar vertebra; by inserting the needle immediately below this process the space between the fourth and fifth lumbar vertebræ is entered.

The depth to which the needle must be inserted will depend upon the age and also upon the state of nutrition of the patient; in a child it will be 1.5 cm., 2 cm. and sometimes 3 cm. according to its condition; in the adult, 4–6 cm. If the needle pass too far it may reach the premeningeal venous plexus and cause a slight hæmorrhage, in which case the needle must be withdrawn a little before the cerebro-spinal fluid can be collected.

Operation.—1. Sterilize a platinum-iridium needle with a short bevel and a calibre of 0.8–1 mm. and about 5 cm. long for a child and 8 cm. for an adult.

The needle should have a fine platinum wire passed through it reaching as far as the bevel but not interfering with its cutting edge.

2. Place the patient in the lateral decubitus on the edge of the bed with the thighs strongly flexed on the abdomen and the legs on the thighs, the head being slightly raised on a pillow and flexed on the thorax.

The patient may also sit up with his legs hanging over the edge of the bed, the body being bent forward and the back arched. This position, however, though more convenient for lumbar puncture, is often rendered impossible by illness and has the disadvantages of tiring the patient and stimulating muscular reaction.

3. Asepticize the skin by washing with soap, ether and alcohol. Or, more simply, paint the surface of the skin a few minutes before doing the operation, with tincture of iodine. The surgeon must of course prepare his hands as for any other surgical operation.

4. Determine the position of the line connecting the highest points of the crests of the iliac bones (*vide ante*). This line will pass through the upper border of the spinous process of the fourth lumbar vertebra.

5. Put the tip of the left index finger on the spine of the fourth lumbar vertebra and keep it in that position throughout the operation. Take the needle with the platinum wire in it in the right hand and pass it perpendicularly to the surface immediately below the spinous process and very near (not more than 1 cm. away from) the median line, slowly but deliberately into the spinal canal. Direct the needle forwards and a little upwards. The needle will pass through in order, the lumbo-sacral muscles, the ligamentum flavum, the dura mater and the arachnoid membrane. As soon as it enters the sub-arachnoid space the liquid will issue from the needle.

6. Withdraw the platinum wire and collect the fluid in a sterile test-tube.

7. Collect 5 or 6 c.c. in the case of a child and 10–15 c.c. in the case of an adult. Lumbar puncture is unattended with danger if no more fluid than this be aspirated. Withdraw the needle and paint over the puncture with iodoform and collodion. The patient should remain in bed for 24 hours after the operation.

Notes.—1. No advantage is obtained from local anæsthesia, but in the case of very nervous patients the skin may be sprayed with ethyl chloride.

2. As the needle passes through the skin there is occasionally a reflex muscular contraction of the lumbo-sacral muscles. Should this occur desist for a few moments before continuing to push the needle into the canal.

3. Should the needle be driven against bone its point will be bent and another attempt will have to be made taking a better direction.

4. If, during the operation, the needle becomes obstructed it is easily cleared with the platinum wire.

5. Occasionally the fluid is blood-stained; in that case the needle has wounded some of the small meningeal veins; this is a matter of no importance and can be remedied by slightly altering the position of the needle.

13. Milk.

Duclaux adopts the following technique which, though delicate, gives a sterile milk without any heat:

1. Take a number of plugged sterile test-tubes.

2. Wash and brush the cow's udder with soap and water, rinse with perchloride of mercury then with alcohol and finally with sterile water. The milker then sterilizes his hands.

3. Reject the first few drops of milk, which serve to wash the walls of the excretory canals.

4. An assistant takes the plug out of one of the tubes and holds the latter as close to the mouth of the teat as possible without touching it; when the tube is half-full he replaces the plug. A number of tubes may be filled in the same way.

14. Urine.

Man.

To collect urine in a sterile manner proceed as follows.

1. Take a red rubber catheter, protect the upper end with a small cap of filter paper, then wrap up the whole instrument carefully in several folds of paper and autoclave for 20 minutes at 115° C. On taking it out of the autoclave dry it in the incubator.

2. Put the man on his back and carefully wash the glans and meatus with a 1 in a 1000 solution of oxycyanide of mercury, sponge with wool which has been sterilized in the autoclave and wrap the penis in another wool sponge similarly sterilized. The operator now sterilizes his hands.

3. Remove the catheter from its paper covering by taking hold of its upper end; dip the other end in oil sterilized at 115° C.

4. Lay the catheter for a moment on the paper in which it was sterilized. Hold the penis in the left hand, and pick up the catheter about its middle with the right, introduce it into the meatus and push it along the urethra still resting the upper end on the paper which should be held by an assistant.

5. On reaching the entrance to the bladder pinch the catheter firmly between the thumb and index finger and pass the catheter through the sphincter.

6. The assistant flames the mouth of a flask previously sterilized in the hot air sterilizer, removes the wool plug and holds the mouth to the end of the catheter from which he now removes the paper cap.

7. Relax the pressure on the catheter and the urine will flow into the flask. When the latter is three-parts filled pinch the catheter to stop the flow of urine. The assistant flames the neck of the flask and replaces the wool plug which he has been holding in his left hand during the time the flask has been filling.

A similar technique can be adopted in the case of **large animals**.

Small animals (rabbits, guinea-pigs, etc.).

It is impossible to use a catheter on these small animals and the only way to collect the urine in the male is to let it flow into a sterile tube or Pasteur pipette. The animal should be fixed on its back and the emission of urine is easily provoked by laying towels wrung out in very cold water on the abdomen and loins.

15. Stools.

Stools for bacteriological examination should be collected in a sterile vessel and care must be taken that they are not mixed with urine.

When solid, cauterize the surface with a red-hot iron rod and collect some of the material from the centre. When liquid, take up the quantity required with a Pasteur pipette or platinum loop.

CHAPTER XIII.

THE BACTERIOLOGICAL EXAMINATION OF FLUIDS AND TISSUES.

Section I.—Film preparations, p. 203.

1. Unstained preparations, p. 203. 2. Stained preparations: A. Preparation of films—(a) Fluids, p. 204; (b) Scrapings of organs, p. 205; (c) Sputum, p. 205. B. Staining methods: (a) Simple staining, p. 205; (b) Differential staining, p. 207.

Section II.—Histological preparations, p. 211.

1. Instruments, p. 211. 2. Freezing methods, p. 212. 3. Paraffin embedding methods, p. 212. 4. Preliminary treatment of sections, p. 215. 5. The staining of sections: A. Simple staining, p. 216; B. Differential staining, p. 217.

SECTION I.—FILM PREPARATIONS.

Pathological material whether taken during life or after death, from man or from one of the lower animals, may be examined:

1. either fresh and unstained, or
2. after drying and staining.

1. Unstained preparations.

(a) **Fluids.**—Blood, fluid exudates and pus may be collected in a Pasteur pipette and ought to be examined at once.

The examination of blood may be described in illustration of the method. As soon as the blood is removed from the body a drop is placed on a slide and covered with a cover-glass; the blood spreads out in a thin layer between the slide and cover-glass, and by pressing lightly on the latter the excess can be squeezed out at the edges and wiped away with a piece of soft linen. In this way a very thin uniform layer is obtained and must be examined immediately (obj. D; oc. 2 Zeiss).

The slides and cover-glasses must be absolutely clean, because dirt or grease prevents the blood from spreading in a thin and uniform layer, and renders satisfactory examination of it impossible. It is also essential that the red cells should not be heaped one on another, as this would mask the presence of micro-organisms.

Should the examination be very prolonged the edges of the cover-glass may be luted with paraffin, but in the majority of cases this is unnecessary, because the blood at the edges of the cover-glass, being in contact with the air, coagulates and thus affords sufficient protection to the central parts of the preparation.

Serous exudates, liquid pus, etc., should be treated in the same way; but if the pus be inspissated it must be treated as though it were a scraping from an organ.

A warm stage can be used to maintain the preparations at the temperature of the body (p. 135).

(b) **Scrapings of organs.**—Scrapings of the internal organs are to be collected in the manner already described (Chap. XI.), and transferred with a platinum loop to a slide on which they are rubbed up in a drop of filtered water or, better, in a drop of normal saline solution (water 1000, NaCl 8, filter, distribute in tubes, sterilize in the autoclave); then spread the material with a platinum loop, cover with a cover-glass, and examine at once (obj. D; oc. 2 Zeiss).

2. Stained preparations.

Before being stained fluids and scrapings of organs should be spread in a thin layer on a slide or cover-glass, and dried and fixed to preserve the form of the cells and to make them adhere to the surface of the glass.

A. Preparation of films.

(a) Fluids.

The treatment of fluids such as blood, serous exudates, pus, etc., will first be described.

1. **Spreading of films.** (a) **On cover-glasses.**—1. Hold a perfectly clean cover-glass by one of its angles, A, and place a drop of the fluid to be examined in the centre.

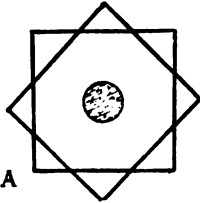

FIG. 151.—Preparation of films on cover-glasses.

2. Cover with a second cover-glass laying the latter across the former as shown in the figure (fig. 151).

3. Take hold of the second cover-glass at the angle B, opposite to A, and slide them apart so that the liquid is spread out in a thin, uniform layer.

4. Allow the films to dry either in the air or by placing them on a drying stand heated to 40° or 45° C. (fig. 127, p. 141).

(β) **On slides.**—For pus, serous exudates, etc., slides may be used in a similar way to cover-glasses: place the drop of fluid near one end of the slide, lay another slide over it and then draw the two slides apart.

For blood the following method is better :

1. Take a perfectly clean slide and lightly touch the drop of blood as it oozes from the prick, taking care that the blood is drawn up by the slide and not the slide pressed down on to the drop.

2. Hold the slide in the left hand, apply the edge of a cover-glass to the drop of blood and the latter will spread along the edge of the cover-glass by capillary action. (The end of a slide or a visiting card or even a small glass stirring rod will serve equally as well as a cover-glass.)



FIG. 152.—Preparation of a blood film on a slide.

3. Draw the cover-glass slowly and without pressing upon it towards the other end of the slide. In this way a very thin and uniform layer of blood is left on the slide which dries as fast as the cover-glass passes over it (fig. 152).

The preparation of satisfactory blood-films requires a certain amount of practice, so that if the first attempts fail one must not be discouraged; remember always that absolutely clean and flat slides and cover-glasses are indispensable.

2. Fixation.—Several methods are available for fixing films on slides and cover-glasses.

(a) **Heat.**—The slide or cover-glass with the film upwards is held in a pair of Cornet's forceps (fig. 118, p. 131) and passed three times through the heating flame of a Bunsen burner or spirit lamp. The shape of the cells is somewhat distorted by this procedure and it cannot therefore be used (for example) for fixing blood-films.

(β) **Alcohol-ether.**—Pour two or three drops of alcohol-ether on the cover-glass (p. 141) and allow it to dry in the air. This method is preferable to the preceding as it preserves absolutely the shape of the cells. It is occasionally necessary to allow the solution to act for several minutes.

(γ) **Absolute alcohol.**—In many cases absolute alcohol can be used in place of alcohol-ether for fixing films. The technique is the same as that described in the preceding paragraph. With many dyes staining is facilitated by allowing the alcohol to act for 10–30 minutes.

(δ) Other solutions are occasionally used for fixing films, e.g. osmic acid vapour, absolute methyl alcohol, etc. These will be referred to when occasion for their use arises.

(b) Scrapings of organs.

Films of the internal organs are prepared as follows :

1. Transfer to a slide with a platinum loop or pipette a small piece of tissue from the organ, and spread it by rubbing it on the slide so as to cover a rectangular area about 15–20 mm. square. Or a piece of the tissue (liver, spleen, etc.) may be taken up in a pair of dissecting forceps and lightly rubbed over the surface of the slide.

The film in any case should be thin and uniform and any lumps which would interfere with the application of a cover-glass must be removed.

2. Dry as above.

3. Fix by heat or with alcohol-ether.

Films of the brain or spinal cord should always be washed several times in the alcohol-ether mixture after fixing to remove fatty matters, as these would interfere with the subsequent staining processes.

(c) Sputum.

When the sputum is fluid it can be treated as a fluid exudate, but should it be tough or inspissated it should be spread with a platinum loop on a slide ; it will facilitate the preparation of a thin and uniform film if the slide be gently heated while the sputum is being spread. Dry and fix.

B. Staining methods.

Films whether of fluids or scrapings of organs contain structures of two different kinds.

1. The groundwork, which is formed of tissues of animal origin—cells and amorphous elements.

2. Bacteria, which are of vegetable origin.

Such films may be stained in one of two ways,

(a) With a *simple stain* by which at a single operation the groundwork and the micro-organisms are stained the same colour.

(b) With a *double stain* by means of which the micro-organisms are differentiated from the groundwork by being stained a different colour.

(a) Simple staining.

A blood film or a scraping of an organ may be stained with any of the dyes described in Chapter VIII.

The stain most generally used is carbol-thionin (p. 138). The technique is as follows :

A. Cover-glasses.—1. Hold the cover-glass in a pair of Cornet's or Debrand's forceps and pour on to the film sufficient stain to cover the surface.

Allow the stain to act for 30–60 seconds.

2. Wash in distilled water.

3. Mount the cover-glass on a slide film downwards in a drop of water. Examine with a $\frac{1}{2}$ objective and No. 2 ocular.

4. If the preparation be satisfactory it may be mounted permanently, by drying it in the air or gently heating it and then mounting in Canada balsam.

To sum up : stain, wash in water, dry, mount in balsam.

B. Slides.—Films made on slides are stained in a similar manner. Hold the slide in the left hand or in a pair of Debrand's forceps ; flood the slide with stain ; wash in water, dry ; place a drop of cedar-wood oil on the film and examine with an immersion lens. The preparation may be mounted by placing a drop of balsam on the film and covering with a cover-glass.

Dilute carbol-fuchsin, the various carbol-violet stains, Kuhne's or Loeffler's or Roux's blue, etc. may any of them be used in suitable cases in place of carbol-thionin. The particular stain which is most useful for the detection and study of the different species will be referred to in the chapters devoted to those species.

The disadvantage of the simple stains is that as they stain the groundwork and the organisms the same colour (fig. 153) ; the latter fail to stand out



FIG. 153.—Simple staining.

Scraping from gum stained with dilute carbol-fuchsin (oc. 2, obj. $\frac{1}{2}$ th, Zeiss).

conspicuously, especially when they are few in number or when the film is thick. The methods of differential staining are adopted to overcome these defects.

Examination of the blood.—In the case of blood-films the necessity for double staining may be avoided by getting rid of the groundwork. Thus if the hæmoglobin (which is the only substance in the red cells which takes the stain) be eliminated there remains after staining a colourless groundwork on which the micro-organisms stand out conspicuously. This result may be effected in one of two ways :

(a) **Gunther's method.**—1. Dry the film by gently heating it and then

without passing it through the flame cover it with a 5 per cent. solution of acetic acid, and leave for 30 seconds.

2. Expose to the vapour of ammonia for a few seconds.

3. Wash in water.

4. Stain, wash, dry and mount.

(β) **Vincent's method.**—1. Dry the film by gently heating it, and, without fixing, flood the film with the following solution :

| | | | | | |
|--|---|---|---|----|------|
| 5 per cent. aqueous solution of carbolic acid, | - | - | - | 6 | c.c. |
| Saturated aqueous solution of common salt. | - | - | - | 30 | „ |
| Glycerin (pure), | - | - | - | 30 | „ |

and allow it to act for 1–2 minutes.

2. Wash in water, stain, etc.

(γ) **Direct staining of blood-films.**—Lastly, simple staining with Loeffler's blue gives very good results with blood-films; the red cells are sharply differentiated from the micro-organisms, the former being stained pale green and the latter deep blue. Carbol-thionin is also useful in that it stains the nuclei of the leucocytes and the organisms but leaves the red cells practically unstained.¹

(b) Differential staining.

In dealing with micro-organisms which retain the stain by Gram's method it is easy to get a double-stained preparation. But when the organism under investigation does not stain by this method more delicate processes which often give less satisfactory results have to be employed. Finally, in the search for and in the study of certain organisms, such for example as the tubercle and leprosy bacilli, special methods, of which Ehrlich's is a type, have to be adopted. They will be described in the chapter devoted to the tubercle bacillus.

A. Gram's method and its modifications.

The procedure originally described by Gram has undergone various modifications: reference will be made to the more important of these. Meanwhile the beginner must be warned against the danger of practising a large number of methods. The secret of success lies in the thorough understanding of one reliable procedure; if this advice be neglected the result may be error and failure and consequent discouragement. The method described under (β) is the one recommended.

(α) **Gram's method.**—1. Flood the slide or cover-glass with aniline-gentian-violet (p. 139). Let the stain act for 2–4 minutes.

2. Pour off the stain and, without washing, flood the film with Gram's iodine solution. Let it act for about a minute until the preparation assumes a blackish tint.

3. Wash in distilled water.

4. Decolourize with absolute alcohol (p. 143) until the film assumes a pale grey tint.

5. Wash in distilled water.

6. Flood the film with a solution of eosin :

| | | | | | | | | | |
|----------------------|---|---|---|---|---|---|---|-----|-------|
| Water-soluble eosin, | - | - | - | - | - | - | - | 1 | gram. |
| Distilled water, | - | - | - | - | - | - | - | 200 | c.c. |

Allow the eosin to remain on for 1–2 minutes.

7. Wash in distilled water and dry.

8. If the preparation has been made on a slide, a drop of cedar-wood oil

¹ In the case of birds' blood, the nuclei of the red cells are deeply stained by these dyes.

may be placed on the film and the preparation examined at once with an oil-immersion lens.

Films made on cover-glasses should first be examined in water, and if satisfactory they can then be mounted in balsam after drying and clearing in clove oil and xylol.

In preparations stained as above the groundwork is pink and the micro-organisms violet. Decolourization must be continued until all traces of violet have disappeared from the groundwork (fig. 154).

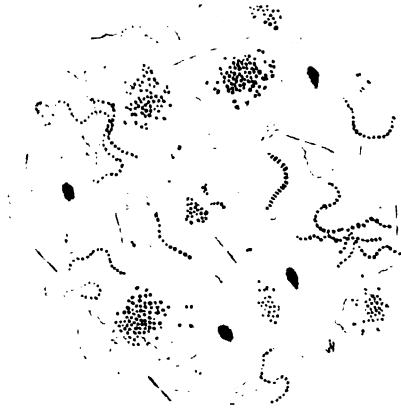

FIG. 154.—Gram's stain.

Scraping from gum stained by Gram's method (oc. 2, obj. $\frac{1}{3}$ th, Zeiss).

Blood-films stained by Gram's method give very beautiful preparations. When dealing with the blood of birds the action of the alcohol must be continued until all but the nuclei of the red cells are decolourized and must be stopped short of complete decolourization, so that after counter-staining with eosin the protoplasm of the red cells is stained red while the nuclei of the red cells and the micro-organisms are stained violet.

Note.—Vesuvian can be used as a counter-stain instead of eosin.

| | | | | | | | | | | |
|------------------|---|---|---|---|---|---|---|---|---|----------|
| Vesuvian, | - | - | - | - | - | - | - | - | - | 5 grams. |
| Distilled water, | - | - | - | - | - | - | - | - | - | 100 c.c. |

Micro-organisms which retain the stain by Gram's method are then stained deep violet while gram-negative organisms and the nuclei of the leucocytes are dark brown and the protoplasm of the leucocytes light brown.

(β) **Method recommended.**—1. Flood the film with carbol-gentian-violet (p. 138). Stain for about a minute.

2. Without washing, replace the violet with Gram's iodine and stain for 1-2 minutes.

3. Wash in distilled water.

4. Decolourize with absolute alcohol.

Instead of using absolute alcohol alone the process may be hastened by washing first with alcohol then with aniline oil and again with alcohol. But it should be pointed out that aniline oil is a very powerful decolourizing agent and should therefore only be allowed to act for a few seconds.

5. Wash in distilled water.

6. Counterstain with an aqueous solution of eosin as before.

7. Wash, dry, mount and examine as above (a).

(γ) **Nicolle's method.**—1. Stain with carbol-gentian-violet (p. 138) for 20-30 seconds.

2. Without washing, replace the violet by a modified Gram's iodine solution made as follows :

| | | | | | | | | |
|-------------------|---|---|---|---|---|---|---|----------|
| Iodine, | - | - | - | - | - | - | - | 1 gram. |
| Potassium iodide, | - | - | - | - | - | - | - | 2 grams. |
| Distilled water, | - | - | - | - | - | - | - | 200 c.c. |

Allow the solution to act for 4-6 seconds, renewing it once or twice during that period.

3. Wash in distilled water.

4. Decolourize with an acetone-alcohol solution :

| | | | | | | | | |
|-------------------|---|---|---|---|---|---|---|------------|
| Absolute alcohol, | - | - | - | - | - | - | - | 5 volumes. |
| Acetone, | - | - | - | - | - | - | - | 1 volume. |

Decolourization does not take place at once and is only fully manifested after washing in distilled water.

5. Wash in distilled water.

6. Stain the ground work rapidly with an alcoholic solution of eosin :

| | | | | | | | | |
|---|---|---|---|---|---|---|---|------------|
| Saturated solution of eosin ¹ in 95 per cent. alcohol, | - | - | - | - | - | - | - | 1 volume. |
| Alcohol (95 per cent.), | - | - | - | - | - | - | - | 2 volumes. |

7. Wash, dry, mount, and examine as before.

(δ) **Merieux's method.**—In the author's experience this method has never given results equal to those obtained with the methods already described.

1. Stain with carbol-violet as in (γ).

2. Treat with the following solution for 4-6 seconds, renewing the solution once or twice during that time :

| | | | | | | | | |
|---|---|---|---|---|---|---|---|----------|
| Iodine, | - | - | - | - | - | - | - | 1 gram. |
| Potassium iodide, | - | - | - | - | - | - | - | 2 grams. |
| Saturated solution of eosin ² in 50 per cent. alcohol, | - | - | - | - | - | - | - | 20 c.c. |
| Distilled water, | - | - | - | - | - | - | - | 200 „ |

3. Wash in distilled water.

4. Decolourize in a 1 in 6 solution of acetone in alcohol (*vide supra*).

5. Wash, dry, mount and examine.

(ε) **Kühne's method.**—1. Stain for several minutes in carbol-blue (p. 138) or in ammoniacal blue (p. 139).

2. Wash in distilled water.

3. Treat with Gram's iodine solution for 2-3 minutes.

4. Wash in distilled water.

5. Decolourize with a saturated solution of fluorescein in absolute alcohol.

6. When the ground-work no longer appears blue, wash in absolute alcohol then in clove oil and xylol, and mount in balsam.

The bacteria appear violet on a background lightly tinted with fluorescein.

B. Claudius' method.

This method as already described on p. 136 can be used for staining smear preparations.

C. Methods available for staining organisms which are gram-negative.

1. Blood-films.

In double staining blood-films containing gram-negative organisms use is made of the property possessed by the red cells of combining with eosin, and also of the marked selective affinity shown by bacteria for the basic aniline dyes.

Note.—The three methods about to be described are the original methods. They have undergone many improvements which, being specially adapted to work on the Hæmatozoa, will be considered in the chapter (LVIII.) dealing with these organisms.

¹ Alcohol-soluble eosin.

² Water-soluble eosin.

(*α*) **Laveran's method. Method recommended.**—1. Flood the film with an aqueous solution of eosin (p. 207). Stain for about a minute.

2. Replace the eosin with a saturated aqueous solution of methylene blue and stain for about 30 seconds.

3. Wash in distilled water.

4. Dry and mount in balsam.

The red cells are stained pink while the bacteria and the nuclei of the white cells are blue. In the blood of birds the nuclei of the red cells are also stained blue.

(*β*) **Chenzinsky's method.**—1. Lay the cover-glass, film side downwards, in a small ground-glass covered glass dish containing a little of the following solution which must have been recently prepared :

| | |
|--|---------|
| Saturated aqueous solution of methylene blue, - - - | 40 c.c. |
| 0.5 per cent. solution of water-soluble eosin in 70 per cent. alcohol, - - - | 20 " |
| Distilled water, - - - | 40 " |

Leave the film to stain in the glass dish in the warm incubator at 37° C. for 3–6 hours.

2. Then wash the film in distilled water, dry, and mount in balsam.

(*γ*) **Romanowsky's method.**—1. After drying and fixing in the flame, place the film in a drying oven at 105°–110° C. for about an hour.

2. Then immerse the cover-glass in the following staining solution which must be newly made up and not filtered :

| | |
|--|----------|
| Saturated aqueous solution of Höchst's medicinal methylene blue, - - - | 2 parts. |
| 1 per cent. aqueous solution of eosin A.G. (Höchst), - - | 5 " |

Stain for 2–10 hours.

3. Wash in distilled water.

4. Dry, and mount in balsam.

2. Films of pus, etc.

(*α*) **Kühne's method.**—1. Stain for a few minutes with carbol-blue (p. 138).

2. Wash in water.

3. Wash in dilute hydrochloric acid until the film assumes a pale blue colour (this is rather a delicate proceeding and the time required will vary with the thickness of the film).

Dilute hydrochloric acid.

| | |
|-------------------------------|--------|
| Pure hydrochloric acid, - - - | 1 c.c. |
| Distilled water, - - - | 1000 " |

4. Remove the excess of acid by washing in an alkaline lithia solution.

| | |
|--|--------|
| Saturated aqueous solution of carbonate of lithia, - - - | 5 c.c. |
| Distilled water, - - - | 100 " |

5. Wash well in water.

6. Dry, clear in clove oil and xylol, and mount in balsam. The groundwork is stained pale blue and the micro-organisms deep blue.

(*β*) **Nicolle's method. Method recommended.**—1. Stain for a few minutes in carbol-blue.

2. Wash in water.

3. Treat for 2 or 3 seconds with a few drops of the following solution :

| | |
|------------------------|-----------|
| Pure tannin, - - - | 10 grams. |
| Distilled water, - - - | 100 " |

4. Wash in water.

5. Treat rapidly with absolute alcohol, clove oil and xylol, and mount in balsam.

The ground-work is stained very pale violet-blue and the organisms deep blue.

SECTION II.—HISTOLOGICAL PREPARATIONS.

For the demonstration of micro-organisms *in situ* in tissues very thin sections (0.05 mm.) must be cut. Hand-cut sections are not sufficiently thin for purposes of bacteriological investigation, so that the tissue must be cut with a microtome, which involves the embedding of the tissue first of all in some suitable material.

The materials ordinarily used in histology for embedding tissues (gum, wax, soap, celloidin and collodion) do not lend themselves to the cutting of very thin sections, so that for bacteriological purposes the tissue is either frozen or embedded in paraffin.

1. Instruments.

Microtomes.—Most of the mechanically-worked microtomes are suitable for cutting the thin sections required in bacteriological work. For paraffin sections, Minot's, Radais' and the Cambridge "rocking" microtome (fig. 155) are among those in most frequent use.

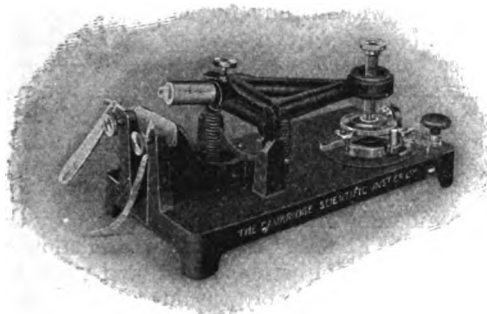

FIG. 155.—Cambridge "rocking" microtome.

It will be unnecessary here to discuss the construction of the different forms of microtome and the method of working them, for a careful examination of the instrument itself will be of far more assistance than any detailed description.

It will suffice to say that microtomes being instruments of precision must be carefully handled; that they must be cleaned every time after use, and be protected from dust and damp by being kept under a bell jar or in a wooden box.

Microtome razors.—A good razor is indispensable for the cutting of satisfactory sections. One surface of the razor must be flat (the one in contact with the paraffin block). The cutting edge must be sufficiently sharp to sever a hair held between the finger and thumb or one of the fine hairs on the back of the hand.

Always strop the razor before using it, first on the prepared surface of the strop and then on the dry surface, remembering to strop with the back foremost and to pass from heel to tip, stropping each side of the razor alternately.

It is useful also to ensure satisfactory results and to avoid having to send it frequently to the instrument-maker to know how to sharpen a razor on a stone. The razor must be passed with the edge foremost from heel to tip;

the stone should not be oiled, but simply moistened with a little water or better still with the following solution :

| | | | | | | | | |
|-------------------------|---|---|---|---|---|---|---|---------|
| Distilled water, | - | - | - | - | - | - | - | 50 c.c. |
| Alcohol (95 per cent.), | - | - | - | - | - | - | - | 50 " |
| Glycerin, | - | - | - | - | - | - | - | 50 " |

After use the razor should be dried on a piece of soft rag, lightly stropped, and returned to its case.

To cut sections embedded in paraffin the blade of the razor should be dry and be placed obliquely to the tissue. The sections, as they are cut, should be picked up from the razor with a pair of fine forceps or a piece of silk paper, never with a needle or scalpel or other similar instrument which might damage the cutting edge of the razor.

2. Freezing methods.

Though frozen tissues cannot be cut so thin as tissues embedded in paraffin, the freezing method has the advantage that sections can be cut in a very short time, and can be stained in a variety of ways; and hence is of particular value for purposes of rapid diagnosis.

Only tissues which have been previously fixed should be cut by the freezing method. Formalin (10 per cent.) is perhaps the best for the purpose (p. 189), as tissues can be frozen without any further treatment. Tissues fixed by other methods should be washed and then put in formalin for a few hours. Tissues for frozen sections should not be more than 5-6 mm. thick.

Microtomes.—The simplest type for frozen sections is a rocking microtome or a Minot. Place the tissue wet with formalin on the carrier of the microtome and direct a jet of methyl chloride on to it until it is firmly frozen to the carrier, then adjust the latter to the microtome and cut the sections.

Of microtomes specially arranged for cutting frozen sections the best are those of Becker and Miller, in which the tissue is frozen by the decompression of liquid carbonic acid. The tissue is placed in an hollow carrier connected by an iron tube to a cylinder of carbonic acid, and when arranged in place on the microtome is frozen by simply turning on the tap of the cylinder. When the tissue is frozen the gas is turned off and the sections cut. If the sections show a tendency to tear, it is because the tissue has been frozen too hard, in which case it must be left for a few seconds.

Transfer the sections to ordinary water in which they will uncurl; when uncurred they are ready for staining.

3. Paraffin embedding methods.

A. Xylol method. Method recommended.—The pieces of tissue after being fixed in the manner described in Chapter XI. are treated as follows:

1. Dehydrate carefully in absolute alcohol or acetone for 24 hours or thereabouts.

2. Transfer to xylol.

| | | | | | | |
|---------------------------------|---|---|---|---|---|----------------|
| Very small pieces (1-3 mm.) for | - | - | - | - | - | 30-60 minutes. |
| Small pieces (3-5 mm.), | - | - | - | - | - | 2 hours. |
| Medium-sized pieces (5-10 mm.), | - | - | - | - | - | 3-4 " |
| Thick pieces (10 mm. or more). | - | - | - | - | - | 4-5 " |

In the case of the last it is as well to change the xylol once or twice to make quite sure that all traces of alcohol will be removed.

3. After dehydrating, transfer to a mixture of xylol and paraffin melting at 35° C. Such a mixture can be made as follows :

| | | | | | |
|---|---|---|---|---|--------------|
| Paraffin ¹ (melting point 50° C.), | - | - | - | - | 10-15 grams. |
| Xylol, | - | - | - | - | 30 c.c. |

¹ For embedding, the paraffin sold by Dumaige of Paris is recommended.

The tissue should be placed in the mixture in a well-stoppered bottle and be kept in the warm incubator (37°-38° C.) for from 1-6 hours according to the thickness of the block.

4. After passing through the xylol-paraffin bath transfer to an open flask or tube containing paraffin melting at 50° C. and heated to 52°-53° C. (the

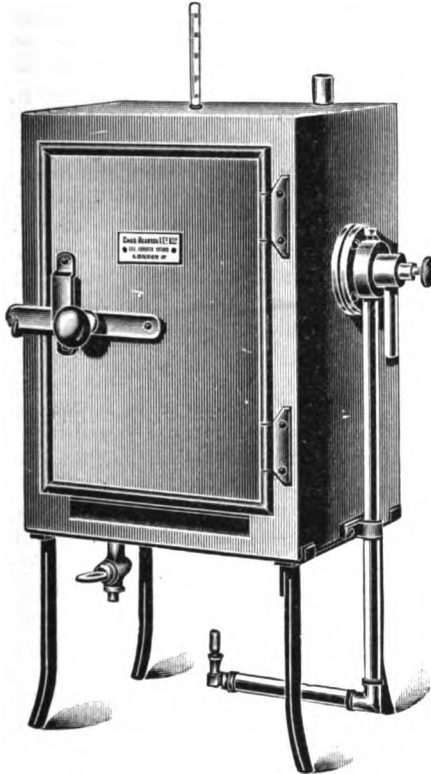

FIG. 156.—Paraffin oven.

temperature must never reach 55° C.) in a paraffin oven (fig. 156) for ½-4 hours according to the thickness of the tissue.

| | |
|--------------------------------|-------------|
| Very thin pieces, - - - - - | 30 minutes. |
| Thin pieces, - - - - - | 1-2 hours. |
| Medium-sized pieces, - - - - - | 2-3 " |
| Thick pieces, - - - - - | 3-5 " |

5. The tissue is now ready to be embedded. Melt some paraffin (melting point 50°, 52° or 55° C.) in a porcelain capsule. (For sections for bacteriological examination paraffin melting at 52° C. is, generally speaking, the best, but if the weather is very warm paraffin melting at 55° C. may be preferred.) After the paraffin has been melted allow it to cool until a pellicle forms on the surface.

While the paraffin is melting select a mould and cover the bottom with a thin layer of the melted paraffin, and as soon as it has begun to set (a few seconds is sufficient) place the tissue, which may be conveniently held with a lightly heated needle, on the surface, taking care that it is placed in a good position and suitably orientated; then fill up the mould with melted paraffin,

being careful that the tissue is embedded to a depth of several millimetres to allow for the contraction which will take place during cooling.

As soon as the paraffin has set sufficiently to hold the tissue the needle which was used to retain the latter in position should be taken away. The paraffin should be cooled rapidly by plunging the mould into cold water, being careful first to moisten the bottom and not to immerse the mould completely before the paraffin has cooled sufficiently to allow of the formation of a crust on the surface, otherwise of course the water would penetrate into the paraffin and destroy the homogeneity of the mass.

6. When the paraffin is firmly set, take it out of the mould and the tissue is ready for cutting.

Paraffin moulds.—1. The simplest mould is one made out of paper in the following manner: Select a cork which loosely fits the carrier on the microtome, and roll round it a strip of filter paper—which may be fastened by pinning it to the cork—so as to form an hollow cylinder 2 or 3 cm. deep, the bottom being formed by the upper surface of the cork. This surface may, with advantage, be scored with a few small grooves cut with a scalpel to ensure the paraffin adhering more firmly to it. Oil the inner surface of the paper with a brush avoiding the surface of the cork at the bottom of the cylinder.

Pour the melted paraffin into this cylinder and when it has set take out the pin and unroll the paper; the paraffin with the tissue embedded in it will remain attached to the cork. Trim up the surface of the paraffin and fix the cork into the carrier of the microtome. The block is then ready for cutting.

2. The lead capsules used for covering the corks of bottles serve the same purpose excellently. When the paraffin has set the capsule is torn off, leaving a solid block of paraffin which can be trimmed up at leisure with a slightly heated scalpel. Blocks cast in such a mould can be easily fitted to the carrier of the microtome. In using a Minot microtome it is only necessary to heat gently the grooved metal carrier and to press the lower surface of the paraffin block lightly against it. To fix the block to the wooden cube or cylinder used with other microtomes apply the blade of a lightly heated scalpel to the lower surface of the block, and while the paraffin is still soft press it on to the wood block; or if preferred a little melted paraffin may be poured on to the latter and the paraffin block pressed on to it.

In the same way small cardboard or wooden boxes, cover-glass boxes for example, make very good moulds; these must be painted on the inside with glycerin or oil to prevent the paraffin adhering to the sides.

3. By using Leuckart's moulds blocks of various sizes with perfectly smooth and parallel sides are obtained. These moulds consist of two pieces of brass, which can be placed together in such a way that they form a rectangular box (fig. 157). The surfaces of the two pieces of metal are smeared with

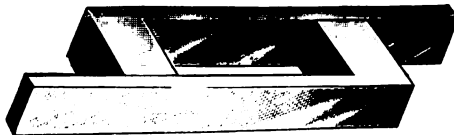

FIG. 157.—Paraffin moulds.

glycerin and laid on a piece of glass which has also been smeared with glycerin and they are then arranged so as to form a box of the size required. The melted paraffin is poured into the box and when it has set the two pieces

of metal are pushed apart and the paraffin with the tissue embedded is free.

B. Toluene method.—The technique is exactly the same as when using xylol except that toluene is substituted for xylol.

C. Ether method.—1. When the tissue is taken out of absolute alcohol it is transferred to alcohol-ether for from 30 minutes to 6 hours according to the size of the tissue.

2. The tissue is then immersed in pure ether for at least as long as it was in the alcohol-ether mixture.

3. It is then transferred to an hermetically sealed flask containing ether saturated with paraffin melting at 50° C. and placed in the warm incubator at 37°–38° C. (see under xylol for duration of treatment).

4. The block is now immersed in paraffin melting at 50° C. and embedded in the manner described under xylol.

4. Preliminary treatment of sections.

Before sections can be stained the paraffin which has penetrated the interstices of the tissue must be removed.

A. Method recommended.—1. As soon as they are cut the sections are placed in a ground-glass stoppered vessel containing ether which rapidly dissolves the paraffin. The length of time required will vary from several minutes to a few hours according to the size and number of the sections treated.

2. When all the paraffin has dissolved the sections are transferred with a platinum or nickel spatula (fig. 158) to a second bath containing absolute alcohol.

3. After being in absolute alcohol for a few minutes the sections are transferred one by one with a spatula to a glass dish full of distilled water. As soon as they come in contact with the water the sections spin round and round very rapidly and at the same time unroll and spread themselves flat.

If the sections are very thin and fragile this gyratory movement may tear them and render them useless, so that it is better to pass such sections from absolute alcohol to 70 per cent. then to 40 per cent. alcohol before placing them in distilled water.

4. To transfer a section to a slide, dip the slide obliquely into the water and beneath one of the sections, then fixing the section with a needle raise the slide and gently draw it out of the water, holding the section with the needle about the centre of the slide on which it will spread out. Blot up the excess of water with a cigarette paper or a piece of silk paper (which should be kept ready cut up into small rectangular pieces, and not torn off as required since the rough edges might pick up the section from the slide) and the section is now ready for staining.

B. Albumin fixation.—The method just described is the simplest and, in the hands of those used to the work, applicable to the majority of cases. But when the sections are very delicate—sections of lung, for instance,—there is a risk that they may be torn during the various manipulations. In such a case it is invariably necessary to fix the section on the slide immediately it is cut. The fixative generally used in bacteriology is Mayer's albumin.

Mayer's albumin.—Beat up the white of two eggs into a snow, leave them



FIG. 158.—
Section lifter.

to stand, then filter through filter paper and add an equal volume of glycerin to the clear filtrate. Add a little piece of camphor or thymol as a preservative and keep in a well-stoppered bottle. Before using the solution shake the bottle well to ensure the mixture being homogeneous.

Method of use.—Place a drop of the albumin on the slide and spread it in a very thin layer with the tip of the index finger. Transfer the section with a spatula direct to the prepared slide, carefully spread it out with a fine brush so that there are no folds and press it lightly to make it adhere to the albumin.

Should there be any difficulty in getting the sections to spread, a drop of water may be placed on the slide already smeared with the albumin mixture and the section laid on the drop of water. The slide is then gently heated on the drying stage (fig. 127, p. 141) until the section has spread evenly, the excess of water is then taken up with a piece of silk paper and the process continued as below.

Heat the under side of the slide very lightly over the pilot flame of a Bunsen and in a few seconds the section will have adhered to the surface of the glass. The section is now treated with xylol and then with absolute alcohol to remove the paraffin, after which it is ready for staining.

Nota.—The albumin-fixation method has the disadvantage of not being universally applicable: it cannot, for instance, be used with alkaline solutions, Orth's picrocarmine, etc., which dissolve albumin.

5. The staining of sections.

In order to render the detection of micro-organisms as easy as possible and to facilitate their study, it is desirable that they should be stained a different colour from the tissue in which they are contained; hence it is best to use either a double or triple staining method. Unfortunately such methods are of little use when dealing with an organism which is gram-negative and which does not stain either by Ehrlich's or Ziehl-Neelsen's method. In such a case it is sometimes not possible to differentiate further than by staining with a simple stain in such a way that the background (the animal tissue) is only lightly stained while the bacteria (the vegetable tissue) are stained much more deeply. Recently, however, methods of double staining applicable to gram-negative organisms have been devised and two of these will be described.

The description of Ehrlich's and Ziehl-Neelsen's methods will be deferred to the chapter on tuberculosis.

A. Simple staining.

Methods applicable to most organisms.

(a) **Weigert's method.**—1. Cover the section with a few drops of aniline-gentian-violet (p. 139). Allow the stain to act for 30 minutes or so and then blot up the excess.

2. Immerse the section for a few seconds in a vessel containing a 0.5 per cent. aqueous solution of acetic acid.

3. Wash carefully in distilled water and blot up the excess.

4. Dehydrate *very rapidly* in absolute alcohol.

5. Clear in clove oil then in xylol.

6. Mount in Canada balsam.

(β) **Loeffler's method.**—The stains used are Loeffler's alkaline blue (p. 139) (15 minutes) or Ziehl's fuchsin (p. 138) (5 or 6 minutes). The technique is otherwise the same as in the preceding method.

(γ) **Kühne's method A.**—1. Stain for 15 minutes in carbol-blue or ammoniacal blue (pp. 138 and 139).

2. Transfer to distilled water.

3. Treat for a few seconds with dilute hydrochloric acid (1-1000).
 4. Transfer rapidly to lithia solution (p. 210).
 5. Wash again carefully in distilled water. Blot up the excess of water and leave the section exposed to the air until it is nearly dry.
 6. Dehydrate *as rapidly as possible* in absolute alcohol.
 7. Clear in clove oil and xylol.
 8. Mount in Canada balsam.
- (ð) **Kühne's method B.**—This method is not recommended. It is very tedious and only stains a few species of micro-organisms.

1. Stain for about 30 minutes in carbol-blue.
2. Wash in distilled water.
3. Treat with dilute hydrochloric acid (1-1000) until the tissue is pale blue.
4. Wash in lithia solution (p. 210).
5. Wash for several minutes in distilled water and blot up the excess.
6. Dehydrate *very rapidly* in absolute alcohol lightly tinted with methylene blue.
7. Pour off the alcohol and treat with aniline oil similarly tinted with blue for about 2 minutes.
8. Replace the tinted aniline oil with ordinary aniline oil for about 2 minutes.
9. Clear with clove oil and then with two lots of xylol to ensure the removal of all traces of aniline oil.
10. Mount in Canada balsam.

(e) **Staining with thionin. Method recommended.**—1. Stain with carbol-thionin (p. 138) for several minutes.

2. Wash in distilled water and blot up the excess.
3. Dehydrate *very rapidly* in absolute alcohol.
4. Clear in clove oil and xylol.
5. Mount in Canada balsam.

(f) **Gram's method for the typhoid bacillus.**—1. Stain for a few hours in aniline-gentian-violet (p. 139).

2. Wash the section in distilled water.
3. Transfer for 1 minute to a 1 per cent. solution of hydrochloric acid.
4. Wash carefully in distilled water: blot up the excess.
5. Dehydrate *very rapidly* in absolute alcohol.
6. Clear in clove oil and xylol.
7. Mount in Canada balsam.

By this method the bacilli alone are stained.

(g) **Nicolle's tannin method. Method recommended.**—1. Stain the section for 2 or 3 minutes in Loeffler's or Kühne's blue.

2. Wash in distilled water.
3. Treat for a few seconds in a 10 per cent. aqueous solution of tannin.
4. Wash in distilled water and blot up the excess.
5. Dehydrate rapidly in absolute alcohol.
6. Clear in clove oil and xylol.
7. Mount in Canada balsam.

B. Differential staining.

1. Methods applicable to gram-positive organisms.

To demonstrate the presence of gram-positive organisms in a tissue in which they are present the background (the animal tissue) is first stained with an acid dye which has but little affinity for micro-organisms, then by Gram's method. The bacteria being the only structures stained violet stand out sharply from the other tissues.

The background may be stained with one of several dyes.

For double staining, eosin, fluorescein, carmine (Orth's), vesuvin, Bøhmer's hæmatoxylin, aurantia, hæmatein, etc., are used.

For triple staining a selective dye is chosen which will stain the various tissues different colours. This method of staining enables the lesions produced by the organisms to be studied. The stains ordinarily used are Orth's picrocarmine or hæmatoxylin in conjunction with aurantia or eosin. The following are the formulæ most commonly in use:

STAINING SOLUTIONS.

Dilute aqueous solution of eosin.

| | |
|--------------------------------|------------|
| Water-soluble eosin, - - - - - | 0.50 gram. |
| Distilled water, . - - - - | 300 c.c. |

Filter.

Solutions of fluorescein, aurantia, vesuvin (0.5 per cent.), etc., are prepared in a similar manner.

Böhmer's hæmatoxylin.

Make up the two following solutions :

| | |
|-------------------------------------|---------|
| (a) Hæmatoxylin crystals, - - - - - | 1 gram. |
| Absolute alcohol, - - - - - | 10 c.c. |

Pour the solution into a well-stoppered bottle.

| | |
|----------------------------|-----------|
| (b) Potash alum, - - - - - | 20 grams. |
| Distilled water, - - - - - | 200 c.c. |

Dissolve in the warm and filter when cool.

Allow to stand for 24 hours and then mix the two solutions *a* and *b*; leave the mixture exposed to the air for a week, then store in a well-stoppered bottle and filter immediately before use.

Hæmatein.

Prepare the two following solutions :

| | |
|-----------------------------|-----------|
| (a) Hæmatein, - - - - - | 1 gram. |
| Absolute alcohol, - - - - - | 50 c.c. |
| (b) Potash alum, - - - - - | 50 grams. |
| Distilled water, - - - - - | 1000 c.c. |

The potash alum is dissolved in the warm and added immediately to the hæmatein solution. Let the mixture cool in the air and then filter.

Orth's carmine.

| | |
|--|-------------|
| Saturated aqueous solution of carbonate of lithia, - - - | 100 c.c. |
| Carmine No. 40, - - - - - | 2.50 grams. |

Dissolve by trituration in a mortar in the cold.

Orth's alcohol carmine.

| | |
|---------------------------------|------------|
| Orth's carmine, - - - - - | 5 volumes. |
| 95 per cent. alcohol, - - - - - | 1 volume. |

Mix.

The latter solution only should be used for staining sections fixed with Mayer's albumin, as the former—the non-alcoholic solution—dissolves albumin.

Orth's picrocarmine.

Mix.

| | |
|--|--------------|
| Orth's carmine, - - - - - | 1 volume. |
| Saturated aqueous solution of picric acid, - - - - - | 1-2 volumes. |

After staining in the picrocarmine solution, the sections should be transferred to the following fixing solution :

| | |
|--|------------|
| Absolute alcohol, - - - - - | 70 c.c. |
| Saturated aqueous solution of picric acid, - - - - - | 30 " |
| Pure hydrochloric acid, - - - - - | 0.50 gram. |

(i) **Double staining.**

A. Method recommended.—1. Treat the section for about 30 seconds with the dilute solution of eosin (p. 218) until it acquires a pink colour.

2. Wash in distilled water.

3. Stain the section on the slide for about 30 seconds with carbol-gentian-violet or carbol-crystal-violet (p. 138). It now assumes a violet colour.

4. Pour off the violet and treat the section with Gram's iodine for 30 seconds or so, renewing the solution two or three times until the section is black. Wash in distilled water.

5. Wash with absolute alcohol (or absolute alcohol and aniline oil) until the pink colour of the ground-work reappears.

6. Clear with clove oil and xylol.

7. Mount in balsam.

The background is stained pink and those organisms which retain the stain by Gram's method are stained violet.

B. Kühne's method.—1. Stain the section for 5–15 minutes in Kühne's blue or ammoniacal blue.

2. Wash in distilled water.

3. Treat with Gram's solution for 2 or 3 minutes.

4. Wash in distilled water.

5. Decolourize in a saturated solution of fluorescein in absolute alcohol.

6. Treat with pure absolute alcohol, clove oil and xylol.

7. Mount in balsam.

Bacteria are stained blue while the ground-work is faintly stained with fluorescein.

(ii) **Triple staining.**

A. Method recommended.—1. Stain for about 5 minutes with Orth's picrocarmine.

2. Pour off the stain and fix in the fixing solution for about 30 seconds.

3. Wash in distilled water.

4. Stain with carbol-gentian-violet or carbol-crystal-violet for 30 seconds.

5. Replace the stain with Gram's solution for 30 seconds. Wash in distilled water.

6. Decolourize in absolute alcohol or absolute alcohol and aniline oil.

7. Treat the section in turn with absolute alcohol slightly tinted with picric acid, clove oil and xylol.

8. Mount in balsam.

B. Nicolle's method.—This method is applicable to sections fixed on the slide with Mayer's albumin.

1. Stain with Orth's alcohol-carmines for 15 minutes.

2. Wash in distilled water.

3. Stain in carbol-gentian-violet (p. 138) for 6 seconds.

4. Substitute Gram's strong solution (p. 209) for the gentian-violet and treat for 4 or 6 seconds, renewing the solution twice during the process.

5. Decolourize with alcohol-acetone (1 to 3).

6. Transfer to picric acid in absolute alcohol for a second or two.

7. Clear in clove oil and xylol.

8. Mount in balsam.

C. Claudius' method.—1. Fix the section on the slide with Mayer's albumin.

2. Stain for 10–15 minutes in Orth's alcohol-carmines.

3. Wash in distilled water.

4. Stain for 2 minutes in a 1 per cent. aqueous solution of methyl violet or in carbol-gentian-violet.

5. Treat for 2 minutes with picric acid solution (p. 144).
6. Blot up the picric solution carefully with filter paper and pour a large drop of chloroform over the section. Blot up the chloroform with filter paper and replace it with a drop of clove oil and repeat the process until the section assumes a pink colour.
7. Clear in xylol and mount in balsam.

2. Methods applicable to organisms in general.

A. Foa's method.—This method is particularly useful for the detection of the typhoid bacillus. It depends upon the use of a mixture of methyl-green and pyronin (**Pappenheim's solution**).

When this method of staining is to be used the tissue should not be fixed in alcohol but in the following solution:

| | |
|-------------------------|----------|
| Perchloride of mercury, | 2 grams. |
| Müller's fluid, | 100 c.c. |

Leave the tissue in this solution for 24–48 hours; wash in water for 2 hours; harden in alcohol (p. 188) and embed in paraffin.

1. Stain the sections for 5 minutes in the following mixture:

| | |
|---|--------------|
| Saturated aqueous solution of methyl-green (Grübler), | 3–4 volumes. |
| " " " pyronin, | 1–2 " |

2. Wash in running water. Blot up the excess.

3. Pass rapidly through absolute alcohol to xylol and mount in balsam.

The bacilli are stained red and the tissues of the section blue or violet.

B. Saathoff's method.—This is a modification of the preceding rendering the latter more convenient and yielding preparations which keep better. Alcohol may be used to fix the tissues.

1. Stain for about 4 minutes in the following solution which must be filtered before use:

| | |
|--|-------------------------|
| Methyl-green, | 0.15 gram. |
| Pyronin, | 0.5 " |
| 96 per cent. alcohol, | 5 grams. |
| Glycerin, | 20 " |
| 2 per cent. aqueous solution of carbolic acid, | <i>Q.S. ad</i> 100 c.c. |

2. Wash in running water until the green colour gives place to a bluish-red. Blot up the excess of water.

3. Dehydrate *very rapidly* in absolute alcohol. Wash in xylol. Mount in balsam.

CHAPTER XIV.

IMMUNITY.¹

THE PROPERTIES OF IMMUNE SERUMS.

Introduction.—The mechanism of immunity, p. 222.

Section I.—Prophylactic and therapeutic serums, p. 223.

Section II.—Antitoxins, p. 224.

Section III.—Agglutinins, p. 225.

The mechanism of agglutination, p. 226.

Section IV.—Bactericidal properties, p. 227.

The mechanism of bacteriolysis, p. 228. Hæmolysins, p. 230. The mechanism of hæmolysis, p. 231. The fixation of the complement, p. 232.

Section V.—Opsonins, p. 239.

IMMUNITY as the word is applied in bacteriology denotes the faculty possessed by a living animal of resisting an infection or intoxication.

Immunity to a particular organism or toxin may be natural or acquired.

Natural immunity is a function of the species and only rarely of the race. In some cases it has a relation to age: thus, adults may be immune while the young of the same species are susceptible to a particular infection or intoxication. Again immunity may be absolute or relative.

Acquired immunity to a specific disease may be a natural condition resulting from an attack of that disease; for instance, a person rarely suffers from more than one attack of enteric fever, measles or anthrax; or it may be a condition artificially produced in an individual in response to the inoculation of a virus, a toxin, or the serum of an immunized animal.

Immunity artificially produced may be active or passive.

Active immunity is the result of the inoculation of small doses of vigorous cultures of living organisms, of cultures of living organisms attenuated either by heat or by prolonged artificial cultivation, of dead organisms, or of the toxins which organisms produce. An active reaction takes place in the living tissues in response to the inoculation with the result that the subject has acquired certain new properties and these will have to be studied in detail. Active immunity is only acquired slowly and then at the cost of a real and occasionally serious disease during which the tissues may be highly susceptible to further inoculation of the particular virus; but on the other hand the

¹ It would obviously be beyond the scope of a book such as this to enter into a detailed study of immunity and the theories associated with it. The present chapter is therefore limited to such explanations as are indispensable to the proper understanding of the subsequent chapters and to an account of the principal methods of demonstrating the properties of immune serums.

immunity so acquired is lasting and occasionally absolute. By increasing the number of successive vaccinating inoculations the animal may in time become so highly immunized that even enormous doses of the specific organism or toxin have no visible effect upon it: this is a special condition of **hyper-immunization** in which the resistance of the animal is raised to its highest limits.

But if a non-immune subject be inoculated with the serum of an immunized or hyper-immunized animal instead of with organisms or toxins a different result ensues. The former is certainly rendered immune but in this case it is merely a condition of **passive immunity**. The person or animal passively immunized has taken no active part in the process of immunization but has simply been inoculated with something possessing prophylactic properties. The period during which such immunity lasts, which is always very short (generally a few days only), is dependent upon the time during which the substance inoculated remains in the tissues and as soon as it is eliminated the immunity has gone.

The mechanism of immunity.

If a living animal be immune against a pathogenic organism, the inoculation of that organism into the animal results in an aggregation of leucocytes at the site of inoculation (*chemiotaxis*) which ingest and digest the inoculated organisms. This is the phenomenon described by Metchnikoff as *phagocytosis*.

Phagocytosis can be easily observed, for instance, with the anthrax bacillus. If a healthy guinea-pig be inoculated with a trace of an anthrax culture the tissues about the site of inoculation soon become the seat of an oedematous infiltration (the oedema consists of a serous fluid containing free organisms but very few leucocytes): the bacillus quickly generalizes and death rapidly supervenes. On the other hand, if a guinea-pig previously vaccinated against anthrax be inoculated it can be shown that numbers of leucocytes very rapidly accumulate at the site of inoculation and in a few hours have ingested, killed and digested all the bacilli, the animal suffering no ill-effects from the inoculation. A similar observation can be made on dogs, animals naturally immune to anthrax. The inoculation of anthrax bacilli into dogs is followed by a small abscess in which phagocytosis is very active but the infection does not become generalized.¹

The leucocytes take up the micro-organisms while the latter are still living. Experiments have been devised to show that organisms ingested by leucocytes retain their vitality for a greater or lesser length of time during which they can, in a non-immune animal, set up a fatal infection (Metchnikoff).

On the other hand, in some cases, notably in the case of the cholera vibrio, it has been observed that if the vibrio be inoculated into the peritoneal cavity of an immunized guinea-pig it is killed not after ingestion by the leucocytes—which are present in very small numbers in the exudate—but in the exudate itself: this constitutes **Pfeiffer's phenomenon** (*vide infra*). Such a phenomenon might be quoted as an objection to the theory of phagocytosis but more extended observation shows bactericidal action of this nature by the body fluids to be exceptional: it may be described as a make-shift in the defence of the individual and only occurs when the leucocytes have undergone changes which prevent them coming in contact with the organisms themselves and is moreover only seen in the case of a few very delicate organisms.

¹ Micro-organisms have their own means of defence in their fight with the leucocytes: they secrete soluble substances, *agressins*, which act on the white cells of the blood and prevent them ingesting and destroying the infecting agents. In conditions of immunity the leucocytes triumph over these *agressins* and thus fulfil their function of defence.

According to Metchnikoff the bactericidal substances in the serum are derived from the leucocytes: some (*immune bodies, amoceptors, or sensibilisatrices*) are elaborated in the leucocytes and excreted into the plasma as they are formed, whence they pass into the different tissues of the animal; the others (*complement, cytase or alexin*) are also of leucocytic origin but are only set free on the death and disintegration of the leucocytes. Petterson and Schneider consider that there are yet other substances in the leucocytes capable of destroying micro-organisms (*endolysins, leukins*).

In the majority of cases the bactericidal substances of the serum of immunized animals intervene to prepare the micro-organisms for the action of the leucocytes and facilitate their ingestion and destruction (*vide opsonins*).

In immunized animals therefore over and above the phagocytic reaction there exist in the fluid part of the blood (serum) certain substances of great importance which play a prominent part in the phenomena of immunity. The properties of these immune serums will be now studied a little more fully.

The serums of immunized animals may exhibit one or more or all of the following properties each quite independently of the other and in different degrees.

1. Prophylactic and therapeutic properties.
2. Antitoxic properties.
3. Agglutinating properties.
4. Bactericidal properties.
5. The property of preparing micro-organisms for ingestion by the leucocytes. This property which is due to the presence of special substances, *opsonins*, would appear to be connected with the bactericidal properties.

SECTION I.—PROPHYLACTIC AND THERAPEUTIC SERUMS.

It has already been pointed out that the serum of an animal vaccinated against a micro-organism if inoculated into a fresh animal confers on the latter an immunity of short duration.

This passive immunization is absolutely *specific* and is only exhibited towards the species of organism with which the first animal was vaccinated.

The serum of an animal vaccinated with toxin if inoculated into a fresh animal confers on the latter an immunity against the same toxin and also against the micro-organism which elaborated the toxin.

Example.—If a normal guinea-pig be inoculated with antidiphtheria serum it is protected against the inoculation of diphtheria toxin and also against inoculation with the diphtheria bacillus.

On the other hand, if an animal be vaccinated with micro-organisms its serum has no protective action against the toxin of the organism though it protects against the organism itself.

Example.—The serum of an animal vaccinated with the cholera vibrio (*vide Cholera*) will protect a normal animal against an inoculation of the vibrio. A trace of the serum, for instance, inoculated into a normal guinea-pig will vaccinate the latter against choleraic peritonitis. On the other hand the serum affords no protection against an inoculation of the toxin and is totally ineffective in intestinal cholera which is an intoxication (Metchnikoff).

In all of the foregoing cases the serum acts as a prophylactic; that is to say, it immunizes the animal to which it is administered provided it be inoculated before or at the same time as the organisms or toxin.

Some serums exhibit therapeutic as well as prophylactic properties. If inoculated after the infection, even though the first symptoms of infection have appeared, they abort the disease and lead to recovery. The curative

properties of a serum do not always run parallel with its prophylactic properties. To quote a classical instance: antidiphtheria serum is both prophylactic and curative, but antitetanus serum while exhibiting very marked prophylactic properties has no curative properties. These properties of immune serums will be referred to again in more detail, each serum being dealt with in connexion with its corresponding organism.

SECTION II.—ANTITOXINS.

If an animal be inoculated with progressively increasing doses of a micro-organic toxin it will ultimately become immunized against this toxin, and will be able to tolerate without suffering any inconvenience doses infinitely greater than those which if given in the first instance would have proved fatal (Behring and Kitasato).

To this general rule there are however a few exceptions and these have been described by Richet as cases of **anaphylaxis**.

Richet showed that if a dog were inoculated with a small dose of actino-congestine (the poison in the tentacles of sea anemones) it exhibited no ill-effects; but if 10–20 days after the first inoculation it were re-inoculated with the same or even with a smaller dose than that which before proved harmless the animal quickly died. This result cannot be explained on the theory of an accumulation of toxin because the whole quantity given in the two doses is very much less than that which would be required to produce a fatal result if given in the first instance, and further if the second inoculation be given from 1–6 days after the first, the animal does not die: the phenomena of anaphylaxis do not appear until about the tenth day. The serum of an anaphylactic dog inoculated into a normal dog produces a condition of hypersensibility immediately after inoculation, and hence the serum of anaphylactic animals contains the substance—whatever its nature—causing the phenomena of anaphylaxis (Richet).

Other instances of anaphylaxis may be quoted. If an animal be inoculated once with the serum of another species it is only rarely and then inconstantly that any untoward symptoms develop, but if successive re-inoculations be made the result is quite different, the reaction on the part of the inoculated animal being then very violent and likely to terminate fatally (Arthus). This phenomenon is seen for example when rabbits or, better, guinea-pigs, are repeatedly inoculated with horse serum. According to von Pirquet and Schrick the grave symptoms occasionally observed in the human subject after injections of antidiphtheria serum are of an anaphylactic nature.

Anaphylaxis in connexion with tuberculosis has also been the subject of experimental observation. The reaction to tuberculin is an anaphylactic phenomenon: the inoculation of a trace of tuberculin into man or an animal affected with tuberculosis sets up a severe reaction (*vide* Tuberculosis) and numerous methods of diagnosis are based on this reaction.

Still further examples of anaphylaxis could be given but it must suffice here to have drawn attention to the existence of this phenomenon. To investigate the mechanism of anaphylaxis and to discuss the theories which have been advanced in explanation of it would be altogether beyond the scope of the present work.

The serum of animals which have survived the inoculation of repeated and increasing doses of toxin has acquired **antitoxic properties**.

Antitoxin, like toxin, has its nature altered by being heated, is precipitated by alcohol, and is carried down by precipitates formed in the liquid in which it is in solution. In suitable quantities it saturates toxin both in the tissues and *in vitro*. In mixtures *in vitro* toxin is not destroyed by antitoxin but is simply disguised; the toxin-antitoxin mixture is nevertheless harmless to animals, though under certain conditions the poisonous nature of the toxin may be made to reappear; thus, if a neutral mixture of snake venom and antivenomous serum be heated to 70° C. the antitoxin is destroyed but not the toxin so that the mixture is now no longer harmless.

Antitoxic serums are strictly specific. Under the head of each of the pathogenic micro-organisms the antitoxic properties of the corresponding serum will be considered in detail.

SECTION III.—AGGLUTININS.

Durham and Gruber when studying antityphoid serum demonstrated a very remarkable property of the serum. If a small quantity of serum from a typhoid-immunized animal be added to a broth culture of the typhoid bacillus the bacilli distributed through the medium lose their motility, collect together and become agglutinated into masses, retaining however their vitality. This phenomenon is known as *agglutination* and the serum is said to possess *agglutinating properties*.

Previously to Durham and Gruber's experiments, Bordet had demonstrated a similar action of anticholera serum on cholera vibrios, and it has since been shown that in the majority of cases the serum of an animal immunized against a micro-organism agglutinates the organism used for immunization (cholera, dysentery, tuberculosis, mediterranean fever, plague, glanders, etc.).

The property of agglutination however is not limited to the serum of immunized animals. [A. S. Grünbaum showed that] it appears quite early, before a state of immunity has been created, as soon as the tissues have been invaded by a pathogenic organism. The reaction of agglutination is a *reaction of infection*. It remains, moreover, for a long time after recovery has taken place, being found as has already been stated in a marked degree in the serum of immunized individuals.

The agglutination reaction is specific: the serum of an enteric patient agglutinates the typhoid bacillus and (with certain reservations) the typhoid bacillus only. The serum of cholera patients similarly agglutinates only the cholera vibrio.

[A. S. Grünbaum and shortly afterwards] Widal showed that practical use can be made of these facts in the diagnosis of infective diseases and to [the former] is due the method of *serum diagnosis*. Take, for example, the case of a person thought to be suffering from enteric fever: it is only necessary to mix a few drops of his serum with a culture of the typhoid bacillus: then if the patient be suffering from enteric fever the bacilli will be agglutinated; on the other hand, if he be suffering from some disease other than enteric fever the bacilli will remain separate and motile.

Conversely, suppose it is required to determine whether a bacillus is the typhoid bacillus or not: in this case it is sufficient to prepare a culture of the unknown bacillus and to mix it [in due proportion] with a typhoid-agglutinating serum: if agglutination take place the bacillus may without hesitation be affirmed to be the typhoid bacillus.

To obtain reliable results, there are certain precautions which must be strictly observed in carrying out the reaction. To exemplify: most normal serums—and especially human serums—when used in large quantities agglutinate a considerable number of organisms: if a mixture of serum and organisms be made without knowing the proportions in which they are mixed agglutination might be obtained apart from any specific relation of the ingredients to each other. The following rules should therefore always be followed:

(i) The serum under investigation must be diluted [Grünbaum] and the dilution carried to such a degree that the minimal dose of serum required for agglutination is determined. For purposes of comparison the minimum

quantity of normal serum (human or animal) required to produce agglutination must also be determined.

For example, it can be shown that while normal serum frequently agglutinates the typhoid bacillus in a dilution of 1 in 10 a typhoid serum will agglutinate it in dilutions of 1 in 200, 1 in 500, and even in 1 in 5,000.

(ii) It becomes even more imperative to dilute the serum when it is recognized that a specific serum will agglutinate not only its corresponding organism but also, not infrequently, closely related species, provided that the quantity of serum used be sufficient [Grünbaum]. It is obvious therefore that unless a serum be adequately diluted its specific characters will escape recognition.

Take an example: a patient is suffering from a para-typhoid infection. His serum agglutinates both the typhoid and the para-typhoid bacillus in dilutions of 1 in 20 and 1 in 50: so far there is nothing specific about the serum. Dilute the serum further, say to 1 in 100, 1 in 200, and 1 in 500. In these higher dilutions it has entirely lost all its agglutinating property for the typhoid bacillus but still agglutinates the para-typhoid bacillus. In this case the specific nature of the agglutination is determined by the *titre* of agglutination and not by the mere fact of agglutination itself.

(iii) It is also of the highest importance in studying the phenomena of agglutination that only homogeneous emulsions or cultures be used in which the organisms are as far as possible lying separately, for if they be clumped or massed together the results of the experiments will obviously be misleading. This spontaneous clumping is a source of great difficulty when working at agglutination with organisms which naturally grow in clumps. The difficulty may be overcome either by using very young cultures in broth (typhoid bacillus) or by having resort to one or other of the various methods which have been devised for obtaining homogeneous cultures (of the tubercle bacillus, etc.).

(iv) Finally, in performing agglutination tests with serums care must be taken to add the serum to the culture and never to add the culture to the serum. It can be easily understood that in the latter case the first drops of culture would be mixed with an undiluted serum and that agglutinated masses of organisms might form even though there were no specific relationship between the organism and the serum.

The technique of serum diagnosis will be described in detail in the chapter on the typhoid bacillus, and under the head of each micro-organism data with regard to agglutination will be given.

The mechanism of agglutination.

It would appear that the phenomena of agglutination are not dependent upon any vital activity of the organisms since they can be observed with dead cultures.

The substances in serums producing agglutination are known as *agglutinins*. Agglutinins are distinguishable from bactericidal substances in that unlike the latter they withstand heating at 55° C. for half an hour and are only destroyed at about 60° C. in serum and 70° or 80° C. in milk. They are precipitated by alcohol and do not pass through a Chamberland or Berkefeld bougie. But since they can be demonstrated in the milk, urine, etc., of infected or immunized animals it would appear that they can pass through certain living animal membranes.

The phenomena of agglutination may be explained on the assumption that the *agglutinin* acts on some *agglutinatable substance* present in the bodies of the organisms agglutinated. Organisms which have been separated from

the culture medium by filtration, washed and suspended in normal saline solution still retain the property of being agglutinated by a specific serum. But, as Kraus and Ch. Nicolle have shown, if a culture be filtered through porcelain a flocculent precipitate, similar to masses of agglutinated micro-organisms, forms on the addition of a specific serum to the filtrate. It is obvious therefore that the agglutinatable substance is also present in the culture fluid; it may be that as the organisms grow old the agglutinatable substance passes into the culture fluid. The name *precipitins* has been suggested for the substances in serum which cause the precipitate in filtered cultures: there is evidence that precipitins and agglutinins are identical bodies.

Finally, certain chemical substances have the property of agglutinating micro-organisms (Malvoz) but their action is in no way specific and the same substance will agglutinate different micro-organisms (Beco). A mixture of equal parts of commercial formalin, alcohol, hydrogen peroxide, a 1 in 1,000 solution of chrysoidin, vesuvin, safranin, or perchloride of mercury, etc., agglutinates the typhoid bacillus as well as various other organisms.

SECTION IV.—BACTERICIDAL PROPERTIES.

The fact that the serum of immunized animals has the power of destroying bacteria was brought to light by one of Pfeiffer's experiments which has since become classical.

Pfeiffer's experiment.—If a normal guinea-pig be inoculated in the peritoneal cavity with a broth culture of the cholera vibrio the animal rapidly succumbs from peritonitis, and if the peritoneal exudate be examined microscopically in a hanging-drop preparation it is found to contain very large numbers of free motile vibrios, exactly similar to those inoculated.

Let the same experiment be done on a guinea-pig which has been immunized against the cholera vibrio; the animal survives the inoculation and an examination of the peritoneal fluid reveals an entirely different condition.

In a drop of the fluid removed 10–30 minutes after the inoculation it will be found that not only have the vibrios not multiplied but they have also lost their motility, and instead of finding numerous elongated comma-shaped organisms as in the former case, the fluid is seen to contain small granules of no definite shape, which soon disappear altogether being destroyed in the fluid in which they are suspended.

This granular metamorphosis followed by complete destruction of the vibrio may also be demonstrated *in vitro* (Bordet, Metchnikoff).

Bordet's experiment.—Break up a small quantity of an agar culture of the cholera vibrio in a little sterile broth: examine the emulsion under a microscope to see that there are no granular forms and that the vibrios are quite motile: add to the emulsion $\frac{1}{20}$ – $\frac{1}{40}$ th of its volume of the serum of an immunized guinea-pig. On examining the mixture a few minutes after the addition of the serum, the vibrios will be seen to have lost their motility and to have become agglutinated and converted into granular dots: the reaction is however not at its maximum until the mixture has been kept at 37° C. for 1 or 2 hours.

From these two experiments it may be concluded that the serum of immunized guinea-pigs, apart from the intervention of any cellular element, contains bactericidal and bacteriolytic substances capable of destroying the cholera vibrio.

These substances are specific so that the serum is only bactericidal for the

organism with which the animal has been immunized. The serum of animals immunized with the typhoid bacillus for instance is bactericidal only for the typhoid bacillus and is totally devoid of action on the cholera vibrio, and, *vice versa*, an anticholera serum is not bactericidal for the typhoid bacillus.

The bactericidal action of immunized serums is rapid and at its maximum at 37° C., feeble at the ordinary temperature of the laboratory and altogether paralyzed at 0° C.

The analysis of the phenomena of **bacteriolysis** may now be pushed a step further and an attempt made to investigate the mechanism by which bacteriolysis occurs.

Mechanism of bacteriolysis.

Suppose the serum of a guinea-pig immunized with the cholera vibrio be heated to 55° C. and then mixed with a culture of the vibrio. Bacteriolysis no longer takes place, though the agglutinating properties of the serum remain unaffected (Bordet).

The heated serum, however, has not altogether lost its bactericidal properties; for, if to the mixture of vibrios and heated serum a small quantity of serum from a normal animal be added, bacteriolysis occurs at once—the heated serum is *re-activated*.

It may therefore be concluded that the serum of the immunized animal contains two substances :

(i) One of which is not destroyed by being heated at 55° C. or, in other words is **thermostable** at 55° C. and which is only present in the serum of immunized animals.

(ii) The other of which is destroyed by heating to 55° C. or, in other words, is **thermolabile** at 55° C. and which is present also in the serum of normal animals.

These two substances when present together cause bacteriolysis but either the one or the other acting alone has no action on the vibrio. Let us consider now the part which each of these substances plays.

A. Immune body (*Sensibilisatrice*).—The thermostable substance is, as has been said, present only in the serum of immunized animals and is a *product of immunization* [hence the term immune body generally used in England]. And, further, it is *specific* and acts only on the organism which was used for immunization.

Experiment.—Treat an emulsion of cholera vibrios with anticholera serum heated to 55° C. and then add a little normal rabbit serum. The vibrios will be bacteriolysed.

Repeat the experiment using instead of cholera vibrios, typhoid bacilli. Treat the typhoid bacilli with heated (55° C.) anticholera serum and then add the normal rabbit serum. No bacteriolysis takes place.

The immune body in contact with its corresponding micro-organism is fixed by the organism in the same way that a mordant acts on a fabric.

Experiment.—Leave a mixture of cholera vibrios and heated anticholera serum for half an hour at 37° C. Centrifuge to separate the vibrios, wash the latter with normal saline solution and then add a little fresh normal rabbit serum to the vibrios. Bacteriolysis takes place.

This experiment justifies the view held by Bordet that the immune body sensitizes the organisms to the action of the thermolabile substance present in normal serum just as a mordant sensitizes a fabric to the action of a dye. Hence the use in France of the word *Sensibilisatrice* to denote the immune body. The immune body is only destroyed by heating it at 65°–70° C.

Sensitized micro-organisms, that is to say, organisms which have been

treated with their specific immune body, continue to grow in the ordinary way and have lost none of their pathogenic properties, but they differ from non-sensitized organisms not only in their susceptibility to the action of the thermolabile substance or complement (*vide infra*) present in all normal serums, but also in that they are more easily ingested and destroyed by leucocytes.

The immune body is known by different names, *substance sensibilisatrice* (Bordet), *fixateur*, *amboceptor* (Ehrlich). Occasionally it is described as

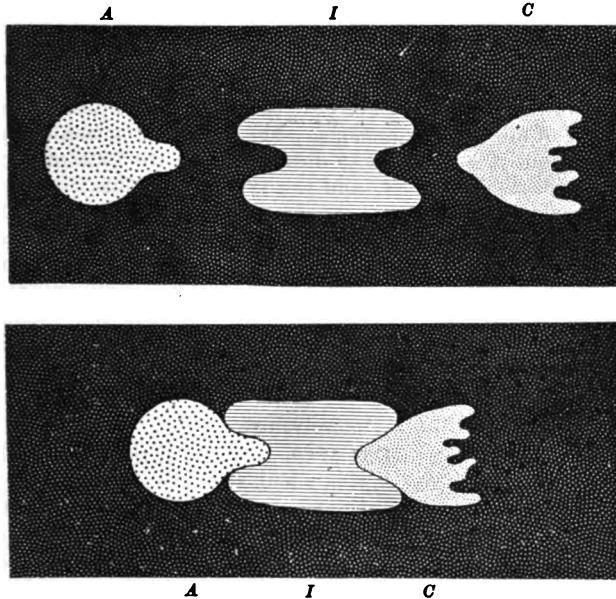

FIG. 159.—Ehrlich's diagram to explain the interaction between the immune body and complement.

A, micro-organism or antigen; I, immune body, sensibilisatrice, amboceptor, fixateur or antibody; C, complement, alexin or cytase.

the **antibody** because it is antagonistic to the substances inoculated into animals for the purpose of immunizing them. These latter substances are therefore called **antigens**. Thus, in immunizing animals against the typhoid bacillus the antigen is the typhoid bacillus and the antibody the new product appearing in the serum in response to the inoculation of the antigen and which has the property of attaching itself to the typhoid bacillus and so of rendering the bacillus susceptible to bacteriolysis.

B. Complement.—The immune body prepares organisms for the action of the substance contained in the serum of normal animals. This latter substance in conjunction with the immune body produces bacteriolysis, hence the name *complement* by which it is generally described (Ehrlich). By some authors, however, it is occasionally referred to as *alexin* (Bordet) or *cytase* (Metchnikoff and Buchner).

The complement is not a product of immunization and is not specific but is present in all normal serums and is fixed indifferently by all organisms through their specific immune body.

When complement is mixed with micro-organisms it is only taken up by them if they have been sensitized. Complement has no affinity for non-

sensitized organisms and remains in the serum. Its action is like that of a dye which only dyes a fabric that has been treated with a mordant.

To sum up : in the serum of immunized animals a specific substance, the immune body, is present which unites on the one hand with its corresponding micro-organism and on the other hand with a substance, alexin or complement, pre-existing in the serum of all normal animals. Upon this interaction of two bodies, in which the immune body plays a part similar to that of a mordant in dyeing, depends the destruction of the micro-organisms in Pfeiffer's experiment.

The interaction of complement with the micro-organism through the immune body is diagrammatically represented in the figure (fig. 159).

Note.—It is important to observe that the phenomena just studied are not seen in the case of all micro-organisms. The combined action of the immune body and complement only leads to destruction in the case of very delicate organisms, *e.g.* the cholera vibrio and the typhoid bacillus.

In the majority of cases the pathogenic micro-organisms are much more resistant to the bactericidal action of the immune serums and no bactericidal action can be seen ; but though not visible, combination of the immune body with the complement nevertheless takes place, and the organisms are rendered more easy of destruction by the leucocytes (*vide* opsonins).

In studying the phenomena of complement fixation (*vide infra*) it will be shown how the action of the immune body on the more resistant organisms may be demonstrated.

Hæmolysins.

Hæmolysis means the destruction of the red cells of the blood with diffusion of the hæmoglobin into the medium in which they are suspended.

If a quantity of red cells be suspended in an hypotonic solution, distilled water for example, they undergo hæmolysis. On the other hand, in an isotonic fluid, normal saline solution for instance, the red cells may remain intact for a very long time. Similarly in the serum of the majority of normal animals the red cells undergo no alteration. To this general rule, however, there are a few exceptions ; dogs' serum, for instance, hæmolyses guinea-pig red cells ; eel serum hæmolyses all mammalian red cells, and so on.

The inoculation of large doses of red cells of one species of animal into the peritoneal cavity of another species produces a toxic effect and may kill the animal inoculated.

On the other hand, if small quantities be inoculated on several successive occasions there is a minimal reaction and death does not take place. In the latter case the serum of the inoculated animal is capable of destroying the red cells of the animal species used for inoculation *in vitro* and is therefore said to exhibit hæmolytic properties (Bordet).

For example, if a guinea-pig be inoculated with rabbit red cells, the guinea-pig's serum will become hæmolytic for rabbit red cells.

Preparation of an hæmolytic serum.—Under no conditions must the whole blood be inoculated but only the washed red cells.

1. Collect some blood under aseptic precautions, and after defibrinating it (p. 36) centrifuge. Thus, into each tube of the centrifuge pour equal parts of defibrinated blood and sterile normal saline solution, centrifuge, and when the red cells are all precipitated at the bottom of the tube pipette off the clear supernatant liquid with a bulb pipette. Fill up the tube with fresh saline solution, stir up the deposit and centrifuge again. Repeat the operation three times.

After centrifuging for the third time dilute the red cells with sufficient sterile normal saline solution to bring the total volume up to the volume of blood originally used.

It is perhaps unnecessary to say that these operations should be carried out under aseptic conditions.

2. Inoculate the animal (a guinea-pig if using rabbit cells, a rabbit for sheep cells, etc.) sub-cutaneously, or better into the peritoneal cavity, on five occasions at intervals of 1 week with 5-8 c.c. of a suspension of red cells prepared as described above. Experience has shown that this amount does not produce any toxic symptoms. The serum of the animal is best collected about 1 week after the last immunizing inoculation.

Mechanism of hæmolysis.

The phenomena of hæmolysis are a counterpart of those of bacteriolysis.

The hæmolytic serum is specific and only hæmolyses red cells of the animal species used for inoculating the animal from which the serum has been drawn.

It contains two substances :

1. A specific thermostable immune body.
2. A complement, non-specific, present in all normal serums and only becoming attached to the red cells through the immune body. The properties of hæmolytic serums can be demonstrated by means of the following experiments.

Experimental illustrations.—Use the serum of a guinea-pig inoculated with rabbit red cells as an hæmolytic serum and prepare an emulsion of red cells by mixing 0.1 c.c. of washed rabbit red cells with 2 c.c. of normal saline solution.

(i) Mix the emulsion of red cells with 0.1 c.c. of the hæmolytic serum and incubate at 37° C. for 1 hour. On taking the tube out of the incubator it will be seen by simply looking at the tube that hæmolysis is complete : the hæmoglobin has been discharged from the red cells and imparts an uniform colour to the solution.

A control tube in which a little normal guinea-pig serum has been added to an emulsion of red cells shows no hæmolysis ; the fluid contents are clear.

(ii) To an emulsion of red cells, add 0.1 c.c. of hæmolytic serum previously heated to 55° C. for half an hour and incubate at 37° C.

The red cells are not hæmolysed but simply agglutinated at the bottom of the tube. In this case hæmolysis has failed because the complement was destroyed by heating the serum to 55° C.

(iii) To the mixture used in the preceding experiment and which is quite clear add 0.1 c.c. of normal guinea-pig serum (complement) and incubate again. The red cells will now undergo hæmolysis.

(iv) Repeat experiment (ii) and after showing that under the conditions of the experiment no hæmolysis occurs, centrifuge the mixture and pipette off the serum from the red cells.

(a) The centrifuged serum has been deprived of its immune body (which has combined with the red cells) and any attempt to re-activate it by the addition of complement (normal guinea-pig serum) fails ; it is no longer able to hæmolysed fresh rabbit cells if these be added to it.

(b) The red cells separated from the serum by centrifuging have combined with the immune body ; so that even after being repeatedly washed with normal saline solution and centrifuged, they are rapidly hæmolysed on the addition of 0.1 c.c. of normal guinea-pig serum (complement) if a mixture of the two be put in the incubator at 37° C.

(v) If the foregoing experiment be repeated and instead of rabbit cells, red cells of some other animal, sheep, for instance, be added to the heated hæmolytic serum it can be shown that the sheep cells are not sensitized, since on the addition of complement they are not hæmolyzed.

And further, the serum to which the sheep cells have been added has retained intact its sensitizing properties and is still capable of sensitizing rabbit red cells.

This experiment again demonstrates the specific nature of the reaction.

(vi) Hæmolysis does not occur at 0° C. Place a mixture of non-heated hæmolytic serum and a suspension of the corresponding red cells in the ice chest for several hours, then centrifuge the mixture and wash the cells in the cold, add some complement to the cells and incubate at 37° C. : hæmolysis occurs. Add the serum to some sensitized and washed red cells and in this case also hæmolysis occurs. In other words the immune body has been taken out of the serum by the red cells but at the temperature of the experiment the complement remains in solution.

Conclusions.

When a living animal is treated with sublethal doses of micro-organisms or their toxins (antigen) a substance inimical to the antigen (antibody, amboceptor, sensibilisatrice, immune body) appears in the serum which has the property of combining with the antigen, thus rendering the latter susceptible to the action of a third substance (complement, alexin, cytase) already present in the serum of the normal animal and derived probably from the leucocytes.

By the combined action of the immune body and complement, the antigen is either destroyed (in the case of red cells or delicate organisms) or prepared for the destructive action of the leucocytes (as happens with micro-organisms in general).

The fixation of the complement.

(Deviation of the complement.)

Prepare in accordance with the rules elaborated in the preceding paragraphs the following experiment.

Mix in suitable proportions a portion of a culture of the cholera vibrio and some anticholera serum previously heated at 55° C., incubate for 1 hour, and then add a small quantity of non-heated serum (complement) to the mixture. Under these conditions the vibrios sensitized by the specific immune serum are bacteriolized by the action of the complement. Now add to the mixture some red cells sensitized with their corresponding inactivated immune serum (*hæmolytic couple*); no hæmolysis takes place because there is no complement available, the complement originally present having all been used up in producing bacteriolysis of the cholera vibrios. In other words there has been *fixation, or deviation, of the complement* by the sensitized vibrios.

Now perform a second experiment. Mix a portion of a culture of the typhoid bacillus with some inactivated anticholera immune serum and after incubating, add a small quantity of guinea-pig complement. In this case, the immune body has not been able to sensitize the bacilli being specific for and combining only with cholera vibrios: consequently, the complement remains unattached, in other words, is not deviated. Now add some sensitized red cells to the mixture and incubate again; hæmolysis of the red cells occurs because there was free complement in the mixture with which they were able to combine.

From this fundamental experiment Bordet and Gengou deduced a very

valuable method of diagnosis for infective diseases which is known as the Bordet-Gengou or *complement-fixation reaction*. The reaction has been applied by Widal and Le Sourd to the diagnosis of enteric fever (fixation reaction, hæmolyso-diagnosis) and is applicable to the majority of micro-organic diseases. Two different cases arise for consideration.

First case.—Given a serum suspected to contain a particular immune body, the serum of an enteric fever patient, for example, a certain diagnosis may be made by the complement-fixation method.

Heat the serum to 55° C. for half an hour, prepare a mixture of typhoid bacilli and the heated serum, add some complement and incubate the mixture at 37° C. for an hour. Then add a mixture of red cells and homologous inactivated hæmolytic serum and incubate again. One of two things may happen.

1. Either the typhoid bacillus is sensitized by the inactivated suspected serum, in which case it fixes the complement so that on the addition of sensitized red cells—there being no free complement—the cells do not undergo hæmolysis. If this takes place it may be affirmed that the suspected serum contains antibodies for the typhoid bacillus and that the patient is suffering from enteric fever.

2. Or the typhoid bacillus is not sensitized by the suspected serum and therefore does not combine with the complement, so that on the addition of sensitized red cells the free complement attaches itself to them and hæmolysis is the result. The suspected serum, therefore, in this case contains no typhoid antibodies.

Second case.—Suppose a given organism is believed to be the typhoid bacillus and it is desired to confirm the diagnosis.

Prepare a mixture containing the suspected bacillus, heated antityphoid serum and complement. Incubate for an hour and then add a mixture of red cells and inactivated hæmolytic serum.

1. The bacillus may be sensitized by the antityphoid serum in which case it will absorb the complement, and on the addition of sensitized red cells—there being no free complement—no hæmolysis takes place; the complement was deviated or fixed by the suspected bacillus which is therefore the true typhoid bacillus.

2. The bacillus may not be sensitized by the antityphoid serum consequently it cannot fix the complement and this remaining in solution is free to combine with the sensitized red cells. There had been no fixation of the complement so hæmolysis occurs; the bacillus therefore, not uniting with the antityphoid immune body, is not the typhoid bacillus.

The value of this method of diagnosis to the bacteriologist can be easily appreciated: the results are more constant and more delicate than those obtained by means of agglutination tests but considerable technical skill is required in carrying out the reaction.

Technique of the complement-fixation reaction.

The following materials are required:

Apparatus, etc.—1. A number of narrow test-tubes about 10 cm. long and 5 c.c. capacity.

2. A number of 1 c.c. pipettes graduated in tenths of a cubic centimetre. (Levaditi's pattern is, perhaps, the best (fig. 160).)

The various manipulations should as far as possible be conducted under aseptic conditions, so that the tubes and pipettes must be sterilized in the hot air sterilizer.

3. Sterile normal saline solution. The volume of fluid in each tube used in the test should, if the experiment is to be conclusive, be the same. After the various ingredients have been added sufficient normal saline solution is poured in to bring the volume up to, generally, 2 c.c.

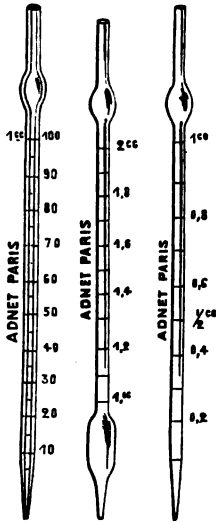

FIG. 160.—Levaditi's pipettes.

Red cells.—Sheep or rabbit red cells are generally used. They must be separated and washed in the manner already described (p. 230).

After the third washing prepare a 5 per cent. solution of the cells in normal saline solution.

Hæmolytic serum.—The method of preparing hæmolytic serums has been described above (p. 230). If sheep cells are used as the indicator the serum of a rabbit inoculated with sheep cells is employed, and for rabbit cells the serum of a guinea-pig inoculated with rabbit cells.

After collecting the blood in the ordinary way (Chap. XII.) the serum is decanted and then inactivated by heating for half an hour at 55° C. in sealed ampoules. The hæmolytic serum should be stored in an ice chest and it will then retain its hæmolytic properties for several months.

It is absolutely necessary to titrate the hæmolytic serum. This can be done in the manner indicated in the following table. In a series of tubes prepare the mixtures shown in the horizontal lines, incubate at 37° C. for 15–30 minutes and note the results.

| | 5% emulsion of red cells. | Heated hæmolytic serum. | Complement or alexin. | Normal saline solution (to make up to 2 c.c.). | Results. |
|----------------|---------------------------|-------------------------|-----------------------|--|--|
| Tube No. 1, - | 1 | 0.5 | 0.1 | 0.4 | Total hæmolysis in 15 minutes. |
| Tube No. 2, - | 1 | 0.3 | 0.1 | 0.6 | Total hæmolysis in 15 minutes. |
| Tube No. 3, - | 1 | 0.1 | 0.1 | 0.8 | Partial hæmolysis in 15 minutes, complete in 30 minutes. |
| Tube No. 4, - | 1 | 0.05 | 0.1 | 0.85 | Incomplete hæmolysis |
| Tube No. 5, - | 1 | 0.01 | 0.1 | 0.9 | Very slight hæmolysis. |
| Control No. 1, | 1 | — | 0.1 | 0.9 | No hæmolysis. |
| Control No. 2, | 1 | 0.5 | — | 0.5 | No hæmolysis. |

From an examination of the table it follows that the amount of hæmolytic serum added to tube No. 3 will, in this particular instance, be the most suitable for subsequent experiments: in this tube hæmolysis is complete in half an hour. Tubes Nos. 1 and 2 contain too much serum, and in Nos. 4 and 5 hæmolysis is not complete and they therefore contain too little serum.

Further, examination of the control tubes shows:

1. That the heated hæmolytic serum only hæmolyses when complement is added.

2. That complement alone does not hæmolysize the red cells.

In carrying out the reaction of complement fixation then, the quantity of 0.1 c.c. of this particular hæmolytic serum per 1 c.c. of the dilution of red cells will be used.

Complement.—Normal guinea-pig serum collected aseptically will be used as complement. The amount of complement to be added is of the greatest importance: if there be an excess of complement the whole of it will not be absorbed by the antigen-antibody mixture and the excess remaining in solution will hæmolysize the red cell-serum mixture and give an erroneous result. The smallest quantity of guinea-pig serum which will hæmolysize 1 c.c. of the sensitized red cell emulsion must therefore be determined.

If fresh guinea-pig serum be used it will be found to be very rich in complement but the amount rapidly diminishes in the first few hours. It is preferable therefore to use serum collected 8–10 days before [and stored in an ice chest]; it is not so active but its titre remains constant for several days (Nicolle and Pozerski). The following table illustrates the method of titration. Incubate the tubes for half an hour at 37° C. and then note the results.

| | 5% emulsion of red cells in normal saline solution. | Heated hæmolytic serum. | Complement (normal guinea-pig serum 8 days old). | Normal saline solution to make up to 2 c.c. | Results. |
|---------------|---|-------------------------|--|---|-------------------------|
| Tube No. 1, - | 1 | 0.1 | 0.2 | 0.7 | } Complete hæmolysis. |
| Tube No. 2, - | 1 | 0.1 | 0.1 | 0.8 | |
| Tube No. 3, - | 1 | 0.1 | 0.05 | 0.85 | |
| Tube No. 4, - | 1 | 0.1 | 0.03 | 0.9 | } Incomplete hæmolysis. |
| Tube No. 5, - | 1 | 0.1 | 0.02 | 0.9 | |

Tubes Nos. 1, 2 and 3 alone contain enough complement to produce complete hæmolysis. The quantity in tube 3 will be used because it is the smallest quantity which produces complete hæmolysis.

Antigen.—The organisms to be used as antigen should be prepared as follows: Take a young agar culture (in the case of the cholera vibrio or typhoid bacillus, for instance, a 24 or 48-hour culture) and emulsify one loopful in 2 c.c. of sterile normal saline solution. In carrying out the experiment small quantities only of this emulsion are used because large quantities of albuminoid substances may produce, in the absence of a specific reaction, a mechanical deviation of the complement and so give fallacious results.

The bacillary emulsion should be titrated by placing in the incubator at 37° C. a series of tubes containing progressively increasing quantities of the emulsion, an hæmolytic couple (p. 232) and some complement.

| | Emulsion of organisms. | Complement. | Emulsion of red cells. | Heated hæmolytic serum. | Normal saline solution. | Results. |
|-------------|------------------------|-------------|------------------------|-------------------------|-------------------------|-------------------------|
| | c.c. | c.c. | c.c. | c.c. | c.c. | |
| Tube No. 1, | 0·05 | 0·05 | 1 | 0·1 | 0·80 | } Complete hæmolysis. |
| Tube No. 2, | 0·1 | 0·05 | 1 | 0·1 | 0·75 | |
| Tube No. 3, | 0·2 | 0·05 | 1 | 0·1 | 0·65 | |
| Tube No. 4, | 0·3 | 0·05 | 1 | 0·1 | 0·55 | |
| Tube No. 5, | 0·4 | 0·05 | 1 | 0·1 | 0·45 | } Incomplete hæmolysis. |
| Tube No. 6, | 0·5 | 0·05 | 1 | 0·1 | 0·35 | |

Examination of the table shows that the quantity of bacterial emulsion to be used must be the amount contained in tube 3 or tube 4, namely 0·2 or 0·3 c.c. these being the maximum doses which do not prevent hæmolysis taking place.

In the serum diagnosis of syphilis, as it is not possible to obtain a culture of the treponeme, various other substances are used as the antigen, *e.g.* an extract of the liver of a syphilitic foetus. This will be referred to later (*vide* Chap. LIV.).

Bacteriolytic serums.—Bacteriolytic serums are obtained either from immunized animals or from man. A small quantity of blood—4 to 5 c.c.—is sufficient and may be obtained in the case of the human subject by puncture of a vein at the bend of the elbow or with the aid of a Bier's cupping glass; in the case of the rabbit by puncturing an ear vein (p. 194). After being collected the blood is put aside for a few hours, and the serum is then pipetted off and heated in sealed tubes at 55° C. for half an hour to destroy the complement. In carrying out the experiment the bacteriolytic serum should be added to the emulsion of bacteria in sufficient quantity to sensitize them but the actual amount required for sensitization should not be greatly exceeded for fear of introducing errors. The serum can be titrated by a method similar to that used for titrating the antigen (*vide ante*).

Experimental details.—The reagents being prepared, assume that it is desired to determine whether a given vibrio is the cholera vibrio or not. The experiment will be carried out as shown in the table on p. 237.

In this experiment no hæmolysis has taken place in the tubes Nos. 2, 3, 4: therefore the vibrio under investigation was sensitized by the cholera immune serum and was able to combine with the complement. The organism, therefore, is the cholera vibrio.

In tube No. 1 the quantity of vibrio emulsion was not quite sufficient, and this is the reason why the fixation has not been complete.

Examination of the control tubes confirms the diagnosis by proving that in the absence of anticholera serum in one case and in the absence of the cholera vibrio in the other no fixation has occurred, and therefore the tubes show hæmolysis.

If, however, the results had been as follows :

Tubes Nos. 1, 2, and 3 = complete hæmolysis.

Tube No. 4 = slight hæmolysis.

it would have been concluded that the vibrio had not been sensitized by the cholera immune serum ; that consequently there was no fixation of the complement ; and that therefore the vibrio could not have been the cholera vibrio. The assumed occurrence of partial hæmolysis in tube No. 4 is to be explained as due to a slight excess of bacterial emulsion ; the micro-organisms alone having absorbed some of the complement in the manner already described (p. 235).

DETAILS OF A COMPLEMENT-FIXATION EXPERIMENT AS ARRANGED FOR THE IDENTIFICATION OF A SUSPECTED CHOLERA VIBRIO (see p. 236).

| | (i) Mix and incubate for one hour at 37° C. | | | | (ii) Add at the end of the hour and incubate again for half an hour at 37° C. | | Results. |
|-------------|---|----------------------------|--------------|-------------------------|---|-------------------------|-----------------------|
| | Emulsion of vibrios. | Heated anti-cholera serum. | Complement. | Normal saline solution. | Emulsion of red cells. | Heated hæmolytic serum. | |
| Tube No. 1, | c.c. 0·1 | c.c. 0·1 | c.c. 0·05 | c.c. 0·65 | c.c. 1 | c.c. 0·1 | } Slight hæmolysis. |
| Tube No. 2, | 0·2 | 0·1 | 0·05 | 0·55 | 1 | 0·1 | |
| Tube No. 3, | 0·3 | 0·1 | 0·05 | 0·45 | 1 | 0·1 | } No hæmolysis. |
| Tube No. 4, | 0·4 | 0·1 | 0·05 | 0·35 | 1 | 0·1 | |
| Control, - | 0·1 | — | 0·05 | 0·75 | 1 | 0·1 | } Complete hæmolysis. |
| Control, - | 0·2 | — | 0·05 | 0·65 | 1 | 0·1 | |
| Control, - | — | 0·1 | 0·05 | 0·75 | 1 | 0·1 | } Complete hæmolysis. |
| Control, - | — | — | 0·1 | 0·80 | 1 | 0·1 | } Complete hæmolysis. |

To put the result beyond all doubt it is still necessary to show :

1. That the cholera serum in the quantity in which it was used does not fix the complement in presence of any other species of bacterium, and in an actual experiment an additional control tube would have been introduced containing instead of the vibrio emulsion an emulsion of, for instance, the typhoid bacillus. Hæmolysis should, of course, occur under these conditions.

2. That the vibrio under investigation does not fix the complement in presence of another serum. Another control tube would therefore be prepared with the emulsion of the vibrio but substituting, for example, an antityphoid serum for the anticholera serum. Here again hæmolysis should take place.

The above then is the method of applying the complement fixation reaction to the identification of an unknown organism. The data can be reversed

and the reaction applied to determine whether a given serum contains antibodies for a given organism. In illustration, an example will now be given to show how to determine whether or no the serum of a patient contain typhoid antibodies (hæmolyso-reaction of Widal and Le Sourd).

In this case the suspected serum after heating at 55° C. is mixed with a known typhoid bacillus and complement. The experiment is arranged in the same way as in the preceding experiment.

DETAILS OF A COMPLEMENT-FIXATION EXPERIMENT AS ARRANGED FOR THE IDENTIFICATION OF A SUSPECTED ENTERIC SERUM.

| | (i) Mix and incubate for one hour at 37° C. | | | | (ii) Add at the end of the hour and incubate again for half an hour at 37° C. | | Results. |
|-------------|---|----------------------------|--------------|-------------------------|---|-------------------------|----------------------------|
| | Emulsion of typhoid bacilli. | Heated suspected serum. | Complement. | Normal saline solution. | Emulsion of red cells. | Heated hæmolytic serum. | |
| Tube No. 1, | c.c. 0·2 | c.c. 0·1 | c.c. 0·05 | c.c. 0·55 | c.c. 1 | c.c. 0·1 | } No hæmo-lysis. |
| Tube No. 2, | 0·3 | 0·3 | 0·05 | 0·25 | 1 | 0·1 | |
| Control, - | 0·3 | Normal human serum. 0·3 | 0·05 | 0·25 | 1 | 0·1 | } Complete hæmoly- sis. |
| Control, - | 0·3 | — | 0·05 | 0·55 | 1 | 0·1 | } Complete hæmoly- sis. |
| Control, - | — | — | 0·05 | 0·85 | 1 | 0·1 | } Complete hæmoly- sis. |

In tubes Nos. 1, and 2 no hæmolysis has occurred; the typhoid bacillus it is evident has been sensitized by the serum under examination, which must therefore have come from a patient infected with the typhoid bacillus.

Examination of the control tubes shows that the bacillus alone or in presence of normal human serum is unable to fix the complement with the result that hæmolysis has taken place.

If, on the other hand, the serum under investigation had not sensitized the typhoid bacillus hæmolysis would have occurred, and the inference would have been that the serum contained no typhoid antibodies.

Practical applications.

The method of complement fixation has been applied to the diagnosis of a large number of micro-organic diseases (enteric fever, cholera, dysentery, tuberculosis, etc.) and to the identification of most micro-organisms. It is also the basis of **Wassermann's reaction** in syphilis which will be considered later (Chap. LIV.).

SECTION V.—OPSONINS.

In studying the bactericidal properties of serums it has been mentioned that many micro-organisms resist, *in vitro*, the combined action of immune body and complement, but that in the tissues once impregnated with these substances they more readily become the prey of the phagocytes (Metchnikoff).

Wright and Douglas have shown that in the serum of persons convalescent from infectious diseases or vaccinated against these diseases substances are present which prepare micro-organisms for the action of the phagocytes. Without committing themselves to an expression of opinion as to the nature of these substances Wright and Douglas describe them as opsonins ($\delta\psi\omega\nu\acute{\epsilon}\omega$ I prepare). Neufeld has applied to them the name *Bacteriotropins*.

According to Wright, opsonins play a fundamental part in the phenomena of immunity: he affirms that it is to opsonins that phagocytosis is due and that by means of the opsonic index of the serum it is possible to measure the immunity of the individual and foresee recovery.

Metchnikoff has observed that, as a matter of fact, the ingestion of micro-organisms by phagocytes rendered possible by the intervention of opsonins is only one factor in the problem. Ingestion is only of use in so far as it is followed by destruction and digestion of the organisms. But micro-organisms are not destroyed by leucocytes unless the latter contain bactericidal substances or in other words unless the leucocytes are "living and strong." Resistant micro-organisms may live for a long time in insufficiently active leucocytes without setting up disease but when such leucocytes are destroyed the micro-organisms are set free and exhibit their powers of producing disease. A notable instance of this is seen in the case of the spores of the tetanus bacillus (Chap. XXXVI.). The opsonic content of the serum is not therefore—at any rate in all cases—a sufficient datum upon which to evaluate the degree of resistance of the tissues.

However that may be, opsonins are of sufficient interest in the study of micro-organic diseases and immunizing processes to merit some detailed consideration.

To determine the opsonic content of a given serum for a particular micro-organism, the serum and a culture of the organism are mixed with normal leucocytes and after an interval the average number of micro-organisms ingested by each leucocyte under these conditions calculated. The number of organisms ingested by 50 leucocytes is counted and the total divided by 50 gives the *opsonic power* of the serum.

It is obvious, of course, that the number of organisms phagocytosed will depend upon the number of bacteria present in a unit volume of the emulsion. The absolute number obtained—*i.e.* the opsonic power—is therefore of no value in itself, but if this number be compared with the number which represents the opsonic power of a normal serum determined under the same conditions with the same bacterial emulsion then a standard of comparison is obtained; and the relation of the opsonic power of the serum of an infected individual to that of a normal individual (measured under identical conditions) is known as the *opsonic index*.

The amount of opsonin present in the serum of normal individuals is subject to considerable variation and is dependent upon many factors, *e.g.* the period which has elapsed since food was last taken, pregnancy, etc. (Milhit).

The amount of specific opsonin in the serum of infected persons shows very curious variation. In tuberculosis, for example, if the opsonic index of normal blood for the tubercle bacillus be taken to be about unity that of infected persons is much lower, and a condition of tuberculosis may be diagnosed in every case in which the opsonic index falls below unity (0.3 to 0.8), provided that the experiment be done several times and the same result is obtained

on every occasion. The reaction is much more reliable in the "surgical tuberculosés" than in pulmonary tuberculosis.

In suspected cases of enteric fever an opsonic index above 1·7 for the typhoid bacillus affords strong presumptive evidence in favour of enteric fever (Milhit). Similarly in cerebro-spinal meningitis the opsonic index is raised above normal during the course of the disease ; and so on.

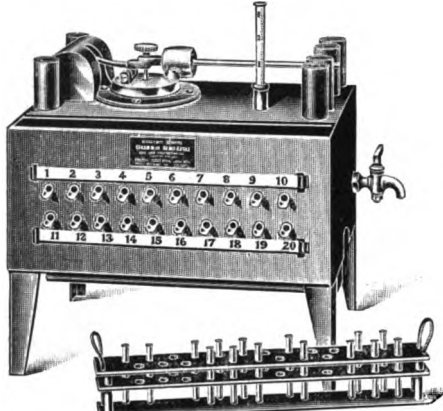

FIG. 161.—Opsonic incubator.

A supply of sterile normal saline solution and of citrated saline solution must be at hand :—

| | | | | | | | | | | |
|------------------|---|---|---|---|---|---|---|---|---|-------------------------|
| Sodium chloride, | - | - | - | - | - | - | - | - | - | 8·5 grams. |
| Sodium citrate, | - | - | - | - | - | - | - | - | - | 15 |
| Distilled water, | - | - | - | - | - | - | - | - | - | <i>Q.S. ad</i> 1 litre. |

Normal serum.—Collect some blood in a small centrifuge tube either from an animal by puncture of an ear vein or from man by pricking the finger. (Chap. XII.). Centrifuge the blood at once and decant the serum with a Pasteur pipette. The serum is best collected when the individual is fasting (Milhit) : it should be used as soon as possible and always within 2 or 3 hours of collection because the opsonic power rapidly diminishes.

Patient's serum.—This should be collected under the same conditions and at the same time as the normal serum in order that the results may be comparable.

Bacterial emulsion.—[When the rate of growth permits] very young cultures should be used (8–24 hours old according to the organism), and for the same series of experiments cultures of the same age and prepared under identical conditions are necessary.

As a rule, agar cultures are used and one loopful is made into an emulsion with 2 c.c. of normal saline solution. The emulsion must be carefully prepared ; it should be slightly opalescent when held up to the light and must be perfectly homogeneous. If too thick an emulsion be used it will be difficult to enumerate the organisms in the subsequent part of the experiment.

Leucocytes.—1. Cleanse the skin of the thumb, tie an india-rubber ligature around its proximal end and then make several little pricks on the dorsal surface of the distal end near the root of the nail.

2. Allow about thirty drops of blood to flow into a small sterile centrifuge tube containing about 10 c.c. of citrated normal saline solution (fig. 147, p. 192).

3. Mix the blood and citrate solution carefully, centrifuge the mixture for 15 minutes, decant the supernatant liquid with a bulb pipette, add an equal volume of normal saline solution to the deposit, mix and centrifuge again. Then decant the saline solution and wash a second time.

Method of determining the opsonic index.

The following materials and apparatus are necessary :

Apparatus.—Small test-tubes—Pasteur pipettes fitted with india-rubber teats, these should be made from tubing 4–5 mm. in diameter and be drawn out rather long (fig. 162).—Bulb pipettes fitted with a small india-rubber aspirating tube.—A mechanical centrifuge.—An Hearson's opsonic incubator (fig. 161) heated by gas or electricity and regulated at 37° C.

4. After washing three times decant the supernatant liquid being careful not to stir up the deposit of cells. Lay the tube as nearly horizontally as possible and leave it for about half an hour. Then collect the upper whitish layer of cells which is composed almost exclusively of leucocytes. The leucocytes ought to be used within 6 hours of the blood being collected (Milhit).

Experimental details.

1. Take a Pasteur pipette ready furnished with an india-rubber teat, cut off the capillary end squarely with a carborundum pencil and make a small mark on the glass about 2 cm. from the point.



FIG. 162.—Preparation of the mixture for the determination of the opsonic index. The figure shows the three equal volumes of fluid aspirated into the pipette and separated by two bubbles of air.

2. Aspirate into the pipette in turn by lightly relaxing the teat :

(a) A column of leucocytes up to the mark on the glass, then a small bubble of air.

(b) A column of bacterial emulsion up to the same mark, then another bubble of air.

(c) A column of the serum to be examined, again up to the mark.

There are now three equal volumes of fluid in the pipette separated by two small bubbles of air (fig. 162).

3. Expel the liquids on to a sterile slide and mix them together, then draw up the mixture into the pipette again, being careful to avoid taking up any air bubbles. Seal the end in the pilot of a Bunsen, and place the pipette horizontally in the opsonic incubator at 37° C. for 15 minutes.

4. Break off the end of the pipette. Place a drop of the mixture on each of several slides, spread rapidly, dry and fix the films by heat or alcohol-ether. Stain with carbol-thionin or in the case of the tubercle bacillus with carbol-fuchsin.

5. With an oil-immersion lens count the number of the organisms phagocyted by 50 leucocytes.

For example, 120 organisms are counted in 50 leucocytes : the opsonic power of the serum examined is therefore $\frac{120}{50} = 2.40$.

6. Repeat the experiment using normal serum. Suppose 90 organisms are counted in 50 leucocytes : the opsonic power of the normal serum is $\frac{90}{50} = 1.80$.

(For clearness of description the two investigations—the opsonic power of the suspected serum and that of the normal serum—have been described successively. In practice, of course, they will be taken in hand together.)

7. The opsonic index being the ratio of the opsonic power of the suspected serum to that of the normal serum is :

$$\frac{2.40}{1.80} = 1.33.$$

PART II.
THE BACTERIA.

CHAPTER XV.

BACILLUS DIPHThERIE.¹

Introduction.

Section I.—Experimental inoculation, p. 247.

1. Symptoms and lesions produced in animals susceptible to infection, p. 247.
2. Influence of other organisms on the clinical course of the disease, p. 249.

Section II.—Morphology, p. 250.

1. Microscopical appearance and staining reactions, p. 250.
2. Cultural characteristics, p. 253.

Section III.—Biological properties, p. 254.

1. Vitality and virulence, p. 254.
2. Bio-chemical reactions, p. 256.
3. Toxin, p. 257.
4. Vaccination, p. 262.
5. Serum therapeutics, p. 265.
6. Agglutination, p. 269.

Section IV.—Detection, isolation and identification of the diphtheria bacillus—The clinical diagnosis of diphtheria, p. 269.

1. Collection of the material, p. 270.
2. Methods of examination, p. 270.
3. Summary of diagnostic tests, p. 273.

Bacillus pseudo-diphtherie.

(Hofmann's bacillus).

1. Introduction, p. 273.
2. Morphology and staining reactions, p. 273.
3. Cultural characteristics and bio-chemical reactions, p. 274.
4. Virulence and immunity reactions, p. 274.
5. The relation of Hofmann's bacillus to the diphtheria bacillus, p. 274.

The diphtheria bacillus was discovered by Klebs but the first complete description of the organism was contributed by Lœffler, while the specific relationship of the bacillus to the disease was established by Roux and Yersin who experimentally produced symptoms of paralysis in animals.

Distribution of the diphtheria bacillus.

1. In man.

The Klebs-Lœffler bacillus is found in the false membranes of faucial, nasal and cutaneous diphtheria, and in croup. Inflammatory conditions of the throat in which no false membrane is formed are also sometimes due to the diphtheria bacillus, and in these cases the true nature of the disease can only be determined by bacteriological examination.

The bacillus is generally localized in the false membrane or on the infected mucous membrane: it does not as a rule invade the tissues: death is the result of a true

¹ The diphtheria bacillus with the pseudo-diphtheria bacillus, the xerosis bacillus and the bacillus of glanders, are by German writers classified together as the *Corynebacteria*, and known respectively as the *C. diphtherie*, *C. commune*, *C. conjunctive* and *C. mallei*. The group is characterized by the presence of metachromatic granules and club-shaped swellings at the ends of the organisms, and by the appearance of branched forms in old cultures.

intoxication. In a few severe cases of diphtheria however the organism has been found after death in the blood and internal organs (Babès, Spronck, and others): and it is frequently found in the broncho-pneumonic patches which follow an attack of croup (Lœffler, Kutscher).

The bacillus is also found in the mouths and nasal cavities of persons who have suffered from diphtheria, sometimes for many weeks after recovery from the disease. ["In 3 weeks about 30 per cent. of diphtheria patients are free from morphologically typical diphtheria bacilli. In 20 per cent. the bacilli persist for 4 weeks, in 16 per cent. for 5 weeks, and in 11 per cent. for 7 weeks. One per cent. harbour them for 15 weeks and in exceptional cases they remain in the throat for 30 weeks, though even more prolonged periods of persistence are recorded" (Graham-Smith). Fully virulent diphtheria bacilli have been recovered after as long as 335 days (Prip), 230 days (Schäfer), 215 days (Belfanti): these and other observations "conclusively prove that diphtheria bacilli are capable of retaining their virulence during very prolonged persistence in the throats of infected persons" (Graham-Smith).]

[Diphtheria bacilli, a very large proportion of which are virulent, are also present in the throats and noses of "contacts"—persons who have recently been in intimate connexion with the disease. It would even appear that less than half the number of individuals in whom the bacillus obtains a lodgment are attacked by the disease. Graham-Smith gives statistics which show that amongst infected families (relatives and attendants) 36·6 per cent. are liable to become infected, while the mean percentage of infection amongst inmates of hospital wards and institutions is 14 per cent. and amongst scholars of infected schools 8·7 per cent.]

Though the fact is denied by several writers there can be no doubt but that the diphtheria bacillus may occasionally be found in the mouths of persons who have not been in contact with diphtheria: [but an investigation in England showed that of 2132 persons who had not so far as could be determined been exposed to infection 0·18 per cent. were found to be harbouring a virulent diphtheria bacillus and 2·62 per cent. non-virulent bacilli, and in the absence of further evidence these figures undoubtedly point to the conclusion "that virulent diphtheria bacilli are seldom if ever present in the throats of healthy persons who have not recently been in contact with cases of diphtheria or infected contacts" (Graham-Smith).]

2. In the lower animals.

[Cows.—According to Klein cows can be experimentally infected with diphtheria, and lesions containing diphtheria bacilli may appear on the teats and udders as a result of the infection: diphtheria bacilli may also be present in the milk after experimental inoculation. From these observations Klein inferred that cows might naturally suffer from diphtheria and that the milk of such cows might be a cause of human infection.

[Klein's experimental results have not been confirmed and most observers hold that there is no evidence that diphtheria is a bovine disease (Graham-Smith). On two occasions however virulent diphtheria bacilli have been recovered from spontaneous lesions of the udder and teats of cows. In one of these cases investigated by Dean and Todd these observers came to the conclusion that though diphtheria bacilli were present, the lesions in the cow were not due to that organism. In the other case Dean and M'Conkey independently isolated the diphtheria bacillus from the lesions in the cow but neither the source of the bacillus nor its relation to the ulcers was determined.

[Horses.—The diphtheria bacillus has only once been isolated from the horse. It was then found by Cobbett in a purulent and slightly sanguineous discharge from the nose of a pony.

[Cats and fowls and other animals.—"Both cats and fowls have frequently been regarded as carriers of the disease, but the bacteriological evidence in support of these statements is unsatisfactory. Instances of natural infection amongst other animals are unknown, though bacilli closely resembling diphtheria bacilli in many of their characters have been found in dogs, guinea-pigs, rats, fowls, turkeys and pigeons" (Graham-Smith).

[These observations on the occurrence of diphtheria in the lower animals may be

¹ *The Bacteriology of Diphtheria*, edited by G. H. F. Nuttall and G. S. Graham-Smith; Camb. Univ. Press.

summarized by saying that only once has a true diphtheria bacillus been isolated from an animal spontaneously infected. The disease must therefore be exceedingly uncommon among the lower animals, and statements to the effect that a case has been observed, or an outbreak of diphtheria traced to infection from the lower animals, should not be accepted without rigorous investigation.]

3. In the circumambient media.

The diphtheria bacillus is able to live outside the human body. Park, Wright and Emerson found the organism in the dust of diphtheria wards and on the clothes of the attendants. Abel also found it on the toys with which children infected with diphtheria had been playing.

Bacillus pseudo-diphtheriæ.

The pseudo-diphtheria or Hofmann's bacillus, an organism in some respects closely resembling the diphtheria bacillus but differing from it in being shorter and non-pathogenic to laboratory animals and in other particulars, is fairly frequently met with in the mouths of healthy persons.

Reference is again made to this organism later in the present chapter (p. 273).

SECTION I.—EXPERIMENTAL INOCULATION.

1. Symptoms and lesions produced in animals susceptible to infection.

(a) Guinea-pigs.

The guinea-pig is the most suitable animal for the study of experimental diphtheria. The organism may be introduced either under the skin, into the peritoneal cavity, into the trachea or on to mucous surfaces.

1. **Sub-cutaneous inoculation.**—0·5 c.c. of a twenty-four-hour broth culture inoculated sub-cutaneously will kill the animal in 24–72 hours according to the virulence of the organism. Following the inoculation there is a slight œdema at the site of inoculation and a rise of temperature; the animal shows symptoms of illness and finally dies.

If only a slightly virulent culture be used, the animal may recover; in that case there is some œdema at the site of inoculation, followed by a slough which heals in course of time. [Similar effects result from the inoculation of sub-lethal doses of fully virulent cultures.] In the œdema at the site of inoculation the bacilli multiply for the first 6 or 8 hours following the inoculation, after which multiplication ceases and their numbers decrease so that *post mortem* relatively few organisms are found in the clear œdematous fluid.

The organisms do not pass into the blood and internal organs. *Post mortem* there is a very marked congestion of the internal organs and especially of the supra-renal capsules, and a large pleural effusion. The fluid is occasionally blood-stained: it contains no bacilli.

2. **Intra-peritoneal inoculation.**—The symptoms following intra-peritoneal inoculation are less severe than after sub-cutaneous inoculation: death is longer delayed and does not occur till between the fourth and the twelfth day. Over and above the ordinary visceral lesions there is an effusion of fluid into the peritoneal cavity and it is only in this situation that bacilli can be found.

3. **Intra-tracheal inoculation.**—Tracheotomy is first performed; the tracheal mucous membrane is then abraded and a portion of a culture of diphtheria bacilli applied. A false membrane forms on the abraded surface which sets up a true condition of croup rapidly followed by death. An essential condition of success is that the mucous membrane be traumatized; the bacilli fail to develop on the uninjured membrane.

4. Infection of mucous membranes.—False membranes may be produced by applying traces of culture to the scarified surfaces of the conjunctiva or vulva of the guinea-pig.

(b) **Rabbits.**

The rabbit is far less susceptible to the diphtheria bacillus than the guinea-pig and only succumbs to the inoculation of very virulent cultures.

1. Sub-cutaneous inoculation.—The inoculation of 2 c.c. of a very virulent broth culture leads to the death of the animal in about 5 days. There is an œdema at the site of inoculation: the internal organs are congested and dotted with hæmorrhagic points: the inguinal and axillary glands are swollen, the liver jaundiced and friable and shows fatty degeneration: as a rule the lungs are normal: rarely there is some effusion into the pleural cavities. A sub-lethal dose leads to paralysis, affecting chiefly the hind-quarters.

2. Intra-peritoneal inoculation.—The results of intra-peritoneal inoculation are less severe, and death only takes place after some lapse of time. The lesions are similar to those mentioned above.

3. Intra-venous inoculation.—Following the inoculation of 1–2 c.c. of a virulent culture into an ear vein death takes place in from 30–60 hours. At the *post-mortem* examination an acute nephritis in addition to the ordinary lesions is found: the organisms do not multiply in the blood stream being rapidly taken up by the phagocytes (Métin).

4. Inoculation on a cutaneous surface.—Roux and Yersin obtained excellent examples of false membranes by blistering a small area on the internal surface of the ear and then applying a trace of a culture of the diphtheria bacillus to the exposed dermis. It is essential that the infected surface should not be allowed to dry; the ear may be enclosed in a small rubber bag, care being taken that the vessels are not compressed at the base. To stop the development of the membrane it is only necessary to uncover the ear.

5. Intra-tracheal inoculation.—A typical condition of croup is produced as in the guinea-pig but more easily.

6. Inoculation on mucous surfaces.—The results are the same as in the guinea-pig.

(c) **Dogs.**

The dog is susceptible to infection with the diphtheria bacillus.

1. Sub-cutaneous inoculation.—Death ensues in 3 or 4 days. Roux and Yersin noted œdema at the site of inoculation, jaundice and finally a progressive paralysis: the fluid of the œdema contained bacilli but the blood was sterile.

2. Intra-tracheal inoculation.—Roux and Yersin produced a swelling of the neck, jaundice, complete paralysis, and death on the fourth day. *Post mortem* no false membrane was found in the trachea.

(d) **Cats.**

Death follows sub-cutaneous inoculation in 6–13 days. A cat fed on milk from a cow [said to be] suffering from diphtheria with ulcers on the udder also contracted the disease (Klein).

(e) **Cows.**

Klein [claims to have] shown that the cow can contract diphtheria both by spontaneous infection and as a result of experimental inoculation (*vide ante*).

Cows inoculated with a young and virulent culture of the diphtheria bacillus died with congestion of the internal organs; but using agar cultures several days old, Klein was unable to set up a fatal disease. This observer on several occasions noted an eruption on the udder [of cows which had not been experimentally infected]

which commenced as a papule, became a vesicle, then a true pustule and finally an ulcer: the diphtheria bacillus was found in the vesicles and was traced on many occasions into the milk. Klein observed a similar eruption on two cows which succumbed to the inoculation of a very virulent culture. [Other observers have failed to confirm these experiments.]

(f) **Birds.**

Pigeons and fowls rapidly succumb to the inoculation of a broth culture of the diphtheria bacillus injected sub-cutaneously or into the pectoral muscles in doses of 1 c.c.: death takes place in less than 60 hours. With doses of less than 0·2 c.c. the animal usually recovers; sometimes paralysis is observed. *Post mortem* a thin greyish film and a gelatinous œdema is found around the site of inoculation. When the culture has been inoculated into the muscle the latter is swollen and its fibres have an ochre tint: the internal organs are intensely congested.

Following inoculation of the bacillus into the larynx these animals suffer from croup as do rabbits.

Small birds (sparrows, chaffinches, etc.) are highly susceptible and rapidly succumb to sub-cutaneous inoculation.

(g) **Rats and mice** are immune to diphtheria.

To sum up, it is characteristic of the diphtheria bacillus that it cannot penetrate the tissues of susceptible animals; it remains localized at the site of inoculation and even in this situation its development is quickly arrested, so that passage through a series of animals rapidly becomes impossible.

2. Influence of other organisms on the clinical course of the disease.

Roux and Yersin have shown that certain other organisms may be associated with the diphtheria bacillus and at times play an important part in the clinical manifestations of the disease. The diphtheria bacillus is rarely found in pure culture in the false membranes: occasionally the organisms associated with it are few in number and of no clinical importance, but it often happens that a considerable number of other bacteria are present many of which play an important rôle in the clinical course of the disease and to some extent determine its severity.

Martin has pointed out that the mere presence of a few other organisms with the diphtheria bacillus in cultures sown with the material from a case of diphtheria is not sufficient evidence upon which to base a diagnosis of secondary infection; such an infection can only be diagnosed when the number of other organisms is very considerable. And it is in this connexion that a preliminary microscopical examination of the material from the throat is of great importance, because it can then be determined whether any associated bacillus has multiplied therein and whether it is or is not the predominant organism present: whereas when the material is sown on culture media one species of organism (perhaps sparsely represented originally) may outgrow all others, and moreover the presence of anaërobic organisms may pass entirely unnoticed. It must be remembered that the surface of the membrane may be contaminated by the different organisms of the mouth, and must therefore be cleansed before material is removed for investigation.

The following are the most important of the organisms which may be found in association with the diphtheria bacillus:—

(i) **Brisou's coccus.**—Roux and Yersin and also Martin drew attention to a small coccus which they frequently found associated with the diphtheria bacillus; they called it the *Brisou coccus* after the name of the child from whom they first isolated it. The organism occurs either in the form of single cocci or as diplococci or in clusters. It is gram-positive. On coagulated

serum the colonies are small, whitish in colour and almost transparent, slightly raised and circular. It is not pathogenic to laboratory animals. Usually, though not always, the association of this organism with the diphtheria bacillus is unimportant from the point of view of prognosis.

(ii) *Staphylococcus pyogenes*.—Staphylococci constitute a more serious complication than the preceding: respiratory complications are frequent. In a case in which the *staphylococcus aureus* was associated with the diphtheria bacillus the author observed a considerable swelling of the neck during convalescence.

(iii) *Streptococci*.—According to Martin a secondary infection with streptococci produces the most severe form of diphtheria; broncho-pneumonia frequently supervenes in cases where streptococci are found with the diphtheria bacillus.

Métin demonstrated by experiment upon guinea-pigs the unfavourable influence of staphylococci and streptococci upon the course of the infection: he found that the diphtheria bacillus in such cases multiplied in the blood stream and in the internal organs and was present in enormous numbers at the site of inoculation.

(iv) *Bacillus coli*.—The colon bacillus is not infrequently found in the mouths of healthy persons, and it is therefore to be expected that it should be found in the false membranes in some cases of diphtheria. The multiplication of this organism is a serious complication; three cases recorded by Blasi and Russo-Travalli terminated fatally. These observers grew the diphtheria bacillus and the colon bacillus together and showed that the toxicity of diphtheria cultures was increased considerably.

(v) *Other organisms*.—Association with the *pneumococcus*, with the *pneumobacillus* of Friedländer, with the *proteus vulgaris*, Vincent's *bacillus fusiformis* and the anaërobic organisms of the mouth (Chap. XXXIX.) has also been recorded.

SECTION II.—MORPHOLOGY.

1. Microscopical appearance.

The diphtheria bacillus is a highly pleomorphic organism; it is non-motile, and does not form spores. [In general terms it may be described as a small, slender, straight or slightly curved, usually irregularly-staining rod with rounded and sometimes swollen ends: curved bacilli with swollen ends, resembling a gherkin in appearance, are very characteristic. In size it is subject to considerable variation.]

Various attempts have been made to classify the different varieties of diphtheria bacilli. Three varieties may be distinguished depending upon the length of the organism, viz.

(a) *Short bacilli* almost like cocci. They measure about $2\mu \times 0.8\mu$ and often occur in pairs arranged parallel to one another (p. 254).

(b) *Bacilli of intermediate size*, measuring $3-4\mu \times 0.8\mu$. These bacilli are arranged parallel to one another or are found in pairs end to end, the latter often forming an acute angle like the letter V or a circumflex accent.

(c) *Long bacilli* $4-5\mu$ or more in length. In culture they are seen to be interlaced and without definite arrangement, very like brushwood. These bacilli generate the most potent samples of toxin (p. 257) and are usually found in severe cases of diphtheria. On the other hand, the short bacilli (group a) are as a rule almost avirulent (Martin).

[Another basis of classification of diphtheria bacilli is that worked out by Cobbett. This observer relied on the staining reactions alone and was thus able to distinguish five groups of diphtheria bacilli in young serum cultures.

(Size and form were as will be seen found to be in close relation to similarity in staining reaction.)

(a) Irregularly beaded bacilli—long and faintly stained—the type most frequently seen.

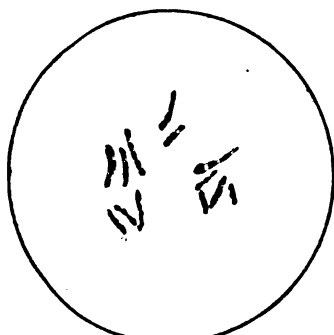

FIG. 163.

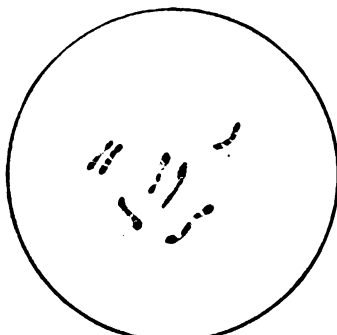

FIG. 164.

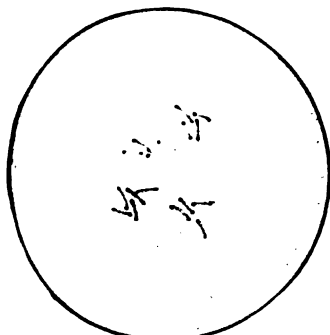

FIG. 165.

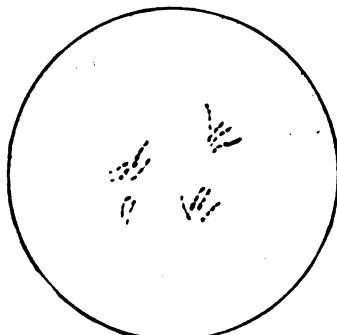

FIG. 166.

FIGS. 163, 164, 165, and 166.—Types of diphtheria bacilli from young serum cultures. Mounted in dilute Loeffler's blue (1 in 5 with water). Oc. 4; obj. 43th, Zeiss.

(β) Regularly beaded bacilli—streptococcal forms—stain darkly and may be mistaken for streptococci.

(γ) Barred, segmented or banded forms.

(δ) Uniformly stained bacilli.

(ε) Oval bacilli with one unstained septum.

[This last type is found in greatest numbers in very young cultures: they are probably young forms, and it is to be noted that individuals of this type are—morphologically—practically indistinguishable from typical forms of Hofmann's bacillus.]

Branched forms of the diphtheria bacillus have been described by Babès, Escherich, Concetti and others.

Involution forms in which one or both ends are swollen giving the organism a pear-shaped, clubbed, or dumb-bell-like appearance are sometimes met with in old cultures and in smears made from the false membrane.

Staining methods.

(a) The diphtheria bacillus stains readily with the basic aniline dyes. Films from cultures or membranes may be stained with diluted Loeffler's

alkaline methylene blue [1 to 4 of water], Roux's blue or with dilute Ziehl's fuchsin. [The first of these is the stain strongly recommended.]

[The method recommended is that devised by Cobbett. Spread films, dry and fix in the ordinary manner. Wash in 10 per cent. acetic acid. Wash in water. Mount in a drop of Loeffler's blue diluted 5 times with water. Blot. Examine.]

When stained with methylene blue [and especially with a dilute blue] the bacilli are found to be irregularly stained, granules being seen which stain more deeply than the protoplasm: these granules or metachromatic bodies of Babès are sometimes called polar bodies. German writers, in the determination of the diphtheria bacillus, attach great importance to their presence. [But though the majority of diphtheria bacilli show these Babès' bodies, some types stain uniformly; moreover some bacilli other than diphtheria bacilli also show deeply-staining granules.] The diphtheria bacillus, especially in old cultures, frequently shows irregular vacuolated spaces which do not stain, whatever dye be used; it is to be noted that these are not spores.

(b) **Gram's method.**—The diphtheria bacillus is gram-positive. Decolourization must not be pushed too far because the organism will not resist a prolonged action of alcohol. Gram's method gives beautiful preparations with smears and sections of false membranes.

(c) **Special methods.** (a) **Neisser's stain.**—To bring out the polar bodies the method of Ernst-Neisser may be applied.

Two solutions are necessary—

| | | | | | | | | |
|------------------------------|---|---|---|---|---|---|---|---------|
| A. Methylene blue (Grübler), | - | - | - | - | - | - | - | 1 gram. |
| 96 per cent. Alcohol, | - | - | - | - | - | - | - | 20 c.c. |
| Distilled water, | - | - | - | - | - | - | - | 950 " |
| Glacial acetic acid, | - | - | - | - | - | - | - | 50 " |

Dissolve the blue in the alcohol, then add the water and acid.

| | | | | | | | | |
|--------------------------|---|---|---|---|---|---|---|-----------|
| B. Vesuvin, | - | - | - | - | - | - | - | 0.5 gram. |
| Boiling distilled water, | - | - | - | - | - | - | - | 250 c.c. |

A cover-glass preparation is made with a drop of an emulsion of an eighteen-hour-old culture on serum.

This is left in the acid solution of blue for 1-3 hours, washed in water, stained for a few seconds in the vesuvin solution, washed again and mounted. [The method may be modified by staining for 1 minute in each of the blue and brown solutions, washing in water between the two operations.]

So stained the diphtheria bacillus is brown, with deep blue [or violet] granules situated as a rule at the poles or ends. (The pseudo-diphtheria [Hofmann] bacillus, on the other hand, according to Neisser, never shows polar bodies, but is stained uniformly brown or has some blue grains irregularly distributed through the body of the organism. It is now admitted that this reaction is not characteristic.)

[(β) The following is a modification of Neisser's stain which apparently gives better results than that just described.

Prepare two solutions:

| | | | | | | | | |
|------------------------------|---|---|---|---|---|---|---|---------|
| A. Methylene blue (Grübler), | - | - | - | - | - | - | - | 1 gram. |
| Absolute alcohol, | - | - | - | - | - | - | - | 50 c.c. |
| Glacial acetic acid, | - | - | - | - | - | - | - | 50 " |
| Distilled water, | - | - | - | - | - | - | - | 1000 " |



FIG. 167. — Diphtheria bacilli stained by Neisser's method. Oc. 4 Obj. $\frac{1}{2}$ th Zeiss.

| | | | | | | | | |
|-----------------------------|---|---|---|---|---|---|---|---------|
| B. Crystal violet (Höchst), | - | - | - | - | - | - | - | 1 gram. |
| Absolute alcohol, | - | - | - | - | - | - | - | 10 c.c. |
| Distilled water, | - | - | - | - | - | - | - | 300 " |

1. Stain for 1 second or longer in a mixture made just before use of 2 parts of **A** and 1 part of **B**.

2. Wash rapidly in water.

3. Counterstain for 3 seconds in cresoidin solution.

| | | | | | | | | |
|-------------|---|---|---|---|---|---|---|------------|
| Cresoidin, | - | - | - | - | - | - | - | 1 part. |
| Warm water, | - | - | - | - | - | - | - | 300 parts. |

When dissolved, filter.

4. Wash in water.]

(γ) For staining the polar bodies Epstein recommends pyronin. Stain for 20 seconds in pyronin, wash, treat with Gram's solution for 10 minutes, dry and mount. The polar bodies are stained bright red, the bacilli pale red.

Note.—The diphtheria bacillus becomes decolorized very quickly when mounted in balsam. For permanent preparations the following method is recommended.

1. Stain in dilute Ziehl's fuchsin for 1-3 minutes. Wash in water.

2. Stain in the same manner with Roux's blue. Wash, dry, and mount.

2. Cultural characteristics.

A. Conditions of growth.—The diphtheria bacillus will grow at all temperatures between 20° C. and 40° C. but not above 42° C., the optimum being 35°-37° C. The bacillus is aerobic: some growth however takes place under anaerobic conditions, but it is poor and the organism rapidly loses its vitality.

B. Media. 1. **Broth.**—Peptonized-veal-broth gives a better growth than beef-broth.

After incubating at 37° C. for 12-24 hours small white masses of growth will be seen adhering to the sides of the flask and later a film forms on the surface: if examined microscopically this film will be found to consist of tangled masses of bacilli many of the latter being club-shaped. Finally, a deposit forms at the bottom of the tube leaving the supernatant fluid clear. The best way to obtain rapidly a luxuriant growth is to sow the bacillus in a flat flask and pass a current of air over the growth during incubation.

For this purpose select a flask similar to that (Fernbach's) shown in fig. 168. Fill it with broth through the central vertical tubulure until the level of the fluid reaches to just below the openings of the lateral tubulures: plug all three openings with wool, sterilize in the autoclave, sow through the vertical tubulure, replace the wool plug and cover it with an india-rubber cap. Now attach one of the lateral tubes to a water pump and draw a slow current of air through the flask; the air entering by the other tube sweeps in a continuous stream over the surface of the broth.

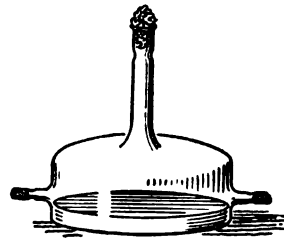

FIG. 168.—Fernbach's flask.

When the diphtheria bacillus is grown in broth the reaction of the latter first becomes acid, but after a few days this initial acidity is converted into an alkaline reaction accompanied by a precipitate of ammonio-magnesium phosphate. In media containing glycerin the acid reaction is very marked and persistent, and the bacilli rapidly die in such media.

Martin's broth (p. 33) is better than ordinary broth and in it growth is very luxuriant, the medium never becomes acid and the virulence of the bacilli is maintained for a long time.

2. **Coagulated serum.**—On coagulated serum which is the best medium for the diphtheria bacillus growth is very rapid.

(a) **Isolated colonies** (grown on the surface).—After 18 hours (at 37° C.) greyish white points are seen which rapidly grow to the size of a pin's head: by transmitted light the colonies are more opaque in their centres than at their margins: as growth proceeds they attain a diameter of 5 mm., remain regular and are sometimes pale yellow in colour.

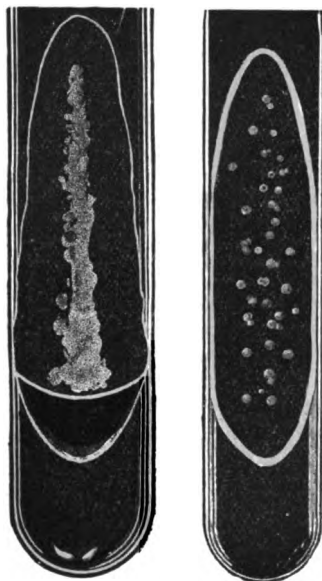

FIG. 169.—Cultures of the diphtheria bacillus.

1. Surface culture on agar (3 days at 37° C.). 2. Isolated colonies on serum (24 hours).

(β) **Stroke cultures**.—Colonies similar to those described above appear along the line of sowing; these soon become confluent and form a fairly broad greyish band with irregularly serrated margins.

The long, short and medium sized varieties of the diphtheria bacillus cannot be distinguished by the characters of the growth on serum; colonies of the short variety are, however, sometimes whiter and moister than usual; these whiter colonies will be found to grow at room temperature, and are in fact colonies of the pseudo-diphtheria or Hofmann's bacillus (*vide infra*).

3. Agar.—Colonies on agar are very similar to those on serum though sometimes larger and whiter. Growth is somewhat slower.

4. Gelatin.—Stab cultures in gelatin (15 per cent.) at 22°–24° C. give rise to a very poor growth consisting of small white punctiform colonies along the line of the stab. The diphtheria bacillus does not liquefy gelatin.

5. Potato.—The diphtheria bacillus does not appear to grow on potato; some observers have however described a delicate growth consisting of an almost invisible yellowish glaze.

6. Egg albumin.—Sakaroff recommends white of egg coagulated by heat as a medium in place of blood-serum (p. 53, B). When sown on the surface of this medium, and incubated for 24 hours, the diphtheria bacillus grows in the form of small, dull, slightly transparent, hemispherical colonies somewhat darker in colour than the medium: sometimes towards the twelfth day the growth may be of a brown or flesh colour.

7. Milk.—The diphtheria bacillus grows luxuriantly in fresh milk. The medium is not coagulated.

SECTION III.—BIOLOGICAL PROPERTIES.

1. Vitality and virulence.

Vitality.

The diphtheria bacillus remains alive in culture for a considerable length of time: sub-cultures can be grown from a culture 5 or 6 months old.

In moist cultures the bacillus is readily destroyed: exposure to a temperature of 58° C. for a few minutes is sufficient to sterilize a broth culture.

When dried, the bacilli are more resistant to the action of heat and can be subjected to a temperature of 95° C. for several minutes without being killed.

The diphtheria bacillus shows even greater powers of resistance to heat

in the false membranes : thus a false membrane may be dried and exposed to a temperature of 95°–100° C. for an hour, and yet the bacilli may be found to have escaped destruction when cultures are sown.

Drying has but little effect on the vitality of the diphtheria bacillus if albuminous matter be present : thus Roux and Yersin dried a piece of membrane and kept it away from the light at room temperature ; portions of it sown 3 months or 5 months later yielded cultures of the diphtheria bacillus. Bacilli from serum cultures are more easily destroyed by drying especially if they be rapidly dried. Light has considerable bactericidal properties : thus if a piece of false membrane be dried and then exposed to air and sunlight the organisms are destroyed in a relatively short space of time. Roux and Yersin, for instance, found no living bacilli in a piece of membrane which had been dried and then exposed to air and sunlight for a period of 6 weeks. A culture on serum which had been dried and spread in a thin layer was found to be sterile after an exposure of 24 hours to diffused light (Ledoux-Lebard).

Antiseptics rapidly sterilize cultures of the diphtheria bacillus : 1 per cent. carbolic acid, 2 per cent. bichromate of potassium etc. kill cultures instantly.

If silk threads be dipped in a culture of the diphtheria bacillus and dried, it will be found that the organisms on the dried threads are more resistant to the action of antiseptics and can withstand the action of 1 per cent. carbolic acid, 5 per cent. salicylic acid in alcohol, etc. for several minutes (Chantemesse and Vidal). The resistance of the bacilli in false membranes to antiseptics is even greater.

Virulence.

The virulence of a given diphtheria bacillus must be tested as follows :

Sow the organism in broth, incubate at 37° C. for 24 hours, inoculate 1 c.c. beneath the skin of a guinea-pig weighing 400–500 grams. One of several results may follow :

- (α) In the case of a very virulent bacillus death will occur in 24–30 hours.
- (β) In the case of a bacillus of intermediate virulence the animal will succumb in 2–6 days.
- (γ) In the case of a slightly virulent organism death may not take place for 8–10 days.
- (δ) In the case of a bacillus of very low virulence the animal will survive but a local œdema followed by a slough will form at the site of inoculation.
- (ε) Finally, should the bacillus be avirulent no lesion whatever will follow the inoculation.

[It will be necessary, as pointed out above, to make certain that the bacillus used for inoculation is growing well in broth.]

The virulence of the organisms isolated from false membranes is very inconstant : in severe cases, virulent bacilli are very numerous : in mild cases in addition to colonies of virulent bacilli, numerous colonies of non-virulent organisms will be found.¹

[The *pathogenicity* of different strains of the diphtheria bacillus when first isolated, as tested with two-day broth cultures, varies greatly (minimal lethal dose varies as 400 to 1) ; and the *virulence* of washed bacilli from two-day broth cultures of different strains varies at least as much as the *pathogenicity* of whole cultures. (Arkwright).]

(a) **Attenuation of virulence.**—In old cultures the diphtheria bacillus loses much of its virulence but the latter can be fully recovered by sowing the

[¹ It is not justifiable to assume that because a diphtheria bacillus is non-pathogenic to laboratory animals that it is therefore non-pathogenic to man : on the other hand there is some evidence to show that “non-virulent” diphtheria bacilli are capable of producing diphtheria in a susceptible human subject.]

organism in broth. On the other hand, when the organism is grown at 39° C. on glycerin-agar or on broth with a current of air passing over it, it loses its virulence rapidly, so that on inoculation into a guinea-pig nothing more than a local œdema results (Roux and Yersin).

The same fact may be observed by drying a false membrane from a case of diphtheria and exposing it to the air: the organism remains alive for a long time, but if fragments of the membrane be sown from day to day it will be found that the number of non-virulent colonies increases. The bacilli thus artificially attenuated have all the characteristics of the pseudo-diphtheria—Hofmann's—bacillus (see p. 273). [It would seem that the explanation of this result is to be found in the supposition that both the diphtheria bacillus and Hofmann's bacillus were present in the original membrane and that the former died out. All attempts to convert a diphtheria bacillus into an Hofmann and *vice versa* have invariably failed (p. 274).]

(b) **Restoration of virulence.**—It is impossible to restore the virulence of an organism which has become so attenuated as to have entirely lost its virulence for the guinea-pig (Roux and Yersin).

On the other hand, Roux and Yersin succeeded in restoring the virulence of an organism which produced nothing more than a slight œdema in the guinea-pig; they inoculated the bacillus, and with it a virulent culture of a streptococcus, into a guinea-pig: the animal succumbed with symptoms of diphtheria and the bacillus recovered from the fluid of the local œdema was found to have very distinctly increased in virulence. According to Blasi and Russo-Travalli association with the colon bacillus has a similar effect in restoring the virulence of the diphtheria bacillus. Trumpp, by inoculating a mixture of small doses of diphtheria toxin and an almost non-virulent bacillus, was also able to restore the virulence of the organism.

(c) **Exaltation of virulence.**—Roux and Yersin failed to raise the virulence of the diphtheria bacillus by passage through guinea-pigs or rabbits. Bardach after passing the bacillus through twenty-five dogs noted a distinct increase in virulence for the dog but only a slight increase in virulence for the guinea-pig.

Martin grew the bacillus in collodion sacs in the peritoneal cavities of a series of rabbits and succeeded in raising the virulence for that animal, but found that the virulence for the guinea-pig was unaltered.

[Thus the virulence of the diphtheria bacillus, while easily lowered, is difficult to increase by laboratory methods.]

[2. Bio-chemical reactions.]

[(a) **Action on carbohydrates.**—“All strains of the diphtheria bacillus produce acid from glucose, galactose, lævulose, and maltose. Most form acid out of dextrine and glycerine. On lactose the action is very variable, and only a few strains act on saccharose. All tests on mannite yielded negative results” (Graham-Smith). No gas is formed in any of the media.

[In testing the action of diphtheria bacilli upon carbohydrates the most suitable medium to which to add the carbohydrate is Hiss's serum-water medium (Chap. XL). To this solution, 1 per cent. of the carbohydrate is added.

[If sugar-free broth be used the results may not be so uniform, because as has already been pointed out some strains of the diphtheria bacillus do not grow readily on such broth when first isolated from the body.

[(b) **Indol.**—The diphtheria bacillus does not appear to form indol (Theobald Smith and others), but some observers are said to have obtained an indol reaction after prolonged cultivation.]

3. Toxin.

Diphtheria, as Roux and Yersin showed, is an intoxication with the highly poisonous products of the diphtheria bacillus. These products, as the same observers proved, are also present in broth cultures of the bacillus.

In their first experiments Roux and Yersin were only able to manufacture a very weak toxin of which 30 c.c. were required to kill a guinea-pig. Martin now prepares a toxin which is fatal to adult guinea-pigs in doses of $\frac{1}{30}$ c.c. and even $\frac{1}{300}$ c.c. [Toxins even more powerful than this have been prepared.]

(a) Preparation of diphtheria toxin.

Conditions under which toxin is elaborated.—Diphtheria toxin is obtained by growing a toxigenic¹ bacillus in presence of air.

A. Selection of the organism.—The strain to be used for the preparation of toxin should first of all be tested on animals. To be suitable for the purpose, 1 c.c. of a broth culture of the organism should when inoculated beneath the skin of a guinea-pig weighing 300–400 grams prove fatal in 24–36 hours. But as it has been found that bacilli isolated from very severe cases of diphtheria are not always powerfully toxigenic [and on the other hand some bacilli are toxigenic and non-virulent] the toxigenic capacity of the organism should always be tested before embarking upon the manufacture of large quantities of toxin. [At the present time a bacillus known as Park and Williams' bacillus No. 8 is extensively used for the preparation of toxin. Park and Williams recovered this organism from a mild tonsillar case of diphtheria.]

To preserve the toxigenic properties of a diphtheria bacillus sow it on Martin's broth, and after incubating for a week at 33°–35° C. remove the tubes from the incubator and keep them in the dark. Martin keeps 48-hour cultures on coagulated serum at 10°–12° C. Old cultures stored in this way on being revived by a couple of sub-cultivations yield a bacillus which has a very considerable power of toxin production.

B. The choice of medium.—The amount of toxin produced depends upon the composition and especially upon the reaction of the medium.

It has already been pointed out that when the diphtheria bacillus is cultivated upon an alkaline broth the medium is first turned acid but after a few days again becomes alkaline; and it is just when the acid reaction begins to diminish that the toxin begins to be formed, after that the toxicity of the broth increases *pari passu* with the alkalinity of the medium, and the more rapidly the alkalinity increases the more rapidly does the amount of toxin increase. If the formation of acid be prevented toxin will be formed both more rapidly and also in larger quantity. As the result of experiment many methods have been devised for diminishing or altogether preventing the initial formation of acid. Roux, Yersin and Martin shortened the period of acid reaction by growing in a current of air, and this method has been used for a long time in the preparation of toxin on a large scale. Many observers have aimed at excluding from the culture medium all those substances (*e.g.* glucose, lævulose, saccharose, galactose, glycerin) from which the diphtheria bacillus forms acid. Nicolle, for instance, obtained a satisfactory toxin by using fresh meat—meat, that is, in which the glycogen had not had time to be converted into glucose (glycogen not being convertible into acid); Spronck on the contrary suggested the use of meat which was

¹The disease-producing power of a diphtheria bacillus may be regarded as made up of two elements, toxicity and virulence. The former represents the rate of accumulation by it of toxin in culture fluids, the latter the behaviour of the bacillus towards living tissue (Theobald Smith).]

rotten and from which the sugars had vanished. Park and Williams in their investigations used a broth previously made alkaline with soda: Macé employed a broth to which calcium carbonate had been added. None of these methods however give results as good as those obtainable by the method devised by Martin. This observer succeeded in finding a medium in which no acid reaction is developed and which yields highly toxic cultures.

1. Method of Roux and Martin.—The bacillus is grown in a current of air, and for this purpose a flask (modified from Fernbach's) similar to that shown in the illustration (fig. 170) is very convenient.

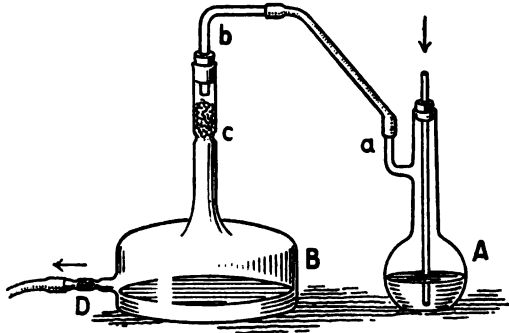

FIG. 170.—Flask arranged for the growth of the diphtheria bacillus for toxin production (Roux and Martin's method).

Pour into each flask 400–500 c.c. of veal broth; this quantity should not form a layer more than 2 or 3 cm. deep, and the surface of the broth should be below the opening of the lateral tube D. Plug the lateral tube D and the neck of the flask C with cotton-wool: autoclave the flask and its contents: allow to cool and sow the medium through the neck C. Incubate at 37° C. and after about 24 hours or so—when the growth is well started and the broth has become cloudy—arrange the flask so that a current of air can be passed over the surface of the broth, thus:—Into the neck of the flask B and above the wool plug fit an india-rubber plug through which a piece of glass tubing, *b*, bent at right angles is passed, and connect this with a second flask A containing a little water through which the air is made to bubble. Attach the tube D by means of a piece of india-rubber tubing to a water pump. When the water is turned on air is bubbled through the water in A—where it is saturated with moisture—and drawn over the surface of the culture in B which is thus aerated. By means of a clip on the tube connecting the flasks A and B the amount of air can easily be regulated so that a constant but not violent stream of air can be drawn through the flask.

After incubating for 3 or 4 weeks the culture is sufficiently rich in toxin. At the bottom of the flask there is a deposit of micro-organisms and on the surface a thin layer of young bacilli. The reaction is strongly alkaline.

The culture is now filtered through a Chamberland bougie by one of the methods already described (Chap. I.). The filtrate kills adult guinea-pigs in doses of 0.1 c.c.

2. Martin's method. Method recommended.—The need for the current of air is obviated, and hence also the necessity for complicated apparatus: it is quicker than the method just described and yields moreover a more powerful toxin. A dose of $\frac{1}{200}$ th c.c. of this toxin is sufficient to kill a guinea-pig.

Martin uses a peptonized veal broth (p. 33) sterilized by filtration¹ and

¹ If sterilized at 120° C. this medium does not give such good results. It is better to filter or, failing filtration, to sterilize on three successive days at 100° C.

distributed in thin layers (3-4 cm. deep) in large flasks. The organism soon becomes accustomed to the medium, and grows well in it.

Character of growth.—A film forms on the surface during the first 24 hours and increases both in area and in thickness during the next 24 hours (reject all organisms which do not form a film about the end of the third day). If the culture is growing well the film breaks up and falls to the bottom; a new film then forms and this in turn sinks to the bottom about the sixth day, after which no further film is formed. The medium is never acid to litmus, but on the other hand about the second to the fourth day it is alkaline to phenol-phthalein.

The culture should be filtered about the end of the first week when its toxicity is at its maximum; after about a fortnight the toxin content begins to diminish.

3. [G. Dean's method. Recommended.]—This is a less complicated method than Martin's and is somewhat similar to that described by Park and Williams.

[The broth is prepared with "silverside" of beef and the meat may be used either perfectly fresh or after hanging for 7-12 days at a temperature of 8° C. Free the beef from all fat and fascia and then mince very finely. To each pound (about 500 grams) of beef add 1 litre of fairly alkaline tap water. Put the meat and water into an enamelled saucepan, cover with the lid, and allow to boil quietly for 1-2 hours. Filter through Swedish filter paper, thoroughly squeezing out all the juice from the beef. To the filtrate add 2 per cent. Witte's peptone and 0.5 per cent. sodium chloride. Steam at 100° C. for 1 hour. Filter. Make the filtrate neutral to litmus and then add 7 c.c. of normal soda per litre while still hot. Steam again for 1 hour. Filter. Distribute in Erlenmeyer flasks. Steam at 100° C. for 20 minutes and then allow the temperature to run up to 120° C. before turning out the gas.

[The toxicity in the case of 39 toxins prepared by Dean with this medium and the American bacillus (p. 257) is shown in the following table.

| | | |
|---|---------------------------|----------------------|
| | 1 killed within 6 days at | $\frac{1}{700}$ c.c. |
| 1 | " " | " $\frac{1}{800}$ " |
| 8 | " " | " $\frac{1}{300}$ " |
| 9 | " " | " $\frac{1}{400}$ " |
| 7 | " " | " $\frac{1}{300}$ " |
| 7 | " " | " $\frac{1}{200}$ " |
| 1 | " " | " $\frac{1}{100}$ " |
| 5 | did not kill at | $\frac{1}{200}$ " |

4. Other methods.—The methods of Spronck, Park and Williams, Nicolle, and Macé which are in use in some laboratories are less reliable than those given above.

Spronck's first method.—This was based upon the absence of glucose in stale meat.

Prepare 2 per cent. peptone broth in the ordinary way but with meat which has been hanging for some days until it has acquired a slight smell. Make alkaline and then add 0.5 per cent. salt and a little calcium carbonate. Distribute in quantities of 300-400 c.c. in half litre flasks. Sterilize. Sow when cool. Incubate at 37° C. for 3-4 weeks. Filter.

Spronck's later method.—This was based upon a possibly beneficial action of yeast in promoting the production of toxin.

Revive the bacillus by sowing first on coagulated blood serum and then on peptone yeast water (p. 37). Sow from the latter on to a shallow layer of peptone yeast water contained in a large flat flask. After incubating for 24 hours the growth has formed a continuous pellicle on the surface and at the end of a week the content of toxin is at its maximum: a dose of $\frac{1}{700}$ c.c. suffices to kill a guinea-pig. Spronck does not use a porcelain filter but adds 3 grams of carbolic acid per litre and filters through paper.

Massol's method.—Proceed as in Spronck's method but use the following medium:

| | |
|----------------------------|------------|
| High veal, - - - - - | 500 grams. |
| Peptone (Witte), - - - - - | 20 " |
| Water, - - - - - | 1000 " |

Neutralize. Add 7 c.c. normal soda solution. Filter through filter paper. Sterilize by filtration through a Chamberland bougie.

Nicolle's method.—Use beef killed the same morning. Mince the meat. Add twice its weight of water and allow to stand for an hour at 10° or 12° C. Add 2 per cent. peptone and 0·5 per cent. common salt. Heat to boiling point. Filter. Make “sufficiently” alkaline. Heat to 120° C. for 10 minutes. Filter. Distribute in sterile plugged vessels. Heat to 115° C. for 15 minutes.

Grown in this medium for 7 days at 37° C. the diphtheria bacillus will yield, without having a current of air passed over the culture, a toxin quite as powerful as that obtainable by Roux and Martin's method.

Macé's method.—Use ordinary peptone broth containing in addition 10 per cent. calcium carbonate. Distribute in litre or two litre flasks and autoclave. Incubate after sowing for 4–6 weeks at 37° C. The product is said to be equally as toxic as the filtrate prepared by Roux and Martin.

Park and Williams' method.—[*vide ante* Dean's method.] These observers grow the bacillus on ordinary peptone broth made alkaline to the extent of 7 c.c. normal soda solution per litre (p. 31).

Protein-free media.—Utchinsky has shown that it is possible to get toxin by growing the organism on media containing no protein and consisting merely of salts and asparagin (p. 39). Hadley prefers to substitute glyocoll (1 gram per litre) for the asparagin in Utchinsky's medium.

These methods always yield a filtrate very weak in toxin. Nicolle, by adding to Utchinsky's medium peptone Chapoteaut and gelatin liquefied by *B. subtilis*, gets a very powerful toxin.

(b) The testing and storing of toxin.

(a) **The testing of toxin.**—The toxin content of the product manufactured with the same bacillus under apparently identical conditions is subject to considerable variation [*vide* Dean's results, p. 259]. It follows therefore that every sample of toxin must be tested.

To be suitable for the immunization of animals (for the purpose of preparing a therapeutic serum) a toxin must kill a guinea-pig weighing 400–500 grams in 48 hours or less when inoculated in quantities of 0·1 c.c. beneath the skin.

The toxins now used are often much stronger than this so that a dose of $\frac{1}{100}$ or $\frac{1}{200}$ c.c. will kill a guinea-pig weighing 500 grams in 36 hours.

For convenience of comparison Ehrlich has suggested the adoption of a unit of toxin. A unit of toxin is the quantity necessary to kill a guinea-pig weighing 300 grams in 96 hours; and a toxin is said to contain 100, 200 etc. units per cubic centimetre.

For measuring small quantities of toxin it is convenient to make dilutions in sterile water; for example, 1 c.c. of toxin added to 9 c.c. of sterile water gives a dilution of which 1 c.c. represents 0·1 c.c. of toxin. [Similarly 1 c.c. of No. 1 dilution added to 9 c.c. of sterile water affords a dilution of which 1 c.c. represents 0·01 c.c. of toxin.]

(β) **To store toxin.**—For the purpose of storing toxin use sterile [amber-coloured] bottles, which must be exactly filled, well plugged and kept in the dark. Even under these conditions the toxin slowly loses its toxic properties.

(c) Action of toxin on animals.

The symptoms which follow the inoculation of diphtheria toxin into susceptible animals are identical with those produced by the inoculation of living cultures of the diphtheria bacillus. It is immaterial whether the toxin be administered by inoculation beneath the skin, into the peritoneal cavity, into the veins or into the brain. But given by the mouth toxin has no effect whatever.

On the guinea-pig.—If a fraction of a c.c. of toxin (0·1–0·25 c.c.—the exact amount depending upon the toxin content of the filtrate) be inoculated beneath the skin of a guinea-pig an oedema rapidly forms at the site of

inoculation; this is soon followed by panting respiration and death supervenes in 20–30 hours.¹

Post mortem the lesions found are similar to those described as following the inoculation of living bacilli.

Smaller doses (0.005–0.002 c.c.) of a powerful toxin kill guinea-pigs after the lapse of 5–30 days, but if the dose be too small the animal will survive. Paralysis is very rarely seen in guinea-pigs.

On the rabbit.—The administration of 0.25–0.5 c.c. toxin either sub-cutaneously or into a vein terminates in death accompanied by the usual lesions. If the dose be not large enough to kill the animal very rapidly typical diphtheria paralyses develop.

If toxin be applied to mucous membranes, local lesions and occasionally true false membranes form even though the surface be intact (Roger and Bayeux, Morax and Elmassian).

On the dog.—Dogs are very susceptible to the action of diphtheria toxin. A dose of 1 c.c. sub-cutaneously is sufficient to kill a dog rapidly with symptoms of jaundice and diarrhoea; lesions will be found in the liver *post mortem*. Smaller doses are followed by paralyses: the animal may recover but if death takes place it does not occur so rapidly as when larger doses are used.

On birds.—Fowls, pigeons and small birds rapidly succumb to very small doses of toxin whether the inoculation be made beneath the skin or into the pectoral muscle.

Ruminants.—Goats are very susceptible to diphtheria toxin; similarly, cows often succumb to the inoculation of a fraction of a c.c. of toxin. Sheep are somewhat less susceptible.

Horses.—The horse is less affected by diphtheria toxin than ruminants; but a dose of 0.1 c.c. of a toxin of which the lethal dose for guinea-pigs was $\frac{1}{20}$ c.c. has been known to kill a horse weighing 400 kg. The ass is more susceptible.

Rats and mice are nearly immune to the action of toxin when inoculated sub-cutaneously: the dose of toxin required to kill a mouse would kill as many as 24 to 100 guinea-pigs (Roux and Yersin).

On the other hand intra-cerebral inoculation of 0.1 c.c. of toxin kills rats with symptoms of diphtheria paralysis (Roux and Borrel).

The brain of the rat is therefore sensitive to the action of diphtheria toxin, and the reason why the animal does not die as the result of sub-cutaneous inoculation of large quantities of the poison is because the latter is fixed by certain cells in the tissues (probably by the phagocytes), and so never reaches the cerebrum.

(d) On the nature and properties of diphtheria toxin.

The problem of the nature of diphtheria toxin has been the subject of prolonged and extensive investigations. Brieger and Fränkel as well as Wassermann and Proskauer regarded toxin as a tox-albumin, and Gamalèia considered it to be a nucleo-albumin: but these observers only succeeded in obtaining very impure products containing relatively very little toxin. Roux and Yersin have shown that the active principle in filtered cultures has the chief properties of enzymes. A temperature of 100° C. destroys diphtheria toxin: an exposure to a temperature of 58° C. for 12 hours lowers its toxicity to such an extent that 1 c.c. of the heated toxin fails to kill a guinea-pig; and the effect of heating to 70° C. is to attenuate the toxin even more. In common with the diastases, diphtheria toxin has the property of being carried

[Sub-cutaneous inoculation is always followed by an incubation period before symptoms appear.]

down in the precipitates which can be produced in the solutions in which it is dissolved (*Miahle's reaction*).

By adding a solution of chloride of calcium drop by drop to diphtheria toxin phosphate of lime is precipitated as the result of the combination of the calcium with the phosphates present in the liquid. This precipitate when collected on a filter and washed, is very toxic; the sub-cutaneous inoculation of a mere trace of it rapidly causes death in a guinea-pig accompanied by a swelling at the site of inoculation and the formation of a small greyish false membrane. The precipitate is more toxic in the moist than in dry state. Nevertheless after desiccation it retains most of its toxic properties, and in this condition it is more resistant to the action of heat and can be raised to a temperature of 70° C. without losing any of its toxicity; and further a very small amount of the desiccated precipitate if inserted beneath the skin will kill three guinea-pigs in succession if transferred from one animal to the other as each dies.

After filtering off the first precipitate the clear filtrate is still toxic, and precipitates may be produced time after time; every time the precipitate contains toxin but in a progressively diminishing quantity, until finally the filtrate will no longer produce a precipitate though it is still slightly toxic, as is shown by the fact that when inoculated into guinea-pigs in very large doses, it sets up a chronic intoxication.

Diphtheria toxin is soluble in water but again like the diastases is precipitated by alcohol: but precipitation with alcohol diminishes its toxicity.

To precipitate the toxin it is best to evaporate the filtrate first to one-tenth its volume *in vacuo* at 25° C., and then to add to the liquid extract 4-5 volumes of strong alcohol: the toxin mixed with numerous impurities is carried down in the precipitate. Toxin may also be precipitated by ammonium sulphate.

Toxin obtained by filtration can be dried *in vacuo* to the consistency of a dry extract: this extract is soluble in water and contains the true toxin mixed with a very large proportion of impurities. On dialysis the watery solution quickly loses the mineral salts in solution, but the toxin is only removed with great difficulty. This method may be used for purifying diphtheria toxin.

The toxic content of diphtheria toxin is considerable.

1 c.c. of filtered cultures yields 0.01 gram of dry residue: thus, if 0.005 c.c. of filtered culture suffice to kill a guinea-pig the lethal dose of the dry residue is $\frac{0.01}{200}$ gram (0.00005 gram) and of this small quantity the greater part consists of mineral salts, peptone etc. This will give some idea of how infinitely small is the fatal dose of the real toxic substance.

Many chemical substances alter the toxic nature of diphtheria toxin. For instance, toxin is destroyed by peptic ferments, while alcohol, acids, and antipyrin diminish the toxin content. Oxidizing agents, again, are remarkable for the capacity they exhibit of changing its character: thus, hydrogen peroxide, alkaline hypochlorites and especially iodine and iodine terchloride lower its toxicity considerably. The action of these substances is turned to practical account in attenuating toxin which is to be used for the immunization of animals.

4. Vaccination.

(i) In **laboratory animals** it is difficult to produce immunity by repeated inoculation of very small doses of diphtheria toxin because the toxin accumulates and the animals become cachectic and die.

(a) G. Hoffmann was the first to successfully immunize guinea-pigs. He inoculated them first with cultures attenuated by keeping, and later with fully virulent cultures. Subsequently, Behring and Wernicke employed a similar method.

(b) Frænkel immunized guinea-pigs by inoculating them sub-cutaneously with cultures heated for an hour to 65°-70° C.: altogether the animals

received from 10–20 c.c. of these cultures at various times. Immunity was acquired at the end of 14 days.

(c) Behring in immunizing guinea-pigs and rabbits used the pleural fluid obtained from guinea-pigs which had succumbed to the inoculation of virulent cultures. Immunity was acquired in about a fortnight after the inoculation of the vaccine, but the results were very inconstant.

(d) Behring immunized guinea-pigs and sheep by inoculating them with cultures 3 weeks old and to which 1 part of iodine terchloride had been added to 500 parts of culture. A few c.c. of this mixture were inoculated into an animal and then 10 days or so later a second inoculation was given of a culture to which a smaller quantity of iodine terchloride had been added. Immunity was acquired in about a fortnight. This method fails in the case of the rabbit.

(e) Brieger, Wassermann and Kitasato conferred immunity on guinea-pigs by inoculating them on several occasions with 2 c.c. of a culture on thymus broth warmed to 70° C. for 15 minutes. But this method is not so effective as the iodine terchloride method of Behring.

(ii) Roux, Nocard and Martin succeeded in immunizing various animals (rabbits, sheep, goats, cows, horses) by inoculating them first with a virulent toxin mixed with Gram's iodine solution, then with gradually increasing doses of pure toxin.

A rabbit, for example, was inoculated sub-cutaneously in the first instance with 0.5 c.c. of the following mixture which was prepared immediately before use.

| | | | | | | |
|-----------------------------------|---|---|---|---|---|---------|
| Toxin (Roux and Martin's method), | - | - | - | - | - | 2 vols. |
| Gram's iodine solution, | - | - | - | - | - | 1 vol. |

The injection was repeated every few days for some weeks, then the proportion of iodine was gradually diminished and last of all pure toxin was inoculated. The animals were weighed at frequent intervals and if they showed any loss of weight the inoculations were stopped for the time being, otherwise they died of cachexia.

Goats and cows may be immunized in a similar manner, but these animals being very susceptible to diphtheria toxin, very small doses of iodized toxin must be used for the initial inoculations, and pure toxin should only be given when the blood shows some content of antitoxin. It should be borne in mind that pregnant animals are more susceptible to diphtheria toxin than non-pregnant animals.

Horses stand toxin well and especial interest attaches to the immunization of these animals because they are the source whence antitoxin for therapeutic purposes is derived.

The horses selected should be young (6–9 years old) well fed and free from disease. After having been tested with mallein to exclude a possible infection with glanders (*vide* Glanders) [and with tuberculin to exclude tuberculosis] the horse is inoculated in the first instance with a small quantity of a virulent toxin to which Gram's iodine has been added: at subsequent inoculations the doses are gradually increased, and after the eighth inoculation pure toxin is used: different animals vary enormously in susceptibility, and care should always be taken that the dose used in the initial experiment shall be so small that no violent reaction results, as this might imperil the steady progress of the immunizing process. The injections should be made sub-cutaneously into the neck or behind the shoulders.

The following table exhibits an actual record of the immunization of an horse by Roux and Nocard.

Horse, 7 years old and weighing about 400 kg.

The iodized toxin contained one-tenth its volume of Gram's solution. The toxin used killed guinea-pigs weighing 500 grams in 48 hours in doses of 0.1 c.c. The injections were made beneath the skin of the neck or behind the shoulder.

1st day of experiment. Injection of 0.25 c.c. of an iodized toxin. No local nor general reaction.

- 2nd day of experiment. Injection of 0·5 c.c. of an iodized toxin. No local nor general reaction.
- 4th, 6th, and 8th days of experiment. Injection of 0·5 c.c. of an iodized toxin. No local nor general reaction.
- 13th and 14th days of experiment. Injection of 1 c.c. of an iodized toxin. No reaction.
- 17th day of experiment. Injection of 0·25 c.c. of a pure toxin. Slight œdema. No rise of temperature.
- 22nd day of experiment. Injection of 1 c.c. of a pure toxin. Slight œdema. No rise of temperature.
- 23rd day of experiment. Injection of 2 c.c. of a pure toxin. Slight œdema. No rise of temperature.
- 25th day of experiment. Injection of 3 c.c. of a pure toxin. Slight œdema. No rise of temperature.
- 28th day of experiment. Injection of 5 c.c. of a pure toxin. Slight œdema. No rise of temperature.
- 30th, 32nd, and 36th days of experiment. Injection of 5 c.c. of a pure toxin. Slight œdema. No rise of temperature.
- 39th and 41st days of experiment. Injection of 10 c.c. of a pure toxin. Slight œdema. No rise of temperature.
- 43rd, 46th, 48th and 50th days of experiment. Injection of 30 c.c. of a pure toxin. Fairly well marked œdema which vanished in 24 hours.
- 53rd day of experiment. Injection of 60 c.c. of a pure toxin. Fairly well marked œdema which vanished in 24 hours.
- 57th, 63rd, 65th, and 67th days of experiment. Injection of 60 c.c. of a pure toxin. Fairly well marked œdema which vanished in 24 hours.
- 72nd day of experiment. Injection of 90 c.c. of a pure toxin. Fairly well marked œdema which vanished in 24 hours.
- 80th day of experiment. Injection of 250 c.c. of a pure toxin. Fairly well marked œdema which vanished in 24 hours.

This horse therefore had received in 2 months and 20 days 800 c.c. of toxin, without showing any symptoms other than a transient local œdema, some loss of appetite and a rise of temperature of about 1° C. on the evenings following the larger injections. The animal was bled on the 87th day and was inoculated into the jugular vein with 200 c.c. of toxin without showing any reaction.

Vaccinated horses withstand equally well enormous doses (many hundred cubic centimetres) of living cultures.

As has been pointed out some horses are more susceptible to diphtheria toxin than others, and in the more susceptible individuals an extensive, firm œdema lasting many days may follow inoculation, and in some cases, the horse may sweat and show a marked rise of temperature.

Occasionally a highly immunized horse will die of paralysis 1-3 weeks after the last inoculation of toxin.

With the very powerful toxins at present in use immunization should be carried out still more carefully. With a toxin containing 200 units of toxin per c.c. horses should be inoculated three times a week for 6 weeks with a mixture of toxin and Gram's solution (commencing with a mixture consisting of 2 parts Gram's solution and 1 part toxin), then with toxin alone in progressively increasing doses: the initial dose being 0·5 c.c. and the final inoculation 200 c.c.

When small doses are inoculated at frequent intervals the antitoxic content of the serum is greater than when large doses are given at longer intervals (Roux).

To maintain horses in a state of immunization it is necessary to inoculate a dose of toxin from time to time: this may be done in different ways.

1. After bleeding a horse 300-500 c.c. of culture may be inoculated at intervals of 20 or 25 days into the jugular vein.

2. At the Pasteur Institute Martin inoculates beneath the skin of the shoulder, 13 days after bleeding the animal, 300 c.c. of toxin; and 4 days later on the opposite side—also sub-cutaneously—a further 500 c.c. The horse may be bled again a week after the last inoculation.

3. Another method is to inoculate sub-cutaneously every 2 or 3 days for 3 weeks quantities of toxin increasing from 25–150 c.c. until about a litre has been injected. The animal is bled 12 days after the last inoculation of toxin.

(iii) Horses may also be immunized by inoculating them with a mixture of antidiphtheria serum and toxin (Babès, Madsen and Dreyer, Park). The yield of antitoxin is good and the method is more rapid than the iodine terchloride method (Park).

The following table shows the details of an experiment by Martin.

Inoculations twice a week. Toxin killed guinea-pigs weighing 500 grams in 36 hours in doses of 0.1 c.c. Antidiphtheria serum contained 200 units per c.c.

| | | | | | |
|------------------|---|---|---|---|--------------------------------|
| 1st inoculation, | - | - | - | - | 25 c.c. serum + 25 c.c. toxin. |
| 2nd " | - | - | - | - | 10 " " + 25 " " |
| 3rd " | - | - | - | - | 25 c.c. pure toxin. |
| 4th " | - | - | - | - | 40 " " |
| 5th " | - | - | - | - | 60 " " |
| 6th " | - | - | - | - | 80 " " |
| 7th " | - | - | - | - | 100 " " |
| 8th " | - | - | - | - | 150 " " |
| 9th " | - | - | - | - | 200 " " |
| 10th " | - | - | - | - | 250 " " |
| 11th " | - | - | - | - | 300 " " |
| 12th " | - | - | - | - | 350 " " |
| 13th " | - | - | - | - | 400 " " |
| 14th " | - | - | - | - | 450 " " |
| 15th " | - | - | - | - | 500 " " |

5. Serum therapeutics.

Antitoxin.

Behring and Kitasato in 1890 were the first to demonstrate the antitoxic properties of the blood of animals immunized against diphtheria.

These observers found that the blood of immunized animals had the property of destroying diphtheria toxin both *in vivo* and *in vitro*; that this property was also present in the serum of blood deprived of all cellular elements; and that the serum was both therapeutic and prophylactic when used on rabbits and guinea-pigs intoxicated with diphtheria toxin or inoculated with living diphtheria bacilli.

Having established these facts Behring, Ehrlich, and their collaborators turned their attention to the application of antidiphtheria serum to the treatment of human diphtheria (Behring, Ehrlich, Boer, Wassermann, Rossel). But the serum treatment of diphtheria did not become an accomplished fact in medical practice until after the Congress of Hygiene at Buda-Pesth in 1894 when Roux and Martin communicated a summary of the work they had carried out during the years 1891-4.

(a) Preparation of the serum.

The horse is chosen as the source of antitoxin for these reasons, viz. :— Horse serum, even in large doses, is innocuous to man and to the lower animals; horses withstand the action of diphtheria toxin very much better than other animals; lastly, very large quantities of serum are available (Roux; Nocard and Martin).

The immunization of the horse which is carried out as described above generally occupies about 3 months. In practice toxin is inoculated in gradually increasing doses until some 1000–1500 c.c. have been administered: the final inoculations should consist of quantities of 150–200 c.c.

The animal is bled 8–10 days after the date of the last inoculation: about 6 litres of blood are withdrawn and a further quantity may be taken a few days later. It is best to bleed the horse from the jugular vein according to

the directions given on pp. 49 and 50 (Nocard's method and Latapie's apparatus). Six litres of blood yield nearly 4 litres of serum.

The horse is maintained in a state of immunization by the inoculation of toxin from time to time.

When several animals have been immunized it is highly desirable that the serum of the various horses should be mixed; by doing this a product is obtained of which the antitoxin content is uniform. Moreover, the serum of some horses is liable to provoke erythematous rashes when used in the human subject, which though harmless are nevertheless irritating, and by mixing different serums this inconvenience may be minimized.

For the purpose of storing serum it is distributed with aseptic precautions in small sterile bottles stoppered with sterile india-rubber plugs and kept in the dark.

Serum prepared under strictly aseptic precautions may be kept in these climates many months in a sterile condition without losing any of its antitoxic properties. Occasionally the serum after bottling becomes distinctly cloudy, but this is of no importance with respect either to the purity or efficacy of the serum. A deposit is less likely to occur and the keeping property of the serum is better assured if, immediately after filling, the bottles are heated for an hour at 57° C. in a water bath. This degree of heat has no effect upon the properties of the serum.

Dried serum.—Serum may be dried by evaporation *in vacuo*. Just before use the dried serum is dissolved in eight or ten times its volume of sterile water; this solution frequently gives rise to a local but transient swelling which is not the case with liquid serum. In these latitudes liquid serum should always be administered in preference to the dry product: the value of the latter is apparent in warm climates where liquid serum quickly loses its properties.

Antitoxic milk.—The milk of immunized females possesses antitoxic properties (Ehrlich). This fact however is merely of theoretical interest because the extreme dilution of the antitoxin in the milk renders the latter incapable of being used in practice.

Still, milk containing antitoxin may be condensed to a sufficiently small volume to allow of laboratory experiments being conducted with it (Wassermann). The milk of cows or goats can be used; for experimental purposes it is scarcely possible to get a milk with a preventive strength of one-fifth (*vide infra*, p. 268).

(b) Properties of the serum.

The serum of immunized animals is antitoxic, that is to say if the serum be mixed with toxin in suitable quantities the mixture is harmless on inoculation into animals.

This property of the serum is due to a special substance known as *Antitoxin*, the nature of which is as little understood as is the nature of toxin: like toxin, antitoxin is altered by heat, precipitated by alcohol and carried down with the precipitates formed in liquids which contain it in solution. In the living body it is formed in response to the absorption of toxin; "under the influence of toxin, certain cells of the living body acquire a new and persistent secretory property" (Salomonson and Madsen).

Antitoxin saturates toxin both *in vivo* and *in vitro* (p. 224): it has both *prophylactic* and *curative* properties: a guinea-pig inoculated with an adequate dose of serum can withstand the subsequent inoculation of such a quantity of toxin as would be sufficient to kill with certainty a non-inoculated guinea-pig. Even if the toxin be inoculated first and the serum not until several hours later, the animal will be protected. Immunity is rapidly produced but is short-lived: in a few days or weeks it has entirely disappeared. The amount of serum necessary to cure an animal inoculated with toxin depends upon many factors: among others upon the weight of the animal, the amount

and toxicity of the toxin used and upon the antitoxic strength of the serum. It is very important to know the antitoxic strength of the serum used, and rules have been devised by which this may be determined (*vide infra*).

Antitoxic serum is *not bactericidal* and contains *no immune body (sensibilisatrice)*; it has some power of *agglutinating* the bacillus but only in a feeble and inconstant manner. For instance, it may agglutinate in dilutions of 1 in 10 and 1 in 20 and the agglutination is sometimes visible to the naked eye, flocculi falling to the bottom of the tube (Nicolas); on the other hand agglutination is often absent. The serum also of patients suffering from diphtheria sometimes shows some slight property of agglutination (Bruno).

Bacilli recently isolated from the living subject are often unaffected or but slightly affected by the specific agglutinin; prolonged sojourn in artificial culture, however, seems to develop or increase the power of being agglutinated. It is important in testing the agglutinating properties to use a good emulsion of bacilli, and for this purpose a culture in 2 per cent. glucose broth, which is generally cloudy, is suitable. Martin recommends collecting the bacilli from flasks which have been used for toxin preparation and heating them to 100° C. For use, shake up these bacilli well with normal saline solution and let the emulsion stand: a large number of the bacilli will deposit, but the supernatant liquid remains cloudy permanently and serves very well for the agglutination reaction.

Antitoxic serum is both *prophylactic* and *therapeutic* in the case of animals inoculated with a *living culture* of the diphtheria bacillus: the therapeutic properties are exhibited even if the serum be not administered until 12 or 18 hours after the virus.

In the case of a guinea-pig which has been inoculated with a living culture on the mucous membrane of the trachea or vulva, the inoculation of serum, even though it be administered before the virus, will not prevent the formation of the characteristic false membrane, but does entirely prevent symptoms of intoxication or of disturbance of the general health of the animal: and further the false membrane becomes detached on the second day and the infected surface commences to heal. If instead of being inoculated before the living virus, the serum be administered after the false membrane has formed, it leads to the disappearance of the œdema and swelling in a few hours and after two days to the casting off of the false membrane.

The false membranes formed in the trachea of the rabbit as the result of infecting the mucous membrane with a mixture of *streptococci* and *B. diphtheria*, are not so readily affected by antitoxic serum. In such a case 5, and even 10 c.c. of antitoxin are insufficient to save the life of the animal: but Roux and Martin have been able to effect a cure in parallel cases by repeating the inoculation of antitoxin several times.

Roux and Martin have tested the value in these cases of mixing antistreptococcal and antidiphtheria serums, but with only moderately successful results (*vide The Streptococci*).

(c) The standardization of antitoxin.

1. Behring estimated the antitoxic content of an antiserum in terms of the amount of the serum necessary to immunize 1 gram weight of animal against the minimal fatal dose of toxin inoculated 12 hours after the serum.

Thus, for example, if 1 c.c. of a serum immunized 1 kg. weight of guinea-pig against the inoculation 12 hours later of the smallest dose of toxin which would kill a control animal of the same weight within a given time the serum was said to have a strength of $\frac{1}{1,000}$. This method of titration is not very exact but it has the advantage of being simple.

2. Behring then altered his test inoculation. Instead of toxin he used living bacilli and measured the value of the serum against an infection and not against an intoxication. The unit of serum, now, was the amount necessary to immunize 5,000 grams of guinea-pig (or 10 guinea-pigs of 500 grams each) against the inoculation 24 hours later of ten times the amount of a forty-eight-

hour old culture of the diphtheria bacillus which was certainly fatal to control animals.

[Thus if 0.01 c.c. of a serum would immunize a guinea-pig weighing 500 grams against 10 times the lethal dose of a 48 hour old culture of a virulent diphtheria bacillus, it follows that 0.1 c.c. would be required to immunize 5,000 grams. That amount then was the unit and 1 c.c. of the serum would contain 10 units.]

3. Ehrlich adopted another unit of measure. The **unit of antitoxin (I.E.)** is the amount of antitoxin necessary to neutralize 100 minimal lethal doses of normal toxin (*i.e.* of a toxin which is fatal to guinea-pigs in doses of 0.1 c.c.). Thus if 0.01 c.c. of a given serum neutralizes 100 fatal doses of toxin that serum is said to contain 100 antitoxic units per c.c.

It was difficult to get comparable results by this method because the toxicity of a given toxin diminishes with the lapse of time. On the other hand the antitoxin content of a carefully standardized serum dried *in vacuo* and without heating is known to remain constant almost indefinitely. Ehrlich therefore having determined an antitoxic unit (as above) prepares a glycerin solution of the serum containing 17 units per c.c. This preparation is now used in antitoxin laboratories as the standard for testing serums. One c.c. of Ehrlich's glycerin solution diluted with 16 c.c. of water gives a solution containing 1 unit of antitoxin per c.c.

It is then easy to titrate a toxin against the standard antitoxin and after standardizing the toxin very carefully the latter is used to titrate the antitoxin under investigation.

4. **The French method of standardizing antitoxin.**—Roux prefers to standardize antitoxin according to its preventive strength (*pouvoir préventif*). The **preventive strength** is the numerical ratio between the weight of a given animal—guinea-pig—in grams and the amount of serum necessary to save its life if it be inoculated 12 hours later with 0.5 c.c. of a young and highly virulent culture. For example, if the guinea-pig weigh 500 grams and 0.1 c.c. of serum has to be inoculated to protect it against the subsequent inoculation of culture the preventive strength is $\frac{0.1}{500}$, and the serum is said to be active in $\frac{1}{5,000}$.¹

In practice the Ehrlich and Roux methods may usefully be controlled against each other; for instance, a serum is said to contain 100 antitoxic units per c.c. and to have a preventive strength of $\frac{1}{50,000}$. It must be borne in mind however, that the maximum of preventive strength may not coincide with the maximum of antitoxic strength (Martin, Momont and Prévot).

A serum which has a preventive strength of $\frac{1}{50,000}$ is suitable for the treatment of diphtheria in man, but a more powerful serum ($\frac{1}{70,000}$ or even $\frac{1}{100,000}$) is easily prepared. The serum made at the Pasteur Institute with the older toxins contained 100 antitoxic units per c.c. and had a preventive strength of $\frac{1}{50,000}$; but at the present time, using toxins prepared by growing the bacillus in Martin's broth which are ten times stronger than the older toxins, the serum supplied contains at least 200–300 antitoxic units per c.c. and has a preventive strength of $\frac{1}{100,000}$.

(d) Serum therapeutics.

The application of serum therapy to the treatment of diphtheria in the human subject has yielded results which might have been expected from animal experiment. The serum therapy of diphtheria is one of the most striking successes of modern therapeutics.

¹ Animals treated in this way do not survive indefinitely but die generally in from 1–6 months (Roux).

The serum is inoculated in doses of 10–40 c.c., either in one dose or at different times according to the severity of the disease: the technique of administration need not be dealt with here.

The serum has been used as a prophylactic during epidemics of diphtheria; the immunity so produced is only of short duration and varies from 3–6 weeks. The dose to be used as a prophylactic should be 5–10 c.c. (Roux).

6. Agglutination.

Antitoxic serum obtained by the inoculation of toxin possesses, as has been pointed out, no agglutinating properties and contains no immune body (*substance sensibilisatrice*). By the inoculation of the bacilli themselves a serum containing both agglutinins and immune body can be obtained. Wassermann, Bandi, Martin, thought that such a serum might be of use in clinical practice to facilitate the disappearance of diphtheria bacilli from the pharynx of those cases in which it remained an unduly long time even after the use of antitoxin.

(i) Wassermann inoculated into the veins of a rabbit an extract of bacilli to which antitoxin had been added to neutralize the toxin. After several inoculations the serum of the rabbit precipitated the bacillary extract and agglutinated the diphtheria bacillus.

It would not appear to be true, as Wassermann thought, that this serum can be used to differentiate the pseudo-diphtheria from the diphtheria bacillus. As Lipstein points out, a serum obtained by the inoculation of a given strain of bacilli may agglutinate that strain in high dilution, while having no effect whatever on other strains.

(ii) Lipstein obtained a serum which agglutinated the diphtheria bacillus in a dilution of 1 in 1,000 by inoculating into the peritoneal cavity of a rabbit first a mixture of dead bacilli and antitoxin and later a mixture of living bacilli and antitoxin. This serum has no prophylactic properties.

(iii) Bandi inoculated a dog sub-cutaneously several times during the course of a month with sensitized diphtheria bacilli—bacilli, that is, which had been treated with antitoxin and had then been washed and centrifuged to remove any excess of serum. This observer obtained a serum which besides possessing agglutinating and sensitizing properties was also feebly antitoxic (15 units per c.c.). He had good results in seven cases of diphtheria which he treated with the serum.

(iv) Martin also prepared a serum which exhibited agglutinating, sensitizing and immunizing properties. The serum was obtained from a horse by inoculating it sub-cutaneously, intra-peritoneally, or better into the veins with bacilli which had been heated to 100° C. for an hour. Martin treated a number of cases of diphtheria locally with this serum. Repeated application to the false membranes gave very little result—some diminution of pain—but by making it into pastilles with gum and so ensuring a more prolonged contact with the membrane the results were more satisfactory. Under these conditions the false membranes swelled up, became softened and were soon detached. Cultures showed a rapid and marked diminution in the number of bacilli.

SECTION IV.—DETECTION, ISOLATION, AND IDENTIFICATION OF THE DIPHTHERIA BACILLUS.

The diagnosis of diphtheria is often impossible by clinical methods alone; hence in practice the nature of the infecting agent in all cases of croup and

sore throat, especially if any trace of a false membrane be present, has to be determined by bacteriological investigation.

By this means it can be ascertained whether any given case of croup or sore throat be the result of an infection with the diphtheria bacillus either alone or in association with other organisms. If a diphtheria bacillus be found, its virulence should be ascertained; but this is not a matter of great importance in practice, because as a rule it may be assumed that the long bacillus is the most virulent of all the varieties of the diphtheria bacillus—and so the virulence of the strain under examination may be gauged from the relative number, or entire absence, of such forms—and because from the point of view of treatment the mere fact that the diphtheria bacillus has been found demands the administration of antitoxin.

When dealing with a case of sore throat three investigations are necessary before the bacteriological examination can be said to be scientifically complete. First films from the inflamed surface must be examined, then cultures must be sown with the material from the throat, and lastly the causal organism must be isolated and injected into an animal. In clinical work, however, the two former investigations are all that is required and these occupy 24 hours at the outside.

1. Collection of the material.

Remove the false membrane on a small piece of absorbent cotton-wool fixed in a pair of pressure forceps: in those cases in which the membrane is very adherent it is better to tear it off with the forceps. For the collection of material in the ordinary way it is convenient to have a small cotton-wool plug fixed on the end of a metal rod; this is placed in a test-tube which is then plugged with wool and the whole sterilized in the hot air sterilizer. If there be no membrane scrape the surface of the tonsils or pharynx with a small platinum or nickel spatula.

When it is desired to send a fragment of false membrane to a laboratory situated at a distance, place it in a small sterilized tube plugged with wool; or wrap it in a piece of thin cloth which has been passed through boiling water and then place it in a new glass tube carefully plugged.

Most laboratories send the necessary apparatus for the collection of material to practitioners. A convenient form is that which contains two sterilized plugs in test-tubes, a sterile tube for false membrane and a small spatula, as well as two tubes of serum.

2. Methods of examination.

A. Microscopical examination of the fresh material.—This part of the investigation is of considerable importance.

Before using the false membrane for bacteriological examination press it lightly between sterile filter-paper to blot up any mucus which may be present on the surface.

1. Prepare films with small portions of the exudate, and stain with Roux's blue, wash and dry. Examine with an oil immersion lens. [Cobbett's method (p. 252) is recommended as giving more characteristic appearances.]

The absence of the diphtheria bacillus must not be assumed if the microscopical examination be negative as it is a well known fact that it often passes unrecognized when mixed with a number of other organisms (Martin).

Should bacilli resembling diphtheria bacilli be found in the preparation, the diagnosis may be advanced a stage by staining other films by Gram's method. The diphtheria bacillus is gram-positive, and a certain number of bacilli frequently found in the mouth and morphologically resembling it, but gram-negative, can by this means be excluded.

Cultures must be sown in every case.

One or two important inferences may be drawn from the result of microscopical examination, when positive. As a rule, the finding of numerous bacilli of the "long" type denotes a severe infection, and a similar inference may be drawn if streptococci are found associated with the specific micro-organism. On the other hand the presence of the Brisou coccus generally indicates a mild infection.

2. Sections.—Harden in alcohol, embed in paraffin and cut sections perpendicularly to the surface of the membrane. For staining, Gram's method with double counterstain gives very good preparations.

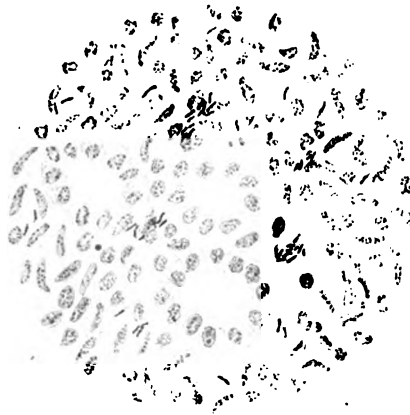

FIG. 171.—Section of tracheal membrane from a case of diphtheria, showing diphtheria bacilli (Eosin and methylene blue), oc. 2; obj. $\frac{1}{4}$ th, Zeiss.

From an histological study of diphtheria membranes it can be shown that they are made up of three layers: the deepest layer—that next the body surface (mucous membrane or skin)—consists of a network of fibrin enclosing epithelial cells and leucocytes: the middle layer is made up of granular fibrin with but few cellular elements, while the most superficial layer consists almost entirely of micro-organisms; the bacilli, many of which are swollen at the ends, are arranged in masses parallel to one another, and side by side with the diphtheria bacillus are found the organisms associated with it.

B. Cultures.—Cultures should be sown on coagulated blood serum. If however this medium be not available, white of egg may be used instead.

The various serum media of Loeffler, Tochtermann, Joos, etc., give no better results than coagulated blood serum while they have the disadvantage of needlessly complicating the technique. [Many observers, however, state that Loeffler's serum (p. 52) is by far the best medium for the cultivation of the diphtheria bacillus.

[Lorrain Smith prepared a transparent serum medium by adding 0.1 per cent. to 0.15 per cent. of caustic soda to ox serum and heating the mixture at 120° C.

[Cobbett added about 1 c.c. of a 10 per cent. solution of caustic soda to 100 c.c. of ox or horse serum and after thoroughly mixing added 1 per cent. of glucose and sterilized at a temperature of 87° C.]

[Coplans has recently introduced the following medium for the routine recognition of the diphtheria bacillus:

| | | | | | | | | | | |
|--|---|---|---|---|---|---|---|---|------|-----------|
| Sheep's serum, | - | - | - | - | - | - | - | - | 75 | parts. |
| Broth, | - | - | - | - | - | - | - | - | 25 | " |
| Glucose, | - | - | - | - | - | - | - | - | 0.5 | per cent. |
| KCNS., | - | - | - | - | - | - | - | - | 1 | " |
| CaCl ₂ , | - | - | - | - | - | - | - | - | 1 | " |
| 1 per cent. aqueous solution of neutral red, | - | - | - | - | - | - | - | - | 0.25 | " |

[The medium is adjusted so that on coagulation the reaction is but faintly alkaline. When throat swabs are sown on surface slopes and incubated at 37° C. for 18 hours, colonies of the diphtheria bacillus appear almost invariably to yield a bluish-pink tint, with diffusion of like tint through the medium; with Hofmann's bacillus the growth is yellowish and alkaline with diffusion of a yellowish tint. Staphylococci usually yield a straw-coloured raised growth with discrete colonies, but certain varieties produce either discrete pink colonies with strictly local diffusion of tint into the medium; and again, other varieties, more especially such as are derived from the throats of adults, yield acid with pink colouration of the medium in varying intensity. The colonies of *torulæ* are usually raised and straw-coloured but they may be brownish or red.]

Sow a tube of blood serum with a small piece of membrane held in a platinum loop and after rubbing it all over the surface of the serum and without recharging the loop sow two other serum tubes (p. 82 B 1). In the absence of membrane the spatula or cotton-wool swab, as the case may be, which has previously been applied to the tonsils or pharynx is rubbed over the surface of the serum. Should the cotton-wool swab be dry on arrival at the laboratory wash it in a little sterile water and then use the latter for sowing cultures. Dried membranes should similarly be softened in sterile water before being sown.

Incubate the cultures at 37° C. and examine about 20 hours later: colonies of the diphtheria bacillus are easily recognized at this stage; some cocci indeed produce a very similar growth but it is moister and more homogeneous than that of the diphtheria bacillus. A mere naked eye examination of the growth is however insufficient, and must always be supplemented by microscopical examination. If examination of the cultures be delayed beyond 24 hours difficulty may arise from the development of micro-organisms which are either associated with the diphtheria bacillus or which are present as an impurity. Select the culture which shows the greatest number of discrete colonies.

[In examining cultures sown with swabs from infected throats Cobbett picks off single colonies one by one with a straight platinum wire, sows a separate tube of broth with each colony, and then smears the wire in a straight line across a cover-glass. The first colony is smeared along one edge of the cover-glass, the others at right angles to it. In this way not only is it possible to make 4 to 9 separate preparations on one cover-glass from the different colonies of a single culture-tube, but pure cultures of each colony also are available for further examination.]

A diagnosis of diphtheria [infection] must be given in all cases in which colonies consisting of organisms having the morphological appearance and giving the staining reactions of the diphtheria bacillus are found on the serum sown with the suspected material. [In cases of faucial diphtheria such colonies will generally be present in large numbers; in laryngeal diphtheria they are sometimes few in number—this is often the case also with convalescents and “contacts.”]

C. Inoculations.—When absolute confirmation of the positive microscopical and cultural results is desired resort must be had to animal inoculation. Several of the suspected diphtheria colonies must be inoculated, because bacilli of different degrees of virulence may be present in the same membrane.

Each colony is dealt with as follows: Sow a portion of a colony in broth (taking every care that the needle touches no other colony), incubate for 24 hours, and after verifying the purity of the culture inoculate 1 c.c. subcutaneously into an adult guinea-pig: the animal dies more or less rapidly according to the virulence of the organism (p. 247). Should the organism prove non-virulent for the guinea-pig test it on a small bird in a similar manner.

[3. Summary of diagnostic tests.]

[As some difficulty may be experienced in differentiating the diphtheria bacillus from other organisms—and especially from Hofmann's bacillus—it will be convenient to summarize the purely specific characteristics of the organism: references are given to the pages on which these characteristics are discussed in detail and also to the pages on which the reactions under similar circumstances of Hofmann's bacillus are considered: the reader will thus be in a position readily to form a diagnosis.

The true diphtheria bacillus is characterized by its:

(α) Macroscopic growth on serum and morphology (p. 250 diphtheria bacillus: and p. 273 Hofmann's bacillus).

(β) Power of producing acid in glucose broth (pp. 256 and 274).

(γ) Invisible growth on potato (p. 254).

(δ) The lesions produced in inoculated guinea-pigs (pp. 247, 255 and 274).

Bacillus pseudo-diphtheria.

(Hofmann's bacillus.)

In the mouths of healthy persons and in some cases of non-diphtheritic sore throat a non-virulent bacillus described by Loeffler as the pseudo-diphtheria bacillus is, as has already been indicated, not infrequently present.

[According to Graham-Smith, Hofmann's bacillus is most commonly found in the throats of the poorer classes, especially the scholars in the public schools (51 per cent. to 56 per cent.). The children attending better-class schools are less commonly found to harbour this bacillus in their throats (8 per cent. and 15 per cent.). In adults the extent of infection is less than in children, but it is greater amongst the poor (20 per cent.) than amongst the well-to-do (9 per cent.).]

This organism is by some observers (Loeffler, Hofmann, [Cobbett] and others) sharply differentiated from the diphtheria bacillus, while others (Roux and Yersin) have brought forward arguments in favour of its identity with the diphtheria bacillus: in the view of the latter school the pseudo-diphtheria bacillus is merely a diphtheria bacillus devoid of virulence (see also pp. 274 and 275).

[**Morphology.**—When taken from young serum or alkalinized glucose serum cultures, stained with a weak solution of Loeffler's blue and mounted in the stain, the bacillus of Hofmann exhibits great uniformity of type; it is oval, stains deeply, has no granules, but shows one unstained septum. The arrangement too is quite different from that of the diphtheria bacillus: Hofmann's bacillus ranges itself in parallel groups resembling a paling. Occasionally the organism departs from this typical form, and numerous many-banded forms occur; on sub-culture however these many-banded forms revert to the type already described.

[**Staining reactions.**—Stained with a weak solution of Loeffler's blue and mounted in the stain, the organism will be found to be a deeply and uniformly stained oval bacillus with one unstained septum. On running a drop of acetic acid (5 per cent.) under the cover-glass

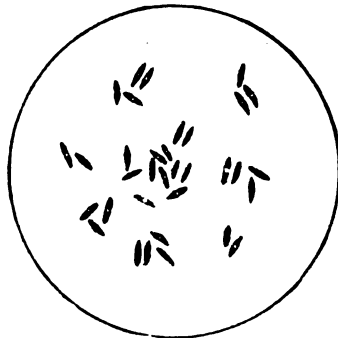

FIG. 172.—Hofmann's bacillus from a young serum culture (18 hours). Mounted in dilute Loeffler's blue (1 in 5 with water). Oc. 4, obj. 4th, Zeiss.

the whole organism decolourizes. (Occasionally a minute granule may be seen at the poles of some of the bacilli, but these minute specks present a very different appearance to the granules seen in the diphtheria bacillus, and are relatively few in number.) If stained with Neisser's blue, washed in water and counterstained with Bismarck brown (1 minute in each stain) the bacilli will be stained uniformly brown; blue granules will be absent or very indistinct.

[The organism like the diphtheria bacillus retains the violet by Gram's method.

[Cultural characteristics.—On serum or alkalized glucose serum the growth is more rapid than that of the diphtheria bacillus, and the colonies are larger and whiter and do not take up the pigment in the serum.

[Bio-chemical reactions.—When grown for 48 hours in a nutrient broth neutral to litmus and containing 1 per cent. glucose no acid is formed; on the contrary a slight increase in alkalinity takes place.]

Rothe recommends the following medium.—

| | |
|---|---------------------|
| Neutral broth, | 1 part. |
| Ox serum, | 4 parts. |
| 10 per cent. glucose litmus solution, | $\frac{1}{2}$ part. |

Solidify.

The diphtheria bacillus on the other hand turns this medium red.

[Virulence.—A guinea-pig inoculated with 2 c.c. or more of a 48-hour culture in broth remains perfectly well, not even a local oedema resulting.

[Immunity.—Hofmann's bacillus produces no substances toxic to laboratory animals. Petrie experimenting with Hofmann's bacillus finds that "no substances capable of neutralizing diphtheria antitoxin are present in the filtrates of the pseudo-diphtheria bacillus"; and his attempts to immunize horses with this bacillus against diphtheria toxin were negative.]

The relation of Hofmann's bacillus to the diphtheria bacillus.—[Petrie's experiments on immunity accentuate the differences between the two organisms—which have been detailed above—and diminish the probability that they stand in close relation to each other.

[Further support of the latter view is afforded by the fact that no satisfactory evidence of the conversion of the one organism into the other has yet been brought forward, though numerous experiments have been conducted for that purpose.

[The non-identity of the diphtheria bacillus with Hofmann's bacillus receives further confirmation from certain practical observations. In the first place, as has already been shown, the distribution of the diphtheria bacillus is limited to the throats of those who have been in contact with cases of diphtheria or with diphtheria-infected contacts, while Hofmann's bacillus is a widely distributed organism present in the throats of a considerable proportion of the ordinary healthy population. Secondly, Cobbett successfully stamped out two epidemics of diphtheria, one at Colchester and one at Cambridge, by isolating only those in whose throats diphtheria bacilli were found, those who harboured the bacillus of Hofmann and no diphtheria bacilli being treated as non-infected individuals. Other observers have had similar experiences.

[The above then is the case of those who regard the Klebs-Löffler and Hofmann's bacillus as distinct species.

[The following arguments, which are advanced in favour of the identity of the two organisms, may be prefaced by a quotation from Graham-Smith supporting an earlier statement to the same effect by Cobbett. "The authority of Roux (1890) whose opinion justly carries great weight has often been quoted in support of the

idea that Hofmann's bacillus is related to the diphtheria bacillus. But this is not right, for his remarks on the pseudo-diphtheria bacillus were made in comparatively early days, when the importance of acid production had not been generally recognized and before Hofmann's bacillus had been clearly distinguished from the so-called non-virulent diphtheria bacillus."]

A. From the morphological point of view the differences between the two organisms are insignificant. The pseudo-diphtheria bacillus is as a rule shorter than the diphtheria bacillus but Martin has shown that this is not always the case: the length of the diphtheria bacillus is subject to great variation and the variations in length afford in some degree an index of its virulence.

Too great importance must not be attached to certain characteristics said to be possessed by the pseudo-diphtheria bacillus by those who consider it a distinct species, and the constancy of which have not been confirmed. Deguy, for instance, says that the pseudo-diphtheria bacillus is motile (?); according to Barbier it shows no granules and stains more deeply than the diphtheria bacillus by Gram's method, etc. Characteristics based upon the staining of the metachromatic granules are of no value whatever for purposes of identification (p. 252).

B. The pseudo-diphtheria bacillus occasionally produces an oedema at the site of inoculation when inoculated into guinea-pigs but never leads to a fatal result. The same organism may kill small birds. Roux and Yersin were able to increase the virulence of an organism which produced a local oedema in guinea-pigs by mixing it with a streptococcus. The virulence is therefore not a fixed quantity.

C. Objection to the identity of the two bacilli may be taken on the ground that a totally non-virulent pseudo-diphtheria bacillus has so far never been made virulent. The objection, however, cannot be upheld in view of an experiment of Roux and Yersin: virulent bacilli were isolated from the throat of a person suffering from diphtheria; as the patient progressed to convalescence, the bacilli became less virulent and were finally totally avirulent and their virulence could not be restored.

Martin has proved that some short bacilli which are not fatal to guinea-pigs are degenerated diphtheria bacilli.

Martin's experiment.—An eight months old broth culture of a long, very virulent bacillus was subcultivated in broth; the organism failed to grow, but when sown on agar covered with a film of recently prepared veal broth gave a growth of a short bacillus which remained short in subsequent subcultivations. On inoculation, it did not kill guinea-pigs but gave rise to a local oedema from which the short bacillus was recovered.

This artificially obtained short bacillus was pathogenic for sparrows, and on inoculating a normal sparrow and a sparrow which had been treated with anti-diphtheria serum each with 0.1 c.c. of a broth culture of the organism, the normal sparrow died while the other survived. This short bacillus, non-virulent for guinea-pigs, was therefore undoubtedly a diphtheria bacillus.

D.—In suitable culture media, non-virulent diphtheria bacilli frequently produce toxin neutralizable by antidiphtheria serum (Martin).

[In this case apparently a non-virulent diphtheria bacillus was under observation. Such bacilli admittedly exist. See p. 255.]

E.—According to Spronck, a prophylactic inoculation of antidiphtheria serum prevents the development of a local oedema when a diphtheria bacillus is inoculated but not when a pseudo-diphtheria bacillus is inoculated. This however does not appear to be a constant phenomenon.

CHAPTER XVI.

BACILLUS PYOCYANEUS.

Introduction.

Section I.—Experimental inoculation, p. 276.

Section II.—Morphology, p. 277.

1. Microscopical appearance and staining reactions, p. 277. 2. Cultural characteristics, p. 278.

Section III.—Biological properties, p. 279.

1. Pigments, p. 279. 2. Toxins, p. 280. 3. Vaccination and serum therapy, p. 280. 4. Agglutination, p. 281. 5. Antagonism, p. 281.

Section IV.—Detection and isolation of the organism, p. 281.

THE cause of blue suppuration was discovered by Gessard.

Blue pus is rarely seen nowadays though it was very common before the introduction of antiseptics. The *bacillus pyocyaneus* is always associated in these conditions with the ordinary micro-organisms of suppuration; its presence in a wound is simply a complication and that not of a serious nature.

The *bacillus pyocyaneus* may invade the tissues of the body when the resistance of the latter has been broken down by some pre-existing pathological condition. It has, for instance, often been found in the internal organs in cases of enteric fever; Calmette found it in the blood of persons suffering from chronic dysentery [and Williams and Lartigan in association with diarrhoea]. [Of twenty-three cases of pyocyaneus infection occurring in British Guiana and recorded by Minett and Duncan six were cases of acute filariasis and six others showed intestinal ulceration.] On the other hand it may be the primary cause of disease: e.g. of enteritis (Legros), appendicitis (Coyne and Hobbs), otitis, pseudo-membranous sore throat (Calvo Ignacig), etc.: some twenty cases of a generalized infection with the *bacillus pyocyaneus* have moreover been recorded.

[Dogs are liable to infection with the *bacillus pyocyaneus* and in these animals the symptoms may clinically resemble rabies; and moreover the inoculation of brain tissue from the affected animals into normal rabbits and guinea-pigs produces symptoms similar to those seen in the original animal.]

The organism is sometimes found in the soil, in dust and in water. Besson has recorded its almost constant presence in the waters of the regency of Tunis where blue suppuration is very common and where serious infections are often complicated by the *bacillus pyocyaneus*.

SECTION I.—EXPERIMENTAL INOCULATION.

The *bacillus pyocyaneus* is pathogenic to rabbits, guinea-pigs, rats and mice.

Rabbits.—Sub-cutaneous inoculation in rabbits is rarely fatal: intra-peritoneal inoculation does not give constant results.

The injection of 1 c.c. of a broth culture into the ear vein of a rabbit, which is the most certain method of producing infection, causes an acute disease. The animal suffers from fever, albuminuria and diarrhoea and dies in 24–48 hours. The organisms are very numerous in the liver, spleen and kidneys but only a few are to be found in the blood.

Inoculation of smaller doses of culture leads to a chronic but not necessarily fatal disease in the rabbit which is characterized by wasting, paralysis of the limbs and convulsions. If death take place it is not uncommon to find *post mortem* a true nephritis with small contracted kidney, and even hypertrophy of the left ventricle of the heart. In some cases there is amyloid degeneration of the kidneys and infarcts may be present in the alimentary mucosa (Charrin).

By feeding rabbits with the organism Brau produced fatty degeneration of the liver and ulceration of the intestine followed by generalization of the bacillus in the tissues of the animal.

Guinea-pigs.—In guinea-pigs, sub-cutaneous inoculation produces a local swelling followed by ulceration: the organism then becomes disseminated and the animal dies. Intra-peritoneal inoculation is more severe and death takes place rapidly; the bacillus is found in the blood.

Rats. Mice.—The results are the same as in the guinea-pig: mice are very susceptible.

An organism isolated by Besson from the water of Zaghouan killed white rats in 20–36 hours when inoculated sub-cutaneously in doses of 0.20 c.c. *Post mortem* the abdominal organs were congested, the peritoneum contained a small quantity of an almost clear fluid and the intestines showed an early stage of ulceration in many of the Peyer's patches: in two cases the animals had hæmaturia and the organism was found in the blood, liver, kidneys, peritoneal fluid, intestinal contents, and in the urine in the bladder.

Increase of virulence.—The virulence of the *bacillus pyocyaneus* can be increased by passage through rabbits to such an extent that after a few passages a dose of 0.1 c.c. of a broth culture rapidly kills animals of this species.

SECTION II.—MORPHOLOGY.

1. Microscopical appearance.

The *bacillus pyocyaneus* is a small motile rod-shaped [non-spore bearing] organism with rounded ends, and of variable size. Its average length is about 1.5μ and its breadth 0.5 to 0.6μ . It has one flagellum situated terminally [monotrichous].

Staining reactions.—The *bacillus pyocyaneus* is easily stained by the basic aniline dyes and is gram-positive.

The bacillus stains rather badly by Gram's method: some strains stain feebly and irregularly, and decolourization takes place easily if the action of the alcohol be prolonged.

Morphological variations.—The morphology of the *bacillus pyocyaneus* undergoes considerable change if sown in media containing small amounts of antiseptics (Guignard and Charrin). For instance, in broth containing 0.02 per cent. of carbolic acid the organism is long and filamentous. The addition of alcohol and bichromate of potassium to the medium have a



FIG. 173.—*Bacillus pyocyaneus*. Film from an agar culture (dilute carbol-fuchsin). (Oc. III, obj. $\frac{1}{4}$ th, Reich.)

similar effect. In broth containing boric acid the bacillus assumes a spiral form, and in media containing creosote it looks like a coccus (figs. 174 to 177).



FIG. 174.—Culture in 4 per cent. alcohol broth.



FIG. 175.—Culture in 0.015 per cent. potassium bichromate broth.

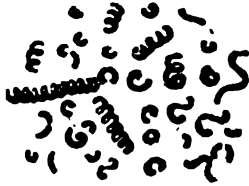

FIG. 176.—Culture in 0.70 per cent. boric acid broth.



FIG. 177.—Culture in 0.10 per cent. creosote broth.

FIGS. 174-177.—Different morphological appearances presented by the *Bacillus pyocyaneus* when grown in broth containing traces of antiseptics (after Guignard and Charrin).

2. Cultural characteristics.

Conditions of growth.—The *bacillus pyocyaneus* is a facultative aërobie but the pigment is only formed in presence of air. It grows at all temperatures between 15° and 43° C., the optimum temperature being about 35°-37° C.



FIG. 178.—*Bacillus pyocyaneus*—broth culture—1st day.

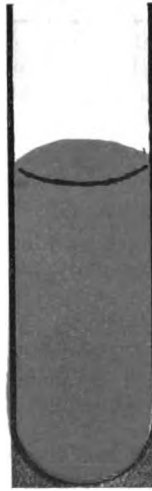

FIG. 179.—*Bacillus pyocyaneus*—broth culture—3rd day.



FIG. 180.—*Bacillus pyocyaneus*—broth culture—7th day.

Characters of growth on various media. (i) **Broth.**—After incubating at 37° C. for 8 hours the medium becomes cloudy, and then a greenish fluorescence appears at first limited to the upper part of the medium then

extending throughout. During the next few days a white wrinkled pellicle forms on the surface, which as growth proceeds becomes thicker, dry and brown and falls to the bottom of the tube where it forms a dirty white deposit, the broth at the same time becoming deep green in colour and afterwards brownish. The culture is viscous and ropy and has a peculiar odour.

(ii) **Gelatin.** *Stab culture.*—After incubating for 2 days at 20° C. small colonies appear along the line of the stab: these coalesce and form a white streak: liquefaction commences about the third day (champagne glass liquefaction) and rapidly extends to the walls of the tube. The medium is coloured green.

Isolated colonies.—Small, yellowish, granular colonies appear on the plates after incubating for 2 days. Liquefaction occurs round them and gradually extends throughout the plate. The gelatin assumes a green tint.

(iii) **Agar.**—After incubating for 24 hours at 37° C. a greenish streak appears on the agar which rapidly spreads over the surface, the agar taking a fluorescent green colour.

(iv) **Potato.**—Along the line of sowing a thick brown layer is formed, and if this be removed the surface of the potato beneath becomes green on exposure to air.



FIG. 181.—Surface culture on agar—8 days at 37° C.

SECTION III.—BIOLOGICAL PROPERTIES.

1. Pigments (Gessard).

When a broth culture of the *bacillus pyocyaneus* is shaken up with a little chloroform and allowed to stand for a moment the chloroform separates at the bottom of the tube and is coloured pure blue, while a beautiful fluorescent green watery liquid floats to the surface.

The *bacillus pyocyaneus* secretes three pigments, one blue (*pyocyanine*); another fluorescent and green and identical with the pigment produced by saprophytic fluorescent bacilli; the third is greenish and non-fluorescent and of little importance.

In contact with air pyocyanine oxydizes and forms a brown substance, *pyocyanthosé*.

Pyocyanine is easily obtained by extracting a broth or agar culture with chloroform. In the case of agar it is only necessary to leave the chloroform on the culture for a few hours without shaking. The chloroform acquires a blue colour, and if evaporated long blue needles of pyocyanine crystallize out. Solutions of pyocyanine are turned red by dilute acids but the blue colour is restored on the addition of an alkali. Cultures in broth or peptone solution retain their colour after filtration through a Chamberland bougie. Pyocyanine is not toxic.

The formation of pyocyanine and of the green pigment may be varied at will and even suppressed by growing the organism on different culture media.

In a solution of peptone, Gessard was able to suppress the formation of the green pigment and the culture then had a very pretty blue colour (this phenomenon cannot be obtained with all peptones). In the same way, on glycerin-peptone-agar (the test medium of Gessard) the amount of pyocyanine produced is considerably increased. Pyocyanine is the only pigment formed when the organism is sown in a 10 per cent. gelatin medium containing a little glycerin and incubated at 35° C.

On the other hand, the green pigment is formed to the exclusion of the others when

a medium containing 2 per cent. glucose is used, and the same result is obtained with white of egg.

No pigment at all is formed in broth containing 5-6 per cent. of glucose, or when the bacillus is grown on the serum of immunized animals.

Gessard was successful in producing strains of the bacillus some of which secreted the green pigment, and others pyocyanine. Wasserzug grew the bacillus on slightly acid media and found that it had altogether lost its power of pigment production. Charrin obtained a similar result by sub-culturing in broth and incubating the cultures at 42° C.

Melanogenic variety.—Cassin and Gessard studied a strain of the *bacillus pyocyanus* which when sown in broth produced in the first instance the ordinary pigment but later a dark brown and finally a black pigment. Cultures on potato formed a deep brown layer which soon turned black. This production of black pigment was found to be possible only when tyrosin was present in the media. In a "mineral" medium such as the following:—

| | |
|--|------------|
| Ammonium succinate, - - - - - | 1 gram |
| Sodium phosphate, - - - - - | 1 " |
| Magnesium sulphate, - - - - - | 2.5 grama. |
| Calcium chloride (crystals), - - - - - | 1.25 " |
| Water, - - - - - | 1000 " |

this bacillus produces no black pigment, the growth having all the characteristics of an ordinary *bacillus pyocyanus*; but by adding 0.5 per cent. of tyrosin to the medium a rose colour is at first produced which later becomes a deep brown.

2. Toxins.

Filtered cultures of the *bacillus pyocyanus* inoculated in sufficient quantity into rabbits either cause death with all the symptoms of the acute experimental disease or lead to cachexia and paralysis which may also terminate fatally.

Wassermann obtained a very toxic product by incubating broth cultures for 40 days and then sterilizing them by leaving them to stand under toluol for a week. These cultures killed guinea-pigs in doses of 0.5 c.c. when inoculated intra-peritoneally.

The toxicity of the cultures is not due to pyocyanine but to certain other substances, some of which are volatile, easily destroyed and have merely a transitory action, while others are non-volatile. The non-volatile products may be divided into two groups; those of the first group—the most toxic—are precipitated by alcohol, the others are soluble in alcohol (Arnaud and Charrin).

If injected into the veins of a rabbit the products of the *bacillus pyocyanus* rapidly lead to the death of the animal without an incubation period. This absence of an incubation period is to be referred chiefly to the action of the volatile constituents which are not a part of the true toxins.

Pyocyanolysin.—Cultures in neutral peptone-broth, 7-30 days old, filtered or killed by toluol or heat (15 minutes at 60° C.), have a powerful hæmolytic action on freshly defibrinated ox, sheep and rabbit blood (Bullock and Hunter).

Cultures 3-4 weeks old are the best for demonstrating these properties. The cultures are strongly alkaline in reaction.

Pyocyanolysin withstands high temperatures. The hæmolytic property is not destroyed by heating cultures at 100° C. for 15 minutes, and it is also said to be unchanged by heating at 120° C. for 30 minutes (Weingeroff, and Breymann).

3. Vaccination—Serum therapy.

If an average dose of a culture be inoculated beneath the skin of a rabbit the animal suffers no harm. Rabbits can be immunized by inoculating them

in this manner with doses of 0·5–1 c.c. of a broth culture on five or six occasions at intervals of 3 or 4 days: or by inoculating them with small doses of filtered cultures or cultures heated at 115° C.

The blood and urine of animals treated with filtered cultures will also immunize animals.

Wassermann immunized guinea-pigs by inoculating them in the peritoneal cavity with gradually increasing doses of living culture or toxin. Guinea-pigs vaccinated with living cultures show a permanent immunity to the organism, but an inoculation of toxin is fatal to them. Their serum is prophylactic and has feeble therapeutic properties, but is not antitoxic. Guinea-pigs vaccinated with toxin are immune against both the organism and the toxin, and their serum is prophylactic, distinctly therapeutic and antitoxic.

The *Bacillus pyocyaneus* will grow in the serum obtained from immunized animals: it preserves its shape, its vitality and its virulence, but forms *agglutinated colonies* (Charrin and Roger, Gheorghiewsky) and produces no pigment. The serum of immunized animals is therefore not bactericidal; it is simply *agglutinating in vitro*. The agglutinating property does not run parallel with the prophylactic property.

4. Agglutination.

The agglutinating property of the blood of vaccinated animals has just been referred to. The blood of infected persons when diluted 1 in 40 to 1 in 100 similarly agglutinates the bacillus, and normal human serum has in some cases an agglutinating action in a dilution of 1 in 10. To demonstrate the agglutination it is best to add the serum to an emulsion prepared by diluting in normal saline solution the centrifuged deposit of broth cultures at least 24 hours old.

5. Antagonism.

The *Bacillus pyocyaneus* impedes the growth of anthrax in cultures. In the same way by inoculating a mixture of the anthrax bacillus and the *Bacillus pyocyaneus* into animals susceptible to anthrax the animals do not become infected with anthrax. Porcelain-filtered cultures of the *Bacillus pyocyaneus* possess the same properties (Blagovetschensky).

Similarly the *Bacillus pyocyaneus* will prevent the development of the cholera vibrio (Kitasato).

Rumpf has recorded a parallel antagonism between the *Bacillus pyocyaneus* and the typhoid bacillus; he successfully treated 65 cases of enteric fever by inoculating the patients with sterilized cultures of the *Bacillus pyocyaneus*. It does not appear that much faith should be put in these statements. Analogous investigations undertaken on the guinea-pig by Besson led him to the conclusion that these animals when treated with filtered cultures of the *Bacillus pyocyaneus* are more than normally susceptible to the action of the typhoid and colon bacilli: moreover, infection with the *Bacillus pyocyaneus* has been recorded coincidentally with a fatal attack of enteric fever in man.

SECTION IV.—DETECTION, ISOLATION AND IDENTIFICATION OF THE BACILLUS PYOCYANEUS.

The presence of the *Bacillus pyocyaneus* in pus is detected by the blue colour of the dressings and by the characteristic smell of the wound.

Pus should be examined by staining films with gentian-violet or thionin. The bacilli can be easily isolated on gelatin plates on which they produce a characteristic appearance. At the *post mortem* examination cultures should

also be sown in broth with blood and scrapings of tissues. The characteristic colour produced by the bacillus is sometimes only apparent after several sub-cultures in broth or on agar.

Inoculations should be made into the peritoneal cavity of a guinea-pig or into the ear vein of a rabbit.

Besson isolated the organism from water by sowing in Metchnikoff's gelatin-peptone-salt medium (p. 33). When growth appeared after 12-15 hours a sub-culture was made in the same medium, and a trace of this second culture was sown on gelatin plates from which the organism was easily obtained in pure culture.

CHAPTER XVII.

THE BACILLUS OF SWINE ERYSIPELAS.¹

Introduction.

Section I.—Experimental inoculation, p. 284.

Section II.—Morphology and cultural characteristics, p. 284.

Section III.—Biological properties, p. 286.

Section IV.—The detection, isolation and identification of the bacillus, p. 287.

The bacillus of mouse septicæmia (*Bacterium murisepticum*), p. 288.

SWINE erysipelas (measles) is due to a bacillus discovered by Pasteur and Thuillier, and of which the classical description was given by Lœffler.

A very large number of deaths among swine are attributable to swine erysipelas and the disease becomes therefore of considerable economic importance. The acute form of the disease is nearly always fatal, and in infected herds about 50 per cent. of the animals die.

Swine are liable to the disease between the ages of 6 months and 2 years; under 3 months old they are immune and beasts more than 2 years old are rarely infected.

Highly bred swine, such as the English breeds, are the most susceptible, while wild animals are immune.

Swine become infected by feeding upon the excreta of infected animals; they are almost the only animals susceptible to the spontaneous disease; pigeons, [mice], and rabbits which have frequented infected pig-sties are however sometimes attacked.

The flesh of suspected animals, and even of those dead of the disease, is frequently consumed as food without apparently causing any harmful effects in man: but cases of painful erythema have been noticed following the accidental inoculation of the virus.

Swine erysipelas occurs in two forms, acute and chronic.

The **acute** form of the disease is characterized by the appearance of bright or dark red purpuric spots on the skin, chiefly about the ears, the anus and vulva, the internal surface of the thighs and the groins. The animal suffers from diarrhœa: it grunts dismally and remains lying down hidden in its bedding with its tail uncurled and hanging down: its temperature is raised and death takes place in from 48–72 hours.

Chronic swine erysipelas is the less severe form of the disease; recovery after an attack is not infrequent, though some animals never recover completely. When an animal begins to recover, desquamation occurs about the spots on the skin. The characteristic swelling of the joints is responsible for a peculiar gait noticed in infected animals, and for the disease being sometimes called *Gout*.

Post mortem, in swine dead of the disease, there is frequently in addition to the spots on the skin an intense congestion of the serous membranes and of the intestines; the lymphatic glands especially those of the abdomen are swollen and congested; the spleen is very much enlarged and diffluent and shows bosses on the surface;

¹[(Fr. Rouget du porc, érysipèle, rougeole. Ger. Schwein Rothlauf.)]

the liver is congested and the blood very dark in colour. More rarely, a thickening of the walls of the intestine and patches of broncho-pneumonia are present.

The specific organism is found in the liquid discharges from the bowel, in the spleen, lymphatic glands, bone marrow, and also but in smaller numbers in the blood, liver and kidneys.

The bacillus of swine erysipelas appears to be frequently present as a saprophyte in the tonsils and intestinal canal of healthy pigs (Olt, Pitt, Overbeck). Pitt found the organism in the intestine in 26 out of 66 and in the tonsil in 28 out of 50 normal animals examined by him.

SECTION I.—EXPERIMENTAL INOCULATION.

1. Animals susceptible to the disease.

Swine, pigeons, mice and rabbits are all susceptible to swine erysipelas but in different degrees. Guinea-pigs are immune.

Inoculation into the pectoral muscle of a pigeon or into the sub-cutaneous tissue of a mouse is fatal in 3 or 4 days. Rabbits are more resistant and to produce a fatal result the virus must be inoculated into a vein.

When passed through a series of rabbits the virulence of the virus is increased for rabbits but diminished for swine. The first rabbit is inoculated intra-venously with a culture from a pig and the spleen of the first rabbit is used for inoculation of the second and so on.

On the other hand, the virulence is increased for all susceptible animals by passage through pigeons.

It is a curious fact that swine are not very susceptible to experimental infection, and even when the virus is inoculated into a vein it seldom leads to a fatal result; so that to produce the disease in these animals a virus experimentally increased in virulence must be used for inoculation. It is however possible to infect *pure bred* swine by feeding them on the organs of animals which have died of the disease.

2. Technique of inoculations.

The general rules applicable to the inoculation of animals must be observed and special attention given to the following points. The material for inoculation may be taken directly from the spleen, lymphatic glands or blood of an animal dead of the disease, though it is better to sow a broth culture with a fragment of the spleen and to inoculate a little of the culture after incubating it for 36–48 hours.

3. Symptoms and lesions.

The *symptoms* have already been detailed.

The most prominent lesion in experimentally-infected animals is the swelling and softening of the spleen. The organism will be most easily detected in the spleen, bone marrow, tonsils, lymphatic glands and blood, but may also be found in the liver and kidneys. Sections of the lymphatic glands, spleen, liver and kidneys should also be cut.

SECTION II.—MORPHOLOGY.

1. Microscopical appearance.

The micro-organism of swine erysipelas is a small, non-motile bacillus, visible only with difficulty in unstained preparations, and measuring 0·5–1·5 μ by 0·2–0·3 μ . In the blood and internal organs it occurs singly, in pairs or

in groups. In broth cultures it forms short chains (fig. 182). The bacilli are more numerous in the spleen and lymphatic glands than in the blood. They are frequently found within the leucocytes, and in sections masses of bacilli will be seen within the capillaries.

The bacillus is not known to form spores.

Staining methods.—The bacillus of swine erysipelas stains readily with



FIG. 182.—Bacillus of swine erysipelas (broth culture). Carbol-thionin. (Oc. iv, obj. $\frac{1}{4}$ th, Reichert.)



FIG. 183.—Bacillus of swine erysipelas in pigeon's blood—Gram's stain. (Oc. iii, obj. $\frac{1}{4}$ th, Reichert.)

the basic aniline dyes, is gram-positive, and retains the violet in Claudius' method. The best methods to use are :

- (a) Cultures.—Stain with carbol-thionin or dilute carbol-fuchsin.
- (b) Blood-films and smears of tissues.—Carbol-thionin or carbol-methylene-blue may be used, but Gram's method is preferable.
- (c) Sections.—Gram's method should be used with either double or triple staining (p. 219).

2. Cultural characteristics.

Conditions of growth.—The bacillus of swine erysipelas is indifferently aërobie. Growth is better under anaërobie conditions but is always rather scanty.

Cultures, which should be sown with the blood, pulp of organs, or bone marrow of an animal recently dead of the disease, are easily obtained at temperatures between 15° and 40° C. on the ordinary media.

Broth.—The medium soon becomes slightly opalescent when incubated at 33°–38° C. The growth which is always scanty ceases about the fourth day, and subsequently forms a very small white precipitate.

Gelatin. Stab culture.—The growth in gelatin stab-culture is characteristic. Along the stab a thin opaque line develops, from which numerous small very delicate branching filaments radiate. The growth is more luxuriant in the depth of the stab. Towards the twentieth day, the characteristic appearance vanishes and the culture becomes cloudy. There is never any liquefaction of the gelatin (fig. 184).

Stroke culture.—Cultures on the surface of a sloped gelatin tube radiate from the line of sowing like the feathers of a quill.

Single colonies.—Fine downy flocculi giving off delicate radiating filaments are seen embedded in the gelatin, then the appearance becomes



FIG. 184.—Bacillus of swine erysipelas. Stab culture in gelatin (8 days).

woolly-looking and the centre of the colony forms a small brownish spot.

Agar.—At first the growth is similar to that on gelatin, but it soon assumes an homogeneous appearance and forms a delicate scanty layer.

Potato.—On potato the organism only grows under anaërobic conditions and then forms a barely visible streak.

SECTION III.—BIOLOGICAL PROPERTIES.

1. Vitality and virulence.

FIG. 185.—Bacillus of swine erysipelas. Single colony on gelatin $\times 60$ (8 days).

The bacillus of swine erysipelas remains alive for several months in cultures under anaërobic conditions, and shows an equal vitality in deep stab cultures in ordinary gelatin: it will give rise to sub-cultures and even kill pigeons after 6 months.

In aërobic broth cultures kept in the warm (37° – 39° C.) incubator the virulence as well as the vitality vanish much more rapidly. The virulence becomes progressively enfeebled and after about 20 days the culture is harmless. As already pointed out the virulence of an attenuated virus can be restored by passage through pigeons.

2. Vaccination.

One attack of the acute disease confers immunity on swine; moreover an attack of the chronic form (*Gout*) protects an animal from the acute disease. Pasteur and Thuillier considered it possible to immunize animals by inoculating them with attenuated viruses, and at the present time vaccination of swine is very extensively practised, especially in Austria.

For the purposes of vaccination broth cultures which have been attenuated (through the action of the oxygen of the air) by incubation for a longer or shorter time in the warm incubator may be utilized.

The pigs are inoculated first with a very weak virus, and then with a virus which has not been in the incubator so long and which is therefore somewhat more virulent. Pigs should be inoculated before they are 4 months old as they are then less susceptible to the disease. The immunity so conferred, which is complete 12 days after the second inoculation, lasts about a year, and this is a sufficient length of time for fattening purposes. If the animal is to be kept for breeding it is well to repeat the vaccination at the end of a year.

As stated above, the organism may also be attenuated for the pig by passage through rabbits. After several passages the virus becomes very virulent for rabbits, but attenuated for swine, and may then be used for inoculation as a vaccine. For this purpose a tube of broth is sown with the spleen of the last rabbit of the series and incubated, and the pig is vaccinated with the culture.

3. Soluble products. Serum therapy.

(i) Negative results follow the injection of filtered cultures. The amount of growth, as has already been pointed out, always remains very scanty and toxins are not formed in any appreciable quantity. But if rabbits be inoculated sub-cutaneously with small quantities of unfiltered cultures they quickly recover, and it soon becomes possible to inoculate large doses into the veins without producing any morbid symptoms. Emmerich, Leclainche and others killed rabbits which had been treated in this manner, made an

emulsion by pounding and extracting the muscles and organs, and obtained a product which after filtration possessed both vaccinating and therapeutic properties.

(ii) Lorenz prepares a serum which has distinct therapeutic properties. A rabbit is inoculated sub-cutaneously first of all with a few cubic centimetres of specific serum (1 c.c. per 1 kg. of body weight); two days later, and again on the twelfth day, the rabbit is inoculated (sub-cutaneously) with a virulent culture, the second and third doses being larger than the first. After a further interval of 10 days a large dose of culture is administered intra-venously.

(iii) Mesnil, adopting Pasteur's method of attenuated viruses, immunizes rabbits as follows: At intervals of 1 week a rabbit receives, first, 0.25 c.c., then 1 c.c. of a very attenuated virus—the first vaccine. This is followed by inoculations of a less attenuated virus—the second vaccine—in doses of 0.25 c.c. first and 1 c.c. later. Finally, at periods varying from a week to a month increasing doses of virulent culture—0.25 c.c., 1 c.c., 3 c.c., 4 c.c., 5 c.c., 10 c.c.—are used. Immunization requires about 6 months' treatment, and in spite of the small doses used some of the animals die. It is only after about 3 months that the animals under experiment can resist the inoculation of a large dose of culture every week or 10 days without showing considerable reaction. The serum of animals prepared in this way if given in doses of 0.05 c.c. protects mice against an inoculation of a virulent virus given the following day. In doses of 0.25 c.c. it exhibits therapeutic properties provided it be administered within 24 hours of infection. The serum is also efficient in the case of pigeons and rabbits. It is not bactericidal, for if the bacillus be sown in the serum it grows in long chains and moreover retains its virulence.

(iv) Leclainche uses horses for the preparation of his prophylactic serum: 200 c.c. of a virulent culture (one which will kill pigeons in doses of 0.25 c.c. when inoculated into the pectoral muscle) are inoculated into the jugular vein and the inoculations repeated at intervals of about 10 days. The resulting serum is prophylactic for rabbits in doses of 0.5–1 c.c. and the immunity conferred lasts 1 or 2 days. Inoculation of 1 c.c. of this serum mixed with an equal volume of a virulent culture confers a lasting immunity (*Sero-vaccination*).

Leclainche has applied this method to the vaccination of swine. He inoculates healthy pigs on the inner side of the thigh first with a mixture of 5–10 c.c. of serum and one-half a virulent culture, and 12 days later with one-half a virulent culture without serum. If he has to deal with an herd already infected he inoculates them with 10–20 c.c. of serum without any culture 2 days before he inoculates the first vaccine.

The serum has no appreciable therapeutic property.

4. Agglutination.

The serums prepared by Mesnil's and by Leclainche's methods agglutinate the bacillus of swine erysipelas to a marked degree. The serums of infected rabbits and pigeons show no agglutinating properties (Overbeck).

SECTION IV.—THE DETECTION, ISOLATION AND IDENTIFICATION OF THE ORGANISM.

The recognition of the disease is of supreme importance from the point of view of vaccination, and the demonstration of the organism is of great

help in diagnosis and in differentiating the disease from *hog cholera* [*swine fever*].

The following observations and experiments should be made :

1. Stain blood films and smear preparations of the lymphatic glands, spleen and bone marrow by Gram's method, etc. and examine them for the bacillus (*vide* "Microscopical appearance").

2. Sow cultures from the spleen in broth and on gelatin.

3. Inoculate pigeons and guinea-pigs with broth cultures.

Guinea-pigs it will be remembered are immune to swine erysipelas, but they are very susceptible to *hog cholera* [or swine fever]. This experiment therefore will differentiate between the two diseases.

The bacillus of mouse septicæmia (Koch).

(*Bacterium murisepticum*.)

The septicæmic disease of the domestic mouse (*Mus musculus*), investigated by Koch, is due to a small bacillus, similar to that of swine erysipelas, but on inoculation somewhat less rapidly fatal than the latter organism. It is not pathogenic for the field mouse (*Arvicola arvalis*) nor for pigeons nor rabbits. But if its virulence be increased by numerous passages through mice a virus is ultimately obtained which, on intra-venous inoculation, proves fatal to pigeons.

The symptoms observed in experimentally-infected mice are drowsiness, blepharitis and a spasmodic form of respiration. The disease finally terminates fatally. Bacilli are to be found in large numbers in the blood and in the internal organs.

The morphological characteristics and staining reactions of this organism are the same as those of the bacillus of swine erysipelas. The cultures of the two organisms are very much alike ; there is, however, this difference that the growth of the *bacterium murisepticum* in gelatin is more cloudy and the radiating filaments are not so well marked.

The serums of animals immunized against the bacillus of swine erysipelas agglutinate the bacillus of mouse septicæmia (Overbeck). This affords definite proof that the latter bacillus is not a distinct species [but merely a variety of the bacillus of swine erysipelas adapted to its special host.]

CHAPTER XVIII.

BACILLUS TUBERCULOSIS.

Introduction.

1. Types of tubercle bacilli, p. 289. 2. Human tuberculosis, p. 292. 3. Tuberculosis in the lower animals, p. 294. 4. Associated micro-organisms, p. 297.

Section I.—Experimental inoculation, p. 297.

Section II.—Morphology, p. 305.

1. Microscopical appearance, p. 305. Staining methods, p. 306. The staining of films, p. 307. The staining of sections, p. 310. Appearance of stained bacilli, p. 312. 2. Cultural characteristics, p. 314.

Section III.—Biological properties, p. 322.

1. Viability and virulence, p. 322. The action of antiseptics, p. 323. 2. Toxins, p. 323. The toxic properties of dead bacilli, p. 323. Koch's old tuberculin, p. 324. Tuberculin T.A., T.O., T.R., p. 328. Maragliano's tuberculin p. 329. Toxalbumin, p. 329. 3. Vaccination, p. 330. 4. Serum therapy, p. 334. 5. Agglutination, p. 335. 6. Immune body, p. 337.

Section IV.—The detection of the tubercle bacillus, p. 337.

A. Sputum, p. 339. B. Blood, p. 341. C. Pus, p. 342. D. Exudates, p. 342. E. Granulomata, p. 343. F. Nasal cavities, p. 343. G. Urine, p. 343. H. Excreta, p. 344. I. Milk, p. 345.

The paratubercle or acid-fast bacilli, p. 345.

The smegma bacillus, p. 346. The bacillus of verruga peruana, p. 346. Pseudo-tuberculoses, p. 347.

THE tubercle bacillus, discovered by Koch, is the cause of tuberculosis in man and the lower animals.

In accordance with established practice, the infecting agent in tuberculosis will, in the present chapter and elsewhere in this book, be spoken of as a bacillus although it is now agreed that it should be classed with the genus *Discomyces* (*Streptothrix* of Cohn). Metchnikoff has suggested for it the name *Sclerothrix kochi*.

1. Types of tubercle bacilli.

Of the tubercle bacilli recoverable from human tissues and from the tissues of the lower animals four types can be distinguished, differing from one another in various characteristics. It is customary therefore to speak of human, bovine, avian and ichthic tubercle bacilli, meaning thereby the type of bacillus [most commonly] obtained from human, bovine, avian or ichthic sources respectively.

(a) **The human and the bovine types of tubercle bacilli.**—Most bacteriologists, Koch's opinion notwithstanding, are agreed in regarding the human and the bovine types of tubercle bacilli as identical, for [in the opinion of these observers] the facts which can be brought in support of this view are numerous and conclusive. Each bacillus though best adapted to the particular species

of animal—man and bovine respectively—in which it finds its normal habitat may nevertheless infect either of them, and though the bovine bacillus appears to be more virulent than the human bacillus the latter, according to de Jong, may by passage through goats be made as virulent for bovine animals as the bovine bacillus itself.

[The findings of the English Commission¹ are not altogether in agreement with the statements contained in the preceding paragraph.

[In the opinion of this Commission the human and bovine types are not identical but “varieties of the same bacillus.” They point out that since the human and the bovine tubercle bacilli are “morphologically indistinguishable” the question of their identity or non-identity resolves itself into a consideration of their cultural and pathogenic differences or similarities.

[With regard to the former, the human type consistently grows more luxuriantly in culture than the bovine type and this difference in cultural characteristics is quite definite though “the gap which separates the human type from those strains of the bovine type which grow most abundantly is not wide.”

[A study of their pathogenic resemblances and differences shows on the one hand that the disease produced in certain species of animals such as guinea-pigs and monkeys by the two types is “histologically and anatomically identical” and on the other hand that in man fatal tuberculosis due to infection with bacilli of the bovine type is identical with that caused by the human type.

[That the bovine bacillus can infect man is certain. Many cases of tuberculosis in children and a few in adults investigated by Cobbett and A. S. Griffith (working for the English Commission) were shown to be caused solely by the bovine tubercle bacillus. An infection of the bovine species by the human tubercle bacillus on the other hand did not occur: the human tubercle bacillus was in fact incapable of producing in cattle anything but a slight and non-progressive tuberculosis, however large the dose.

[Neither did the human type of bacillus cause anything more than a slight non-progressive tuberculosis in goats, pigs and, with rare exceptions, in rabbits, while the bovine bacillus readily caused a fatal tuberculosis in these animals as well as in cattle.

[Certain tubercle bacilli isolated during the investigations of the Commission from cases of lupus and equine tuberculosis had the cultural characteristics of the bovine bacillus but were only slightly virulent for calves and rabbits (the animals usually relied on for differential tests) and were of relatively low virulence also for monkeys and guinea-pigs. These bacilli, it would seem, in no way bridge the gap between the two types; for while they approach the human tubercle bacillus in their low degree of virulence for calves and rabbits, they recede from it in virulence for monkeys and guinea-pigs (A. S. Griffith). At the same time, as the Commissioners point out, “the discovery of these exceptional bacilli makes it impossible to regard differences of virulence for the calf and rabbit as sufficient to establish the non-identity of the human and bovine types.” Several of these attenuated bacilli isolated from human (lupus) and equine sources were raised to the full virulence of a typical bovine bacillus by passage through calves and rabbits.

[To establish the complete identity of the two types it would appear to be necessary to demonstrate that both cultural and pathogenic differences were unstable, *i.e.* that the transmutation of the human type of bacillus into the

[¹ The references to the “English Commission” in this chapter are to the Reports and Appendices thereto of the Royal Commission on Tuberculosis appointed in 1901.]

bovine or *vice versa* was possible, and on this point after reviewing the numerous prolonged passage experiments on various species of animals carried out under their direction the Commissioners conclude that "transmutation of bacillary type" is "exceedingly difficult if not impracticable of accomplishment by laboratory procedure."

[Though it has been considered desirable to introduce thus briefly the conclusions arrived at by the English Commission,] it is altogether beyond the scope of the present work to enter upon a discussion of the arguments which have been brought forward in support of their theses by those who hold that the human tubercle bacillus is identical with the bovine and by those who are of contrary opinion. For these arguments the reader is referred to the publications of the authors whose names are mentioned in the text and to those of other writers on the subject.

(b) **The avian tubercle bacillus.**—Straus and Gamaléia regard avian tuberculosis as due to a special organism which, though closely allied to the human bacillus, constitutes a separate species. The view long held by Arloing and others that the human and the avian bacillus are identical has been [held to be] proved by certain experiments of Nocard (*vide infra*). [It is largely on the results of these latter experiments that] the bacillus of avian tuberculosis has been regarded merely as a strain or race of the human tubercle bacillus.

Nocard [claims to have] converted a human tubercle bacillus into an avian tubercle bacillus by growing it for a long time in collodion sacs in the peritoneal cavities of fowls. Nocard filled a collodion sac (p. 175) with a thick emulsion of a glycerin-potato culture of a human bacillus. The sac, after remaining at least 4 months in the peritoneal cavity of a fowl, contained a thick mass of bacilli which, when sown on culture media, gave, at first, a scanty growth, and this on sub-culture became more luxuriant and had all the characteristics of a culture of the avian bacillus (a soft, greasy, fatty, easily dissociated and wrinkled layer of growth). These cultures were only slightly virulent for guinea-pigs but highly virulent for rabbits which succumbed to a generalized miliary tuberculosis on inoculation with bacilli from the first passage and when inoculated with bacilli from the second passage the animal died of a tuberculous septicæmia without apparent lesions exactly as though it had been inoculated with an avian bacillus. After three passages of 6-8 months in collodion sacs the human tubercle bacillus killed fowls with symptoms identical with those of the spontaneous disease.

[A. S. and F. Griffith (working for the English Commission) entirely failed to confirm the results obtained by Nocard. No modification of human or bovine tubercle bacilli into avian, or of avian tubercle bacilli into mammalian, was demonstrated.

["With ten mammalian viruses, eight of which were *bovine*, sixteen collodion capsule experiments on fowls and twenty on pigeons were performed, lasting 55-186 days. In certain of the cases cultures, which were obtained from the capsules on removal from the bird's peritoneal cavity, were placed, again in capsules, in the peritoneal cavities of other birds, the total duration of residence being in one series as much as 475 days. In 20 of these experiments cultures were obtained from the capsules and found to be unchanged in character. In the remaining 16 cases the bacilli in the capsules were apparently dead."

["Similar experiments were performed with *human* tubercle bacilli obtained from 12 different sources. These experiments lasted from 59 to 685 days." The results were similar to those obtained with mammalian tubercle bacilli.

["With cultures of five *avian* viruses 25 collodion capsule experiments were performed on guinea-pigs. The duration of residence in individual guinea-pigs ranged up to 253 days and the total periods during which the cultures were in the peritoneal cavities of series of guinea-pigs varied up to 424 days." In two instances the bacilli in the capsules were dead: "from all the other capsules cultures were obtained and the bacilli were found to be unchanged" in cultural characteristics and virulence.]

Lydia Rabinowitsch isolated thirty-four strains of tubercle bacilli from birds. Two of these, isolated from birds of prey, had all the characteristics of the human bacillus. Rabinowitsch concluded from this investigation that the human and

avian tubercle bacilli are merely two varieties of the same species adapted to different conditions.

(c) **The ichthic tubercle bacillus.**—The ichthic tubercle bacillus is more sharply differentiated from its congeners (*vide infra*) but some observers, notably Mceller, Sargo and Suess [report that they] have succeeded in converting an human into an ichthic tubercle bacillus.

It appears to be true that all tubercle bacilli have a common origin, and that acclimatization under parasitic conditions in different animals has led to the creation of the four different types.

2. Human tuberculosis.

Man becomes infected with tuberculosis either by way of the respiratory or digestive tracts, more rarely by the skin and genital passages.

The tubercle bacillus is found in all tuberculous lesions in the human subject.

[As to the ætiology of *human tuberculous phthisis* opinion is somewhat sharply divided. The original theory was that tuberculous phthisis is commonly caused by the inhalation of tubercle bacilli. This doctrine received the support of Koch, Cornet, Pflügge and others. Chauveau however put forward the view many years ago that phthisis was not uncommonly caused by bacilli which had been ingested and absorbed from the intestine, and in recent years this doctrine has been strongly advocated by Behring.]

Behring thinks that infection generally takes place through the alimentary canal and that pulmonary tuberculosis of adults is merely a later stage of an intestinal infection contracted in the early years of life. Calmette and Guérin confirm this opinion [in so far as it relates to the channel of infection in phthisis¹] and bring forward numerous experiments to show that pulmonary tuberculosis (not inoculated) is always a sequela of a primary intestinal infection of which in the adult no trace of the original lesions in the mesenteric glands or abdominal viscera can be detected. [Calmette bases his opinion upon experiments on goats and bovines and on the researches of his pupils, Van Steenberghe and Grysez, on experimental anthracosis. Ravenel also from his own observations is led to believe that infection of the tonsils is the most frequent cause of apical tuberculosis but that infection may take place from any part of the alimentary canal and that the bacilli may pass through the wall of the intestine without leaving any indication of the site of infection in the form of a local lesion.]

[The view that phthisis is commonly caused by the inhalation of tubercle bacilli is, however, supported by many recent investigations. Cobbett, for instance, believes "that phthisis is commonly caused by the inhalation of tubercle bacilli" and from the results of an elaborate series of experiments devised to ascertain the ætiology of pulmonary tuberculosis in which he repeats many of Calmette's experiments this observer concludes that the intestine is not a common portal of entry for the tubercle bacilli which cause phthisis. The experiments of the English Commission again though they demonstrate "that a considerable amount of the tuberculosis of childhood is to be ascribed to infection with bacilli of the bovine type transmitted to children in meals consisting largely of milk of the cow" nevertheless do not entirely support the theory that pulmonary tuberculosis is a sequela of a primary intestinal infection as may be seen from the widely different propor-

¹ Calmette does not state that the infection in pulmonary tuberculosis is necessarily an infantile infection but merely that at whatever age infection of the lungs occurs the channel of infection is invariably the alimentary canal.]

tion of bovine and human tubercle bacilli found respectively in alimentary and in pulmonary lesions in man. Thus of nine cases of cervical gland tuberculosis in children three were found to be caused by the bovine tubercle bacillus and six by the human tubercle bacillus; and of twenty-seven cases of primary abdominal tuberculosis in children, fourteen were caused by the bovine tubercle bacillus and thirteen by the human tubercle bacillus (Cobbett and A. S. Griffith). "In these cases," the Commission remarks, "the tubercle bacillus had unquestionably been swallowed." The examination of tissues from fourteen fatal cases of primary pulmonary tuberculosis (A. S. Griffith and Cobbett) showed that in all of the cases the human tubercle bacillus alone was responsible for the disease. A. S. Griffith subsequently examined the sputum from twenty-eight cases of pulmonary tuberculosis: in twenty-six the human tubercle bacillus was the infective agent and in the remaining two the bovine tubercle bacillus (confirmed by repeated examination of the sputum).

[Baumgarten holds that tuberculous phthisis is due to infection during intra-uterine life, but this view receives very little support at the present day.]

Attempts have been made to draw a distinction between the disease as it affects the internal organs, pleuræ and peritoneum on the one hand and that form of it which affects the skin, glands, joints, etc. According to Arloing, the latter, the so-called surgical tuberculosis, are due to an attenuated bacillus which must be regarded as a separate variety. But seeing that in these localized lesions the bacillus is fully virulent, it is more likely that the slight tendency to dissemination which it exhibits is to be explained on other grounds, such as the personal resistance of the infected individual, the influence of the particular tissues in which it is growing, and the small number of the invading organisms which grow but feebly in a soil relatively unfavourable to their multiplication (Krompecher and Zimmermann).

[Arloing's theory, in so far as it relates to tubercle bacilli which infect the skin, is in part supported, and greatly amplified, by A. S. Griffith (working for the English Commission). Twenty cases of lupus were examined. The tubercle bacilli isolated from nine of them showed the cultural characteristics of the bovine tubercle bacillus, but only one had the pathogenicity ordinarily associated with that type, while the rest showed varying degrees of lesser virulence: the least virulent being no more virulent for calves and rabbits than a human tubercle bacillus but differing from the latter in that they were also of relatively slight virulence for guinea-pigs and monkeys.

[From the remaining eleven cases tubercle bacilli were isolated which had the cultural characteristics of the human tubercle bacillus; two had the full virulence of the human tubercle bacillus, the others being of lower virulence.

[It was found possible in two of the cases in which a degraded bovine bacillus was the infective agent to "increase the virulence of the culture from the original

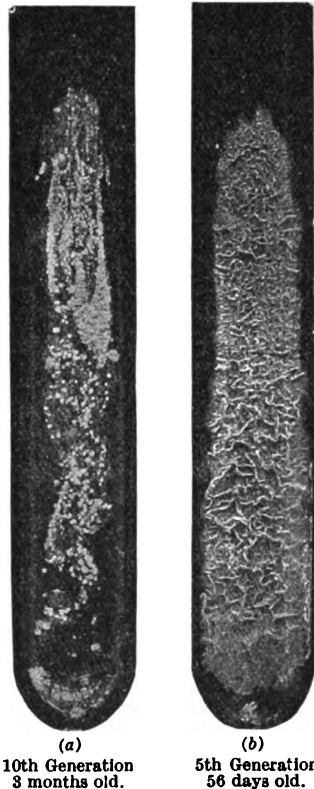

FIG. 186.—Tubercle bacilli from cases of Lupus growing on glycerin-agar. (a) The dygonic or bovine type; (b) the eugonic or human type. (This and the succeeding figure (187) are from the Final Report of the Royal Commission on Tuberculosis (Human and Bovine)—Part II. Appendix, Vol. II; Dr. A. Stanley Griffith—by permission of the Controller of H.M. Stationery Office.)

material by residence in the tissues of calf and rabbit so as to bring it up to the high virulence of the bovine tubercle bacillus"; and one of the strains of degraded human tubercle bacilli attained the full virulence of the human tubercle bacillus after residence in the body of a monkey.

No correspondence suggesting any relation between the duration or extent of the disease in the human patient and the degree of attenuation of the bacillus isolated was demonstrable in these cases.

[From thirteen cases of joint and bone tuberculosis the human tubercle bacillus with the full virulence of the type alone was isolated; in a fourteenth case both human and bovine tubercle bacilli appear to have been present (Cobbett and A. S. Griffith). These investigations therefore afford no confirmation of Arloing's theory so far as it applies to joint or gland tuberculosis.]

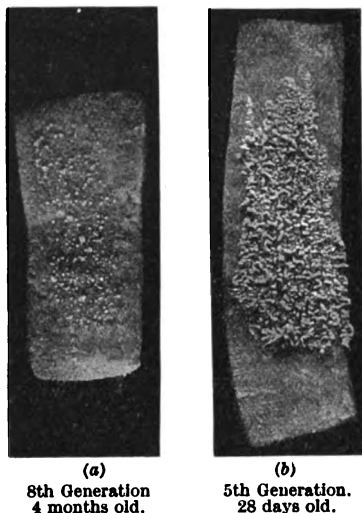

FIG. 187.—Tubercle bacilli from cases of Lupus growing on glycerin-potato. (a) The dysgonic or bovine type; (b) the eugonic or human type. (A. S. Griffith.) (See fig. 186.)

3. Tuberculosis in the lower animals.

The majority of the lower animals are susceptible to infection with tuberculosis; [The infecting agent however is not always of the same type.]

Bovine animals.—Adult animals are frequently tuberculous (3–60 per cent. varying according to the locality), [young] calves very rarely so (1 in 10,000 at the most).

Generally speaking the disease runs a chronic course. Cattle may suffer from the disease for a long time without showing any loss of weight.

The respiratory organs are most frequently affected: large, occasionally calcified, tuberculous masses (*Grapes*¹) are found in the lungs: the pleuræ and especially the bronchial glands are affected at the same time: occasionally the abdomen (mesenteric glands, liver and more rarely the spleen and kidneys) is invaded. Sometimes, especially in young cattle, the disease is mainly confined to the alimentary tract: the lymphoid structures of the intestine, the mesenteric glands, peritoneum, liver and spleen being infected. Other local manifestations of the disease are sometimes found in cattle; for instance, mammary tuberculosis (in about 1 per cent. of tuberculous animals), tuberculosis of bone, etc.

Finally, bovine tuberculosis may occur as a rapidly-spreading generalized infection resembling the miliary tuberculosis of man.

[The bovine type of tubercle bacillus has been shown to be the sole cause of bovine tuberculosis.]

Monkeys.—In these climates, monkeys frequently develop tuberculosis, and in them the disease runs a course similar to that of human tuberculosis, a characteristic feature being its tendency to become generalized. In these animals the commonest form of the disease is tuberculosis of the lung [and appears to be due mainly to the human type of tubercle bacillus (Rabinowitsch). Thus of twenty-seven cases of tuberculosis in monkeys the human type of bacillus was found in nineteen and the bovine type in three: the avian type, or modified organisms or mixtures of different types were found in the remaining five].

Dogs.—Tuberculosis is not uncommon among dogs (Cadot), though the fact has for a long time remained unrecognized. In dogs the lesions often

[¹ Fr. Pommelière; Ger. Perlucht.]

simulate malignant growths and they have been mistaken for neoplasms. Sometimes however they resemble the lesions found in man and this is especially true in cases where cavitation of the lungs has been produced.

Pigs.—Of pigs killed in public slaughter houses [in France] one to ten per thousand are infected with tuberculosis.

As a general rule, the alimentary tract is the part affected. Tuberculous otitis has been recorded in pigs: when it occurs it is probably secondary to some pharyngeal lesion which has spread up the Eustachian tube. Tuberculosis of the respiratory passages and localized tuberculous foci are not often seen. The disease is sometimes of a miliary type and runs a rapid course.

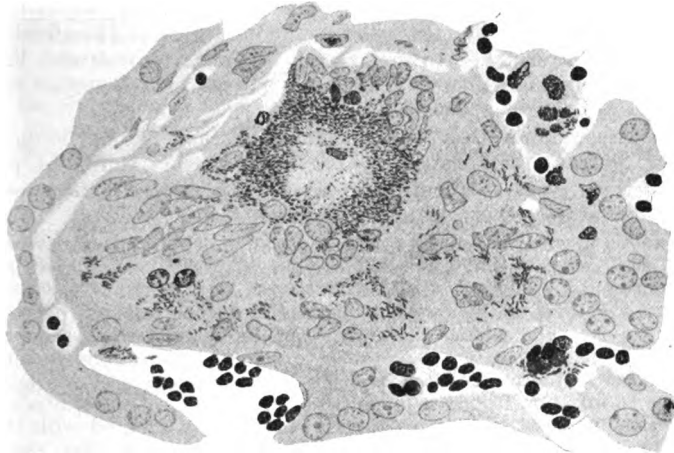

FIG. 188.—Section of the liver of a pig which died 47 days after intra-venous inoculation with 50 mg. of culture of avian tubercle bacilli. This area is typical of the condition found in the liver of this animal. Note—(1) the profuse growth of bacilli, with tendency to rosette formation; (2) the huge "giant cell" showing multiplication of nuclei by irregular longitudinal splitting; (3) the absence of wandering cells, with the exception of a few small lymphocytes; (4) the presence of numerous bacilli in the blood stream. $\times 600$. (Eastwood.)¹

[The nature of the tubercle bacilli occurring in fifty-nine cases of natural tuberculosis in swine was investigated by A. S. Griffith and F. Griffith (for the English Commission). Of these, fifty (including thirty-three cases of generalized tuberculosis) were shown to be due to the bovine tubercle bacillus; three (in which the disease was localized in the sub-maxillary glands) were caused by the human tubercle bacillus; five (in which the disease was similarly localized) by the avian tubercle bacillus; and from one (localized tuberculosis) a mixed culture of avian and bovine tubercle bacilli was obtained.

[Severe and generalized tuberculosis in the pig therefore was by this investigation shown to be due to the bovine tubercle bacillus only.]

Rabbits.—There is no foundation in fact for the popular belief that rabbits are very commonly tuberculous. Spontaneous tuberculosis in the rabbit is, on the contrary, a comparatively rare disease. When it occurs it assumes the pulmonary form.

Goats and sheep.—Both goats and sheep are liable to infection with tuberculosis but the disease in these animals is uncommon.

¹ This figure as well as figures 191, 192, 193, 198, 199, 200, 201, 202, 203, 205 and 206 are from the Final Report of the Royal Commission on Tuberculosis (Human and Bovine)—Part II. Appendix, Vol. V.; Dr. Arthur Eastwood—by permission of the Controller of H.M. Stationery Office.]

Horses.—Tuberculosis is rarely seen in horses. When it occurs it is generally of the abdominal type. A pulmonary infection is occasionally seen which may assume the character of a miliary tuberculosis or of diffuse infiltration of the lung, and large sarcoma-like masses may also occur.

[F. Griffith (for the English Commission) investigated five cases of equine tuberculosis. From three of these bovine tubercle bacilli of standard virulence were isolated; the bacilli obtained from the remaining two had the cultural characteristics of the bovine tubercle bacillus associated with a low degree of virulence for all the test animals—calf, rabbit, monkey, guinea-pig, etc. By prolonged passage experiments the virulence of the latter bacilli was increased to that of the bovine tubercle bacillus.]

Cats.—Cats are rarely tuberculous but when the disease occurs the lesions are similar to those seen in dogs. The commonest form is a localized infection of the alimentary canal. [Investigations by A. S. Griffith and F. Griffith show that the bovine tubercle bacillus is the cause of natural tuberculosis in the cat.]

Birds.—Tuberculosis is a very common disease among birds: fowls, pheasants, guinea-fowl, partridges, peacocks, parrots, birds of prey, etc. are, all of them, very frequently infected. [The disease sometimes appears as a rapidly fatal epizootic among farm-yard fowls.]

Tuberculosis in birds is usually primary in the alimentary tract developed [it is affirmed] as a result of swallowing the excreta of tuberculous animals or infected human sputum.

[The investigations of the English Commission do not support this view of the aetiology of avian tuberculosis. Their experiments would tend to show that birds (excluding the parrot) are not susceptible to mammalian tubercle bacilli.]

Tuberculosis in parrots is often associated with a bacillus of the human type and is due to infection from the human subject (Eberlein, Cadiot, Straus). From the experimental point of view parrots are most easily infected with the human tubercle bacillus, next with the bacillus of the bovine type, they appear to be least susceptible to the avian type.

In birds the liver and spleen are the organs most commonly affected: pulmonary lesions are rare though the lungs may become infected in the last stages of the disease. Except in parrots, tuberculosis of the skin, mucous membranes or joints is rarely seen. The disease may be congenital in origin the egg becoming infected in the oviduct (Baumgarten, L. Rabinowitch, Weber and Bofinger).

The histological appearances of tuberculous lesions in birds are unlike those in mammals: and moreover present different features in the various species. Not uncommonly the viscera will be found to be infiltrated with bacilli while there are no visible tubercles.

Cold-blooded vertebrata.—Tuberculous lesions have been found in the boa-constrictor, the python, the ringed snake [*Coluber natrix*—Linn.] and the frog. Dubard investigated a tuberculous condition in the carp caused by a bacillus apparently very closely related to the human bacillus.

The bacillus of *ichthic tuberculosis* is very similar to the human tubercle bacillus except that it grows badly at temperatures above 25° C. and in this respect resembles the *para-tubercle* or *acid-fast bacilli* (*vide infra*).

Cultures obtained from the carp are pathogenic to frogs, toads, lizards, tortoises, adders, the common grass snakes, carp and other fish of the same genus, etc. The bacilli are non-pathogenic to guinea-pigs and birds; but by passage through guinea-pigs the organism becomes virulent for that rodent. Ichthic tubercle bacilli when inoculated into rabbits or guinea-pigs behave in the same way as human tubercle bacilli which have become avirulent by prolonged culture on artificial media (Krompecher). Tuberculin prepared from a culture of an ichthic bacillus, which Ramond and Ravaud believe to be the same as the tuberculin obtained from a culture of the human bacillus, does not, when administered in ordinary doses, give the same reaction as Koch's tuberculin but behaves more like that produced from a culture of an avirulent human bacillus (Krompecher).

Friedmann has recovered from two cases of spontaneous pulmonary tuberculosis in tortoises a bacillus which, in many of its characteristics, differs from the ichthic bacillus and which appears to be intermediate between the ichthic and human types of tubercle bacilli. Friedmann's bacillus grows both at ordinary room-temperature and at 37° C.: it is not pathogenic to mammals but in the guinea-pig sets up a local lesion which undergoes spontaneous resolution.

4. Organisms associated with the tubercle bacillus.

In tuberculous lesions in man the tubercle bacillus is found frequently associated with various other organisms, the latter being generally of a pyogenic nature. In cavities in the lungs a rich microbial flora is encountered; the following among other organisms may for instance be found in the lungs in conditions of human pulmonary tuberculous phthisis: *staphylococci*, *streptococci*, the *pneumobacillus* of Friedlander, *pneumococci*, *bacillus pyocyaneus*, *micrococcus tetragenus*, and the bacteria of putrefaction. The hectic fever of patients suffering from tuberculosis is due to the absorption of toxins secreted by these micro-organisms of secondary infection. In glandular and meningeal tuberculosis, etc. it frequently happens that *pneumococci*, *streptococci*, and *staphylococci* are found together with the tubercle bacillus.

SECTION I.—EXPERIMENTAL INOCULATION.

Guinea-pigs or rabbits are generally inoculated with a pure culture of the bacillus emulsified in a little sterile water [or, better, sterile normal saline solution] or with tuberculous tissues pounded in a mortar with a few drops of water [or saline solution]; or the material (sputum, pus, small pieces of tissue, etc.) may be introduced directly either beneath the skin or, in the case of tissues, into the peritoneal cavity.

A. Guinea-pig.

Guinea-pigs inoculated with material containing even a few tubercle bacilli of mammalian or avian origin invariably become infected with tuberculosis.

[The high degree of virulence of the avian tubercle bacillus here suggested was not confirmed by the English Commission.]

Generally speaking, the guinea-pig is less susceptible to avian than to human or bovine tubercle bacilli. According to Weber and Bofinger, the [sub-cutaneous] inoculation of an avian tubercle bacillus leads to a localized infection in guinea-pigs, never to the typical disease. [This opinion is confirmed by the English Commission which finds that "the avian bacillus never produces a progressive tuberculosis in the guinea-pig."] This conclusion however is not supported by the work of numerous other observers.

For purposes of description the infection set up by the inoculation of a mammalian tubercle bacillus will be taken as a type.

1. **Sub-cutaneous inoculation.**—After 10 days or so there appears, at the site of inoculation, a small indurated nodule which later softens and then forms an abscess; this abscess opens externally leaving an ulcer, the so-called tuberculous chancre. At the same time, the adjacent glands become enlarged, the animal wastes, becomes cachectic and dies in from 1-3 months. *Post mortem* the most conspicuous lesions are those in the spleen and liver: the spleen is much enlarged, ochre-coloured, speckled with caseous tubercles as well as with more recent yellowish granulations; the caseous points may have become confluent giving rise to irregular whitish-yellow mammillated masses: the liver shows similar, though, as a rule, less extensive lesions. The surface of the lungs and of the kidneys and the serous membranes will be found covered with a fine sprinkling of miliary granulations. The lymphatic glands in the neighbourhood of the site of inoculation are caseous.

If the animal be killed within a fortnight to three weeks after inoculation the lesions, especially the tubercles on the spleen and liver, will be found to have attained their characteristic appearances. At this period of the disease the

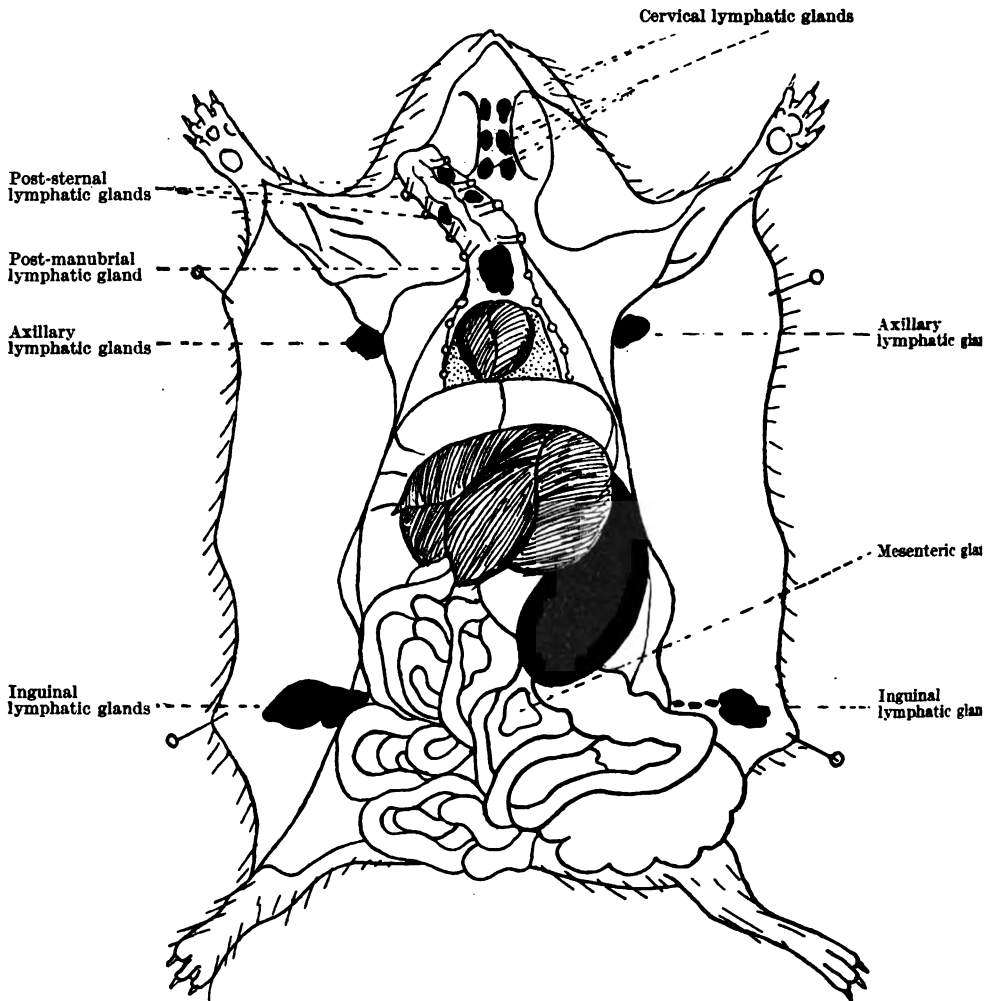

FIG. 189.—Tuberculous guinea-pig (sub-cutaneous inoculation) (3½ weeks).

The areas marked black show the structures mainly affected, viz. the inguinal, axillary, post-manubrial, post-sternal and cervical lymphatic glands and the spleen.

lesions are most marked in the glands on the same side as and adjacent to the site of inoculation. It is only towards the second month that tubercles appear in the bronchial glands and lungs.

These appearances were first described by Villemin hence this type of generalization of the disease is sometimes known as the *Villemin type*.

[The course of the disease in guinea-pigs following the sub-cutaneous inoculation of bovine tubercle bacilli was worked out by A. S. and F. Griffith. The

material was inoculated in the inguinal region. The guinea-pig killed five days later showed a local thickening only. The ten-day guinea-pig showed in addition to a local lesion, lesions in the superficial inguinal glands and in the axillary and sternal glands. The twenty-day animal showed extension of the disease to the deep inguinal, iliac and manubrial glands and to the spleen, liver and portal glands: one tubercle was found in the lung. In the thirty-day guinea-pig the disease had reached the lungs and bronchial glands, the intestines and mesenteric glands as well as the cervical, lumbar and coeliac glands. The thirty-eight day guinea-pig showed tubercles in the kidneys.

[The duration of life of the guinea-pig will depend upon the dose of tubercle bacilli administered: but the extent of the disease is not found to vary much, since an extremely small number of either bovine or human tubercle bacilli is able to set up general progressive tuberculosis in the guinea-pig (English Commission).]

2. Cutaneous inoculation.—If the inguinal region of a guinea-pig be shaved and rubbed with a piece of absorbent wool soaked in sputum containing tubercle bacilli, the corresponding glands will become enlarged a week or fortnight later and the animal will die of tuberculosis in about two months. *Post mortem*, lesions typical of the disease will be found (Osman Nouri). This method of inoculation is very useful for diagnosis, because it involves no risk of death from septicæmia, an accident very likely to happen if the material be inoculated sub-cutaneously.

3. Intra-peritoneal inoculation.—The course of the disease is similar to that just described but is more rapid. Death occurs in 2-6 weeks being preceded by an increasing degree of cachexia. Lesions similar to those already described are found in the tissues: the peritoneum is infiltrated with tubercles and the omentum forms a compact, caseous mass, while the mesenteric and inguinal glands are also caseous. The indurated nodule at the site of inoculation (chancre) is, of course, non-existent.

A large dose of an human or avian culture is fatal to guinea-pigs in a few days when inoculated intra-peritoneally. *Post mortem* there is an excess of fluid in the pleuræ but no tubercles are visible in the internal organs (Koch, Straus and Gamaléia).

[Following intra-peritoneal inoculation the course of the disease is as follows: in guinea-pigs which die in under 14 days, there is a local lesion

in the wall of the abdomen: the omentum is thickened, the mesentery and peritoneum are inflamed and covered with a thin membrane, the mesentery is also thickened: the spleen is enlarged and speckled with minute points, the liver shows minute foci, the kidneys are normal: the pleural cavities are filled with fluid, the lungs are collapsed and often consolidated and show minute grey points in the dark red areas: the pyloric, lumbar and ventral mediastinal (or sternal) glands are severely affected, the portal and other abdominal lymphatic glands less affected while the bronchial glands are usually only slightly affected. In guinea-pigs which survive for 3 weeks to a

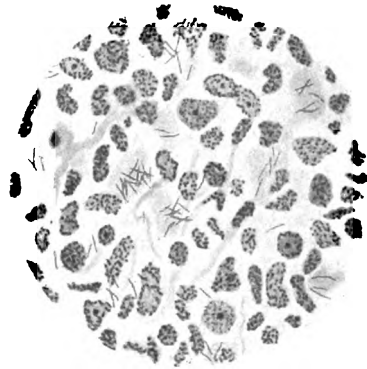

FIG. 190.—Scraping from the spleen of a tuberculous guinea-pig (carbol-fuchsin and methylene blue). (Oc. 2, obj. 1, th, Zeiss.)

month there is severe tuberculosis of the peritoneum, omentum and mesentery: the spleen is enlarged: tubercles are visible in the spleen, liver and lungs and sometimes in the kidneys: the pleural cavities sometimes contain an excess of fluid and the pleurae are covered with small grey tubercles. "With smaller and smaller doses of tubercle bacilli the lesions in the organs begin to resemble more and more those produced by sub-cutaneous inoculation" (English Commission).]

4. Intra-pulmonary inoculation.—There is a caseous focus at the point of entry of the inoculation needle and the lungs are spotted with grey tubercles in the adjacent area. In the abdominal viscera the lesions are similar to those following sub-cutaneous inoculation.

5. Inhalation.—Guinea-pigs are readily infected with tuberculosis by causing them to inhale dried and finely powdered tuberculous sputum or dust mixed with tubercle bacilli from cultures. The animal dies with well-marked caseous broncho-pneumonia.

6. Ingestion.—Guinea-pigs have been infected by feeding them with the milk of a cow suffering from tuberculous phthisis (Villemin and Parrot, Klebs). In animals infected in this way it occasionally happens that there are no lesions in the intestines. [When feeding guinea-pigs with tubercle bacilli Cobbett sometimes observed a generalized infection involving the lungs but pulmonary tuberculosis apart from a generalized infection did not occur.]

B. Rabbits.

Rabbits are not so susceptible to tuberculosis as guinea-pigs. A fatal result does not always follow the inoculation of a small amount of tuberculous material. Occasionally the local lesion is of long standing before the disease becomes generalized. Inoculation of bovine or avian tubercle bacilli is followed by a more severe infection than inoculation with human tubercle bacilli.

1. Sub-cutaneous inoculation.—According to the amount of virus inoculated the animal will live for from one to several months. A local induration (tuberculous chancre) is formed but the glands are often not affected while the lungs are, as a rule, the first to show tubercles.

The human tubercle bacillus often fails to kill rabbits when inoculated sub-cutaneously. On an average, four out of five strains of human tubercle bacilli produce only a local lesion and this undergoes spontaneous resolution. The disease resulting from inoculation of bovine bacilli is always more severe.

2. Intra-peritoneal inoculation.—The course of the disease is more rapid. Tubercles are found on the peritoneum, spleen, liver etc. Death often occurs before the disease has reached the thorax.

3. Intra-pulmonary inoculation. Inhalation.—The disease runs the same course and presents the same lesions as in the guinea-pig. Fränkel and Troje have produced caseous pneumonia in rabbits as a result of intra-tracheal inoculation.

4. Inoculation into the anterior chamber of the eye.—By inoculating the bacillus into the anterior chamber of the eye the progress of the lesions can be easily followed. During the third week, the iris becomes covered with tuberculous granulations, the eye swells, the aqueous humour becomes cloudy and occasionally the whole eye is transformed into a purulent abscess: the glands of the neck hypertrophy and infection becomes disseminated giving rise to a generalized tuberculosis of the Villemin type (p. 298).

5. Intra-venous inoculation.—The disease produced by intra-venous inoculation may be of one of two types:

(a) *Miliary tuberculosis.*—According to the amount of material inoculated

death may take place in 2 or 3 weeks. The viscera and serous membranes are covered with fine miliary tubercles.

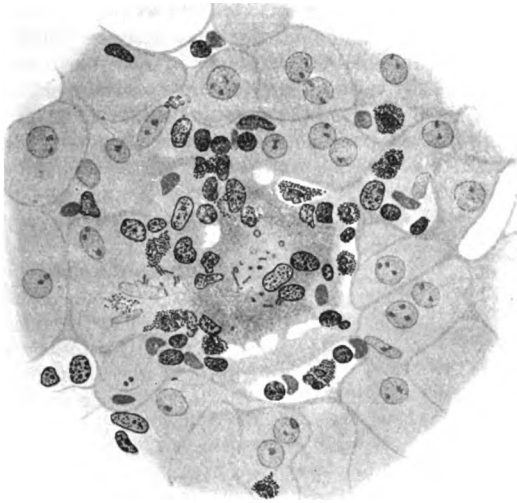

FIG. 191.—The figure represents the lesion produced in a liver of a rabbit 3 days after inoculation in the vein of an ear with 1 mg. of finely emulsified culture of mammalian tubercle bacilli and illustrates a typical tubercle, with a peripheral infiltration of small lymphocytes and finely granular oxyphil leucocytes. $\times 600$. (Eastwood.) (See footnote p. 295.)

(b) *The Yersin type*.—Death takes place in 12–25 days. The animal loses flesh and rapidly becomes cachectic. The temperature is very much raised. *Post mortem* the only visible lesion is a marked hypertrophy of the liver and spleen. There are no visible tubercles. The liver, spleen and bone marrow contain enormous numbers of bacilli.

Strauss and Gamaléia held that this second (Yersin) type of infection is the characteristic change following intra-venous inoculation of the bacillus of avian origin, but numerous facts have been brought forward to prove that intra-venous inoculation of the bacillus of human origin may result in this type of infection (Yersin, Nocard, and others). Granchez and Ledoux-Lebard have produced either of these two types of infection at will by regulating the amount of material inoculated.

Generally speaking, however, intra-venous inoculation of the rabbit with the avian bacillus produces a simple tuberculous infiltration of the organs without any visible lesions.

[The experiments of the English Commission showed that when death occurred about a fortnight after the inoculation of the *avian* tubercle bacillus into the veins, disease of the Yersin type is seen *post mortem*. But if death be postponed to a later period tubercles are visible in the internal organs.

[When rabbits were inoculated intra-venously with *bovine* tubercle bacilli they sometimes died within a fortnight of a very acute disease which did not altogether correspond to the Yersin type. In these cases the lungs were solid with masses of grey tubercles, the bronchial glands were cedematous and the spleen enlarged, there were indefinite tuberculous foci in the liver and kidneys, and on microscopical examination tubercle bacilli were found to be numerous in all the tissues of the body.

[The intra-venous inoculation of *human* tubercle bacilli will occasionally lead to an acute condition similar to that just described as sometimes following intra-venous inoculation of *bovine* tubercle bacilli.]

[The results of the inoculation experiments carried out on rabbits by Cobbett, A. S. Griffith and F. Griffith on behalf of the English Commission may be summarized here.

[The bovine tubercle bacillus produces a severe and fatal general tuberculosis whether inoculated sub-cutaneously, intra-venously or intra-peritoneally.

[The human tubercle bacillus very occasionally produces a fatal general tuberculosis when inoculated intra-venously or intra-peritoneally but as a rule the lesions found are those of a slight and retrogressive tuberculosis. Sub-cutaneous inoculation never leads to a fatal result: for example, 125 rabbits inoculated sub-cutaneously with doses varying from 1-100 mg. of culture of the human tubercle bacillus and killed after 3-24 months all showed retrogressive tuberculosis.

[The avian tubercle bacillus usually produces a fatal general tuberculosis by whichever of the three methods it be inoculated. This type is less virulent for rabbits than the bovine tubercle bacillus and it causes generally less disease of the internal organs.]

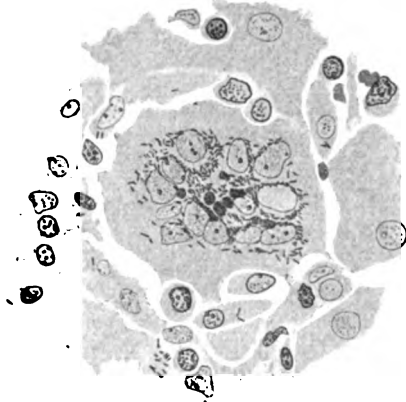

FIG. 192.—An early lesion produced in the liver of a rabbit 14 days after inoculation in the vein of an ear with 1 mg. of culture of avian tubercle bacilli. An example of a "giant cell" produced by the avian tubercle bacillus. The bacilli have been growing abundantly within the "cell" and are very small. $\times 600$. (Eastwood.) (See footnote p. 295.)

6. Infection by feeding.—The ingestion of tuberculous material mixed with food does not always lead to infection of the rabbit: some animals entirely escape the disease, others show lesions of the alimentary and respiratory tracts while the majority contract an infection strictly limited to the respiratory passages (Weleminsky). The sub-maxillary glands are first infected then the cervical glands, followed by the bronchial; finally the pulmonary parenchyma is attacked. The rabbit is more susceptible to the ingestion of bacilli of bovine or avian origin than of bacilli of human origin.

[Cobbett, A. S. Griffith and F. Griffith found that feeding with bovine tubercle bacilli was always followed by a progressive tuberculosis in rabbits while when fed with the avian tubercle bacillus only one rabbit out of seventeen fed showed severe generalized tuberculosis. Progressive tuberculosis cannot be produced in rabbits by feeding them on human tubercle bacilli.]

C. Dogs.

Dogs may be infected by inoculating them with large doses of the human tubercle bacillus but they are much more resistant to the avian bacillus though not absolutely immune to it (Grancher and Héricourt). [The dog is one of the few species of animals in which the effects produced by the bovine and human tubercle bacilli are identical. Dogs "have shown themselves insusceptible to avian tubercle bacilli inoculated by the most severe method and in relatively large doses" (work of the English Commission).]

1. Sub-cutaneous inoculation.—The disease following sub-cutaneous inoculation is not necessarily fatal: it may remain localized or become a generalized infection. [The English Commission found that the dog is resistant to the sub-cutaneous inoculation of either the bovine or the human tubercle bacillus.]

2. Intra-peritoneal inoculation.—Death occurs 2–3 months after inoculation of a pure culture of tubercle bacilli into the peritoneal cavity. Inoculation is followed by peritonitis with excess of fluid, the formation of false membranes, adhesion of the coils of the intestine, and infection of the glands. The disease, ultimately, becomes generalized. [Intraperitoneal inoculation with moderate doses of cultures of either the human or the bovine tubercle bacillus is usually but not invariably fatal (work of the English Commission).]

3. Intra-venous inoculation.—Death takes place 1–2 months after inoculation into a vein of 0.25 c.c. of a thick emulsion of bacilli from a glycerin-agar culture. The pulmonary lesions are the most marked while the liver, spleen, etc. may also show tubercles.

4. Inhalation.—Tappeiner infected dogs by causing them to breathe an atmosphere charged with dried and powdered tuberculous sputum. Lesions were found, *post mortem*, in the lungs, spleen and kidneys.

5. Infection by feeding.—Arloing fed dogs with cultures of the tubercle bacillus and in three out of seven cases found lesions in the alimentary canal; in two other cases the disease was generalized (in the spleen and lungs). [Dogs are very resistant to infection with tuberculosis by feeding, especially adult animals (A. S. Griffith and F. Griffith, for the English Commission).]

D. Cattle.

(a) *Cattle are very susceptible to infection with the bacillus of the bovine type.*



FIG. 193.—Section of the udder of a cow which died 299 days after intramammary inoculation of bacilli derived from a typical bovine virus. The specimen is taken from an affected portion of the mammary tissue showing early infection. *Note*—(1) The high vascularity, (2) the interstitial infiltration with bacilli, (3) the entrance of bacilli into the glandular epithelium, and (4) the excretion of bacilli into a mammary tubule. It is of importance to note that lesions such as this, which are obviously unrecognizable clinically, excrete numerous bacilli. Carbol-fuchsin and methylene blue. $\times 400$. (Eastwood.) (See footnote p. 295.)

In calves, infection by way of the alimentary canal leads to very severe symptoms (Vallée). [“Feeding with the bovine tubercle bacillus does not

so readily set up general progressive tuberculosis in the calf as does inoculation" (English Commission).] Feeding is the most certain method of infecting the tracheal and bronchial glands (Vallée, Calmette and Guérin). The bacilli may pass through the intestinal wall without producing any apparent lesion either of the mucous membrane or of the mesenteric glands provided that very small doses of bacilli and young animals be used, conditions, that is, similar to those obtaining in the spontaneously contracted disease (Vallée).

Calmette, Guérin and Delearde fed calves with 0.1 gram of bovine bacilli and found that they reacted to tuberculin 45 days later. The tracheal and bronchial glands were swollen and hard but not caseous, the mesenteric glands were normal in appearance, but, on inoculation, both sets infected guinea-pigs.

(b) *Cattle can also be infected with some strains of bacilli of human origin* (Chauveau, Ravenel, Arloing, M. Wolff, Schottelius, Spronck and others). [These strains were no doubt strains of bovine tubercle bacilli infecting human tissues (*vide ante*). The English Commission has demonstrated that the human tubercle bacillus is incapable of causing progressive tuberculosis in bovine animals.]

Schottelius fed bovine animals on several occasions with tuberculous sputum. In cows he found a tuberculous enteritis with caseous glands; and, in calves, caseation of the sub-maxillary and mesenteric glands. [This should be read in conjunction with the comment above. The English Commission investigated two cases of pulmonary tuberculosis in which the sole infecting agent was the bovine tubercle bacillus.] In calves, bacilli from human lesions whether inoculated beneath the skin or into the lungs or veins produced general tuberculosis (De Jong, Sturmann). Inoculation (sub-cutaneous and intra-peritoneal) of human tuberculous material into calves may lead to a rapid and generalized infection (Fibiger and Jensen, Eber) [if the bacilli of human origin are of the bovine type not otherwise (English Commission)].

In two cases in which Eber obtained a very severe infection in calves the bacilli were derived from children in whom only intestinal lesions were present. It may be admitted that the children were infected by swallowing bovine bacilli but it is no less true that human tuberculosis can infect calves and bovine tuberculosis children. [It seems to be a perfectly justifiable inference from the work of the English Commission that the bacilli used by Eber in which he produced a severe infection in calves must have been derived from children suffering from an infection with bovine bacilli. Tubercle bacilli of the human type merely give rise to a slight and retrogressive type of tuberculosis in calves and in the sense that human tuberculosis due to the bovine tubercle bacillus can infect calves the statement in the preceding paragraph is true. With regard to the reciprocal infection of children by bovine tuberculosis it may be pointed out that fourteen out of the twenty-seven cases of alimentary tuberculosis investigated by the English Commission were due to bovine tubercle bacilli.] Moreover, Eber produced an acute miliary tuberculosis with tuberculous material from an adult human being suffering from pulmonary tuberculosis and tuberculous meningitis. [Probably an infection produced by the bovine tubercle bacillus. See English Commission results, *ante*.]

Such facts [may be considered to] constitute a sufficient basis for rejecting Koch's hypothesis of the existence of two separate and distinct species of tubercle bacilli.

E. Birds.

(a) *Birds are easily infected with the avian tubercle bacillus.* Fowls may be infected by any method of inoculation (sub-cutaneous, intra-venous, feeding etc.), and the ingestion of cultures, infected tissues or other pathological tuberculous products readily produces the disease. *Post mortem* tubercles are found on the abdominal viscera but chiefly in the [spleen and] liver.

Intra-venous inoculation of the avian bacillus leads to the death of the fowl in a fortnight to three weeks with a disease of the Yersin type (*vide* also p. 301). [In the experience of the English Commission it was generally longer—5 to 6 weeks.]

(b) Those who believe that the human and avian tubercle bacilli belong to different species hold that the fowl cannot be infected with the human tubercle bacillus: but this conclusion [in the opinion of many] can no longer be maintained in view of the experiments carried out by Koch, Nocard and Cadot, and Gilbert and Roger. These observers [appear to] have shown that the fowl becomes infected with tuberculosis as the result of the ingestion of human tuberculous material and of pure cultures of human tubercle bacilli. It is [by some considered as] certain that the fowl may become infected by the ingestion of the sputum of phthisical persons.

It has to be remembered that fowls often resist infection with bacilli of human origin and that when infection does occur the disease is chronic and leads to the formation of tubercles in the internal organs. [Fowls are resistant to mammalian tubercle bacilli of whatever source when inoculated intra-peritoneally, sub-cutaneously and by feeding, but frequently succumb to intra-venous inoculations. Tubercle bacilli killed by exposure to steam at 100° C., whether avian or mammalian, may produce however similar effects when inoculated intra-venously into the fowl; these effects are therefore not a true tuberculosis but are to be attributed to the toxic action of the bacilli (F. Griffith, for the English Commission).]

F. Cold-blooded animals.

Frogs and fish do not appear capable of infection with bacilli of human and avian origin. But there is an observation to the effect that true tubercles have been produced by inoculating bacilli of human origin into the peritoneal cavity of frogs and carp (Moret).

Bertarelli [is stated to have] succeeded in infecting snakes (*Varanus varius*) by inoculating them under the skin with human tuberculous sputum but failed with cultures of bacilli of avian origin.

Moeller infected the blind worm [*Anguis fragilis*] with bacilli of human origin (p. 334).

Sorgo and Suess produced tuberculous lesions (caseating masses [at the site of inoculation] and occasionally generalization) in two blind worms and four snakes with bacilli of human origin, though many of their experiments were negative. In blind worms the bacilli retain all the characteristics associated with the human tubercle bacillus but in snakes they [are said to] undergo a partial change and to develop some of the characteristics of bacilli of ichthid origin.

SECTION II.—MORPHOLOGY.

1. Microscopical appearance.

Human, avian and ichthid tubercle bacilli all have, in the main, the same characteristics. In cultures they are small, very slender, generally non-motile, rods.

Ferran says that the tubercle bacillus is motile, but the conclusions arrived at in his paper cannot all be accepted unreservedly. Arloing confirms Ferran's opinion. By sub-cultivating a glycerin-potato culture on to glycerin-broth this observer obtained motile bacilli. Schumowsky, in a similar experiment, also found motile bacilli. Auclair [is said to have] succeeded in converting the tubercle bacillus into a motile saprophyte, etc.

In cultures on solid media the bacilli are arranged in long wavy coils some-

thing like a moustache due to the regular interlocking of the bacilli with a common orientation.

This arrangement of the bacilli can be readily shown by lightly pressing a cover-glass on the surface of a glycerin-agar culture and lifting it off without friction. The film should be fixed by heat and stained by one or other of the methods described below. On examining with an oil-immersion lens the appearances reproduced in fig. 194 will be seen.

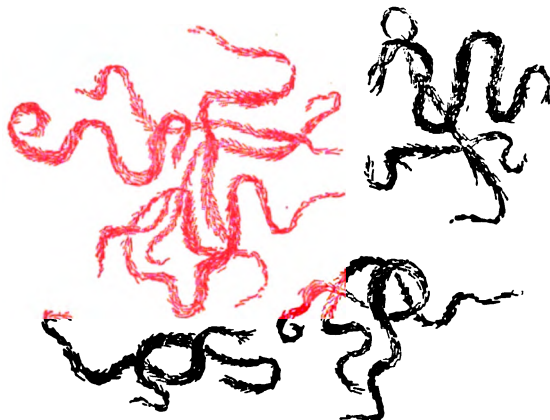

FIG. 194.—Tubercle bacillus: impression preparation. (After Koch.) $\times 700$.

The bacillus must be stained before it can be found in fluids and tissues and it will be necessary to describe the various methods of staining before embarking upon a description of its characteristics.

Staining methods.

Special methods have to be adopted in order to stain the tubercle bacillus.

The tubercle bacillus is difficult to stain with the basic aniline dyes but once stained it resists the decolourizing action of such powerful agents as dilute mineral acids. Only two other pathogenic bacilli share this characteristic with the tubercle bacillus viz. the leprosy bacillus from which it is easily distinguished and the bacillus of Verruga peruana.¹

This acid-fast property of the tubercle bacillus serves as a means of diagnosing the organism in fluids and tissues in which it is present. The property of resisting the decolourizing action of acids seems to be due to the presence of a fatty or waxy substance insoluble in alcohol and ether (Koch, Tavel, Viquerat). By treating the bacilli with warm xylol, Borrel extracted a waxy substance which was acid-fast while the bacilli had lost this property.²

¹ Besides these two there are a few other bacilli, like the tubercle bacillus, capable when deeply stained of resisting the decolourizing action of dilute acids. Such, for instance, are the smegma bacillus and the bacillus of Tavel (the so-called syphilis bacillus of Lustgarten)—but these, unlike the tubercle bacillus, are decolourized by absolute alcohol or ether—likewise the various acid-fast bacilli of Bienstock, Gottstein, Møller, Rabinowitch, etc. (*Vide infra, The acid-fast bacilli.*)

² In opposition to the opinion expressed by H. Aronson, Sabrazès has shown that by treating tissues for sections with ether, xylol and chloroform the characteristic staining properties of the tubercle bacillus are in no way interfered with. And the same is true of picric acid, carbolic acid and perchloride of mercury none of which prevent subsequent staining by the Ziehl-Neelsen method. On the other hand, undiluted mineral acids, 2 per cent. chromic acid, formalin, bichromates, osmic acid, etc. either interfere with or entirely prevent subsequent staining by the carbol-fuchsin method. [Eastwood, however, working for the English Commission hardened tissues in formalin (p. 338).]

Numerous methods of staining the tubercle bacillus have been suggested, but they all depend upon the principle enunciated above.

The various methods in most frequent use will now be described, but the necessity for beginners to limit themselves to *one* method which they thoroughly understand and upon the results of which they can rely cannot be too strongly emphasized. The Ziehl-Neelsen method is by far the best.

The tubercle bacillus stains by Gram's method but with difficulty and the stain, carbol- or anilin-gentian-violet (Nicolle), must be allowed to act for, at least, 10 minutes. The bacilli are always granular by this method.

Much has shown that in cattle inoculated with tuberculosis, tuberculous nodules are often seen, *post mortem*, in the lungs in which no bacilli can be demonstrated by Ziehl's method, though the presence of bacilli in the lesions is proved by the result of inoculations (the same is true of "cold abscesses" in man). If, however, Gram's method of staining be adopted, leaving the preparations in the violet for 48 hours and in the iodine solution for 24 hours, large numbers of bacilli can be seen in the lesions. From this observation Much concludes that in addition to the acid-fast tubercle bacillus there is a virulent form which is non-acid-fast.

A. The staining of films.

1. Ziehl-Neelsen method.

Method recommended.

The principle of the method.—If a film stained with carbol-fuchsin be treated with a diluted mineral acid, the background and all the organisms, with the exception of the tubercle bacillus (and also those of leprosy, verruga and the "acid-fast" bacilli, pp. 350 and 345), will be decolourized. The tubercle bacillus retains its red colour. If, now, the preparation be stained with an aqueous solution of methylene blue, the background and the decolourized organisms take up the blue while the tubercle bacillus remains red.

Technique.—1. Spread, dry and fix a film on a cover-glass in the ordinary way. Hold it in a pair of Cornet's forceps and flood it with a large drop of



FIG. 195.—Tubercle bacilli in sputum. Carbol-fuchsin and methylene blue.
(Oc. 2, obj. 1/14th, Zeiss.)

Ziehl's carbol-fuchsin (p. 138). Hold the cover-glass over a small flame (the pilot light of a Bunsen, for example) and heat very gently until steam just begins to rise; continue the heating for two minutes, being careful not to boil the stain and to see that the staining solution does not dry up.

2. Pour off the stain and treat for a few seconds with a 33 per cent. solution of nitric acid (distilled water 2 volumes, pure nitric acid 1 volume) or a 25 per cent. solution of sulphuric acid (distilled water, 3 volumes, pure sulphuric acid, 1 volume), [or 25 per cent. hydrochloric acid (Eastwood)]. The preparation now assumes a yellowish tint.

[This method of decolourization appears to be perfectly satisfactory in the case of bacilli from cultures and was moreover the method adopted by Eastwood in his work for the English Commission. But it is undoubtedly true that tubercle bacilli direct from human and animal tissues—in sputum, for example—will sometimes lose the stain in these strong acids. In searching for the tubercle bacillus therefore in fresh material in which its presence is suspected it is recommended that a 2·5 per cent. solution of sulphuric or hydrochloric acid be used and that the film be not exposed to the acid for a longer time than is absolutely necessary.]

3. Wash freely in water: the preparation should now be pale pink, and if the pale pink colour does not appear, the decolourization has been insufficient and the film must be treated with acid again.

4. Pour a few drops of absolute alcohol on the film: when decolourization is complete the film should be a very faint pink colour.

By using alcohol decolourization can be pushed much further than would be possible with acid since the latter would ultimately decolourize the tubercle bacillus. A further advantage in using alcohol is that it decolourizes the smegma bacillus and thus a possible source of error is eliminated.

5. Wash well in water. Stain for a few moments with an aqueous solution of methylene blue.

6. Wash in water. Dry. Mount in balsam.

Note.—When it is merely a question of searching for the tubercle bacillus it is a great advantage not to counterstain the background after decolourizing with alcohol; the tubercle bacilli are much more easily seen when they appear stained deep red on an unstained or faintly pink background.

For this purpose the above procedure is stopped at the end of Stage 4 and, after washing, the preparation is examined in water. If after examination it be thought desirable to keep the film it may be counterstained with blue and treated as described above.

This simpler method is particularly applicable when the bacilli are likely to be present in small numbers; in any case it renders the detection of the bacilli more rapid, and beginners will find it of great use.

2. Ehrlich's method.

1. Stain the film for 5 minutes in the warm with aniline-violet.
2. Decolourize in 33 per cent. nitric acid for a few seconds.
3. Wash in water: continue the decolourization with absolute alcohol.
4. Stain for a few seconds in the cold in a saturated aqueous solution of vesuvin.
5. Wash. Dry. Mount.

The tubercle bacilli are stained violet, other structures brown.

3. Gabbé's method.

This method is merely a modification of Ziehl's but is less reliable and more difficult.

1. Stain with carbol-fuchsin as above.
2. Decolourize and counterstain at the same time by dipping the film for a minute in the following solution.

| | | | | | | | | | |
|------------------------------|---|---|---|---|---|---|---|---|----------|
| Methylene blue, | - | - | - | - | - | - | - | - | 2 grams. |
| 25 per cent. sulphuric acid, | - | - | - | - | - | - | - | - | 100 c.c. |

3. Wash. Dry. Mount.

The methods described by Stocquart, by Pithion and Roux (of Lyon) are modifications of the above but are of no interest.

4. Spengler's method.

1. Stain the films by gently warming them in Ziehl's solution.
2. Treat for a few seconds with picric-alcohol.

| | |
|--|---------|
| Saturated aqueous solution of picric acid, - - - - | 60 c.c. |
| 95 per cent. alcohol, - - - - | 40 " |
3. Wash three times in 60 per cent. alcohol.
4. Decolourize rapidly (about 20 seconds) in 1 in 6 nitric acid, then in 60 per cent. alcohol.
5. Treat again with picric-alcohol. Wash. Dry. Mount.

5. Fränkel's method.

1. Stain the films in the warm for 5 minutes with aniline-fuchsin (prepared in the same way as aniline-violet using an alcoholic solution of fuchsin instead of alcoholic gentian-violet).
2. Transfer the films direct to the following solution for 1 minute.

| | |
|---|------------------------------------|
| 90 per cent. alcohol, - - - - | 50 c.c. |
| Aniline water, - - - - | 30 " |
| Pure nitric acid, - - - - | 20 " |
| Saturated alcoholic solution of methylene blue, - - - - | Q.S. to obtain a deep blue colour. |
3. Wash in distilled water. Dry. Mount.

6. Herman's method.

Prepare the following solutions :

- | | |
|---------------------------------------|----------|
| A. Krystal violet, - - - - | 1 gram. |
| 95 per cent. alcohol, - - - - | 30 c.c. |
| B. Ammonium carbonate, - - - - | 1 gram. |
| Distilled water, - - - - | 100 c.c. |

Immediately before use, pour three parts of solution B into a watch-glass, add one part of solution A and mix intimately.

1. Heat the staining bath until it just begins to boil and leave the films in it for a minute.
2. Transfer the films to a 10 per cent. solution of nitric acid for 4 or 5 seconds.
3. Wash in absolute alcohol to complete the decolourization.



FIG. 196.—Tubercle bacilli in sputum : Herman's method.
(Oc. 2, obj. λ_{13} th, Zeiss.)

4. Transfer the films for 30 seconds to the following solution :

| | |
|-------------------------------|----------|
| Eosin, - - - - | 1 gram. |
| 60 per cent. alcohol, - - - - | 100 c.c. |
5. Wash very rapidly in alcohol. Dry. Mount. The tubercle bacilli are stained violet and the background bright pink.

7. Lustgarten's method (modified).

Sabouraud, by slightly modifying the method devised by Lustgarten for staining his so-called bacillus of syphilis, has perfected a method of staining the tubercle bacillus which he affirms to be very delicate and precise. The method is as follows:

1. Stain the film in Ziehl's solution in the cold for 1 or 2 hours or at 50° C. for 15 minutes.

2. Treat the film for 1-3 seconds with a 1.5 per cent. solution of potassium permanganate.

3. Dip at once into a freshly prepared, saturated, aqueous solution of sulphurous acid for a few seconds until the film is decolourized.

The sulphurous acid solution can be conveniently prepared by bubbling the gas from a cylinder of liquefied sulphurous acid through distilled water.

4. Wash in water and counterstain with an aqueous solution of methylene blue for 1-3 minutes.

5. Wash in water. Dry. Mount in balsam.

8. Koch's method.

This, the earliest method used for the detection of the tubercle bacillus, is chiefly of historical interest.

1. Place the films for 1 day at room temperature or for a few hours at 45°-50° C. in the following bath:

| | |
|---|--------|
| Saturated alcoholic solution of methylene blue, - - - | 1 c.c. |
| 10 per cent. aqueous solution of potash, - - - | 2 " |
| Distilled water, - - - | 200 " |

2. Transfer the films to a saturated aqueous solution of vesuvin; in about a quarter of an hour a brown tint takes the place of the original blue colour save in the tubercle bacilli which still retain the blue stain.

B. The staining of sections.

The methods just described are applicable with slight modification to the staining of sections: but in this case it is essential that the *staining should always be done in the cold.*

1. Ziehl-Neelsen's method.**Method recommended.**

1. Stain the section in the cold for 15-30 minutes in Ziehl's fuchsin.

2. Decolourize in the acid solution for a few seconds. Wash in water.

3. Continue the decolourization with absolute alcohol until the section is a pale pink colour. Wash in water.

4. Stain the groundwork with an aqueous solution of methylene blue.

5. Wash. Pass rapidly through absolute alcohol, clove oil, and xylol. Mount in balsam.

2. Kühne's method.**Method recommended.**

The following unpublished method of Kühne has been quoted by Borrel. It is particularly useful for staining sections of lung. The action of the hydrochloride of aniline, which is the decolourizing agent used, is not so rough as that of mineral acids and does not alter the arrangement and shape of the cells.

1. Stain the section for 2 minutes in Böhmer's hæmatoxylin or hæmatein (p. 218) to stain the nuclei of the cells. Wash in distilled water.

2. Stain in the cold with Ziehl's fuchsin for a quarter of an hour.

3. Decolourize for 30-60 seconds in a 2 per cent. aqueous solution of aniline hydrochloride.

4. Continue the decolourization with absolute alcohol.

The cells of the groundwork are now unstained with the exception of the nuclei.

The section may be treated with orange-yellow which stains particularly the red cells of the blood. After staining with orange, dehydrate in absolute alcohol.

5. Clear in clove oil and xylol. Mount in balsam.

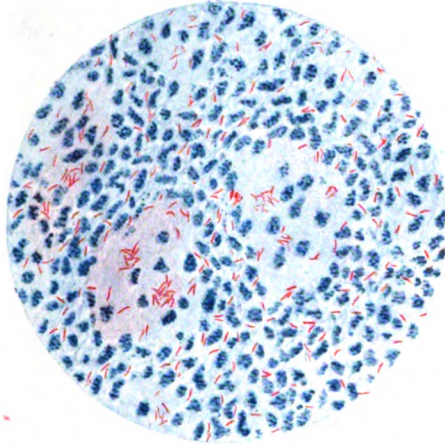

FIG. 197.—Section of human tuberculous lung. Carbol-fuchsin and methylene blue. (Oc. 2, obj. 1/3th, Zeiss.)

3. Ehrlich's method.

1. Stain in aniline-violet for 12 hours in the cold.
2. Decolourize in 33 per cent. nitric acid for a few seconds. Wash.
3. Complete the decolourization in absolute alcohol.
4. Counterstain with a saturated aqueous solution of vesuvin.
5. Dehydrate rapidly in absolute alcohol. Clear with clove oil and xylol. Mount in balsam.

4. Letulle's method.

1. Stain the nuclei with hæmatoxylin as in Kühne's method. Wash in distilled water.
2. Stain with Ziehl's fuchsin in the cold for a quarter of an hour. Wash rapidly in distilled water.
3. Wash in absolute alcohol for 30 seconds.
4. Treat with the following solution for 5 minutes :

| | | | | | | | | | | |
|--|---|---|---|---|---|---|---|---|---|----------|
| Iodgrün, - | - | - | - | - | - | - | - | - | - | 1 gram. |
| 2 per cent. solution of carbolic acid, - | - | - | - | - | - | - | - | - | - | 100 c.c. |
5. Decolourize in absolute alcohol.
6. Clear in clove oil and xylol. Mount in balsam.

The groundwork is stained very pale grey-lilac; the nuclei, violet; the bacilli, deep red. This method can be used for tissues hardened in Müller's fluid.

5. Herman's method.

Herman's method (p. 309) can, according to its author, be applied to the staining of frozen sections of tissues fixed in acetic perchloride solution. The technique is the same as for films, the stain being allowed to act for 1 minute with steam rising.

6. Lustgarten's method (modified).

1. Stain for some hours in the cold in carbol-fuchsin.
- 2, 3, 4, 5. As for films (p. 310).
6. Wash in water. Dehydrate rapidly in absolute alcohol.
7. Clear in clove oil and xylol. Mount in balsam.

This method is useful when searching for bacilli in sections of the liver, where they are often difficult to find. It is also available for tissues hardened in Müller's fluid.

Appearance of the bacilli in stained preparations.

In stained preparations, tubercle bacilli vary in length from $2-5\mu$ and in breadth from $0.3-0.5\mu$. They are generally of the same thickness throughout. In some preparations the bacilli are homogeneous, while in others they appear as though composed of a number of small oval or rounded grains separated



FIG. 198.



FIG. 199.

FIG. 198.—From a culture, 20 days old, on inspissated horse serum, of a mammalian virus of low experimental pathogenicity to bovines and rabbits and of vigorous cultural growth. The virus was isolated from a human being. The bacilli are very short; some of them show a central constriction. The clump at the bottom of the figure illustrates the tendency of mammalian bacilli to stick together and the difficulty of separating them by emulsification. The bacilli from serum cultures of this virus proved shorter than the average vigorously growing bacillus of human origin. This figure illustrates the impossibility of distinguishing with certainty, under the microscope, "human" from "bovine" bacilli. Carbol-fuchsin. $\times 2150$. (Eastwood.) (See footnote p. 295.)

FIG. 199.—From a culture, 22 days old, on glycerinated broth, of a typical mammalian virus of low pathogenicity to experimental animals and of vigorous cultural growth. The virus was isolated from a human being. The bacilli, obtained from a copious growth, are for the most part long and curved, and with a tendency to beading. Carbol-fuchsin. $\times 2150$. (Eastwood.) (See footnote p. 295.)



FIG. 200.



FIG. 201.

FIG. 200.—From a culture, 44 days old, on glycerin-agar, of a mammalian virus which was isolated from the bronchial gland of a human being. The occurrence of branched forms of the mammalian tubercle bacillus in cultures obtained from ordinary media, such as glycerinated agar, broth, or potato, is, in Eastwood's experience, extremely rare. The figure also shows other forms of bacilli, some very long, some very short, and many with globular or oval, darkly stained bodies variously situated. Bacilli with such appearances as these are common in agar cultures. Carbol-fuchsin. $\times 2150$. (Eastwood.) (See footnote p. 295.)

FIG. 201.—Tubercle bacilli from milk obtained from the udder of a cow, which had received an intra-mammary inoculation with a typical bovine virus. The bacilli are of various lengths; many of them are curved and regularly beaded. The bacilli here shown are such as are commonly met with in cow's milk; it would obviously be impossible for anyone to decide, on morphological grounds, that they were of bovine rather than of human origin. Carbol-fuchsin. $\times 2150$. (Eastwood.) (See footnote p. 295.)

by clear unstained intervals. They are sometimes straight but more often somewhat S-shaped or bent on themselves.

[According to Eastwood (working for the English Commission) mammalian tubercle bacilli when grown on serum are of a very uniform character; straight, uniformly stained and about 1μ long but ranging from $0.75-2.5\mu$. On media containing glycerin the average length is greater: in the same film, short (1μ) bacilli, longer ($2-4\mu$) forms and very long ($5-7$ or 8μ) forms

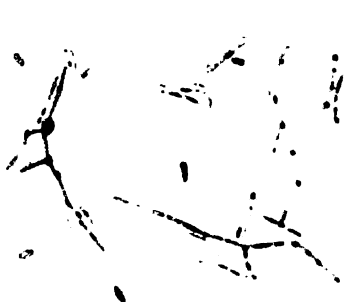

FIG. 202.



FIG. 203.

FIG. 202.—Tubercle bacilli from a culture, 2 months old, on glycerin-agar, of a typical avian virus. In addition to short forms, long branching forms are found. The branching frequently emanates from a darkly stained spherical point, which in some instances is of a greater diameter than the breadth of the bacillus. Branching is much commoner with the avian than with the mammalian bacillus. Carbol-fuchsin. $\times 2150$. (Eastwood.) (See footnote p. 295.)

FIG. 203.—Tubercle bacilli from a culture, 2 months old, on glycerinated potato, of a typical avian virus (same virus as fig. 202). The bacilli show a tendency to grow in long, parallel threads. Carbol-fuchsin. $\times 2150$. (Eastwood.) (See footnote p. 295.)

may all be encountered and on these media the bacilli are frequently curved and many are stained irregularly (beaded and globular forms). Branched forms are very rarely indeed seen in cultures.

[Avian tubercle bacilli grown on glycerin serum are generally very short ($0.5-1\mu$) and rather thick. On other media they are as a rule longer and more irregular. Among these irregular forms can be found examples of all the forms assumed by the mammalian bacilli; and large club-shaped swellings are not uncommonly seen while branching occurs more frequently than with the mammalian bacillus.]

Koch regarded as spores the unstained intervals which are sometimes seen in the bacilli. There is now a tendency to regard the deeply stained granules seen at the ends or in the length of some bacilli as spores (Babès, Ehrlich). Gavina thinks that he has stained terminal spores in bacilli grown in presence of antiseptics.

In cultures extraordinarily short bacilli are occasionally seen. In other cases, particularly in old cultures, large, branched bacilli ending in a club-shaped swelling are found (fig. 204). These giant forms afford



FIG. 204.—Involution forms of the tubercle bacillus. (After Metchnikoff.)

ground for grouping the tubercle bacillus with the streptothrices. Copen-Jones [and Eastwood] have described ray structures with club-shaped ends in tuberculous lesions exactly similar to the structures seen in the grains of actinomycosis (figs. 205 and 206).

In sputum and in tuberculous tissues the bacilli are found singly or arranged in groups and in the latter case may lie parallel to one another. Occasionally two bacilli are seen crossing one another at a more or less acute angle or arranged like a V.

[Bacilli obtained from the living tissues are longer and not so uniform in appearance as bacilli cultivated on serum (Eastwood).

[Both mammalian and avian bacilli when growing freely in the tissues of their host are usually shorter and more uniformly stained than those which are growing under adverse conditions.]

2. Cultural characteristics.

A. Conditions of growth.

The tubercle bacillus only grows in artificial culture provided that the medium contains serum (Koch), glycerin (Nocard and Roux), yolk of egg (Dorset), or fragments of tissues (Lumière).

It is an aërobic organism and only grows at temperatures above 30° C. In the case of human tubercle bacilli growth ceases at 41° C. and in the case of bovine bacilli at 44°–45° C. The optimum temperature is 38° C.

Certain precautions must be observed in *sowing* the tubercle bacillus. For preference, the material will be taken from a lesion in the guinea-pig or rabbit (bacilli taken directly from human tissues grow badly on artificial media), rubbed up in a sterile mortar and portions of it transferred with a stout wire to tubes of coagulated serum. It is better [when sowing cultures of the human tubercle bacillus] to use serum to which 4 per cent. of glycerin has been added before coagulation or blood agar. Never sow tuberculous tissue directly on to glycerin agar: the cultures are more than likely to fail. It is immaterial if the surface of the medium be slightly torn. Sow a large number of tubes as many of them will remain sterile [and others are likely to be contaminated with other organisms]. Incubate at 37°–38° C. Growth only becomes visible to the naked eye after an interval of 12 days or so but continues to increase for about 4 weeks. As soon as colonies appear in any tube cover the mouth with an india-rubber cap to prevent evaporation and the consequent drying up of the medium. [It is perhaps even better to seal the tube with paraffin or sealing-wax.]

When a growth has been obtained, sub-cultures can be sown on various media; it is always advisable to sow a good deal of material and [until a fair amount of experience has been acquired] to sow several tubes.

[The human tubercle bacillus grows more luxuriantly than the bovine tubercle bacillus in artificial culture so that the former is sometimes described as the *eugonic* and the latter as the *dysgonic* tubercle bacillus.]

Cultures of the tubercle bacillus have a characteristic but rather pleasant odour.

B. Characters of growth on various media.

1. **Coagulated serum.** (a) *The bacillus of the human type.*—After the culture has been incubating at 37°–38° C. for 12 days or so a number of small, white, round, scaly, dry-looking colonies are seen scattered over the surface of the medium. On further incubation the colonies become raised but retain their scaly appearance, and the margins are irregular in outline. Generally speaking, and especially when recently isolated, the colonies do

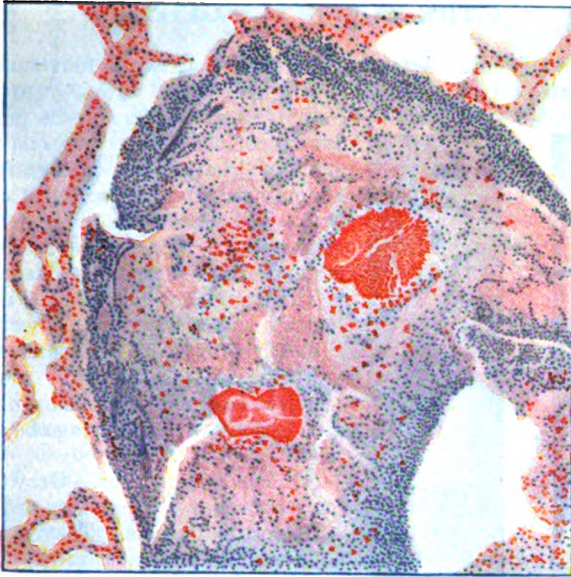

FIG. 205.—Lung of a rabbit, killed 63 days after inoculation, partly intravenously and partly intra-peritoneally, with a total of 140 mg. of killed culture of bacilli of bovine origin. This figure is a representative example of numerous lesions found in the lungs. The material which stains strongly with eosin bears a curious resemblance to actinomycetes. The lesion as a whole is abundantly infiltrated with finely granular oxyphil leucocytes. As carbol-fuchsin has not been applied, no bacilli are stained. Eosin and methylene blue. $\times 112$. (Eastwood.) (See footnote p. 295.)

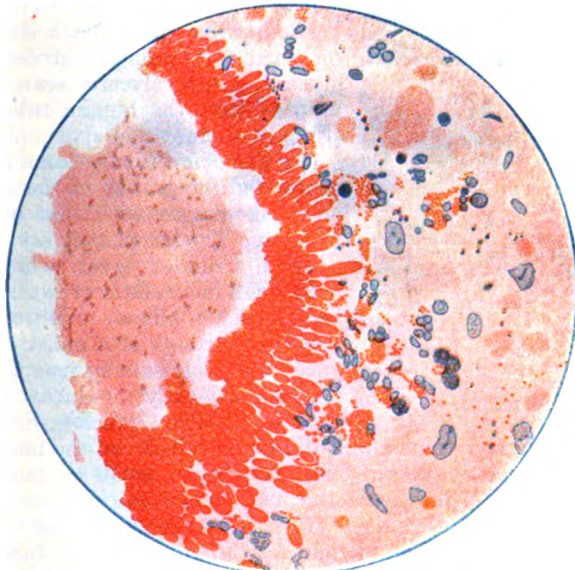

FIG. 206.—From the same lung as fig. 205, the specimen having been stained with carbol-fuchsin before counterstaining with eosin and methylene blue. A portion of one of the actinomycetes-like nodules. The club formation may perhaps be attributable to dissolved constituents of the large number of dead bacilli inoculated. Some bacilli not yet disintegrated are seen in the lower part of the field. The abundance of multinuclear leucocytes, which are shedding their granules, suggests that the disintegration of the dead bacilli is due to the digestive action of these cells. Carbol-fuchsin, eosin and methylene blue. $\times 865$. (Eastwood.) (See footnote p. 295.)

not become confluent. After sub-cultivating three or four times, however, they may coalesce to form a dried wrinkled layer.

[(β) *The bovine type*.—On pure serum the growth of the bovine tubercle bacillus presents no marked differences from that of the human tubercle bacillus.]

(γ) *The avian type*.—The bacillus of avian origin yields a more abundant growth on serum than the human bacillus. The culture is thick and generally has a moist, greasy lustre.

2. Glycerin agar.—Except for primary cultures, this is the best medium upon which to grow the tubercle bacillus. A little glucose may with advantage be added to the medium (p. 44).

(a) *The human type*.—Growth begins as on serum but the colonies are both larger and more numerous. They rapidly become confluent and form a thick, whitish, dry, rough, scaly, mammilated layer even in recently isolated specimens and after being sub-cultivated a few times on glycerin-agar the growth becomes very abundant, moist, greasy and folded. When old the growth has a reddish tint.

[(β) *The bovine type*.—The bovine tubercle bacillus grows much less luxuriantly on media containing glycerin—such as glycerin-serum, glycerin-agar, or glycerin-potato—than the human tubercle bacillus (English Commission).]

(γ) *The avian type*.—Some authors have contrasted the growth of the avian bacillus on glycerin-agar with that of the human bacillus. The latter, they say, gives rise to a dried, wrinkled layer, while the former produces a moist, fatty growth. But as has been seen, the human type frequently gives a copious growth of a moist, fatty appearance: and it is equally true that the avian type occasionally produces a dry, scaly growth (Nocard, Grancher, Fischel).

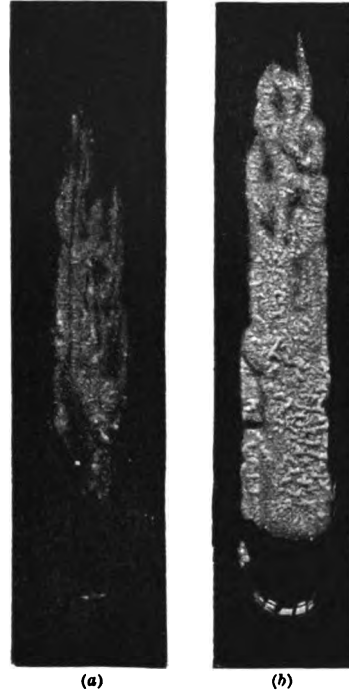

(a)
4th Generation
51 days old.

(b)
4th Generation
3 weeks old.

FIG. 207.—Tubercle bacilli of human origin cultivated on glycerin-agar. (a) A culture from the tuberculous mesenteric glands of a child aged 8½ years, who died from multiple stricture of the gut (due to tuberculous ulceration). The culture grew moderately well on artificial media, and resembled the more easy-growing cultures of bovine origin; it had high virulence for the calf, rabbit and guinea-pig. (b) A culture from a mesenteric gland of a case of general tuberculosis originating in the alimentary tract in a child aged 10 months. The strain grew luxuriantly on media containing glycerin and was only slightly virulent for the rabbit (A. S. Griffith).¹

[“The most characteristic point of difference between the mammalian and avian tubercle bacilli is that the cultures of avian bacilli are moist and easily emulsified, while on most media the mammalian cultures are dry and can only be broken up with difficulty” (F. Griffith, for the English Commission).]

3. Egg medium.—A useful medium for the growth of the tubercle bacillus consists of the white and yolk of eggs coagulated and sterilized by discontinuous heating at 72°–74° C. (Dorset, Capaldi, A. S. Griffith).

Bezançon and Griffon mix one part of uncooked yolk of egg with two parts

¹ Fig. 207 and also figs. 208, 209, 210, and 211 are from the Final Report of the Royal Commission on Tuberculosis (Human and Bovine)—Part II. Appendix, Vol. I.; Dr. A. Stanley Griffith—by permission of the Controller of H.M. Stationery Office.]

of 6 per cent. glycerin-agar melted in a water bath and kept at 50° C. The ingredients are mixed as thoroughly as possible and the tubes allowed to set in a sloped position. From human lesions, moist, greasy-looking colonies can be obtained in a week on this medium.

Phisalix prepares a medium by mixing yolk of egg with a potato mash containing a little glycerin. The medium is sterilized in the autoclave. Lubenau gives a method which has already been described (p. 54).

According to Park, yolk of egg media are particularly useful for the isolation of tubercle bacilli from tuberculous material and for the differentiation of the human from the bovine type.

On media made with yolk of egg but containing no glycerin bacilli of the bovine type grow easily: and on the same media but containing glycerin bacilli of the human type grow poorly at first while the bovine type does not grow at all.

[According to A. S. Griffith (English Commission) the egg medium is invaluable for obtaining the tubercle bacillus in pure culture from tissues or other material. It is of great value also for sub-cultures; on it the tubercle bacillus retains its vitality for a longer period than on any other medium, and sub-cultures can often be obtained on this medium from old cultures which fail to grow when sown on other media. He gives the following method of preparation of the medium—"The yolk and the white of fresh eggs are thoroughly mixed by shaking in a flask; salt solution is added in the proportion of one to three of egg; the mixture is filtered through muslin, distributed into tubes, sloped and coagulated in a serum inspissator at 80° C."]

4. Blood-agar.—Bezançon and Griffon recommend the addition of rabbit-blood to agar for starting cultures from human or animal tissues. Growth appears early and soon becomes very copious, the colonies absorb the hæmoglobin and become chocolate-coloured.

5. Tochtermann's agar.—Dissolve 10 grams of peptone, 5 grams of sodium chloride, 5 grams of glucose and 20 grams of agar in a litre of water. Add half-a-litre of calf serum, mix, boil for 15 or 30 minutes, filter in the warm, distribute into tubes and sterilize at 100° C. for 50 minutes.

6. Hesse's agar.—For obtaining cultures of the tubercle bacillus from human sputum Hesse recommends sowing the material on the surface of a special agar prepared as follows:

Dissolve 5 grams of salt, 30 grams of glycerin, and 20 grams of agar in a litre of water. Add 5 c.c. of a normal solution of carbonate of sodium and 5 grams of Heyden's albumose (*Nährstoff Heyden*) dissolved in 50 c.c. of water.

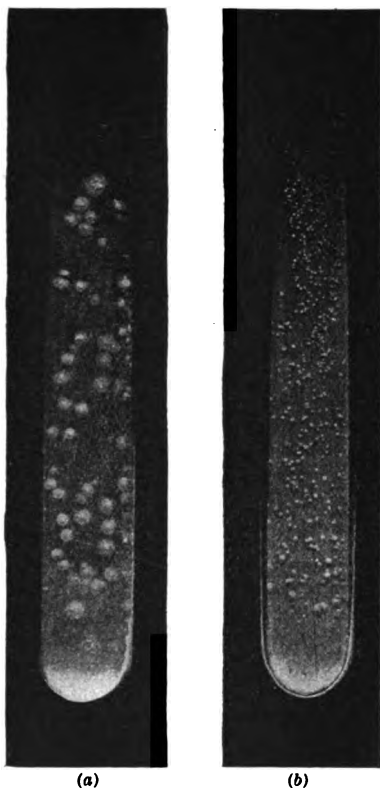

FIG. 208.—Primary cultures of tubercle bacilli on the egg medium. (a) Bovine tubercle bacilli of human origin obtained direct from sputum by means of antiformin; (b) Human tubercle bacilli (A. S. Griffith). (See footnote p. 316.)

Boil for 15 minutes. Filter in the warm. Sterilize at 100° C. and pour into Petri dishes.

7. Fragments of tissue as culture media.—A. and L. Lumière obtain very copious growths commencing in about 36 hours on fragments of liver or spleen.

Wash the liver and spleen of an adult bovine animal or calf in distilled water, heat in the autoclave for three-quarters of an hour to shrink them and then cut into rectangular pieces; after soaking in a 6 per cent. aqueous solution of glycerin for an hour the pieces are placed in potato tubes and sterilized in the autoclave for 15 minutes. It is best to sow from a potato culture.

Gioelli uses pieces of human placenta immersed in broth, or, better, placenta-broth containing 0.5 per cent. of sodium chloride and 6 per cent. glycerin in place of liver.

8. Bile.—Calmette recommends pieces of potato soaked in a mixture of 95 parts fresh bile and 5 parts sterilized glycerin. The bile-glycerin mixture ought to be kept for 3 weeks at the temperature of the laboratory before being used. [On an ox-bile-glycerin-potato medium tubercle bacilli of the bovine type grow more rapidly and more luxuriantly than on the usual media while bacilli of the human type grow with difficulty on this medium and the avian type not at all. On the other hand bacilli of the human type will grow rapidly on an human-bile medium as will bacilli of the avian type on a fowl-bile medium; the cultivations of these two types on these media respectively are similar in appearance to cultivations of the bovine type on ox-bile (Calmette)].

9. Glycerin-broth.—Glycerin-broth, or better, glucose-glycerin-broth is a very useful medium for the growth of the tubercle bacillus. To sow a broth culture of the tubercle bacillus, raise as large a piece of growth as possible from the surface of an agar tube or other solid medium (it is even better to lift the film of growth from the water of condensation) with a fairly large platinum loop and float it very carefully on to the surface of the broth. It is advisable to transfer three or four loopsful if a large flask is to be sown.

Growth generally takes place in the form of a pellicle. After incubating for about a fortnight a whitish area appears around the piece of growth which was sown, this gradually extends and ultimately forms a thin delicate film covering the whole of the surface of the medium. The film is at first dry and fragile but becomes thicker in course of time: sometimes it remains dry and scaly and sometimes becomes greasy, moist and wrinkled. Not infrequently the film creeps up the sides of the vessel, sometimes to a height of 1 cm. Rarely no film at all is formed and in this case the growth consists of a flocculent deposit. Whatever the form of growth the broth remains quite clear.

[To obtain a successful growth on glycerin-broth requires considerable attention to details. The material used for sowing the medium must be young and actively growing—perhaps the film growing on the water at the bottom of a glycerin-potato culture gives the best results. If the culture be sown at the right moment the growth will, in the case of the human type, spread and cover the surface of the glycerin-broth in a Roux's bottle laid on its flat side in a fortnight. At other times no change whatever is visible in the material sown for weeks, then little white nodules appear which are the precursors of a growth which once it starts to spread covers the surface very rapidly. The flask must be carefully sealed.]

The tubercle bacillus can also be grown on ordinary broth containing no glycerin (Gioelli [and others]).

Pour a layer of vaseline oil about 1 mm. deep on the surface of the broth. Sterilize

and sow the medium from an agar culture or with pieces of tuberculous tissue which have been carefully crushed. The material used for sowing should float on the surface of the vaseline or between the vaseline and the broth. Should it fall to the bottom it is only necessary to shake the flask carefully and the drops of oil will float the material to the surface again. To make microscopical preparations blot up the oil from the slide with blotting paper.

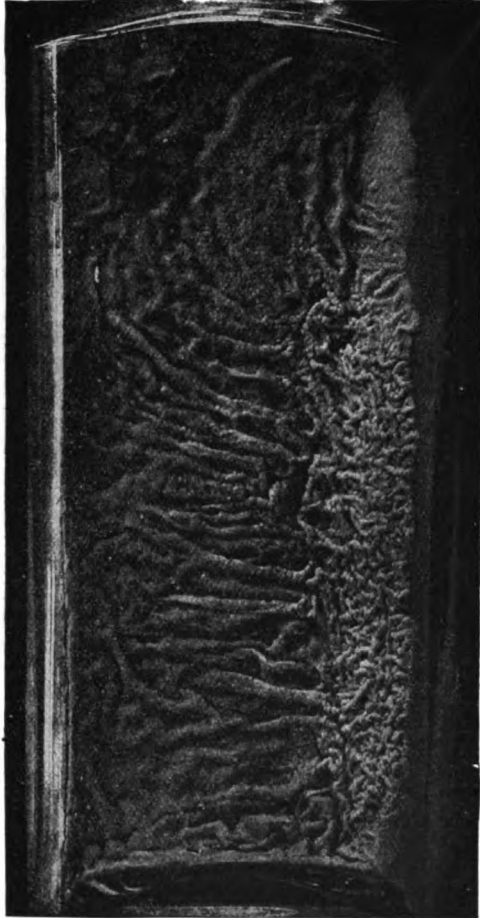

7th Generation
5 weeks old.

FIG. 209.—A culture of the human tubercle bacillus on glycerin broth. The culture was isolated from the lung of a man aged 33, who died of phthisis; it grew luxuriantly on all media containing glycerin, was virulent for chimpanzees, monkeys and guinea-pigs but had only slight virulence for calves, rabbits and horses (A. S. Griffith). (See footnote p. 316.)

10. Glycerin-fish-broth.—This medium has been recommended by Martin. The cultural characteristics are the same as on ordinary glycerin-broth.

Since the flesh of an herring and add to it one and half times its weight of water. Heat slowly and keep it boiling for three-quarters of an hour. Filter through Chardin paper several times while warm and when clear add 6 per cent. of glycerin. Neutralize if necessary. Distribute in tubes and sterilize in the autoclave.

11. Potato.—The tubercle bacillus will grow on ordinary potato but to obtain the best results it is necessary to add glycerin (Nocard).

Cut the potatoes into suitably-shaped pieces and leave them to soak in a large quantity of a 15 per cent. solution of glycerin in water for two days in the ice chest, then transfer them to a number of Roux's tubes and sterilize in the ordinary way.

On this medium growth appears about the twelfth day generally taking the form of a thick, folded, soft layer, very occasionally it is dry and wrinkled. The growth often extends in the form of a film over the liquid which has drained away into the lower part of the tube. This film will be found very useful for sowing liquid cultures.

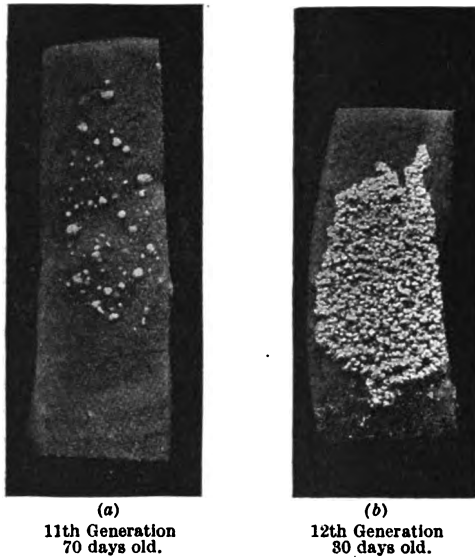

FIG. 210.—Cultures of tubercle bacilli of human origin on glycerin-potato. (a) A bovine tubercle bacillus isolated from the meninges of a child aged 2 years who died of tuberculous meningitis. The culture proved highly virulent for the calf, rabbit, guinea-pig and cat. (b) An human tubercle bacillus isolated from the sputum of a youth aged 16 years suffering from pulmonary tuberculosis. The culture grew luxuriantly on artificial media and was slightly virulent for rabbits (A. S. Griffith). (See footnote p. 316.)

Jurewitch recommends a potato broth. Leave a potato mash to macerate in its own weight of water for a day, then filter through muslin and to the filtrate add an equal volume of meat extract, 0.5 per cent. peptone (Chapoteaut), 0.5 per cent. salt and 3 per cent. glycerin: make distinctly alkaline and complete the preparation as in making ordinary broth (p. 30).

C. Differentiation of the various types of tubercle bacilli by cultural methods.

[A. S. Griffith (for the English Commission) investigating the cultural characters of mammalian bacilli, proceeds as follows. From the primary culture on egg the bacillus is transferred to pure serum until it is growing vigorously: it is then tested on the differential media. On these media human tubercle bacilli produce luxuriant growths while bovine tubercle bacilli grow much less luxuriantly. It is possible thus to determine the type of bacillus by cultural characteristics alone. The differential media are serum, agar, potato and broth, all containing glycerin. The serum, agar and broth contain 5 per

cent. glycerin and are prepared in the customary way. "The potato is cut into slices put in water and soaked for 24 hours in a 5 per cent. glycerin blue-litmus solution, which is poured off before the first sterilization; at the bottom of each tube is some absorbent cotton-wool soaked with glycerin solution which helps to keep the potato moist."

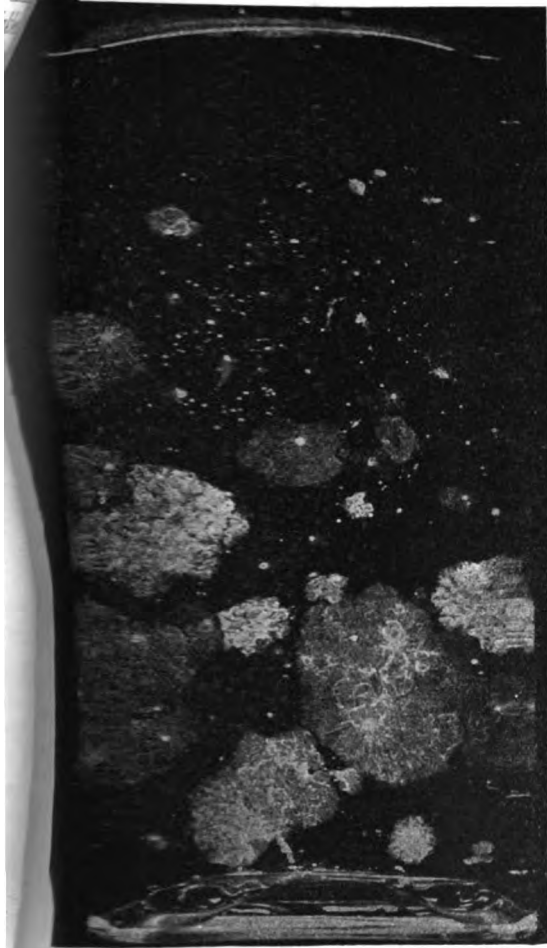

(a)
5th Generation
over 3 months old.

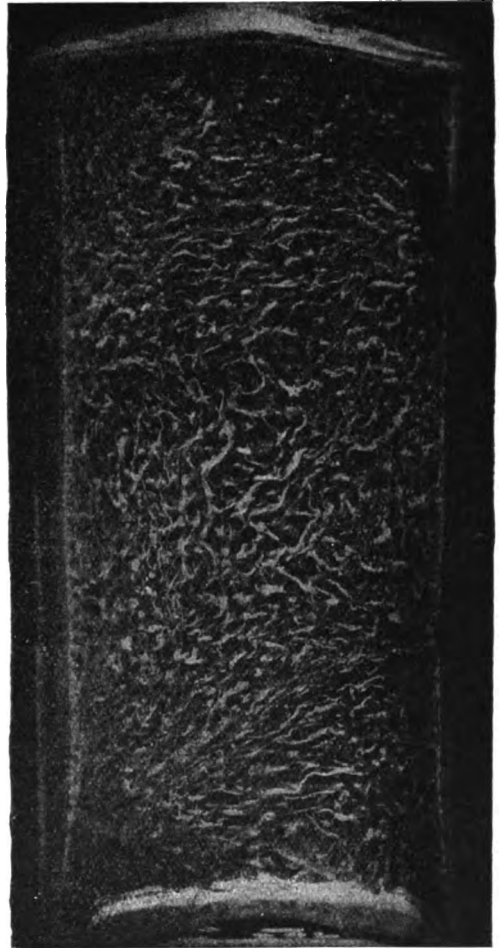

(b)
6th Generation
55 days old.

FIG. 211.—Cultures of tubercle bacilli of human origin on glycerin-gelatin.
(a) A bovine tubercle bacillus of intermediate virulence for calves and rabbits;
(b) an human tubercle bacillus slightly virulent for rabbits (A. S. Griffith).
(See footnote p. 316.)

[F. Griffith states that "it is possible to differentiate between the avian and the mammalian types of tubercle bacilli from cultural characters alone, but it is necessary in order to avoid error, that a sufficient variety of media should be used. In primary cultures on serum or serum agar the transparent colonies of avian tubercle bacilli are easily recognized. On glycerin-agar

and glycerin-potato the avian bacillus frequently forms a wrinkled or warty growth resembling a culture of human tubercle bacilli; but the characteristic difference is evident when the growth is touched with the spatula.”]

SECTION III.—BIOLOGICAL PROPERTIES.

1. Viability and virulence.

In determining the viability of the tubercle bacillus, animal inoculation, not artificial cultivation, must be the test [because sub-cultures often fail—though the culture used for sowing them may be alive—especially if the operator has not had considerable experience in dealing with cultures of the tubercle bacillus].

In cultures, the tubercle bacillus is only slightly resistant to adverse conditions and this is one of the arguments in favour of the view that it does not form spores. Exposure to 70° or 75° C. for 10 minutes kills cultures of the bacillus in liquid media.

[F. Griffith (for the English Commission) made numerous tests on bacilli grown on various media and concludes that “cultures” (of mammalian or avian tubercle bacilli) “will maintain their vitality for long periods whether kept in the incubator or at room temperature.” Avian bacilli in one culture-tube were found alive after 1067 days, and bovine bacilli similarly after 990 days: “but no distinction could be drawn between the types of bacilli tested.”]

Agar cultures [are said to] lose their virulence after a few months [but F. Griffith found that “little if any attenuation” (of the bovine bacillus) “was caused by residence on artificial media” (serum and glycerin-serum) for periods up to 1487 days. Human tubercle bacilli tested after from 2–3 years’ artificial cultivation (on serum) showed no appreciable diminution in virulence (A. S. Griffith).]

[Calmette and Guérin state that cultures on glycerin-bile-potato (p. 318) are at first increased in virulence but that repeated sub-cultivation on that medium diminishes the virulence of the bacilli for certain animal species.]

In moist sputum the bacillus is not destroyed at 75° C. but is killed in 5 minutes at a temperature of 100° C.

Cultures of the tubercle bacillus, or tubercle bacilli in sputum, retain their vitality for a long period when dried at the ordinary temperature of the air. Under these conditions, the bacilli may retain their virulence for several months (Galtier); they are not destroyed by exposure to a dry temperature of 100° C. for 2 or 3 hours and are capable of resisting a temperature of 70° C. for more than 7 hours (Welch, Grancher, Ledoux-Lebard).

The combined action of desiccation and sunlight [is said to] attenuate the virulence of the bacillus (Candler, Koch, Migneco and Ransome).

Zilgen mixed some dust with dried tuberculous sputum and exposed the mixture to the action of sunlight: under these conditions, the tubercle bacillus retained its virulence for about 140 days. According to de Thoma the virulence of the bacilli in sputum left in the patient’s room disappears after two months and a half but is retained indefinitely when the sputum is kept in the dark under the same conditions.

The virulence of tubercle bacilli in sputum exposed to the alternate action of moisture and desiccation is retained for several months (Malassez and Vignal).

The tubercle bacillus appears to maintain its vitality in water for a long time: it has been recovered from sterile water after 70 days (Chantemesse

and Widal) and after exposure to running water for 150 days (Cadéac and Malet).

Putrefaction has little effect on the tubercle bacillus. Tuberculous tissues left to decompose in water for 20 and 40 days did not lose their virulence (Galtier). Tuberculous lungs buried for 167 days have been found to be virulent (Cadéac and Malet). Schottelius found that the bacillus was virulent in tissues which had been buried for 2 years. Gärtner made the same observation after burying the tuberculous tissues for a winter.

Action of antiseptics.—In cultures, the tubercle bacillus is somewhat sensitive to the action of antiseptics. According to Yersin it is killed in 30 seconds in a 5 per cent. solution of phenol; in 5 minutes in absolute alcohol, and in 1 per cent. iodoformed ether; in 10 minutes in a 1 in 1000 solution of perchloride of mercury, and after several hours in 0.3 per cent. thymol or 0.25 per cent. salicylic acid. It resists the action of 4 per cent. boric acid for more than 12 hours.

According to Koch, the following substances readily hinder the growth of the bacillus in cultures, viz. :—the essential oils, naphthol, fuchsin, methylene blue, gentian-violet, and especially the cyanides of gold and silver. Cyanide of gold in the proportion of 1 part in 2 millions stops the growth of the bacillus.

But in tuberculous fluids and tissues the resistance of the bacillus is much greater: thus 1 in 500 salicylic acid, 1 in 1000 bromine, creosote, quinine, 1 in 1000 perchloride of mercury, and formalin vapour have no effect on the bacillus. Six per cent. carbolic acid has a doubtful influence, a 1 in 4000 solution of hydrofluoric acid (a very caustic liquid) has hardly any action (H. Martin). The numerous experiments of Vallin, Mairat, Cavalier, Coze and Siamon and others have given contradictory results.

2. Toxins.

A. Toxic properties of dead tubercle bacilli.

Koch and many other observers have found that agar cultures sterilized by heat at 100° C. are injurious to animals, and that in sufficiently large doses they lead to suppuration, cachexia and death in guinea-pigs. Dead tubercle bacilli inoculated into the blood or peritoneal cavity [of the guinea-pig] lead to the formation of true tubercles in which the presence of the dead bacilli can be demonstrated, but these lesions do not become generalized nor are they capable of being passed on to another animal. When only a small dose of dead bacilli is inoculated the lesions disappear spontaneously after a few months and the animal recovers (Cantacuzène). The more virulent the living bacilli the more toxic the dead bacilli.

[F. Griffith (English Commission) observing that the intra-venous inoculation of living mammalian tubercle bacilli in doses of 10–50 mg. caused death in about 50 per cent. of fowls, inoculated 3 fowls each with 10 mg. of bovine tubercle bacilli killed by exposure to steam at 100° C. and found in the lungs of two of them after 38 days numerous minute caseating tubercles. He concluded that the fatal infections were due to the direct toxic action of the bacilli and were not true tuberculosis.

[Similar results were obtained in fowls inoculated with dead human and avian tubercle bacilli; the latter were not more toxic for the fowl than the mammalian types.]

Hammerschlag treated dried tubercle bacilli with alcohol and ether. He obtained a product which was toxic to guinea-pigs and rabbits. The inoculated animals had convulsions and died.

Auclair extracted tubercle bacilli with ether and with chloroform. On inoculation into the trachea of a guinea-pig, these extracts produced lesions of tuberculous pneumonia.

Borrel also extracted a toxic substance from tubercle bacilli with xylol.

B. Koch's old tuberculin.

The tuberculin prepared by Koch in 1890 by a method at first kept secret is prepared in the following manner at the Pasteur Institute in Paris.

A culture of the tubercle bacillus on glycerin-broth is grown in a flask. (Bacilli of mammalian and avian origin yield the same tuberculin.) [Certain experiments recorded by the English Commission however show that tuberculin of avian origin cannot be relied on to produce a reaction in animals suffering from mammalian tuberculosis.] The growth must be on the surface of the broth. The film appears after incubating for 15–20 days at 38° C. and is complete about the 40th day.

The whole is sterilized at 110° C. for 15 minutes, then evaporated on a water bath to one-tenth its volume, and filtered through filter paper. The filtrate constitutes *crude tuberculin*.

Tuberculin is a brownish syrupy liquid with a faint, pleasant, characteristic smell. It has no definite composition but is a simple extract prepared from sterilized cultures on glycerin-broth, and contains in addition to the products secreted by the bacilli the substances originally present in the broth. The active principle has not yet been extracted. Tuberculin is very resistant to heat but is destroyed at 150° C.

Attempts have been made to purify the crude product :

(a) On the addition of 20 volumes of strong alcohol a brown precipitate is thrown down which contains the active principle and a number of other extraneous substances. Tannin, picric acid, metallic salts, ferrocyanide of potassium and acetic acid also form an albuminoid precipitate which carries down the active principle. Koch, Hunter and Klebs have failed in their attempts to purify this precipitate.

(b) Koch precipitated crude tuberculin with three volumes of 66 per cent. alcohol and obtained a flocculent precipitate which on drying formed a white powder. This constitutes *purified tuberculin*: it contains numerous extraneous substances but is a very toxic product and kills guinea-pigs when inoculated in doses of 1 mg. This is a very expensive method of preparation, as nine-tenths of the tuberculin remain in solution and are lost. Calmette precipitates crude tuberculin with 95 per cent. alcohol.

Except for Calmette's ophthalmo-reaction no advantage is to be gained by using purified tuberculin—it has the same properties as crude tuberculin.

1. The effect of Koch's old tuberculin on man and animals.

1. Healthy (non-tuberculous) subjects.—Crude tuberculin inoculated into healthy *animals* in small doses has no untoward effect except, possibly, a very slight rise of temperature. Guinea-pigs can be inoculated with 2 c.c. of tuberculin without harm. Rabbits stand an injection of 5 c.c. of crude tuberculin very well, there is a slight rise of temperature and a transitory loss of weight but the animal quickly recovers. Cattle and dogs do not react to doses of 10 c.c.

In *man* an injection of 0.25 c.c. into a healthy adult leads to somewhat severe symptoms: rigors, diarrhoea and vomiting with a rise of temperature to perhaps 39° C. (Koch). As small a dose as 0.01 c.c. may produce a slight rise of temperature. Man is therefore about 1000 to 1500 times as sensitive to tuberculin as the guinea-pig.

The toxicity of tuberculin can be considerably diminished by adding to it a calculated amount of anti-tuberculous serum (*vide infra*), the toxicity of the mixture is then due to *toxones*. Tuberculin neutralized in this way gives no better results in

the treatment of tuberculosis than tuberculin or anti-tuberculous serum given alone. It [is said to] assist the production of the disease experimentally (Arloing and Descos).

2. In persons infected with tuberculosis and in tuberculous animals, the inoculation of small doses of tuberculin gives rise to a marked reaction and severe symptoms which may terminate fatally.

A dose of 0.5 c.c. of tuberculin rapidly kills a guinea-pig infected with tuberculosis 5 or 6 weeks before; there is a sudden rise of temperature followed by a gradual fall and the animal dies in a state of coma. *Post mortem* there is intense congestion around the tuberculous foci and the internal organs are red, congested and ecchymosed.

In tuberculous cattle the inoculation of quantities of 0.30–0.40 c.c. causes a rise of temperature about 6 hours afterwards from 38°–39° C. (the normal bovine temperature) to 40°–41° C. The animal recovers its normal condition in a few days. Large doses of tuberculin are liable to kill the animal.

Persons suffering from tuberculosis react very sharply indeed to the inoculation of tuberculin: 0.25 c.c. invariably leads to a fatal result.

The so-called curative doses employed by Koch were 0.003–0.004 c.c. Following the injection the patient had rigors, and a rise of temperature to 41° C. The inoculation was frequently followed by coughing, nausea, vomiting, jaundice, etc. Around cutaneous tuberculous lesions there was an intense inflammatory reaction. According to Koch these symptoms ought to last 12–15 hours and then give way to a progressive improvement of the pre-existing lesions. Nothing would be gained here by recalling the disasters which followed the use of tuberculin. The treatment of tuberculosis with tuberculin has recently been revived especially in Germany as the result of the work of Denys, Sahli, and Beraneck. The doses used are much smaller than those used by Koch. The results obtained by this method of treatment have not shown it to be of any great value.

Intra-cerebral inoculation.—A guinea-pig weighing 500 grams which will stand the inoculation of 1 c.c. sub-cutaneously dies when inoculated in the brain with 3–4 mg. of the same tuberculin (von Lingelshelm, Borrel).

A guinea-pig inoculated 12 days previously with tuberculous material succumbs to the intra-cerebral inoculation of 0.1 mg. of tuberculin. The inoculation of 0.001 mg. of tuberculin into the brain of a guinea-pig which has been infected with tuberculosis 6 weeks previously produces symptoms of hiccough, convulsions, muscular twitchings, etc. and the animal very soon dies. These facts afford an explanation of the symptoms of tuberculous meningitis—the only form of tuberculosis in which the action of the poison on the nerve cells can be demonstrated (Borrel).

The toxins of tetanus, plague, etc., are no more toxic in the brain of tuberculous guinea-pigs than in the brain of healthy animals. *Mallein* alone acts like tuberculin: unconcentrated mallein which is harmless to tuberculous guinea-pigs when inoculated sub-cutaneously in doses of 3–4 c.c. leads to a fatal result when inoculated intracerebrally in doses of 0.01 or 0.001 c.c. (Borrel).

2. Koch's old tuberculin in the diagnosis of tuberculosis.

A. In Cattle.—Nocard showed that tuberculin is a valuable reagent in the diagnosis of tuberculosis in cattle. In bovine animals the early diagnosis of tuberculosis is clinically impossible in the majority of cases, but it is very important from the point of view of prophylaxis that the disease should be recognized in these animals in its very earliest stages.

Tuberculous cattle, however small the lesions may be, react to the inoculation of 0.30–0.40 c.c. of crude tuberculin. The temperature rises 1.5°–3° C. Animals free from tuberculosis do not react under similar conditions.

The method of diagnosis is as follows.

1. The animal to be tested is kept quiet and its temperature taken in the rectum the day before as well as on the day on which it is to be tested.
2. Dilute the tuberculin.

| | |
|--|--------|
| Crude tuberculin, - - - - - | 1 c.c. |
| Boiled water containing 0.5 per cent. carbolic acid, - - - - - | 9 „ |

This solution will not keep and should be newly prepared for each experiment.

3. With the usual aseptic precautions inoculate the animal sub-cutaneously in the neck with 3-4 c.c., according to its size, of the diluted tuberculin.

4. Take the temperature 12 hours after inoculation and again 16 hours, 20 hours and 24 hours after. [Twelve hours is too late. The temperature should be taken 6, 9, 12, 15, 18, 24 and finally 36 hours after inoculation.]

Any animal which during that period shows a rise of temperature of 1.4° C. ought to be regarded as tuberculous. Animals which suffer a minimal rise of temperature (0.5°-0.8° C.) are healthy. When the rise of temperature is between 0.8° and 1.4° C. there is a suspicion of tuberculosis and the animal should be tested again a month later.

Note.—The tuberculin reaction though of great diagnostic value, is not absolutely reliable. In severely infected animals there may be no reaction. On the other hand, a rise of temperature of 1° C. is not sufficient upon which to base a diagnosis. A few cattle which showed a rise of 2° C. were subsequently found to be free from tuberculosis (Arloing, Rodet and Courmont). Infection of the lung with echinococcus is particularly likely to give the temperature reaction in cattle.

B. In man.—Tuberculin has been used in the diagnosis of doubtful cases of the disease in man.

The inoculation of tuberculin is always attended with a certain amount of danger and very great care must be exercised in its use. In any case the dose injected must never exceed 0.002 gram, and the following solution should be used.

| | |
|--|--------|
| Crude tuberculin, - - - - - | 4 c.c. |
| Boiled water containing 0.5 per cent. carbolic acid, - - - - - | 996 „ |

One c.c. of this solution contains 0.004 gram of crude tuberculin and not more than a fraction of 1 c.c. should be inoculated. The temperature is taken for 2 or 3 days before the inoculation and every 8 hours for 36 hours afterwards. The part suspected to be infected must be carefully watched, the local reaction being of the greatest importance from the point of view of diagnosis. In patients who have suffered from tuberculosis for a very long time, small doses of tuberculin often produce no temperature reaction (Freyth).

As to the amount of tuberculin to be inoculated to obtain a reaction observers differ. There are three methods of using tuberculin for purposes of diagnosis.

1. **Single inoculation.**—A single dose of 0.5 c.c. of the above solution (0.002 gram of crude tuberculin) is inoculated. This method is not free from danger.

2. **Inoculation of increasing doses.**—German observers, among whom tuberculin is largely used for the diagnosis of tuberculosis in man, do not hesitate gradually to increase the amount of tuberculin until the dose inoculated is very considerable. Generally a dose of 0.5 mg. of crude tuberculin is inoculated deeply into a muscle in the first instance and then gradually increasing doses of 1, 3, 6 and even 10 or 20 mg. every 3 or 4 days until the specific reaction is obtained.

In soldiers in apparently good health, Franz found that tuberculin in doses of 1-3 mg. set up a reaction in about 64 per cent. of the men and when the dose was increased to 10 mg. 96 per cent. reacted.

By gradually increasing the dose of tuberculin a non-specific reaction can [it is said] be produced in healthy persons. [But] in any case it would be most unwise to inoculate such dangerous doses.

3. Repeated inoculation of small doses.—Many observers advise that four or five small doses, 0·1–0·2 mg., should be given at intervals of 3 or 4 days. This is the least dangerous method and the one to be adopted to avoid the untoward results which so frequently follow the inoculation of tuberculin. Repeated small doses lead to a state of hypersensibility¹ and the diagnosis can be made without running the risks attendant upon the use of increasing doses. About 95 out of every 100 tuberculous subjects react to the third or fourth inoculation.

When several successive inoculations of tuberculin are made signs of inflammation appear after each fresh injection around the sites of the former inoculations. The lesions produced are similar to those set up [in the early stages of an infection] by the tubercle bacillus (Klingmueller).

4. Cuti-reaction.—Von Pirquet has shown that when tuberculin is inoculated through scratches on the skin of a tuberculous child, in nearly every case (save in acute miliary tuberculosis and tuberculous meningitis) a small papule—occasionally a vesicle—appears lasting about 8 days; at first it is bright red but subsequently becomes darker in colour. This reaction is of great diagnostic value in the early years of life. Older children often, and adults nearly always, react even when tuberculosis cannot be demonstrated clinically (which calls to mind the fact that *post mortem* nearly all adults show lesions of tuberculosis). In cachectic individuals the reaction often fails.

To effect the reaction make four small scarifications, not deep enough to draw blood, on the skin of the outer and upper part of the arm and cover the lower three with a small drop of diluted tuberculin (p. 326). (Tubes containing tuberculin for the cuti-reaction can be purchased at the shops.) The vaccination marks should be about 2 cm. apart. The upper mark which has not been treated with tuberculin serves as a control. When the reaction is positive, a swelling begins to appear about 48 hours after inoculation.

H. Vallée has shown that von Pirquet's cuti-reaction is of value as a diagnostic test for tuberculosis in the lower animals (cattle, horses and guinea-pigs). While healthy animals do not react, tuberculous animals show, about 36–48 hours after the inoculation, an oedematous infiltration of the vaccination mark with a painful grey-red swelling. The reaction occurs in healthy animals which have been previously treated with a subcutaneous inoculation of tuberculin (this confirms Klingmueller's phenomenon described above).

5. Intra-dermo reaction.—This method of diagnosis is recommended by Martoux but does not seem to offer any advantages over the cuti-reaction. The reaction consists in inoculating a drop of tuberculin into the skin with a fine needle. Calmette advises a 1 in 5000 solution of dry tuberculin precipitated with alcohol. In persons affected with tuberculosis a red, or bright pink, oedematous infiltration surrounded by a more or less extensive area of erythema is seen about 24 hours after the inoculation.

6. Ophthalmo-reaction.—Calmette and Wolff-Eisner have shown that the instillation of a small amount of tuberculin into the eye produces in persons affected with tuberculosis a very marked congestion of the palpebral conjunctiva. The test is easily performed and is very delicate and, provided it is not used when any lesion of the eye is present nor in old people, is quite free from danger.

[¹Repeated injections of large doses sometimes diminish the reacting power of the tissues in animals.]

Calmette says that crude tuberculin should never be used for the ophthalmoreaction because the glycerin present in solution acts as an irritant. He uses a recently made 1 per cent. solution of dried tuberculin (twice precipitated with 95 per cent. alcohol) in distilled water. One drop of the tuberculin is instilled into one eye. Three to five hours later, in all tuberculous persons, there is congestion of the inner end of the palpebral conjunctiva, and more or less œdema and swelling of the caruncle which is covered with a slight fibrinous exudate. Lachrymation occurs and there is a little discomfort but no pain. The reaction reaches its maximum in 6–10 hours, and after 18 hours in children and 24 hours in the adult the signs subside and disappear.

In persons not infected with tuberculosis instillation occasionally produces a little redness but there is never lachrymation nor any fibrinous exudate.

The advantage of the ophthalmoreaction is, according to Calmette, that it indicates the presence of active lesions only and as a means of diagnosis is of more value than the cuti-reaction. A negative reaction is sufficient to exclude a tuberculous infection except in tuberculous persons suffering from cachexia who have lost the power of reacting. Persons who have recovered from a tuberculous infection give a negative reaction. [Other observers confirm Calmette, finding that] with rare exceptions (some cases of enteric fever, for instance,) a positive reaction indicates an active tuberculous infection.

[7. **Percutaneous reaction.**—Moro rubs a lanolin ointment containing 50 per cent. of Koch's old tuberculin into the skin of the chest or abdomen over an area of about three square inches. From 1–2 days after the application numerous small red papules appear on the anointed surface in tuberculous individuals. The eruption is transitory and the reaction quite painless. The results are very comparable with those given by von Pirquet's method.]

C. Tuberculins TA, TO, and TR.

Koch investigated a number of complex products derived in various ways from cultures of the tubercle bacillus. These are known as tuberculin TA, tuberculin TO, and tuberculin TR.

1. **Tuberculin TA** (*alkaline tuberculin*).—Tubercle bacilli separated by filtration from a virulent culture are treated with a 10 per cent. solution of soda and after 3 days' exposure at room temperature the bacilli are killed and the liquid can be filtered through paper. After neutralization the filtrate is clear, slightly yellowish and contains numerous dead bacilli. Inoculation of the filtrate produces results similar to, but rather more persistent than, ordinary tuberculin, and often leads to the formation of an abscess containing sterile pus. After filtering through a bougie TA gives results identical with ordinary tuberculin.

2. **Tuberculin TO and tuberculin TR.**—Bacilli from a young, virulent culture are dried *in vacuo* in the dark and then rubbed up in an agate mortar for a long time. This is a dangerous proceeding and should be carried out with the utmost care. The powder so obtained is mixed with distilled water and the emulsion centrifuged for 40 or 45 minutes (4000 revolutions a minute). Two layers are formed; the upper (*obere*), fluid and opalescent and containing no bacilli, is decanted off and forms tuberculin TO.

The muddy lower layer is dried, rubbed up again, mixed with distilled water and centrifuged. The residue from the centrifuging is treated in the same way and the operation is repeated several times. Finally the liquids poured off after each centrifuging are mixed together and form tuberculin TR [*Rückstand*].

Tuberculin TO is very different from tuberculin TR.

Tuberculin TO is not altered by the addition of 50 per cent. of glycerin : its properties are almost identical with those of ordinary tuberculin and its immunizing properties are nil or very little marked.

Tuberculin TR gives a flocculent, white precipitate on the addition of 50 per cent. of glycerin. Its characters are unaltered by the addition of 20 per cent. of glycerin which, on the other hand, preserves it.

According to Koch tuberculin TR has distinct immunizing properties. Repeated inoculation of small doses into the human subject confers an immunity against ordinary tuberculin and TO, as well as against itself. These statements have not been confirmed (Bounhiol); tuberculin TR, whatever Koch may have said, appears to have no power of arresting tuberculosis. In tuberculous persons, a reaction similar to that produced by ordinary tuberculin occurs but very inconstantly. It appears to be less dangerous than ordinary tuberculin, but, on account of the irregularity of its effects, it cannot be used for purposes of diagnosis.

D. Maragliano's tuberculin.

This is a watery tuberculin obtained by maceration of tubercle bacilli. Recover the bacilli from a glycerin-broth culture, add to them a volume of distilled water equal to the volume of the culture fluid and heat to a temperature of 95°–100° C. for 50 hours or so. Then evaporate on a water bath to one-tenth its original volume and filter through filter paper.

The filtrate has the same properties as Koch's old tuberculin and is said to possess vaccinating properties. Doses of 5 c.c. are fatal to healthy guinea-pigs weighing 500 grams. Tuberculous guinea-pigs succumb to the inoculation of 0.10–0.20 c.c. of this tuberculin.

When precipitated with alcohol, Maragliano's tuberculin yields a powder which kills guinea-pigs in doses equivalent to $\frac{1}{25,000}$ th of their weight and rabbits in amounts corresponding to $\frac{1}{33,000}$ th of their weight.

E. Toxalbumin.

The different toxic products which have just been studied are contained within the bacilli—endotoxins—and to extract them the bacilli have to be killed by heat or destroyed by trituration.

Maragliano, Bezançon and Gouger have shown that the tubercle bacillus produces a diffusible toxin which passes into the medium in which the bacilli are growing. This toxin is of the nature of a toxalbumin : it is destroyed by heating it to 100° C. and by prolonged exposure to light. It is prepared by filtering a glycerin-broth culture through porcelain and concentrating the filtrate to one-tenth its original volume *in vacuo* at 55° C.

The product differs absolutely from the tuberculins : it is more toxic than the latter and inoculated into animals it never produces a rise of temperature even in non-fatal doses : in fatal doses the animals die with a sub-normal temperature.

Denys uses a porcelain-filtered glycerin-broth culture of the tubercle bacillus in the treatment of tuberculosis.

Beraneck prepares a *toxin-broth* by growing the tubercle bacillus in a maceration of veal made in the cold to which 0.5 per cent. salt and 5 per cent. glycerin are added before sterilization. By the time that the surface is covered with a pellicle, the medium, originally alkaline, has become acid. It is then made alkaline with lime water, filtered through a Chamberland bougie, and the filtrate evaporated *in vacuo* to one-tenth its original volume.

Beraneck recommends for the treatment of tuberculosis the use of this toxin broth diluted with an equal volume of an acid extract of the bodies of bacilli containing

endotoxin. This extract, or *acido-toxin*, is made by macerating tubercle bacilli in a 10 per cent. aqueous solution of ortho-phosphoric acid for 2 hours at 60° C., neutralizing the product, filtering and diluting nineteen times with water (1 in 20 solution of endotoxin).

3. Vaccination.

A. Laboratory animals.

(i) Grancher and Martin.—Rabbits are inoculated with avian tubercle bacilli which have been grown on artificial media for prolonged periods. By using successively less and less attenuated cultures they have succeeded in a few cases in producing a certain degree of immunity in the animals.

(ii) Héricourt and Richet sterilize cultures of avian bacilli by heating them several times to 80° C. and then inoculate them into rabbits in doses of 10–20 c.c. This method has enabled them to confer immunity on a few animals.

(iii) Courmont and Dor filter glycerin-broth cultures and inoculate the filtrate into rabbits at the same time that or before they inoculate a tuberculous virus. With bacilli of *avian* origin they succeeded in producing immunity twice in four experiments but they failed with the bacillus of human origin.

(iv) In the foregoing experiments, attempts to vaccinate guinea-pigs had failed. E. Levy immunizes guinea-pigs by inoculating them with a tubercle bacillus [which he states to have been] attenuated by being kept in glycerin (p. 322).

Two guinea-pigs are inoculated, one into the peritoneal cavity, the other subcutaneously, with a slightly opalescent emulsion of tubercle bacilli which has been kept in 80 per cent. glycerin for 6 days in the incubator at 37° C. When they have recovered from the first inoculation they are again inoculated on successive occasions with bacilli which have been kept in glycerin for 4, 3 and 2 days. When they have completely recovered they, as well as two control animals, are inoculated with a tubercle bacillus of standard virulence. All the animals develop an abscess at the site of inoculation but at the end of about 4 weeks the lesion in the case of the vaccinated guinea-pigs has healed while in the controls the disease has spread to the glands. Towards the end of the third month the controls are suffering from a generalized tuberculosis (liver, spleen and lungs) while the most minute search fails to reveal any trace of tuberculosis in the vaccinated animals killed at the same time.

B. Cattle.

(i) Von Behring succeeded in vaccinating young bovine animals (healthy calves under one year old) by inoculating them intra-venously with living attenuated bacilli of human origin, non-virulent for cattle (bovo-vaccin).

The bacillus used by von Behring in his experiments was a human tubercle bacillus which had been in artificial culture for 8 years and had lost much of its original virulence (*vide* p. 322, attenuation of tubercle bacilli). A five-week-old culture of this bacillus on glycerin-serum could be inoculated with impunity into the veins of a calf in doses of 0.005 gram. A first injection of 0.001 gram provoked no reaction and was followed by several other inoculations with increasing doses at intervals of several weeks. Animals treated in this way were finally able to resist doses of bacilli of bovine type which were fatal to the control animals.

Behring has now modified his original procedure. He first inoculates, intra-venously, 0.004 gram of a glycerin-agar culture of a bacillus of human origin completely dried *in vacuo* at the ordinary temperature (the bacilli are ground up in a mortar and emulsified in 4 c.c. of a 1 per cent. saline solution). A month later the animal is similarly inoculated with 0.01–0.02 gram of the same culture.

Animals treated in this way and exposed to contagion or inoculated with a virulent bacillus of bovine origin never develop any tuberculous lesion. And, further, when tested with tuberculin a year after immunization they always fail to react.

With other observers this method of vaccination has always given favourable results, but complete immunity has not been attained.

Vallée and Rossignol undertook a series of control experiments on twenty calves each about 5 months old which had not reacted to tuberculin. These animals were first inoculated in the jugular vein with 4 mg. of dried tubercle bacilli (bovo-vaccin of von Behring) and 3 months later with 20 mg. of similar bacilli. They were tested by intra-venous and sub-cutaneous inoculation and by being kept in contact with animals suffering from open tuberculous lesions. From these experiments, Vallée and Rossignol conclude that von Behring's method of vaccination is harmless to animals protected from sources of accidental infection during the period of immunization and for 6 weeks afterwards: that the vaccination confers considerable but not absolute powers of resistance to the most severe methods of infection and that the vaccinated animals are able to resist for some months spontaneous infection which might have been expected to arise from prolonged contact with infected animals.

Von Behring's method of vaccination should be performed on animals less than 3 months old. In calves more than a year old the vaccinating process occasionally sets up a violent reaction and is dangerous to life. The severity of this reaction seems to depend upon an anterior infection with tuberculosis and it is well known that in cattle the younger the animal the more rare the disease. The resulting immunity is especially noticeable when the animals are tested by intra-venous inoculation but is only effective for a few months when tested by feeding the animals with infected food stuffs or keeping them in contact with cattle suffering from open tuberculous lesions.

(ii) With a view to getting more constant results and a more efficient method of vaccination some observers have experimented with living and virulent bacilli of the human type. Experience has shown that the immunity produced in cattle by the inoculation of living cultures runs parallel with the virulence of the tubercle bacillus used in the experiments, the higher the virulence of the bacillus the greater the degree of immunity produced.

[A. S. Griffith and F. Griffith (English Commission) investigated the production of immunity in calves by the inoculation of living tubercle bacilli. Twelve calves were inoculated sub-cutaneously or intra-venously, ten with human and two with bovine tubercle bacilli and were subsequently tested as to their resistance by the sub-cutaneous inoculation of a large dose (50 mg.) of bovine tubercle bacilli. Nine of the calves "had their resistance so far increased that 50 mg. of bovine tubercle bacilli were unable to set up in them progressive tuberculosis." Of the remaining three two died of acute tuberculosis and the third when killed showed general tuberculosis but in a less severe degree than in any of the four control animals. Thus "by the inoculation of large doses of human or small doses of bovine tubercle bacilli, the resistance of a calf can be raised sufficiently to protect it against the inoculation of a dose of bovine tubercle bacilli capable of setting up a severe and fatal tuberculosis in a calf not so protected"; but "this degree of resistance is not always produced." There was no evidence to show that vaccination with bovine tubercle bacilli produced a higher degree of immunity than vaccination with human tubercle bacilli.]

Bacilli killed by heat are devoid of vaccinating properties.

But vaccination with an active virus is not free from danger; inoculation of living bacilli of the human type may [it is said] set up latent lesions which can be re-awakened and constitute a permanent menace of re-infection; and finally, it is a danger to the consumer of the meat [and milk].

[A. S. Griffith (English Commission) found that if milking cows are "inoculated sub-cutaneously or intra-venously with tubercle bacilli of relatively slight virulence such bacilli quickly appear in their milk and may continue

to be eliminated therein for long periods." It is obvious from these experiments that the vaccination of milch cows with living bacilli is undesirable. Other experiments by this observer also seem to indicate that this method of vaccination is not free from danger. In "seven out of eleven heifers (ages 6-10 months) tubercle bacilli of various types which had been inoculated in large doses into the sub-cutaneous tissues had found their way into the milk sinuses of the undeveloped mamma" and in four cases at least appeared to have undergone multiplication since their arrival there. There is therefore reasonable probability that the first milk of some of these animals would have contained living tubercle bacilli.

[Immunization with living tubercle bacilli, whether human or bovine, is therefore not free from risk.]

Thomassen injected 2-3 cg. of fresh tubercle bacilli from an human source grown on glycerin-potato into the jugular vein of calves; as a rule, the animals were resistant to a subsequent inoculation of bacilli of bovine origin but the animals might succumb to the vaccinating inoculation and in those that recovered it was possible that the disease might subsequently recur. Thomassen preferred to give increasing doses (1 mg. at the first inoculation, 10 mg. a month later and finally 20 mg.). The results were good but not constant. It was not uncommon to find that in vaccinated animals which had failed to react to the test inoculation, the bronchial glands, though normal in appearance when the animal was killed a few weeks later, produced tuberculosis on inoculation into guinea-pigs. [Cobbett (for the English Commission) found that human tubercle bacilli inoculated into calves remained alive for prolonged periods, in lesions so minute as to be hardly visible.]

Hutyra had good results with a similar method (inoculation of a recent potato culture of tubercle bacilli of human origin).

Baumgarten obtained very favourable results by simple *sub-cutaneous* inoculation of human tubercle bacilli of standard virulence. According to the author there was a non-specific, local, inflammatory lesion.

(iii) Koch and others immunized calves by inoculating them with an attenuated bacillus of bovine origin. The inoculations were made into the jugular vein, 10 mg. on the first occasion and 25 mg. 3 weeks later.

It did not appear to be a true vaccination but a more or less brief increase of resistance to the action of the bovine type of bacillus. An heifer which had been vaccinated did not react to the test inoculation and remained in apparent good health but died 14 months later while suckling a calf. Lactation would appear to re-awaken a latent infection (Peperé).

[Pregnancy appears to render the sex-organs peculiarly susceptible to tuberculosis. Cobbett (for the English Commission) records that three out of six heifers inoculated when pregnant with bovine tubercle bacilli developed tuberculosis of the uterus. In none of the three was the generalized disease very acute, and in one (in which the mammary gland also was affected) there was very little tuberculosis elsewhere. The non-pregnant uterus, he continues, has never been found affected in calves suffering from general tuberculosis however severe.]

Klemperer endeavoured to treat persons suffering from tuberculosis by inoculating them with tubercle bacilli of bovine type. He is said to have noticed improvement in the condition of the patients but his experiments are not conclusive. Similarly the inoculation of bacilli of the human type into tuberculous cows appeared to have no curative action.

(iv) Vallée succeeded in vaccinating cattle against the effects of the injection of tuberculin and in conferring some degree of immunity against living cultures by inoculating them intra-venously with dead tubercle bacilli from which the fat had been extracted.

The bacilli were rapidly washed in distilled water, drained and dried for several days *in vacuo* over sulphuric acid, then placed in a flat-bottomed flask with pure petroleum ether and glass balls. The flask was placed in a shaking apparatus and the contents shaken for 60 hours.

The bacilli had then lost their acid-fast properties. The emulsion was dried in a desiccator to remove all traces of the ether from the bodies of the bacilli.

Tubercle bacilli treated in this manner behave like a very powerful tuberculin. They kill guinea-pigs in doses of 70 mg. When inoculated several times in doses of from 25–100 mg. into the jugular vein they [are said to] render young calves to a certain degree immune to the bacillus of bovine type. Horses and cattle rendered immune to the inoculation of these bacilli cease to react to the intra-venous inoculation of the various tuberculins.

(v) Animals vaccinated by inoculating them intra-venously show themselves very slightly immune to intestinal infection—a mode of infection particularly common in nature. Behring, Calmette and Guérin, Roux and Vallée have tried to immunize animals by feeding them with tubercle bacilli and have met with some success. The method is only practicable in the case of young cattle and the resulting immunity is particularly efficient against intestinal infection. Although the immunity is only relative the method gives better results than intra-venous inoculation: the animals remain uninfected for a year when kept with cattle suffering from open lesions.

Two young calves were fed at intervals of 45 days with 5 and 25 grams of tubercle bacilli of the human type. Four months later failing to react to tuberculin they were fed with 0.05 gram of freshly isolated bacilli of the bovine type: 32 days later they failed to react to tuberculin while two controls reacted in the ordinary way.

Vallée also immunized a young calf by feeding it, through an oesophageal sound, on two occasions, when it was 2 days and 90 days old respectively, with 20 cg. of a well-made emulsion of a tubercle bacillus of equine origin which was only slightly virulent for guinea-pigs.

Roux and Vallée, Calmette and Guérin have shown that small doses of virulent bacilli of the bovine type when introduced into the alimentary canal of the calf are absorbed into the mesenteric glands and give rise to a substantial immunity in the animal. A certain amount of risk attaches to this method of immunization (Vallée).

(vi) For the purpose of producing immunity Arloing uses homogeneous cultures of bacilli of the human type (*vide infra*) which have lost much of their capacity of producing tubercles; by submitting them to gradually increasing temperatures Arloing was able to grow them at 43°–44° C. These cultures vaccinate calves and appear to act as a true pasteurian vaccine.

C. Vaccination with a virus of chelonian origin.

Friedmann showed that a bacillus which he had recovered from a tortoise (p. 297) produced when inoculated beneath the skin of a guinea-pig a typical localized tuberculous focus which soon completely healed while the animal never showed any sign of generalized tuberculosis. Further, guinea-pigs treated in this way resisted the inoculation of a dose of bacilli of the human type which killed control animals in 4–6 weeks.

In vaccinated guinea-pigs the inoculation of a virus of human origin gave rise to a transitory swelling of the glands and to a caseo-purulent tuberculous focus which healed and left no trace of the injury: when the animals were killed about 3 months later no lesion was found: it is true that small whitish points were seen in the internal organs but these were in no way suggestive of true tubercles and similar lesions are found in animals immune to tuberculosis or vaccinated in various ways against the disease (Koch, von Behring, Neufeld, Thomassen, and others).

The method is available for the immunization of bovine animals against tubercle bacilli of the bovine type. Intra-venous inoculation of calves with a bacillus of chelonian origin [is said to] produce a lasting immunity against bacilli of the bovine type. The method might also be applicable to the treatment of animals suffering from tuberculosis. Libbertz and Ruppel have not been able to confirm these results.

Conversely, Friedmann succeeded in vaccinating tortoises against bacilli of chelonian origin by inoculating them with a virus of the human type.

Möeller, carrying out similar researches, succeeded in infecting blind-worms with human tubercle bacilli and for the purpose used as a vaccine a bacillus of the human type which had been passed through a series of blind-worms. Möeller did not hesitate to practise his method of vaccination on himself. On three separate occasions he inoculated himself intra-venously with a culture of the bacillus from the lesions in the blind-worm and a month after his last vaccination he was inoculated intra-venously with an emulsion of virulent bacilli of the human type which was rapidly fatal to guinea-pigs. This inoculation produced merely a transitory loss of weight without any disturbance of health a year afterwards.

4. Serum therapy.

Attempts at serum therapy in tuberculosis have up till the present given no conclusive results.

(i) Richet and Héricourt by inoculating rabbits with dog-serum before infecting them with tubercle bacilli have been able to delay the course of infection in some of the inoculated animals. Unfortunately, the success of the experiments was very relative and inconstant. Bertin and Picq, experimenting with inoculations of goat serum, obtained similar results.

(ii) Von Behring and Niemann also failed with the serum of animals treated with tuberculin.

(iii) Bernheim tried the blood of animals inoculated with filtered but unheated cultures of tubercle bacilli. His experiments were unsuccessful. The results obtained by Babès and Broca were no more encouraging.

(iv) Maragliano obtained a serum of obvious *antitoxic* properties. He injected animals with increasing doses of a mixture of three parts of ordinary tuberculin and one part of an extract of porcelain-filtered unheated cultures (p. 329). The treatment was continued for 6 months and when 3 weeks had elapsed since the last inoculation the animals were bled. *In vitro*, the serum destroyed the toxic properties of tuberculin and protected guinea-pigs against this poison: 1 c.c. of the serum protected a healthy guinea-pig against a fatal dose of tuberculin: 2-4 c.c. rendered a tuberculous guinea-pig capable of standing without harm a dose of tuberculin which in the ordinary way would have killed it in a few hours. Experiments to determine whether the serum protected healthy animals against infection with the tubercle bacillus were not conclusive.

(v) Marmorek for the treatment of tuberculosis suggests the use of a serum obtained by inoculating horses with a special toxin (a filtered culture of bacilli grown on a leucotoxic calf serum containing glycerin-liver-broth).

(vi) Lannelongue, and Achard and Gaillard found that the serum of asses possessed therapeutic properties after the animals had been treated by inoculation with a toxin extracted from the bacilli by heating in water at 120° C., precipitating with acetic acid and redissolving the precipitate in sodium carbonate.

(vii) Baumgarten and Hegler after vaccinating a bovine animal with bacilli of the human type were able to inoculate bacilli of the bovine type

on five successive occasions without producing any appreciable reaction. The tuberculin test was negative and the serum of this animal inoculated prophylactically into a calf (82 c.c. sub-cutaneously in a fortnight) protected the latter against a sub-cutaneous inoculation of bacilli of the bovine type while two controls similarly inoculated with the test culture became infected. The passively immunized calf when killed 6 months afterwards showed no tuberculous lesion. As a curative agent this serum is without effect.

(viii) Vallée treats horses by inoculating them first with progressively increasing doses of bacilli of equine origin then with bacilli of human origin. The serum of such animals exhibits no agglutinating properties but contains immune bodies (*sensibilisatrices*) and has distinct therapeutic properties in the treatment of bovine tuberculosis.

(ix) The serum of bovine animals, guinea-pigs and pigs vaccinated by Friedmann with the chelonian bacillus has proved itself in the case of the guinea-pig to possess undoubted prophylactic properties. While control guinea-pigs died of generalized tuberculosis, the treated guinea-pigs killed at the same time only showed insignificant lesions.

5. Agglutination.

1. The serum diagnosis of tuberculosis with ordinary cultures, consisting as they do of bacilli massed together to form films or scales, is quite impossible. Arloing and Courmont have described a method of obtaining *homogeneous cultures* which are quite suitable for the demonstration of the phenomena of agglutination.

Arloing's homogeneous cultures are obtained from luxuriant, greasy-looking, growths on glycerin-potato. After being sub-cultivated a few times on glycerin-potato the tubercle bacillus is sown in cylindrical flasks with a flat base half filled with a 1 per cent. peptone beef broth containing 6 per cent. glycerin. The cultures are incubated at 38°-39° C. and shaken daily. It is necessary to sub-cultivate several times in order to get a copious growth.

The cultures should be used when about 10 days old: later they are thick and too rich in bacilli and are only partially agglutinated by the specific serum.

Cultures sown in this way are distinctly cloudy after a few days, and when shaken have a watered silk appearance; the cloudiness subsequently increases and becomes uniform, and after 2 or 3 weeks the growth is more or less milky. A drop of the culture examined unstained shows small, isolated rods occasionally slightly motile. The bacilli stain by Ziehl's method (except in rare cases recorded by Arloing and by Ferran). On inoculation into animals they behave like tubercle bacilli of a very low degree of virulence.

Ten-day-old cultures suitable for agglutination can be kept for about a fortnight in the ice-chest or by adding a little formalin (3-4 per cent.) to them; the agglutinability diminishes after a few weeks.

To obtain and to keep an agglutinable culture more easily Arloing and Courmont now advise the use of old cultures which must be diluted as required. The culture is left in the incubator for 30 or 40 days and can be used at once or kept in the ice-chest for about 1 month. When required for use the culture is diluted with sterile normal saline solution until it gives a milky, slightly opaque fluid like a solution of glycogen (about 1 in 50).

When a culture is used for purposes of serum diagnosis a control should always be done with a standard serum of which the agglutinating property is known beforehand (the serum of an experimentally infected animal, or a tuberculous pleural exudate, for example).

Homogeneous cultures are agglutinated by the serum of animals which have been inoculated with tuberculin or living bacilli and by the serum of most tuberculous human subjects (66-90 per cent.) when the serum is diluted from 1 in 5 to 1 in 50. The degree of agglutinating power in serums from the same animal species appears generally speaking to bear no relation to

the severity of the lesions or the virulence of the infecting organism. Serums from cases of miliary tuberculosis often fail to produce the reaction. Tuberculous serous exudates (peritonitis, pleurisy) in most cases have the property of agglutinating the tubercle bacillus.

The technique of agglutination is as follows :

Take four small sterile test-tubes 5-6 cm. long. A little of the pure culture is put into the first and acts as a control : into the other three a mixture of serum and culture is introduced in different proportions : thus, into the second 1 drop of serum and 5 drops of culture, into the third 1 of serum and 10 of culture and into the fourth 1 of serum and 15 of culture. After shaking, the tubes are placed at an angle of 45° and kept at laboratory temperature. Agglutination only appears after the mixtures have been put up a few hours. The tubes should be examined several times during the next 24 hours and against a black ground. When the reaction is complete the fluid is clear and there is a slight deposit at the bottom of the tube. A complete reaction giving this appearance is alone of diagnostic value. The diagnosis should always be completed by microscopical examination of the clumps (between a slide and cover-glass and unstained).

The power of agglutination possessed by the serum of persons suffering from tuberculosis is of very limited diagnostic value for the following reasons :

1. Homogeneous cultures are often agglutinated by the serum of healthy persons—26 times out of 100 examined (Arloing and Courmont) : 50 per cent. of cases according to German statistics.

2. The serum of persons suffering from febrile diseases other than tuberculosis (enteric fever, puerperal fever, pneumonia, etc.) nearly always agglutinates homogeneous cultures of the tubercle bacillus.

3. The serum of tuberculous subjects does not always agglutinate homogeneous cultures of the infecting organism. A negative reaction is especially frequent in cases of advanced phthisis, miliary tuberculosis, and "galloping" consumption. The reaction is often absent in the very early stages of the disease, and is practically never obtained in cases of lupus. Bezançon, Grifon and Philibert obtained a positive reaction in about 83 per cent. of cases of undoubted tuberculosis : Ivanova observed agglutination in 66 per cent. of cases of tuberculosis and in 60 per cent. of non-tuberculous persons.

4. The method is very delicate in practice and the most minute precautions must be taken in the preparation of the homogeneous cultures.

(ii) Vasilescu describes a medium which he says gives homogeneous cultures more easily than Arloing's method.

The medium has the following composition :

| | | | | | | | | | | |
|---------------------------|---|---|---|---|---|---|---|---|----|------|
| Clear sterile calf serum, | - | - | - | - | - | - | - | - | 25 | c.c. |
| Distilled water, | - | - | - | - | - | - | - | - | 75 | " |
| Neutral glycerin, | - | - | - | - | - | - | - | - | 3 | " |

Heat the mixture to 100° C. in a water bath, distribute into tubes of 2 cm. diameter in quantities sufficient to give a column 3 cm. high in each tube. Sterilize at 120° C. for 15 minutes (the medium does not coagulate). Sow with a bacillus of the human type. Incubate at 37° C. and shake the tubes every day. After two sub-cultures in this medium the growth is homogeneous.

(iii) Hawthorn suggests a simplification of Arloing's technique. He sub-cultures an homogeneous culture in glycerin-broth in 2 per cent. peptone saline solution. By this means an homogeneous culture consisting of motile bacilli is obtained in 48 hours without shaking the flask. These cultures are more sensitive for the agglutination reaction than Arloing's.

Vincent repeated Hawthorn's experiments and always found that the cultures in the peptone saline medium were agglutinated even when the serum of non-tuberculous persons was used (in dilutions of 1 in 30 and 1 in

40). The method therefore is not available for the agglutination reaction in tuberculosis.

(iv) For the agglutination-reaction German authors prefer an emulsion of tubercle bacilli ground up in a mortar. Von Behring uses an emulsion of bacilli triturated in an agate mortar and afterwards desiccated. Koch recommends the use of the powdered bodies of bacilli obtained in the preparation of tuberculin TR, dried and emulsified in a 1 per cent. solution of sodium chloride. In bacillary extracts, obtained by triturating tubercle bacilli as described in the preparation of tuberculin TR, and freed from bacilli by centrifugation, agglutinating serums produce agglutination in dilutions of 1 in 10 to 1 in 50. This method is recommended by Koch and Romberg.

Kœppen uses an emulsion obtained by saponification which has the advantage of keeping well and of being of such a degree of concentration that, after agglutination, the fluid becomes quite clear.

To prepare the emulsion described by Kœppen filter a glycerin-broth culture through filter paper: wash the bacilli with normal saline solution and dry, *in vacuo*, at the ordinary temperature. To 1 gram of dried bacilli add 3 c.c. of a warm aqueous solution of potash (33 per cent.): leave to stand for a few hours, then rub up the mixture and place the emulsion in the warm incubator (37° C.) for several hours; finally heat in a water bath for 15 minutes at 100° C. The emulsion is now of a thick consistency and is again heated, the water which evaporates being replaced by alcohol drop by drop. Soaps are formed which are dissolved in 100 c.c. of warm distilled water. For the purposes of the agglutination reaction 1.5 c.c. of the milky emulsion is mixed with 50–100 c.c. of normal saline solution.

(v) Wright and Douglas heat a glycerin-broth culture of the tubercle bacillus to 60° C. for 1 hour, filter it through paper, grind it up in a mortar, and emulsify in water containing 0.1 per cent. of sodium chloride and 0.5 per cent. carbolic acid. They then centrifuge the emulsion to remove any bacterial masses which have not been resolved into their elements. This liquid is only agglutinated by normal human serum in dilutions of 1 in 2 to 1 in 4 while tuberculous serums agglutinate it in dilutions of 1 in 10 to 1 in 50.

6. Immune bodies (Sensibilisatrices).

The presence of immune bodies is very inconstant in the serum of persons suffering from tuberculosis. The method of complement fixation is, therefore, not applicable to the diagnosis of tuberculosis (Widal and Le Sourd, Camus and Pagniez, Wassermann and others).

SECTION IV.—THE DETECTION OF THE TUBERCLE BACILLUS.

The methods employed for detecting the tubercle bacillus vary in detail according to the nature of the material to be examined but in every case three methods of investigation are available.

1. **Microscopical examination.**—Fluids, tissues or other material suspected to contain the bacillus must be stained by Ziehl's or Ehrlich's method. The tubercle bacillus is the only organism which will resist the decolorization used in these methods. As a matter of fact two other [parasitic human] organisms might be mistaken for the tubercle bacillus, namely, the bacillus of leprosy and the smegma bacillus.¹

¹ The bacillus of verruga can be left out of account. The disease has so far been very little studied and is unknown in these climates.

The methods of differentiating the former are considered elsewhere (Chap. XIX.). In the case of the smegma bacillus there is hardly any fear of making a mistake if it be remembered (i) where this organism is found and (ii) that though it resembles the tubercle bacillus in resisting the decolourizing action of mineral acids, it differs from it in being rapidly decolourized by alcohol (probably because alcohol dissolves the fatty matter which impregnates it). In short, if Ziehl-Neelsen's method be carried out in the manner described above no confusion is likely to arise (p. 307). To avoid all possible chance of mistake in difficult cases, Bezançon and Philibert advise staining in the warm for 10 minutes, decolourizing in 33 per cent. nitric acid for 2 minutes and in absolute alcohol for 5 minutes.

It must not be forgotten that saprophytic acid-fast bacilli are found in the ambient media, and in milk, butter, etc. (p. 347).

These organisms might conceivably be a serious source of error in the detection of the tubercle bacillus. But they are often only feebly resistant to acid and are frequently decolourized by absolute alcohol alone. If there be any doubt the difficulty can be cleared up by inoculation.

Films are prepared in the ordinary way. Tissues should be hardened in alcohol or acid perchloride. [Eastwood (for the English Commission) hardened tissues in 10 per cent. formalin for a few days then washed well in water and transferred to Muller's fluid.]

2. Inoculations.—In those cases, which, in practice, are far from infrequent, in which microscopical examination fails to reveal the presence of the tubercle bacillus resort must be had to animal inoculation. Guinea-pigs being the most susceptible animals are always used for the purpose. When the material is free from other organisms, as, for instance, in the case of caseo-pus, pleural fluid, etc. it may be inoculated into the peritoneal cavity but in other cases (sputum, pus from a fistula, etc.) it is best to inoculate it beneath the skin otherwise there is the risk of setting up a septic peritonitis which will kill the animal before the tubercle bacillus has had time to produce its characteristic lesions. [Our experience would lead us invariably to inoculate intra-peritoneally when the material contains other organisms. It would seem that the peritoneal fluid possesses a quality lacking in the sub-cutaneous tissues of destroying putrefactive and other organisms.]

For purposes of rapid diagnosis, Nattan-Larrier and Griffon advise the inoculation of the suspected material into the mammary gland of a guinea-pig during the period of lactation. The bacilli multiply in the gland and after a week or a fortnight they can be detected in the milk by staining the latter by Ziehl-Neelsen's method.

Osman Nouri has drawn attention to the advantages of inoculating an animal by rubbing the material into the skin after shaving it (p. 299).

Bloch advises that the suspected material should be inoculated sub-cutaneously into the inguinal region of a guinea-pig and that the inguinal glands should then be squeezed and manipulated between the fingers to bruise them and so render them more susceptible to infection. Under these conditions, if the material (urine, etc.) contained the tubercle bacillus the glands will be found enlarged, inflamed and even suppurating when the animal is killed 9 days after inoculation. The method is not reliable; tubercle bacilli cannot be found on microscopical examination when the animal is killed 9 days after inoculation; moreover under the conditions of the experiment, acid-fast bacilli, Staphylococci, etc. may equally with the tubercle bacillus cause swelling and supuration of the glands.

3. Cultures.—Cultures are very rarely used as a means of detecting the tubercle bacillus in a pathological product. To obtain cultures not only must the material be rich in tubercle bacilli [and free from contaminating organisms] but there must be a good deal of it. Cultures, however, are particularly successful in the case of sputum.

A. Sputum.

1. Microscopical examination.—The search for tubercle bacilli in sputum is easy when the latter is purulent and the bacilli are present in large numbers. It is much more difficult and often unsuccessful when the sputum is scanty and mucous in character and derived from a recent lesion or again when the sputum consists almost entirely of blood. As a rule, the sputum coughed up by the patient in the early morning gives the most satisfactory results.

In the case of nummular sputum it is only necessary to pick up a small fragment from the centre of a purulent mass with a loop and spread it on a cover-glass [or slide] in the ordinary way. The yellowish lumps found in tuberculous sputum are very rich in bacilli and should therefore be selected; similarly, in mucous sputum, the solid particles suspended in the more fluid portion should, as far as possible, provide the material for examination.

It is very difficult to find the tubercle bacillus in the blood coughed up during an attack of hæmoptysis; it can be more readily found in the consolidated sputum streaked with blood which is expectorated in the days following the hæmorrhage.

Bacilli can seldom be detected in the sputum of persons suffering from miliary tuberculosis; [it would seem that] the bacilli only pass into the sputum when purulent lesions are breaking down.

The tubercle bacillus is present also in the expectoration of tuberculous cattle (Riddoch) and a good method of diagnosing the disease in cattle is to collect some of the muco-purulent material from the partitions in the sheds and to examine it for the bacillus after staining in the ordinary way.

Homogenization.—When the bacilli are likely to be few in number the sputum must be specially treated before they can be detected: the sputum must be liquefied and made homogeneous, and then be left to deposit or else be centrifuged. Under these conditions the deposit contains in a small volume all the bacilli which were in the viscous mass. It is then a simple matter to stain and detect them.

1. Biedert's method.—To 15–20 c.c. of sputum add 30–40 c.c. of water and a few drops (6–15) of soda—the thicker and more viscous the sputum the larger must be the quantity of soda added. Boil the mixture in a porcelain dish until it is quite homogeneous, then dilute with one or two volumes of water and boil again for a minute or two. Put the mixture aside for 48 hours, then pour off the supernatant fluid and prepare films with the deposit. Or, after boiling, the mixture may be centrifuged and the deposit used for making films.

2. Ilkewitsch's method.—Mix 0.5 c.c. of sputum with 20 c.c. of distilled water and about 10 drops of a 3 per cent. solution of caustic potash. Heat the mixture in a porcelain dish but without letting it boil, stirring all the time until the mixture is homogeneous. Add a little casein and a drop or two of a 3 per cent. solution of caustic potash and continue the heating until the mixture has a milky appearance, then pour into centrifuge tubes, add a few drops of acetic acid until coagulation is just beginning, centrifuge for a few minutes and use the deposit for making films.

3. Ellermann and Erlandsen's method.—Mix 10–15 c.c. of sputum with one-half its volume of a 0.6 per cent. solution of sodium carbonate in a small flask and place in the incubator at 37° C. for 24 hours. Then decant the supernatant fluid and centrifuge the remainder. To the deposit add 4 times its volume of 0.25 per cent. soda solution, mix, centrifuge again and use the deposit for preparing films.

According to Ellermann and Erlandsen, and Bertarelli, this method is better than any other which has been described.

4. Abbé's method.—Place 5–10 c.c. of sputum in a cylindrical vessel, add 15–30 c.c. of a perchloride solution (perchloride of mercury, 2 grams; salt, 10 grams; distilled water, 1000 c.c.); mix thoroughly, centrifuge 15 c.c. of the mixture and make films with the deposit.

5. Sprengler's method.—Mix 10 c.c. of sputum with 10 c.c. of warm water and a

drop of normal soda solution, add 0.25–0.50 gram of pancreatin and incubate at 37° C. for 2 or 3 hours. Then centrifuge or pour into a conical glass vessel with a crystal of thymol added to hinder putrefaction and leave to stand for 12 or 14 hours: decant the supernatant liquid and prepare films with the deposit.

6. **Jousset's method.**—Digest the sputum for 2 or 3 hours in the warm incubator (38° C.) with 10–30 c.c. of artificial gastric juice made as follows:

| | |
|------------------------------|-------------------------|
| Pepsin, - - - - - | 2 grams. |
| Pure glycerin, - - - - - | } - - - - - ää. 10 c.c. |
| Hydrochloric acid, - - - - - | |
| Sodium fluoride, - - - - - | 3 grams. |
| Distilled water, - - - - - | Q.S. to 1000 c.c. |

When completely peptonized, centrifuge and examine the deposit for tubercle bacilli (p. 342).

Films made from sputum or from the deposit after solution of the sputum are stained by one or other of the methods already described, Ziehl-Neelsen's method being the most satisfactory.

2. **Inoculations.**—In a doubtful case of pulmonary phthisis when no bacilli can be found in the sputum on microscopical examination, animal inoculation must be resorted to for purposes of diagnosis. The sputum must be collected as free from other organisms as possible (p. 192) and an emulsion of it, prepared by rubbing up in sterile water, inoculated beneath the skin of a guinea-pig. Should the sputum contain tubercle bacilli the animal soon shows signs of infection (p. 297). On account of the risk of setting up a fatal septic peritonitis sputum should never be inoculated into the peritoneal cavity [but see p. 338, 2. Inoculations].

3. **Cultures.**—It is very rarely that cultures are sown with sputum for purposes of diagnosis; indeed for a long time it was thought impossible to obtain a pure culture of the bacillus from sputum. Kitasato, Pastor and others have, however, described methods by which it may be effected.

(a) **Kitasato's method.**—After the mouth has been washed out with sterile water, induce the patient to cough, and collect the sputum in a sterile glass vessel. Wash the sputum in a number (10) of glass vessels containing sterile water (p. 192) then, adopting the ordinary precautions to prevent contamination, lift a small fragment from the centre of the purulent mass and spread it on glycerin-serum. Sow a large number of tubes. Growth appears after the tubes have been incubated at 38° C. for about 10 or 12 days.

(b) **Pastor's method.**—Collect the sputum with the same precautions as in Kitasato's method. Emulsify in a little sterile water and filter through a piece of sterile gauze. Sow a tube of liquefied gelatin with a few drops of the filtrate, pour into a Petri dish and allow it to set. After incubating for 3 or 4 days at 20° C. any contaminating organisms that may have been present will have grown giving rise to numerous colonies. With a sterile scalpel cut out those portions of the gelatin on which there is no growth and transfer them to tubes of glycerin-serum; if a number of tubes be sown a pure culture of the tubercle bacillus will be obtained on some of them.

(c) **Hesse's method.**—Hesse's medium (p. 317) is most useful for isolating the tubercle bacillus from sputum. The sputum is washed by Kitasato's method and sown on the agar in Petri dishes. After incubating at 37° C. for about 10 hours the number of tubercle bacilli in the fragments of sputum will be found to have considerably increased and colonies will be visible to the naked eye at about the sixth day.

(d) **Jockmann's method.**—Jockmann uses the following medium which is similar to Hesse's:

| | |
|--|----------|
| Heyden's albumose (<i>Nährstoff Heyden</i>), - - - - - | 5 grams. |
| Salt, - - - - - | 5 " |
| Neutral glycerin, - - - - - | 30 " |
| Normal soda solution, - - - - - | 5 c.c. |
| Water, - - - - - | 1000 " |

Sterilize. To 20 c.c. of this broth add 10 c.c. of sputum, mix thoroughly and incubate at 37° C. After incubating for 24 hours the bacilli will have increased in number and films can be prepared with the deposit and stained with carbol-fuchsin. This method facilitates the detection of tubercle bacilli when they are present in the sputum in small numbers only.

(e) **Spengler's method.**—Tubercle bacilli are more resistant to the action of formalin vapour than most other bacteria and it is upon this fact that the following method is based. Dworetzky states that he has not had good results.

Cover the bottom of a Petri dish with a filter paper, spread 3 c.c. of sputum in a layer not more than 2.5 mm. thick and sprinkle with pancreatin to facilitate digestion of the mucus. Line the lid of the dish with filter paper soaked in a few drops of commercial formalin. Incubate the dish and its contents at 20°–25° C. After incubating for 2 hours it is said that all micro-organisms other than the tubercle bacillus are killed so that if tubes of glycerin-agar be now sown with the sputum a pure culture of the tubercle bacillus will be obtained.

[(f) **Griffith's method.**—A. S. Griffith (for the English Commission) obtained cultures direct from sputum by using antiformin.¹ The method he employed at first was that recommended by Uhlenhuth; diluted sputum and antiformin were mixed together to form a 15 per cent. antiformin-sputum mixture and allowed to stand for 3 hours; the solution was then centrifuged, the deposit washed and recentrifuged, and the second deposit sown on to culture media. In subsequent experiments however he found that a 10 per cent. dilution of antiformin allowed to act for 20–30 minutes gave better results (see fig. 208 (a), p. 317).]

(g) Spengler recommends another method based on the resistance of the tubercle bacillus to heat and only applicable to nummular sputum.

Take up a large fragment of the nummular sputum in a platinum loop and hold it near a flame so that the sputum is roasted but not detached from the loop. Repeat the process three or four times then sow the flamed sputum on 2 per cent. glycerin-serum or on glycerin-agar. Growth appears in a week to 10 days. Spengler acknowledges that this requires a certain amount of skill.

In a case of advanced pulmonary tuberculosis recorded by Bertarelli the sputum [appeared to] consist solely of tubercle bacilli which when sown direct on to glycerin-serum and blood-agar readily gave a pure culture of the bacillus. Such cases are very exceptional; and undoubtedly the most certain method of obtaining a pure culture from sputum is to inoculate a guinea-pig and sow cultures from the lesions which develop (p. 314).

B. Blood.

The tubercle bacillus rarely passes into the blood of persons affected with tuberculosis. Lustig and others have, however, succeeded in staining the bacillus in films prepared with blood obtained by pricking the finger or the spleen (in miliary tuberculosis). The bacillus is more easily demonstrated in the clots formed *post mortem* in the heart and blood vessels. The carbol-fuchsin method should be employed for staining the preparations.

Bezançon and Griffon, and Jousset have described methods designed to facilitate the detection of the organism in the blood. The results of the methods are, however, vitiated by the occurrence in the surrounding air of acid-fast bacilli and of saprophytic bacilli which acquire acid-fast properties in organic products. To secure the best results from these methods they ought to be carried out under strictly aseptic conditions, and this in practice is difficult

[¹ Antiformin is a mixture of sodium hydroxide and Eau de Javelle. It has the power of dissolving albuminous substances and of killing and dissolving all bacteria except those which like the tubercle bacillus possess a waxy envelope.]

of accomplishment. Under strictly aseptic conditions, Bergeron has repeatedly failed to detect the presence of tubercle bacilli in blood by Jousset's method.

(a) **Bezançon and Griffon's method.**—To 5 c.c. of blood add 5 c.c. of distilled water and 5 drops of soda and triturate the mixture in a mortar until completely dissolved. Then add 20 c.c. of water and boil in a porcelain dish for 5 minutes. Centrifuge the product for 10 minutes, prepare films and stain with carbol-fuchsin.

(b) **Jousset's method (Inoscopy).**—To 30 c.c. of blood add 100 c.c. of distilled water. Digest the clot with artificial gastric juice (p. 340) for 2 or 3 hours in the warm incubator (38° C.). Centrifuge the product, stain the deposit with carbol-fuchsin, and examine it for tubercle bacilli.

(c) **Nattan-Larrier and Bergeron's method.**—In this method the blood is received direct from the vein into twenty times its volume of sterile distilled water; the blood hæmolyzes; the hæmolyzed mixture is centrifuged and the deposit examined for bacilli.

(d) Blood may be collected in sodium citrate solution to prevent it clotting, centrifuged and the deposit examined. Lesieur utilizes the anti-coagulating property of the digestive juices of leeches. A leech is put on the patient and when gorged with blood it is pressed and the product centrifuged.

C. Pus.

In pus from a tuberculous lesion the bacilli are present in small numbers only so that search for the organism in films often has a negative result. One or other of the methods of homogenization described above when dealing with sputum may with advantage be adopted, though it is always preferable to inoculate a guinea-pig. The tubercle bacillus in the majority of cases occurs in pure culture in tuberculous pus but in other cases it may be associated with the ordinary pyogenic organisms and particularly with staphylococci.

D. Exudates.

In the sero-fibrinous exudates which occur in pleurisy, peritonitis, pericarditis, etc., direct examination for the tubercle bacillus by microscopical examination always gives negative results.¹

Jousset appears to have obtained remarkable results by applying the method of inoscopy to the detection of the tubercle bacillus; he found the bacillus in all sero-fibrinous exudates. Unfortunately this method involves risk of error by reason of the presence of acid-fast bacilli in the surrounding air (p. 341) and the bacilli stained by Jousset were, at least in most cases, evidently not the tubercle bacillus. Jousset himself noted their abnormal forms and the ease with which they were decolorized by too long immersion in acid (p. 345). Moreover, the method of inoscopy usually gives negative results when it is applied under strictly aseptic conditions (Bergeron).

Jousset's technique.—If the liquid be spontaneously coagulable it is allowed to clot and the clot treated as described above in the case of blood. When the liquid does not coagulate spontaneously (cerebro-spinal fluid, for example) some horse-blood plasma is added to form a clot and this is then treated in the ordinary way. Horse plasma is obtained by mixing equal volumes of horse-blood and 10 per cent. solution of sodium chloride, centrifuging and collecting the supernatant fluid.

Satisfactory results may be obtained by sowing the exudate on blood-

[¹ Though this statement is true in the majority of cases its application is not so universal as the author's experience would lead him to think. Microscopical examination of fluid from cases of tuberculous pleurisy may show the presence of tubercle bacilli and occasionally in extraordinarily large numbers.]

agar. Bezançon and Griffon obtained cultures in 12–15 days from ten cases of tuberculous meningitis by sowing the cerebro-spinal fluid. And the same authors obtained cultures of the tubercle bacillus in two cases of sero-fibrinous pleurisy.

The classical method is to inoculate a guinea-pig with the suspected fluid. But in this connexion it must be borne in mind that inoculation of tuberculous pleural fluid gives negative results in three-quarters of the cases. [This is probably because the fluid is actually free from tubercle bacilli since “an extremely small number of bacilli is able to induce a progressive tuberculosis in the guinea-pig” (A. S. Griffith, for the English Commission).] Inoculation is best done into the peritoneum with a large quantity (10–15 c.c.) of the fluid, which must, of course, be collected aseptically. To ascertain the degree of virulence of the bacillus a rabbit should be inoculated at the same time, for a bacillus which will infect a guinea-pig often produces no lesion in a rabbit (Arloing). [Rabbits inoculated with very small doses of the human tubercle bacillus frequently show no tuberculous lesions when killed (English Commission).]

Debove and Renault's method.—Debove and Renault have devised a very ingenious method for deciding the nature of a suspected tuberculous exudate. They showed that tuberculous exudates contain tuberculin. The inoculation of a small quantity of a pleural or pericardial exudate into a tuberculous guinea-pig gives the characteristic tuberculin reaction (p. 324).

E. Granulomata.

In the majority of cases microscopical examination fails to reveal the presence of the tubercle bacillus. A small piece of the growth should in this event be inoculated beneath the skin of a guinea-pig.

F. Nasal cavities.

Strauss has shown that tubercle bacilli are frequently found (once out of three times) in the nasal fossæ of healthy subjects living in close contact with persons suffering from phthisis. The following paragraph describes Strauss' technique.

Prepare a number of small swabs by rolling a little piece of absorbent wool round the end of a small stick of wood (10–15 cm. long) [or stout iron wire] and sterilize them in wool-plugged test tubes in the hot air sterilizer. Pass one of these sterile swabs into the nasal cavity and by rubbing it gently over the mucous membrane collect the dust and mucus adhering to it. Wash the swab in a little sterile water. Repeat the operation six or eight times in each case and wash the different swabs in the same water, then inoculate the emulsion into the peritoneal cavity of a guinea-pig.

G. Urine.

Microscopical examination for tubercle bacilli of the urine of patients affected with tuberculosis of the urinary passages often gives negative results even when the urine has been centrifuged and the deposit used for examination. It must not be expected that large numbers of bacilli will be found even in the most favourable cases: should, however, a large number of acid-fast bacilli be found on microscopical examination of a urine the result should be regarded with suspicion and the examination done again, decolourizing with alcohol for a long time. This would be a typical case for inoculation.

In cases of acute tuberculosis even when there is no lesion of the urinary passages the tubercle bacillus may pass into the urine (Benda, Weichselbaum, L. Fournier and Beaufumé).

Pour the urine into a conical glass vessel and add a small crystal of thymol or camphor. If there is an abundant deposit of pus homogenize the deposit and centrifuge. If only a small deposit is formed, decant the supernatant liquid and prepare films with the deposit. If after 24 hours there is only a minimal deposit, decant the upper part of the liquid, add an equal volume of 95 per cent. alcohol to the few cubic centimetres of liquid remaining in the vessel, mix and centrifuge.



FIG. 212.—Tubercle bacilli in urine. (Carbol-fuchsin and methylene blue.)
(Oc. 2, obj. $\frac{1}{4}$ th, Zeiss.)

When a urine contains only a few cells the deposit adheres badly to the cover-glasses and is liable to be washed off in the staining process. This difficulty is especially encountered when the urine yields a large bulky precipitate of crystals of urates on centrifuging. To overcome this, Trevithic recommends washing the deposit several times in distilled water but the method does not seem altogether reliable. The author prefers to heat the urine to 40–45° C., centrifuge and wash the deposit once with distilled water at 45° C. When the deposit is very small, it may be mixed with 2 or 3 drops of a mixture of fresh egg albumin and distilled water (1–3) which fixes the deposit on the slide better.

Jousset's method has been utilized for the detection of the tubercle bacillus in urine. Add some blood plasma to the urine, digest the clot which forms with artificial gastric juice (p. 340) and centrifuge. Examine the deposit for tubercle bacilli. It must not be forgotten that this method more than any other is liable to lead to error on account of the presence of other acid-fast bacilli—particularly of the smegma bacillus which is easily mistaken for the tubercle bacillus.

The only certain method of detecting the tubercle bacillus in urine is to inoculate a guinea-pig. When the urine can be collected aseptically and is not contaminated either with the colon bacillus or other pyogenic organisms a few cubic centimetres may be inoculated into the peritoneal cavity of a guinea-pig. In the contrary case the urine should be inoculated sub-cutaneously. It has also been recommended that the deposit obtained on centrifuging the digested clot in Jousset's method should be inoculated.

H. Excreta.

[Acid-fast bacilli having the morphological properties and staining reactions of the tubercle bacillus can often be seen in films made with the excreta of

tuberculous subjects and sometimes in very large numbers. In order to determine whether these bacilli are tubercle bacilli or no resort must always be had to guinea-pig inoculation.]

I. Milk.

Tubercle bacilli occur only in small numbers in milk and the chances of finding them by microscopical examination are far from great. [Moreover non-pathogenic acid-fast bacilli (*infra*) are of frequent occurrence in cow's milk and no reliance can be placed upon microscopical examination for the detection of tubercle bacilli in milk.] Several methods have been described for detecting the bacillus in milk.

(a) Leave the fresh milk to stand for 24 hours and examine the deposit.

(b) Centrifuge and use the precipitate for making films.

(c) Coagulate 200 c.c. of milk with a little powdered citric acid, filter, dissolve the precipitate on the filter in a solution of sodium phosphate, pour the liquid into a large test-tube, add a few cubic centimetres of ether, shake for 10 minutes or so, decant the ether with the fat in suspension, centrifuge the aqueous fluid and examine the deposit.

With milk as with urine the only certain method of ascertaining whether a given specimen contains the tubercle bacillus is to inoculate a few cubic centimetres collected as aseptically as possible into the peritoneum of a guinea-pig. [Stand the milk in the ice chest for 12 hours. Pipette off some of the cream into one sterile centrifuge tube and the deposit into another. Centrifuge and inoculate 3 c.c. of the cream from the first tube into one guinea-pig and 3 c.c. of the deposit from the second into another guinea-pig.]

[A. S. Griffith and others have shown that tubercle bacilli are found in the milk of cows suffering from tuberculosis quite independently of whether there is disease of the udder or not. The bacilli cannot however be detected on every occasion on which the milk is tested. F. Griffith suggests in explanation of this fact "that the quantity of milk" (50 c.c.) "inoculated was not sufficient to be representative rather than that the elimination of tubercle bacilli was irregular since in several of the animals" (inoculated with the milk) "the slight amount of disease produced showed that only a few bacilli had been inoculated." And this explanation is supported by the fact that if a number of guinea-pigs say eight be each inoculated with the same quantity of the same milk often not more than one animal develops tuberculosis.]

THE ACID-FAST, OR PARA-TUBERCLE, BACILLI.

Besides the leprosy bacillus, the bacillus of verruga and the smegma bacillus there is a number of bacilli which share with the tubercle bacillus the property of resisting the decolourizing action of acids. These organisms, variously described as *acido-phile*, *acid-fast*, or *para-tubercle* bacilli, have been described by Petri, Rabinowitsch, Rübner, Beck, Obermüller, Coggi, and Möller as occurring in milk, butter, manure, grass, air, and so on. Möller, in particular, has described several species of these organisms (the manure bacillus or *Mistbazillus*, the grass bacillus or *Grasbazillus*, and the Timothy-grass bacillus or *Timothee bazillus*). Similar bacilli have been found in various pathological conditions in man *e.g.* in gangrene of the lung (Pappenheim, Meyer, Lydia Rabinowitsch, and others) in conditions of the eye simulating tuberculosis (Guisberg), in various pulmonary diseases (Möller, Flexner, Ohlmacher, and others) and in diseases of the alimentary canal (Mironescu) etc.—The ichthic bacillus described by Dubard also belongs to this group.

None of these bacilli which morphologically resemble the tubercle bacillus can be distinguished from the latter in microscopical preparations: when stained they are not decolourized by acid and even sometimes not by alcohol. According to

Borrel their morphological characteristic as in the case of the tubercle bacillus is to remain a bright red colour when treated in the following manner

1. Stain with carbol-fuchsin in the warm for 5 or 10 minutes.
2. Treat with 2 per cent. aniline hydrochloride for 1 or 2 minutes.
3. Decolourize in absolute alcohol.
4. Differentiate with a dilute aqueous solution of methylene blue.

They are distinguished from the tubercle bacillus, (1) by the ease with which they can be grown on various media containing no glycerin at the ordinary temperature of the laboratory (2) by their cultural characteristics (luxuriant and generally greasy and creamy) and (3) finally and especially, *by the fact that they do not produce tuberculin*. Ramond and Ravaut, Bataillon and Terre have described an ichthic tuberculin similar to human tuberculin but their results have not been confirmed (p. 296).

Some of the members of this group are pathogenic to animals, particularly guinea-pigs, and may set up either local lesions distinctly tuberculous in appearance or pseudo-miliary-tuberculozes (*Timothee bacillus*) which have a tendency to suppurate.

Finally, several authors have directed attention to the existence of *pseudo-acid-fast* bacilli (Bezançon and Philibert, Bienstock, and others). A large number of saprophytic bacilli as a result of living in contact with fatty substances acquire, accidentally, as it were, acid-fast properties (e.g. *B. smegmæ*) which are lost as soon as they are grown on ordinary culture media. Other saprophytic bacilli become acid-fast when grown in blood or sero-fibrinous exudates (Bezançon and Philibert). The *Bacillus anthracis*, *Bacillus subtilis* (Bienstock), *Bacillus entericæ febris* (Ramond and Ravaut), and *Bacillus diphtheriæ* (Bezançon and Philibert) become acid-fast when grown in media containing butter. But all these pseudo-acid-fast bacilli are decolourized by prolonged treatment with acid and especially by alcohol (pp. 306 and 342); and moreover, unlike the tubercle bacillus, they can be stained with Unna's blue (10 minutes).

There should therefore be no reason for confusing the tubercle bacillus with the para-tubercle bacilli.

The smegma bacillus.

Tavel, Alvarez, Matterstock have isolated from normal smegma a bacillus which resists decolourization by acids. This is the bacillus which Lustgarten described as the cause of syphilis. It has not been grown outside the body and is decolourized by acid-alcohol; it should not therefore be difficult to differentiate it from the tubercle bacillus. Houssell's method is the best for purposes of micro-chemical diagnosis. The technique is as follows.

Stain the film in the warm for 2 minutes with carbol-fuchsin. Wash. Treat for 10 minutes with acid-alcohol.

| | | | | | | | | | | |
|-------------------------|---|---|---|---|---|---|---|---|-----|------|
| Absolute alcohol, | - | - | - | - | - | - | - | - | 100 | c.c. |
| Pure hydrochloric acid, | - | - | - | - | - | - | - | - | 3 | " |

Wash again. Stain with an aqueous solution of methylene blue.

| | | | | | | | | | | |
|---|---|---|---|---|---|---|---|---|----|------|
| Saturated aqueous solution of methylene blue, | - | - | - | - | - | - | - | - | 50 | c.c. |
| Distilled water, | - | - | - | - | - | - | - | - | 50 | " |

Wash. Dry. Mount. The smegma bacillus will be stained blue, the tubercle bacillus, red.

The bacillus of verruga peruana.

Verruga is a disease found in certain valleys of the Andes. It affects man and some of the domestic animals. It occurs both as an acute and chronic disease and leads to the formation of granulomata on mucous surfaces, the skin and the viscera (Odrizola). Carriou inoculated himself with the blood of a person suffering from the chronic form of the disease and died of an acute infection. A dog, inoculated by Tamayo with 1 c.c. of the blood of a person suffering from verruga in an acute form, became infected with a typical attack of the disease and recovered. According to Ch. Nicolle and Letulle, the cause of verruga is a bacillus morphologically identical with the tubercle bacillus and staining by the Ziehl-Neelsen method. The organism has not been cultivated.

The Pseudo-tubercloses.

In addition to the tubercle bacillus there is a certain number of other pathogenic organisms capable of producing tubercles in the tissues.

The bacillus of leprosy and of glanders both lead to the formation of true tubercles. In connexion with the *Discomyces* it will be seen that some of the members of that group produce pseudo-tuberculous conditions in man and the lower animals.

Finally some bacteria give rise to lesions so closely simulating those produced by the tubercle bacillus that they may be mistaken for tuberculous lesions. These pseudo-tuberculous lesions may be classified into two groups, namely the *zooglic pseudo-tubercloses* of Malassez and Vignal, Chantemesse, and others: and the *bacillary pseudo-tubercloses* of Charrin and Roger, Dor, Courmont, and others.

The descriptions given by different authors do not at all coincide: perhaps they relate to a number of varieties of the same organism. It must suffice to have recorded the existence of this group of organisms: a description of them is beyond the scope of this work.

[The disease commonly known as pseudo-tuberculosis in guinea-pigs and rabbits is briefly described at p. 160.]

CHAPTER XIX.

BACILLUS LEPRÆ.

Introduction.

Section I.—Attempts to reproduce the disease experimentally, p. 348.

Section II.—Morphology, p. 350.

Section III.—Serum-therapy, p. 353.

Section IV.—Detection and identification of the leprosy bacillus, p. 354.

LEPROSY, the cause of which is a bacillus discovered by Hansen, is a contagious disease peculiar to man: the lower animals are never infected. A disease apparently very similar to human leprosy has however been described as occurring in the rat (Rabinowitsch and others); it takes the form of ulcers on the skin and swelling of the glands, and the lesions contain very large numbers of bacilli similar to the leprosy bacillus.¹

[Though there is no definite and absolutely conclusive proof of the ætiological rôle of the organism hitherto commonly known as the *bacillus lepræ* there can be no reasonable doubt but that the parasite is the cause of leprosy. Recent investigations however would seem to afford amply sufficient ground for believing that the organism is not a true bacterium but rather an hypomycete belonging to the genus *Discomyces* (*Streptothrix*). This being so it would be more exact to supersede its present designation by the name proposed by Deycke: *Streptothrix leproides*. These researches are also of interest in that they afford botanical evidence of the close relationship which has on other evidence been known for long enough to exist between the parasites of leprosy and tuberculosis.]

SECTION I.—ATTEMPTS TO REPRODUCE THE DISEASE EXPERIMENTALLY.

Most of the attempts made to reproduce the disease experimentally by inoculating the bacillus have failed.

In man, Arning is said to have succeeded in inoculating with leprosy the condemned criminal Keanu, but in this case the hypothesis of a spontaneously contracted infection may be pleaded: the same objection may be raised against two or three other cases in which leprosy is said to have been successfully transmitted by inoculation. Against these experiments of doubtful validity must be placed the very numerous unsuccessful attempts made by a number of different observers.

[¹ This disease is endemic in England, on the Continent, in Australia, in America, and in Japan.]

In the lower animals, with the probable exception of the monkey, the inoculation of leprous tissues or cultures of the organism produces no result [but *vide infra*].

In the lesions found by Melcher and Orthmann, and Tedeschi, after the inoculation of a rabbit with pieces of leprous tissue, the presence of what was probably the tubercle bacillus as well as other organisms unconnected with leprosy was demonstrated. Thiroux, in Madagascar, inoculated four rabbits with leprous nodules: all four animals developed typical and fatal tuberculosis; the tissues were sown and yielded cultures of the tubercle bacillus. Numerous inoculation experiments carried out on monkeys (Babès), pigs (Hilaret and Gaucher, Widal), dogs (Neisser, Danisch), rabbits (Wesener), and cold-blooded vertebrata (Kobner), and more recently the experiments of Besnier and Leloir, have all failed to give rise to leprosy in the inoculated animal.

A piece of leprous tissue inoculated beneath the skin of an animal retains its normal appearance for a long time, and the bacilli contained in it will stain even after the lapse of several months, but they never undergo any multiplication. The tissue is gradually absorbed by leucocytes which congregate around it.

C. Nicolle has succeeded in inoculating macacus monkeys with leprosy.

A non-ulcerated leprous nodule was pounded in a mortar and inoculated into the ear of a bonnet monkey (*Macacus sinensis*): sixty-two days later leprous nodules containing quite typical leprosy bacilli were found to have developed. Six other macacus monkeys (*Macacus sinensis* and *Macacus rhesus*) are said to have been successfully inoculated beneath the skin: by repeating the inoculations the susceptibility of the monkey is increased and the period of incubation can be reduced from two months to a fortnight (fourth inoculation). The lesions resolved spontaneously in 29-160 days. For purposes of inoculation, material rich in bacilli from untreated lesions should be used.

[Rost also successfully infected a monkey by repeatedly inoculating it with an organism which he had cultivated from a case of leprosy. The monkey exhibited all the clinical features of tuberculous leprosy and in the nodules acid-fast bacilli were found situated as in leprosy.

[Rost failed in his attempts to infect guinea-pigs, white rats and rabbits either by inoculation (sub-cutaneous and intra-peritoneal) or by feeding.

[Bayon inoculated rats and mice with an acid-resisting diphtheroid bacillus which he had cultivated from cases of human leprosy and found that the organism when recovered from the organs of these animals had acid-fast properties. This acid-fast organism when inoculated into a further series of rats and mice caused "the identical changes of genuine spontaneous rat leprosy and very striking analoga of the glands and organs of human cases."

[Williams with his pleomorphic streptothrix (*vide infra*) produced in guinea-pigs by sub-cutaneous inoculation a lesion somewhat resembling leprosy with large numbers of cocco-bacilli in the cells of the connective tissue.

[Duval used cultures 2-3 days old on glycerin-blood-agar. By inoculating monkeys (*Macacus rhesus*) sub-cutaneously two or three times at intervals he was able to produce lesions resembling those of leprosy. The monkeys lost all sensation to pain and the skin for a radius of 2-3 cm. about the nodules was distinctly hypersensitive. About 6-8 weeks after the first inoculation the animals exhibited typical signs of disseminated infection and presented the clinical picture of human leprosy of the tuberculous type.]

Sugai inoculated an emulsion made by grinding up young lepromata in normal saline solution into Japanese dancing mice, with the result that small granulomata similar to those of miliary tuberculosis appeared on the peritoneum while the mesenteric and bronchial glands became enlarged. The leprosy bacillus was present in the lesions.

SECTION II.—MORPHOLOGY.

1. Microscopical appearance.

A. In human lesions.—The leprosy bacillus is a slender rod-shaped organism with rounded ends, and of the same size as the tubercle bacillus ($5-6\mu \times 0.5\mu$).

Though it may be very slightly curved, it is generally speaking straighter than the tubercle bacillus; occasionally the ends are slightly swollen.

Staining reactions.—The leprosy bacillus, like the tubercle bacillus, stains by both Ehrlich's and Ziehl-Neelsen's methods, but is more acid-fast and therefore more difficult to decolourize than the tubercle bacillus. The two bacilli may therefore be differentiated by this characteristic. The leprosy bacillus retains the violet in Gram's method.

The following table gives the differential characteristics of the two bacilli.

| LEPROSY BACILLUS. | TUBERCLE BACILLUS. |
|--|--|
| Stains with aqueous solutions of the basic aniline dyes. | Does not stain with aqueous dyes containing no mordant. |
| Stains readily by Gram's method. | Stains with difficulty by Gram's method (p. 307). |
| Stains with Ziehl-Neelsen's and Ehrlich's solutions and resists decolourization for a long time. | Stains with Ziehl-Neelsen's and Ehrlich's solutions but is much more readily decolourized than the leprosy bacillus. |
| Stains by Baumgarten's method (<i>vide infra</i>). | Does not stain by Baumgarten's method. |
| Bacilli present in very large numbers within the cells of the leprosy nodule. | The tubercle cells contain only a few bacilli. |

Baumgarten's method of staining.—Stain for 5 minutes in the cold with aniline-violet, decolourize with the following solution:

Absolute alcohol, - - - 10 c.c.
Nitric acid, - - - 1 "

Wash in distilled water. Dry. Mount.

The leprosy bacillus is stained violet: the tubercle bacillus is decolourized.

Weil has shown that the leprosy bacillus only stains with Ziehl-Neelsen's and Baumgarten's methods when taken from young nodules. In lesions undergoing resolution these methods as well as Gram's fail to stain the bacillus.

When stained, the leprosy bacillus is often granular and its protoplasm contains irregular vacuoles. The ends are often swollen and stain easily: by some authors these swellings are regarded as spores.

Jamamoto's stain.—By staining in the manner now to be described Jama-



FIG. 213.—Bacillus of leprosy in a film from nasal mucus. Ziehl-Neelsen's method. $\times 1000$.

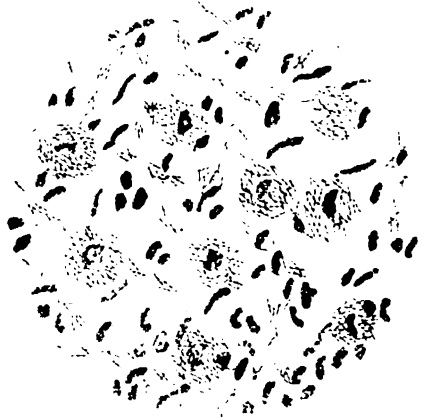

FIG. 214.—Section through a leprosy nodule in the larynx. Carbol-fuchsin and methylene blue. (Oc. 2, obj. Δ th, Zeiss.)

moto claims that the leprosy bacillus can be differentiated from the tubercle bacillus in films.

Fix the film in the flame, treat for 10 minutes in a bath of 5 per cent. solution of silver nitrate at 55°-60° C. and then transfer to the reducing solution :

| | |
|----------------------------|----------|
| Pyrogallol, - - - - - | 2 grams. |
| Tannin, - - - - - | 1 gram. |
| Distilled water, - - - - - | 100 c.c. |

Tubercle bacilli are stained black : leprosy bacilli are unstained and may be counter-stained by carbol-fuchsin.

[**B. In cultures.**—Rost found acid-fast bacteria massed together in parallel arrangement in his cultures from leprous nodules on milk-fish broth. When sub-cultivated on agar and broth a feebly acid-fast bacillus developed and it was found that the acid-fastness could be increased by growing the organism on milk. The organism is highly pleomorphic. In sub-cultures after 48 hours' incubation the appearance is the same as in the nodules of a leper. In older cultures or when grown under unfavourable conditions "degenerate forms are found which double or treble their usual length with a moniliform arrangement and lose their acid-fastness. These break down after a few days into clumps of small acid-fast coccoid forms."

[Bayon cultivated from cases of human leprosy an acid-resisting diphtheroid organism which acquired acid-fast properties on being inoculated into rats and mice.

[Williams grew a very pleomorphic streptothrix from the lesions of human leprosy "which in addition to changes in form exhibited marked changes in its staining reactions in regard to the quality known as acid-fastness." Williams describes the following forms :

- (a) On broth media and on potato-broth a non-acid-fast streptothrix in the mycelial stage which produced acid-fast rods.
- (β) On milk and lemco-broth a non-acid-fast diphtheroid bacillus which also produced acid-fast rods.
- (γ) On Rost's medium an acid-fast bacillus which is but the broken-down stage of a streptothrix, and
- (δ) On Dorset's egg medium an acid-fast mycelium. This streptothrix which was cultivated from a leper passed through respectively all the stages described above.]

2. Cultures.

Very little is yet known about the cultivation of the leprosy bacillus. Roux, Cornil, and Chantemesse failed in their attempts to grow the bacillus : numerous observers have obtained cultures after sowing pieces of leprous tissues, but in the great majority of cases these were cultures of organisms of secondary infection and not cultures of the leprosy bacillus (*vide infra*).

Bordoni-Uffreduzzi for example described certain growths as cultures of the leprosy bacillus which were obviously cultures of the tubercle bacillus : similarly Neisser's cultures were not cultures of the leprosy bacillus. Babès' cultures were cultures of a bacillus which did not stain either with Ehrlich's or Ziehl-Neelsen's stain : apparently also Ducrey's anaërobic organism may be dismissed without consideration.

Czaplewski, Spronck, Teich, Levy, Rost and others seem to have grown cultures of the leprosy bacillus, though it is to be noted that the descriptions of their cultures do not at all coincide.

Spronck sowed leprous bone marrow and non-ulcerated leprous nodules on neutral glycerin-potato : the growth was said to have been sub-cultivated on coagulated serum, glucose-glycerin-agar and glycerin-fish-broth (p. 319) but not on glycerin-potato. Growth took place at 25° C. and was copious at 37° C.

On glycerin-potato (primary culture).—After incubation for 10 days at 37° C. very small, yellowish, hardly visible colonies appeared.

On glucose-glycerin-agar.—Small, colourless, irregularly circular colonies.

On coagulated serum.—Small, greyish-yellow, irregularly circular colonies.

On fish broth.—A viscous precipitate adhering to the sides of the vessel.

Bacilli from these cultures were agglutinated by the blood of lepers in dilutions of 1 in 70 to 1 in 1000 and only in dilutions of 1-30 or 1-40 by the blood of other persons.

[Rost employed a medium of the following composition :

| | |
|---|----------|
| Distilled volatile alkaloid of rotten fish, | 250 c.c. |
| Weak Lemco broth (without peptone or salt), | 250 c.c. |
| Milk, | 50 c.c. |

which he sowed with material from cases of nodular leprosy and obtained in 3 days a slight stringy growth at the bottom of the tube which on microscopical examination proved to be masses of acid-fast bacteria. Sub-cultures were sown on agar and in broth (no salt or peptone) and a growth was obtained in 48 hours.

[Clegg grew the parasite of leprosy symbiotically with amœbæ and their symbiotic bacteria on an agar medium. After destroying the amœbæ and bacteria by heat at 60° C. for half an hour pure cultures of the organism were obtained by sub-cultivating on ordinary media—agar, potato, milk, etc.

[Duval used egg-albumin or human blood serum poured into sterile Petri dishes and inspissated for 3 hours at 70° C.

[The excised leprosy nodule is cut into thin slices (.5-1 mm.) and distributed over the surface of the albumin. After sowing, the medium is bathed in a 1 per cent. solution of trypsin added with a pipette but the tissue must not be submerged. Incubate at 20° C.¹ for a week to 10 days trypsin being added from time to time as evaporation necessitates.

[Sub-cultures may be sown on the albumin-trypsin medium but after sub-cultivating three or four times growth can be obtained on a glycerin-agar.

| | |
|----------------------------|-----------|
| Agar, | 20 grams. |
| Salt, | 3 " |
| Glycerin, | 30 c.c. |
| Distilled water, | 500 c.c. |

Mix, clear and sterilize in the usual manner.

To 10 c.c. of the agar at 42° C. add 5 c.c. of unheated turtle muscle infusion :

| | |
|---|------------|
| Turtle muscle cut into fine pieces, | 500 grams. |
| Water, | 500 c.c. |

Keep in the ice chest for 48 hours: filter through gauze and then through a Berkefeld filter.

[Duval claims that the organism he cultivated was the true leprosy parasite because with its aid he was able to produce the lesions of leprosy in a monkey.

[Twort has introduced a method of cultivation based upon the addition of sterilized tubercle bacilli to an egg medium. Growth is not visible to the naked eye for about 6 weeks.

[The material used was the nasal discharge and scrapings from a typical leper.

[The nasal discharge was first placed in a 2 per cent. solution of ericolin—a glucoside—at 38° C. for 1 hour to destroy contaminating organisms and the sediment was then used for sowing the culture medium.

[*The culture medium*.—Cultivations of the tubercle bacillus on Dorset's egg medium were steamed and the growth scraped off (care being taken to avoid the medium containing the waste products). The tubercle bacilli were ground up into an emulsion with glycerin and normal saline solution, steamed for 30 minutes and added to the yolk and white of new-laid eggs in the following proportions :

| | |
|--|-----------|
| Eggs, | 75 parts. |
| 8 per cent. saline solution, | 25 parts. |

Mix well and add tubercle bacilli 1 per cent. and glycerin 5 per cent. or less.

[The medium was tubed, heated to 60° C. for 1 hour and on the following morning

[¹ In his original experiments Duval incubated at 37° C. but now finds room temperature more suitable.]

incubated at 38° C. for 6 hours after which it was again heated in a water bath at 60° C. for 1 hour and then sloped at 85° C.

[The ericolized nasal discharge was sown and the tubes capped and incubated at 38° C. After 24 hours the medium had absorbed a quantity of the ericolin so the material was transferred to other tubes.

[The bacilli grew and were sub-cultivated in pure culture. In sub-cultures the bacilli were long, thin, beaded rods, well formed and quite acid-fast. Growth appears as a thin colourless film visible to the naked eye in 6 weeks.]

Bayon states that the most favourable media appear to be either placental-extract-glycerin-agar, or horse-serum-nutrose-agar containing 2 per cent. ground-up smegma bacilli (Twort's method). From the nodules of a case of leprosy this observer isolated an organism which "grew rapidly as a white viscid growth on placental-extract-glycerin-agar." Morphologically it assumes one of three forms: (i) a non-acid-fast and non-acid-resisting streptothrix, (ii) a pleomorphic, acid-resisting diphtheroid bacillus and (iii) a definitely acid-fast bacillus indistinguishable from the bacillus in the tissues.

The organism appears to be identical with that cultivated from leprosy lesions by Kedrowsky so long ago as 1901 and this latter Bayon regards as the true parasite of leprosy for the following reasons: it has been cultivated repeatedly from lepers, it causes leprosy lesions in rats and mice, it reacts specifically with the serum of lepers in a way that neither human nor avian tubercle bacilli react and lastly it is not identical with any other known organism.]

According to Ch. Nicolle and Weil, primary cultures of the leprosy bacillus can be obtained by sowing non-ulcerated leprosy tissue rich in bacilli in considerable amount in the water of condensation of glucose-glycerin-agar tubes to which serum may or may not have been added; the bacilli appear to grow solely at the expense of the cells of the material sown and cannot be sub-cultivated. Weil has also succeeded in growing cultures by sowing the material in the yolk of the whole egg and on yolk of egg-agar (p. 53, A); but here again sub-cultures could not be obtained.

SECTION III.—SERUM THERAPY.

Carasquilla was the first to attempt the preparation of an antiserum by inoculating large animals with the blood and serum of leper patients. Later, Laverde injected asses, lambs and horses with blood and serum from leprosy patients, with the juice of lepromata and even with the pulp of an epithelioma of the cervix uteri: the serum of the treated animals had a favourable influence on the course of the disease (10-20 c.c. were used for inoculation). Laverde's results were confirmed by Buzzi, Abraham, and Arning; Hallopeau, Neisser, and Brieger, however, failed to obtain similarly favourable results with the antiserum.

Metchnikoff and his pupils showed that the serum prepared by Laverde contained neither leprosy products nor toxin, but that the inoculation of serum, blood, or cellular elements of one animal into an animal of another species leads to the formation in the latter of substances (*cytotoxins*) which have the property of destroying the cells of the animal from which the material for inoculation was taken: and they demonstrated that the improvement noted in the lepers treated with Laverde's serum should be attributed to these cytotoxins. The inconstant results are explicable on the ground of the delicate nature of the cytotoxins, since these are destroyed by transport, the addition of carbolic acid, etc.

Metchnikoff and Bearedka inoculated a goat over a period of 36 days with 34 c.c. of defibrinated blood from a healthy man. The goat's serum acquired powerful

agglutinating and hæmolytic properties for human blood: a given volume of the serum agglutinated at once and dissolved in 7 minutes all the red cells in an equal volume of human blood.

When injected into lepers in doses of 1, 3, and 7 c.c. this serum to some extent relieved pain, and caused congestion and suppuration of some of the lepromata with the result that sloughs formed which afterwards became detached: in a few cases an insignificant febrile attack was noticed. In short, the results of using Metchnikoff's serum, although not so good, were very similar to those obtained with the serum prepared by Carasquilla, Laverde, and others.

In Metchnikoff's opinion the favourable results following the use of such serums should be attributed to the leucotoxin developed in response to the inoculation into the tissues of an animal of human leucocytic products; this leucotoxin should in suitable doses lead to stimulation of the leucocytic system: the hæmotoxin is of no therapeutic value, and indeed prevents the employment of sufficiently large doses of serum. The obvious conclusion from this argument is that in the treatment of leprosy an attempt should be made to prepare an antiserum by inoculating an animal with blood serum alone or better still with human lymphatic glands.

SECTION IV.—DETECTION AND IDENTIFICATION OF THE LEPROSY BACILLUS.

Microscopical examination is at present the only means of detecting the leprosy bacillus. Sections should be cut and films made of the suspected tissues and fluids. [Cultures should however be attempted.]

The bacillus of leprosy is found in the leprosy nodules, bone marrow, and spleen. The bacillus can also be found in the glands, in the swellings along the nerves, in the discharge from ulcerating lesions, in the saliva when the buccal mucous membrane is affected, in the stools when the disease infects the large intestine, in the secretion of the testicle when that organ is involved, in the milk (Babès), etc. Sticker has drawn attention to the presence of the bacillus in the nasal mucus. Nasal lesions are commonly present from the early stages of the disease and were found in 128 out of 153 lepers examined by Sticker; examination of films of the nasal mucus will therefore often afford confirmation of the diagnosis.¹

Leprosy nodules consist of large cells, similar to epithelioid cells, having as a rule a single nucleus and crammed full of bacilli: these constitute the lepra cells. The leprosy bacillus is therefore intra-cellular.

During life portions of a leprosy can be easily excised, since it is known that in the majority of these lesions there is an absence of all sensation. Manson recommends isolating a succulent leprosy in a pile clamp, slowly screwing up the jaws of the instrument so as to drive out the blood, pricking the now pallid leprosy and then collecting on a cover-glass the droplet of "leper juice" which exudes from the puncture.

Arning has never found the bacillus in the blood. According to Cornil, Babès and Goujerot the bacillus enters the blood stream a few days before death and especially during the febrile attacks.

The following technique is recommended for the detection of the bacillus:

(a) Stain films by Ziehl-Neelsen's method. The leprosy bacillus is differentiated from the tubercle bacillus by three tests—

1. Simple staining with a watery alcoholic solution of fuchsin;
2. Gram's stain;
3. Baumgarten's method of staining.

¹ In examining films of the nasal mucus care must be taken to distinguish the leprosy bacillus from the bacillus of Karlinski. The latter bacillus is found in the nasal mucus of man quite apart from leprosy or tuberculosis: it gives rise to no symptoms, morphologically resembles the bacillus of leprosy, and is acid-fast. In cultures, it grows easily on ordinary media, and is pathogenic to guinea-pigs when inoculated intra-peritoneally.

(b) Stain sections of tissues hardened in alcohol and embedded in paraffin by Ziehl-Neelsen's method : if necessary, the differential tests given above can be applied.

A good diagnostic point is afforded, as has been said, by the enormous numbers of bacilli to be seen in the lepra cells : tubercle cells never contain more than a few bacilli. Finally, the inoculation of a guinea-pig [will exclude tuberculosis].

Sub-cutaneous inoculation of tuberculin produces a reaction in persons suffering from leprosy while the ophthalmo-reaction is negative (Nicolle and Uriarti, Gaucher and Abrami).

Associated micro-organisms.

The lesions of leprosy being so frequently situated in the skin and mucous membranes or in the lungs are particularly liable to secondary infection.

Lesions of the skin and mucous membranes are very soon invaded by the ordinary organisms of suppuration (*staphylococci*, *bacillus pyocyaneus*, etc.). In the case of a leper in Tunis the author was able to demonstrate in the discharge from the specific lesions in addition to a few leprosy bacilli, *staphylococcus aureus*, *bacillus pyocyaneus* and *bacillus coli*. These organisms of secondary infection may invade the tissues in cases of leprosy and give rise to a rapidly fatal pyæmia (Babès).

Babès has frequently found the tubercle bacillus in persons suffering from leprosy, and the two organisms are frequently found in association especially in the lung : and in pulmonary lesions the pneumococcus may also be present.

In three cases of leprosy, Babès found as a secondary infection in the bone marrow, spleen, and kidneys, a bacillus which was easily cultivated outside the body and did not stain by Ehrlich's or Ziehl's methods.

CHAPTER XX.

BACILLUS DYSENTERIÆ EPIDEMICÆ.

Introduction.

Section I.—Experimental inoculation, p. 357.

1. Shiga bacillus, p. 357.
2. Flexner bacilli, p. 358.

Section II.—Morphology, p. 358.

1. Microscopical appearance and staining reactions, p. 358.
2. Cultural characteristics, p. 359.

Section III.—Biological properties, p. 359.

1. Biochemical reactions, p. 359.
2. Vitality, p. 360.
3. Toxin, p. 361.
4. Vaccination and serum therapy, p. 361.
5. Agglutination, p. 363.
6. Precipitins, p. 363.
7. Immune body, p. 363.

Section IV.—Detection, isolation and identification of the dysentery bacilli, p. 364.

- Serum diagnosis, p. 364.

The bacillus dysentericus El Tor No. 1, p. 365.

THE bacillus of epidemic dysentery was discovered by Chantemesse and Widal in 1888: Shiga amplified their observations and adduced additional evidence in proof of the specific relationship of the bacillus to the disease.

The term dysentery is applied to a clinical syndrome indicating certain lesions of the large intestine and ætiologically includes two distinct diseases, one caused by an amœba and the other by a bacillus. The former is an endemic disease of warm climates and is frequently complicated by abscess of the liver: the latter is an epidemic disease not complicated by abscess of the liver and prevalent both in warm and—especially—in temperate climates.

It is possible that in rare cases symptoms of dysentery may be due to certain other parasites which up till now have received little attention, such for example as *Balan-tidium coli*, *Spirilla*, or *Trichomonas*.

[Dysentery bacilli have been isolated from a number of cases of infantile diarrhœa (quite unrelated to any epidemic of dysentery) by Bassett and Duval in the United States; and in South Africa, Birt found dysentery bacilli in 7 out of 10 cases of this disease. In London, however, Morgan failed to find any bacilli of the dysentery group in cases of infantile diarrhœa.

[Asylum dysentery has been shown to be a bacillary dysentery and bacilli of the dysentery group have been isolated from cases of the disease in England, Germany and America (Eyre; Aveline, Boycott and W. F. Macdonald; Kruse; Vedder and Duval).

[Sporadic cases of dysentery are said to occur in England though rarely (Marshall; Bainbridge and Dudfield). Ledingham's investigations would appear to show that dysentery bacilli are occasionally found in the stools of healthy persons.]

In patients suffering from bacillary dysentery the organism is found in large numbers in the intestinal mucous membrane and in the stools especially in the mucous flakes. It does not become generalized, and with the

exception of one case recorded by Rosenthal the organism has never been found in the blood stream: according to some observers it is occasionally present in the mesenteric glands (Shiga, Duval and Bassett, [Aveline, Boycott and Macdonald]).

[Aveline, Boycott and Macdonald isolated the organism from the spleen in one out of three fatal cases of asylum dysentery.]

Several varieties of dysentery bacilli have been described, differing from one another in one or more particulars and especially in their action upon sugars. For practical purposes these varieties may be divided into two types: the Shiga-Krüse or non-mannite fermenting type and the Flexner or mannite fermenting type (see also p. 360).

Some authors regard the differences between these two types as sufficient to justify their classification as separate species. But it is held that these differences are not marked enough to warrant so complete a separation, and the view put forward by Gay and Duval which is perhaps of the nature of a compromise, commands general acceptance. These authors consider that the bacilli causing bacillary dysentery are to be regarded as belonging to a group of organisms exhibiting certain variations among themselves rather than as a single sharply-defined species. There is a similar multiplicity of varieties of the causal organism of cholera, as will be shown later.

The Shiga type of bacillus is the common cause of dysentery, and it will be therefore described at length in the following pages, the points of difference between it and the Flexner type being noted in the proper places. The general statement may here be made that all strains of Shiga's bacillus agree in their cultural and other characteristics, while under the title of Flexner's bacillus a number of very closely related though not absolutely identical organisms are included.

SECTION I.—EXPERIMENTAL INOCULATION.

Shiga bacillus.

Speaking generally, the Shiga type of bacillus is much more highly pathogenic to laboratory animals than are bacilli of the Flexner type.

Infection by the alimentary canal. *In man.*—Strong and Musgrave after administering some bi-carbonate of soda to a condemned criminal gave him a two-day-old broth culture of the dysentery bacillus. After an incubation period of 36 hours the man suffered from a typical attack of dysentery with blood-stained stools from which he made a rapid recovery. The bacillus was isolated from the stools.

In animals.—Infection of the alimentary canal whether by feeding or inoculation generally gives negative results (Rosenthal, Shiga, Conradi, and others).

After feeding guinea-pigs with dysentery bacilli, however, Chantemesse found lesions in the intestines similar to those seen in human dysentery; and Shiga, after introducing a culture into the stomach of a cat, noticed that it suffered from mucous diarrhoea and found the bacilli in increased numbers in the stools. Kazarinow introduced very large quantities of culture into the intestines of rabbits by means of an œsophageal sound, and *post mortem* found characteristic lesions in the intestine.

Intra-peritoneal inoculation.—Inoculation of dysentery bacilli into the peritoneal cavity is rapidly fatal to most animals. *Post mortem*, the peritoneal cavity contains a blood-stained serous exudate and the intestine is very markedly hyperæmic but presents none of the lesions characteristically seen in the human disease.

Intra-venous inoculation.—In the majority of animals death from septi-cæmia rapidly follows the inoculation of bacilli into the veins. *Post mortem*, the intestine is found to be slightly hyperæmic.

Sub-cutaneous inoculation.—The most interesting experimental results are obtained by inoculating animals sub-cutaneously: in rabbits, dogs, cats and young pigs such inoculation is followed by lesions similar to those found in the human subject. Guinea-pigs are less susceptible than other laboratory animals to this method of infection.

Rabbits.—Sub-cutaneous inoculation of 3–4 c.c. of a broth culture is fatal in 4–6 days.

Inoculation leads first of all to the formation of a large inflammatory œdema at the site of inoculation and this is soon followed by a rise of temperature and the onset of diarrhœa, then paralysis of the hind limbs appears and finally the temperature begins to fall and continues to decline steadily until death occurs. *Post mortem*, lesions are present throughout the alimentary canal being especially marked in the colon. In that portion of the intestine the mucous membrane is thickened, swollen, intensely hyperæmic and covered with blood-stained mucus; small foci of superficial necrosis and hæmorrhagic patches are also seen, the former occasionally ending in ulceration. The bacillus multiplies both in the mucus and in the mucous membrane where it is found in pure culture.

Dogs.—A “true representation of human dysentery with its painful and frequent strainings, characteristic stools and lesions” is seen in young dogs as a result of sub-cutaneous inoculation (Vaillard and Dopter).

Following the inoculation of one or two agar cultures, the temperature rises and an œdematous infiltration appears at the site of inoculation: the animal lies down, seems ill and is apparently in pain, and the motions become frequent and in character similar to those of human dysentery. These symptoms are followed by wasting and a fall of temperature to below normal, and death takes place between the third and sixth day. *Post mortem*, lesions similar to those described in the case of the rabbit are found in the intestine which is also extensively ulcerated, and the mesenteric glands are swollen. The bacillus is present in pure culture in the affected parts of the mucous membrane.

Young pigs.—Sub-cutaneous inoculation in these animals generally leads to a fatal attack of dysentery. *Post mortem*, lesions are found resembling those in the human disease.

Note.—After sub-cutaneous inoculation the bacillus can always be found in the local lesion at the site of inoculation and frequently also in the mesenteric glands, but only exceptionally in the spleen and liver and never in the blood of the heart.

Bacilli of the Flexner type.

Bacilli of the Flexner type are far less pathogenic than the Shiga bacillus. Intra-venous inoculation is not followed by severe symptoms and rarely leads to death in the case of dogs and rabbits: intra-peritoneal inoculation is more dangerous and produces a fatal peritonitis in guinea-pigs: feeding experiments give negative results. Sub-cutaneous inoculation is not followed by the symptoms and lesions of experimental dysentery and does not lead to a fatal result; after a marked local reaction the animal recovers.

SECTION II.—MORPHOLOGY.

1. Microscopical appearance.

The dysentery bacillus is a small rod-shaped organism morphologically like the colon bacillus; it measures 1–3 μ long. In cultures the organism is pleomorphic, and long almost filamentous forms are found side by side with very short bacilli. It does not form spores, and is non-flagellated and non-

motile, though it exhibits oscillatory movements which have been compared to those of a compass needle.

Staining reactions.—The dysentery bacillus stains with the ordinary basic aniline dyes, and with weak dyes tends to stain more deeply at the ends than in the centre. It is gram-negative.

Films should be stained with carbol-thionin or carbol-methylene-blue: sections with thionin or by Nicolle's tannin method (p. 217).

2. Cultural characteristics.

Conditions of growth.—The dysentery bacillus grows on all the ordinary alkaline media, and equally well under aerobic or anaerobic conditions. The optimum temperature is 37° C., though growth takes place within wide limits (10°–40° C.).

Characteristics of growth. Broth.—Growth is visible after incubating for 6 hours, and after 24 hours the medium is uniformly cloudy and has a watered-silk appearance. On further incubation a small glutinous deposit forms which continues to increase until towards the end of the second day, when the upper part of the broth is clear: no pellicle is formed on the surface. The cultures have a peculiar spermatic odour.

Gelatin.—The growth is like that of the typhoid bacillus. Isolated colonies are small, delicate and translucent with edges like the edges of a vine leaf. In stroke culture the growth consists of a thin narrow opalescent band. The medium is not liquefied.

Agar.—On agar the growth resembles that of the typhoid bacillus.

Potato.—The growth on potato consists of a moist, shiny glaze which is at first so scanty as to be hardly visible. Later it acquires a greyish or yellowish tint.

Milk.—Milk is not coagulated.

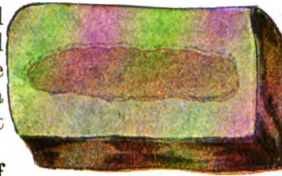

FIG. 215.—*Bacillus dysentericus*.
Potato culture, 6 days.

Bacilli of the Flexner type.

Cultures of bacilli of the Flexner type have the same characteristics as but are more luxuriant than those of the Shiga bacillus. In broth, after incubating for about 3 days a ring of growth adherent to the sides of the tube is formed on the surface of the medium; this falls to the bottom a few days later.

SECTION III.—BIOLOGICAL PROPERTIES.

1. Biochemical reactions.

Action on carbohydrates.—The Shiga bacillus does not ferment carbohydrates. The blue colour of litmus milk is unchanged, but litmus whey is slightly reddened at first becoming blue again about the second or third day. No gas is formed in litmus-lactose-broth. Neutral-red in glucose media is not reduced.

Bacilli of the Flexner type.—These bacilli ferment mannite and maltose but no other sugar [but see below]: litmus media containing mannite and maltose are turned red, but no gas is formed. In lactose media they behave like the Shiga bacillus.

[All strains of the Flexner or mannite-fermenting type apparently produce acid in mannite, glucose, galactose, arabinose, and raffinose: many ferment (acid, no gas) maltose and dextrin though not necessarily both, while a few

form acid in sorbite, inulin, salicin, and isodulcite. One strain of the Flexner type—apparently identical with the dysentery bacillus isolated by Strong—forms acid in dulcitate and cane sugar (Morgan).

[Hiss divided dysentery bacilli into four groups according to their fermentation reactions.

[The first or Shiga group ferments the monosaccharides and sometimes, after an interval of several days, maltose.

[The second group represented by Hiss' Y bacillus (isolated from dysenteric diarrhoea in children due to milk and identical with the bacillus found in cases of asyllum dysentery by Kruse and others) ferments the monosaccharides and mannite. Maltose and saccharose are sometimes also but with difficulty decomposed with the formation of acid.

[The third group consisting of Strong's Philippine bacillus ferments the monosaccharides, mannite and saccharose, occasionally also maltose.

[The fourth or Flexner (Manilla) group decomposes the monosaccharides, mannite maltose, saccharose and dextrin.

[To these Shiga subsequently added a fifth group; the characteristic of the organisms comprising it being that they give first of all an acid reaction in mannite, which subsequently changes to an alkaline reaction.

[Aveline, Boycott and Macdonald find that the fermentative reactions of the Flexner group towards maltose and cane sugar are variable. Thus, 24 cultures were tested with the result shown—

| | CANE SUGAR. | | | | MALTOSE. | | | |
|----------------------------|-------------|---|----|----|----------|---|----|----|
| Days incubated, - - - | 1 | 7 | 14 | 28 | 1 | 7 | 14 | 28 |
| Number of cultures acid, - | 0 | 0 | 1 | 4 | 2 | 3 | 13 | 24 |

[In litmus milk the mannite-fermenting bacilli first produce a slight acidity (1-3 days) and ultimately become alkaline (15 days). Strong's bacillus is the only strain which forms acid and clot (Morgan).]

Indol production.—The Shiga bacillus produces no indol in culture. Bacilli of the Flexner type vary, some strains produce indol, others do not. [According to Morgan the vast majority of the mannite-fermenting group form indol, some more freely than others.]

Growth in arsenical and carbolic broth.—All dysentery bacilli grow in broth containing carbolic acid (0.075 per cent.) or arsenious acid (0.1 per cent.).

Growth on vaccinated media.—On agar which has already served for the growth of the Shiga bacillus neither the Shiga bacillus nor the bacilli of the Flexner type will grow: the typhoid bacillus gives a very poor growth, the colon bacillus on the other hand grows abundantly.

Similar results are obtained with agar which has served for the growth of bacilli of the Flexner type.

On media which have served for the growth of the typhoid or colon bacillus neither the Shiga bacillus nor bacilli of the Flexner type grow.

2. Vitality.

The dysentery bacillus is a somewhat delicate organism. In culture it does not live for more than 3 or 4 weeks: in infected stools it appears to be quickly destroyed by the other micro-organisms present, and especially by the action of the colon bacillus, so that it cannot be isolated after 48 hours. Direct sunlight and desiccation rapidly destroy the bacillus: it is killed in less than an hour at 58° C.: and in sterile spring water at 20° C. it does not live more than 8-10 days. In water containing saprophytic organisms the larger the number of such organisms the more quickly does the dysentery bacillus disappear, and at the ordinary temperature it cannot be recovered after 2-10 days (Vincent); the higher the temperature also the more rapidly does the organism vanish: this may [partly] explain the frequency of epidemic dysentery in cold and temperate climates (Vincent).

3. Toxin.

(i) Filtered cultures of the dysentery bacillus are generally only slightly toxic, and even in large doses merely cause a temporary loss of weight; but the blood of the inoculated animal acquires the property of agglutinating the bacillus. Todd and Rosenthal however obtained a strong toxin, which was fatal to rabbits in doses of 0.2 c.c. sub-cutaneously, by growing the bacillus in Martin's broth at 37° C. for 3 weeks and then filtering. Their results have been confirmed by Ludke and Doerr.

(ii) Unfiltered cultures of the dysentery bacillus killed by heat (58° C. for 1 hour or 85° C. for 30 minutes) or chloroform, when inoculated into rabbits intra-peritoneally, intra-venously or sub-cutaneously, lead to a fatal result similar to that produced by the living organism and accompanied by diarrhoea and hyperæmia of the mucous membranes of the colon (Drigalski and Conradi).

(iii) **Endotoxin.**—Conradi, Neisser and Shiga, Vaillard and Dopter, and Besredka have extracted an intra-cellular toxin from the bodies of the bacilli.

Conradi's method.—Scrape the growth from an agar culture and make into an emulsion with normal saline solution. Place the emulsion in the incubator at 37° C. and leave for about 30 hours, then decant the clear liquid, filter through a Berkefeld bougie and finally evaporate *in vacuo* to one-tenth its original volume.

2. Neisser and Shiga's method.—Heat an emulsion of bacilli in normal saline solution to 60° C., allow to stand for 48 hours at 37° C. then filter through a Reichel filter.

3. Vaillard and Dopter's method.—Make a thick emulsion of bacilli from an agar culture with sterile water, heat to 58° C. for an hour, distribute in tubes, seal in the blow-pipe and leave in the warm (37° C.) incubator for a month. The clear supernatant liquid is used without filtration.

4. Besredka's method.—Besredka has applied his method of extracting endotoxin (p. 379) to the dysentery group. The endotoxin is very toxic and kills rabbits in doses of 0.05 c.c.

The Shiga bacillus alone produces dysentery toxin, bacilli of the Flexner type being almost invariably atoxic.

Properties of dysentery toxin.—The toxin kills dogs, rabbits and mice with all the symptoms of a dysentery infection. The fatal dose for rabbits varies according to the method of preparation and the method of inoculation (intra-peritoneal, intra-venous or sub-cutaneous) from 0.05 c.c. (with Besredka's endotoxin) to 2–5 c.c. Administered by the mouth it gives rise to no symptoms.

Dysentery toxin is less affected by heat than are many other toxins: it is, for instance, unaltered by being exposed to 70° C. for an hour, but a temperature of 75° C. weakens it and at 80° C. its properties are rapidly destroyed. It is now admitted that dysentery toxin is not a soluble or diffusible toxin but an endotoxin retained within the bodies of the bacilli.

4. Vaccination. Serum therapy.

(i) Shiga has shown that animals can be immunized by inoculating them sub-cutaneously with small doses first of dead bacilli then of living bacilli. The serum of immunized animals agglutinates the bacillus and has both prophylactic and curative properties.

Small animals are very difficult to immunize and it is therefore better to use a goat or an ass or an horse; horses must be treated very carefully.

The serums (ass and horse) obtained by Shiga and by Kruse protect guinea-

pigs against the inoculation of a fatal dose of bacilli and have powerful agglutinating properties (1-10,000). Good results have also been obtained in the treatment of human dysentery; with Shiga's serum the mortality was reduced two-thirds. The results with Martini and Lentz's goat serum and with Krauss and Doerr's serum (prepared by sub-cutaneous inoculation of living cultures) have not been so satisfactory.

(ii) Gay, who repeated and confirmed Shiga and Krüse's experiments, found that the agglutinating and prophylactic properties of dysentery-immunized horse serum were more marked with the strain used for immunization than with other strains. Independently of this Krauss and Doerr, thinking that their experiments showed that a Shiga immune serum had no action on bacilli of the Flexner type and conversely, recommended the preparation of a mixed Shiga-Flexner serum which could be given indifferently in all cases of dysentery whatever the infecting organism: acting on this suggestion, Coyne and Auché prepared a polyvalent serum which has yielded satisfactory results in the treatment of dysentery in man. Vaillard and Dopter however affirm that a Shiga-serum gives as good results in a Flexner as in a Shiga infection, and in consequence consider that polyvalent serums are unnecessary.

(iii) To obtain a serum which was both anti-bacterial and antitoxic Rosenthal immunized horses by inoculating them subcutaneously with toxin (p. 361) and living cultures simultaneously. The serum is both prophylactic and curative: it protects guinea-pigs in doses of 0.5 c.c., and in the treatment of human dysentery very good results have been obtained, especially by Korentchewsky in Manchuria where the mortality from dysentery fell by more than one-half.

(iv) Vaillard and Dopter, relying upon an observation by Besredka to the effect that in the case of endotoxic organisms the most active antisera were obtained when the bacilli are inoculated directly into the blood-stream, immunized horses by inoculating living cultures and toxin directly into the veins.

The process of immunization must be carried out very slowly. Virulent cultures of the Shiga bacillus were used and the toxin was prepared by Rosenthal's method (p. 361). Increasing doses of cultures were inoculated alternately with toxin, commencing with 0.25 c.c., then 0.5, 1, 2, 3 c.c., rising to 50 c.c., an amount which was never exceeded. The animals reacted violently (fever, prostration, temporary paralysis of the hind limbs, loss of weight). The serum was collected a fortnight to three weeks after the last inoculation.

Vaillard and Dopter's serum is both anti-bacterial and antitoxic. It protects rabbits when given in doses of 0.25-0.5 c.c., and leads to recovery (doses of 1-2 c.c.) even when administered 24 hours after the experimental infection. In doses of 20-100 c.c. it is very efficient in the treatment of human dysentery: the symptoms are alleviated almost at once, recovery is rapid and the mortality lowered more than three-fourths.

Vaccination in man.—Shiga tried to vaccinate men by inoculating them with a mixture of killed bacilli (80 parts) and serum (20 parts). The results were encouraging, but the immunity is only of short duration.

Immunity can be quickly produced by the inoculation of serum alone but does not last long (10-12 days).

In future experiments it would seem to be better to work with sensitized bacilli according to the technique of Besredka: emulsions of bacilli are killed by heat and agglutinated by a non-heated specific serum the excess of serum being removed by repeated washing and centrifuging (p. 382). Such a vaccine is only slightly toxic: in mice an immunity lasting 3-4 months is acquired in 4 days, and the susceptibility of the animals is not increased during the process of immunization.

5. Agglutination.

Shiga was the first to show that the serum of persons suffering from dysentery agglutinates the bacillus.

1. **Agglutinating properties of experimental serums.**—The serum of an immunized animal has the property of agglutinating the bacillus used for its immunization. The most highly agglutinating serums ($\frac{1}{2,000}$ — $\frac{1}{10,000}$) are obtained by inoculating animals intra-venously.

(a) The serum of normal animals has no action on the dysentery bacillus.

(β) Antidysentery serum is specific and has no agglutinating action on the typhoid, colon, or paratyphoid bacilli.

(γ) The serum of animals immunized with the Shiga bacillus agglutinates that organism but has no action on bacilli of the Flexner type.

(δ) The serum of animals immunized with bacilli of the Flexner type agglutinates these bacilli but not the Shiga bacillus.

[(ϵ) Hiss' Y bacillus is agglutinated by a Flexner serum but not by a Shiga serum. Strong's bacillus is agglutinated neither by a Shiga nor by a Flexner serum.]

2. **Agglutinating properties of the serum of persons suffering from dysentery.**—In testing the agglutinating properties of the serum of a dysentery patient it is important to recognize that the Shiga bacillus is only agglutinated in low dilutions (rarely in dilutions higher than $\frac{1}{10}$ — $\frac{1}{100}$) and that bacilli of the Flexner type are agglutinated in much higher dilutions ($\frac{1}{500}$) and may even be agglutinated by normal serums in low dilution.

(a) The serums of healthy persons [*exceptis excipiendis*] and of patients suffering from diseases other than dysentery do not agglutinate the dysentery bacilli.

(β) The serum of patients suffering from amoebic dysentery does not agglutinate the dysentery bacilli.

(γ) The serum of patients suffering from bacillary dysentery agglutinates the bacillus causing the infection and with rare exceptions has no action on the other type: the serum of a patient infected with the Shiga bacillus agglutinates the Shiga bacillus while having no action on bacilli of the Flexner type, and *vice versa*.

Whatever the type of bacillus causing the infection agglutination-capacity is present in the serum only in severe or averagely severe cases; it seldom appears before the end of the first week and occasionally not until later, but remains for several weeks after recovery.

(δ) The serums of dysentery patients never agglutinate the typhoid bacillus; but such a serum may agglutinate some varieties of the colon bacillus, the explanation being, possibly, that a colon bacillus infection has been superadded upon the original dysentery infection.

6. Precipitins.

If one drop of Shiga serum be added to ten drops of a filtered culture of the Shiga bacillus a precipitate is formed: a similar but less marked precipitate is also formed if instead of the Shiga culture, a culture of one of the bacilli of the Flexner type be used.

Conversely, Flexner serum precipitates filtered cultures of bacilli of the Flexner type and also but less markedly filtered cultures of the Shiga bacillus.

7. Immune body.

In the serum of persons suffering from dysentery and also in the serum of immunized animals a specific immune body is present which is fixed both

by the bacillus causing the infection and by all other types of dysentery bacilli. In human subjects the immune body makes its appearance about the fifth to the seventh day of the disease. It is quite distinct from the agglutinin and may be present in the serum before the latter.

SECTION IV.—DETECTION, ISOLATION AND IDENTIFICATION OF THE DYSENTERY BACILLUS.

To ensure the detection of the bacillus in a case of dysentery it is necessary to examine a recently evacuated stool. The bacilli are most numerous in the latter during the first week of the disease, but subsequently diminish in number, and finally disappear altogether as soon as the stools resume their normal consistency. Bacilli cannot be found in the stools after the twenty-first day of the disease (Rosenthal).

Dysentery bacilli may occasionally be found in the mesenteric glands and very exceptionally in other organs.

The bacilli cannot be differentiated by microscopical examination alone and cultures must be sown in every case.

Select a flake of sero-sanguinolent matter and after washing it thoroughly in sterile water emulsify in a little broth; use the emulsion for sowing gelatin or agar plates. Plates may also be sown by smearing the surface of the medium with one of the flakes after washing it. Should there be no mucous flakes dilute a trace of the stool in broth.

(i) Gelatin plates should be sown by the dilution method (p. 78) and incubated at 22° C. After 2 or 3 days the surface colonies are examined and any which resemble colonies of the dysentery bacillus picked off for further tests.

(ii) The best method is to use a lactose-agar medium—Chantemesse's (p. 407), Conradi-Drigalski's (p. 407), Endo's (p. 408) [or M'Conkey's (p. 412)].

Dip a fine sterile camel-hair brush in the broth emulsion and smear the surface of a number of plates of this medium without recharging the brush. It is perhaps even better to smear the surface of the medium with a washed mucous flake and spread the material with a Drigalski's spatula (p. 407). Incubate at 37° C. When examined after 20–24 hours colonies of the colon bacillus will appear as red spots, while those of the dysentery bacillus and of some other organisms will not have altered the colour of the medium. From among the latter pick off those which have a translucent iridescent appearance with irregular margins and the centres of which are rather more opaque than the edges, and sow them in broth and other media. Dysentery bacilli will be recognized by the absence of motility, by the cultural characteristics mentioned above and by their being agglutinated by a specific serum. [For purposes of identifying bacilli of the Flexner type the serum of an animal immunized with the Y bacillus is the most generally useful (Morgan).]

Serum diagnosis.

Since specific agglutinins are present in the serum of patients suffering from dysentery it is possible to make a diagnosis by the serum reaction.

Knowing that the serum of patients only agglutinates the bacillus which is causing the infection the serum must be tested both with a Shiga bacillus and with a Flexner bacillus. The reaction towards the Shiga bacillus should be tested in the first instance with a dilution of 1 in 20 or 1 in 30; a positive result under these conditions will be conclusive. The reaction towards bacilli of the Flexner type should be tested in a dilution of 1 in 80; agglutina

tion in a lower dilution cannot be accepted as evidence of a Flexner infection because, as has already been pointed out, normal serum in low dilution often has an agglutinating action on this type of the bacillus.

In dysentery, as in enteric fever, a positive reaction confirms the diagnosis : on the other hand if no reaction be obtained bacillary dysentery cannot be definitely excluded, because the blood may have been collected before agglutinins had developed.

[*Bacillus dysentericus* El Tor No. 1.¹]

This organism which was described by Armand Ruffer in 1909, was found to be the cause of the largest percentage of the cases of dysentery among the Mussulman pilgrims passing through the lazaret at El Tor: it has the characteristics of the dysentery group, but appears to differ from all the known sub-groups at present described. Ruffer, however, remarks that the name is merely provisional and that the bacillus may prove to be identical with one of the bacilli already described.

Morphology.—The bacillus Tor No. 1 is similar to, but plumper than, the Shiga bacillus; filaments were rarely seen; no spores were found nor could cilia be demonstrated. It showed movement of spiral rotation when freshly isolated but no movement of progression: in sub-cultures it was quite motionless.

Cultures.—Broth.—Uniform turbidity: no pellicle.

Gelatin.—Not liquefied. The colonies have no vine-leaf appearance like those of the Shiga bacillus.

Agar.—Similar to typhoid.

On Endo's medium.—Colourless.

On Conradi-Drigalski's agar.—Like typhoid.

Bio-chemical reactions.—*B. dysentericus* Tor No. 1 formed acid out of mannite and thus resembled Flexner's bacillus. In saccharose, maltose, salicin, sorbite, dulcite and dextrin reactions were very inconstant and differed with different strains of the bacillus.

A small amount of indol was formed sometimes but the reaction was not constant.

In milk, no clot was formed.

In litmus milk most strains produced first an acid reaction followed by a stage of increased alkalinity. One of the strains however produced a permanent acidity.

Pathogenicity.—The *B. dysentericus* Tor No. 1 was highly pathogenic to rabbits on intra-peritoneal or intra-venous inoculation, giving rise to fever, diarrhoea and paralysis and causing death in 24 hours to 5 days according to the dose inoculated. The pathogenicity for rabbits rapidly disappeared in sub-cultures.

Guinea-pigs were even more susceptible than rabbits. The symptoms and lesions were the same as in the rabbit.

In horses inoculation of sterilized cultures produced a wide-spread oedema about the site of inoculation, rise of temperature and a general condition of ill-health.

In man the clinical signs and pathological appearances were indistinguishable from those produced by infection with the Shiga bacillus.

Toxin.—None of the cultures of this organism gave a soluble toxin.

Agglutination.—The serum of patients suffering from a Tor No. 1 infection did not agglutinate the Shiga bacillus but agglutinated bacillus Tor No. 1 constantly except in early acute cases or in very feeble old people. The dilution in which agglutination could be obtained varied from 1 in 25 to 1 in 300, the index rising during convalescence.

With the serum of animals specifically immunized it was found that the Tor bacillus was agglutinated in dilutions of 1-1000 to 1-2000 with a Tor serum, while with a Shiga serum agglutination was inconstant in a dilution of 1-100, and with a Flexner serum agglutination was effected with a dilution of 1-200 but not with a dilution of 1-500.

Serum therapy.—Ruffer found that patients suffering from a Tor infection were not benefited by treatment with a Shiga serum while severe cases were quickly cured by inoculation with the serum of an horse immunized with *B. dysentericus* Tor No. 1.

[¹ This section has been added.]

CHAPTER XXI.

BACILLUS FEBRIS ENTERICÆ.

Introduction.

Section I.—Experimental inoculation, p. 367.

A. Inoculation of viruses of ordinary virulence, p. 368. B. Inoculation of viruses of exalted virulence.—Methods of increasing virulence.—Infection with viruses of exalted virulence, p. 368. C. Infection by the alimentary canal, p. 369.

Section II.—Morphology, p. 370.

1. Microscopical appearance and staining reactions, p. 370. 2. Cultural characteristics, p. 371.

Section III.—Biological properties, p. 373.

1. Bio-chemical reactions, p. 373. 2. Variability of flagella, p. 376. 3. Viability and virulence, p. 376. 4. Toxins, p. 376. 5. Vaccination, p. 380. 6. Serum-therapy, p. 383. 7. Agglutination and the serum diagnosis of enteric fever, p. 384. 8. Absorption of agglutinins, p. 389. 9. Complement fixation, p. 390.

Section IV.—Detection, isolation and identification of the typhoid bacillus, p. 390.

THE causal organism of enteric fever was originally discovered by Eberth in the spleen, lymphatic glands and Peyer's patches of persons suffering from the disease. Its morphological characteristics were more fully described by Gaffky.

The bacillus of enteric fever¹ is always present in the spleen, liver, mesenteric glands, glandular follicles of the intestine and bone marrow and less frequently in the lungs, meninges, testicles, tonsils, etc. A certain number of cases of enteric fever have been recorded in which there was no intestinal localization.

For a long time it was thought that the bacillus did not pass into the blood stream (Chantemesse and Widal, and others). It is, however, now recognized that the failure to find the bacillus in the blood was due to the defective technique then employed and that, as a matter of fact, in enteric fever the bacillus does pass into the blood stream and that the disease is in reality a true septicæmia. In all cases of moderate and severe infection the organism can be isolated from the blood from the fifth day until the end of the third week of the disease (Courmont).

The bacillus can often be isolated from blood taken from the rose spots (Thiemisch and Neuhaus, Besson, etc.).

Rémy's experiments have proved that, contrary to the opinion formerly held, the bacillus is present in the stools of enteric fever patients as early as the third day of the disease and before ulceration of the intestine has begun. The number of organisms present in the stools increases until the end of the first week and then gradually diminishes until at the end of the fourth week they can as a rule no longer be found. The bacilli have, however, been isolated from the stools of persons who have recovered from the disease for more than a month (Rémy, Chantemesse and Decobert) and it will be shown later that in some cases they persist for a still longer period.

¹ In the remainder of the chapter and elsewhere the organism is termed for the sake of convenience the typhoid bacillus.

The bacillus also sometimes passes into the urine of enteric fever patients. Besson from an examination of thirty-three cases came to the conclusion that the bacillus was only present when there was albumin in the urine and found it in 40 per cent. of such cases: the bacillus disappears synchronously with the disappearance of the albumin. Vincent found the bacillus in the urine in about 1 case in 5 of enteric fever; he noticed that occasionally the bacillus remained in the urine after the patient had recovered, and considered that under those conditions the organism multiplied in the bladder. Horton Smith showed that the bacillus may set up slight cystitis with pyuria.

The bacillus is also the cause of many of the complications of enteric fever, such for instance as inflammation of the fauces, naso-pharynx and larynx, broncho-pneumonia and various suppurative affections: deep seated abscesses, osteitis, adenitis, pleurisy, pericarditis, etc. It may also become localized in lesions existing before the onset of the infection. Widal observed instances of this in a case of ovarian cyst and in a case of tuberculous adenitis.

Chantemesse was the first to put forward the opinion afterwards supported by Remlinger and Schneider that the typhoid bacillus might live a saprophytic existence in the intestines of healthy persons. The investigations of Rémy and others, however, seem to prove that the bacillus is only found as a saprophyte in the intestines of those who have recently been either in contact with cases of the disease or in some other way exposed to infection. But further, in a certain percentage (according to Schneider, 3 per cent.) of patients who have recovered from the disease, and especially in women, the bacillus may remain for several months and even years: it is said to take up its abode principally in the gall bladder from whence it is discharged into the intestine. It is easy to appreciate the prominent part which such "carriers," to use Drigalski and Conradi's expression, may take in the dissemination of enteric fever.

The bacillus has been frequently found in drinking water and in ice destined for human consumption. Wherever enteric fever is epidemic the drinking water should be examined for the presence of the typhoid bacillus.

The organism has also been isolated from soil and from the dust of wards in which cases of enteric fever have been nursed, etc.

The attention of observers has been drawn to the part which flies may possibly play in the propagation of the disease. During an epidemic of enteric fever at Chicago, Mrs. Hamilton on several occasions obtained cultures of the typhoid bacillus by sowing flies which had been caught in water-closets, enteric wards, etc. Ficker has shown that flies which have been in contact with cultures of the typhoid bacillus may specifically contaminate objects on which they settle even as long as 23 days afterwards.

The typhoid bacillus and the colon bacillus are in many ways very like one another and both have their usual habitat in the intestines of man and the lower animals. The analogies which undoubtedly exist between these two organisms have led some observers to express the opinion that they are identical. This view however has not met with general acceptance and it is now clear that the colon bacillus and the bacillus of enteric fever have each their own characteristic properties and are in fact two distinct though closely related species

SECTION I.—EXPERIMENTAL INOCULATION.

The lower animals are not naturally susceptible to enteric fever. The inoculation of laboratory cultures is in most cases without result; some observers indeed have noticed symptoms of intoxication in guinea-pigs, rabbits and mice, but they have not been able to produce a generalization of the bacillus. If, however, a virus of increased virulence be inoculated these

animals die with the lesions of septicæmia. In monkeys and rabbits typical attacks of enteric fever have been induced by feeding with typhoid bacilli.

A. Inoculation of viruses of ordinary virulence.—Even cultures which have been sown with material direct from a case of enteric fever do not as a rule lead to a generalized infection in the lower animals, though occasionally guinea-pigs and mice can be infected by inoculating them in the peritoneal cavity. Sub-cutaneous inoculation generally results in the formation of a small abscess at the site of inoculation from which the animal rapidly recovers.

In rabbits, guinea-pigs and dogs, intra-cranial inoculation of a small amount (0.05–0.1 c.c.) of a fifteen- or twenty-day old culture gives rise, by reason of the toxin it contains, to severe symptoms which terminate fatally. The inoculation of young cultures produces nothing more than a transitory illness (Vincent).

B. Inoculation of viruses of exalted virulence.—Sanarelli, Chantemesse and Widal and others have succeeded in increasing the virulence of typhoid bacilli and with these exalted viruses they can always be certain of producing a typhoid septicæmia in laboratory animals.

Methods of increasing virulence.—(a) Sanarelli inoculated 5 c.c. of a twenty-four-hour old broth culture of a typhoid bacillus of ordinary virulence into the cellular tissue of a guinea-pig and at the same time into the peritoneal cavity 10 c.c. of an old sterilized broth culture of the colon bacillus: death supervened in about 20 hours and *post mortem* the typhoid bacillus was found in the peritoneal cavity and occasionally also in the spleen and blood.

A little of the peritoneal exudate from this animal was then sown on broth and it was found that 5 c.c. of the broth culture sub-cutaneously inoculated into a second guinea-pig would kill the animal if, at the same time, 7–8 c.c. of a sterilized culture of the colon bacillus were inoculated intra-peritoneally. By thus passing the bacillus through a series of animals diminishing at each inoculation the dose of colon bacillus culture, it happened that after a short time a strain of the typhoid bacillus was recovered which could, unaided by the simultaneous inoculation of the colon bacillus, lead to an enteric infection in rabbits and guinea-pigs when inoculated sub-cutaneously in doses of 5 c.c.

Similar results were obtained by Sanarelli if instead of the colon bacillus he inoculated sterilized cultures of *Proteus vulgaris*, sterilized cultures of stools, or an infusion of meat a month old sterilized at 120° C. By simply feeding guinea-pigs with small quantities of this infusion he was able to secure the generalization of a typhoid bacillus which before had no pathogenicity for the guinea-pig.

In the case of a virus which is fatal to guinea-pigs in large doses the virulence may be raised by passage intra-peritoneally through guinea-pigs. For this purpose 2 or 3 c.c. of a peritoneal exudate rich in bacilli are inoculated in the first instance, then, as the virulence increases, as evidenced by the fact that the animals die in a shorter space of time and by the diminished quantity of exudate found *post mortem*, the quantity injected is gradually reduced to 0.5 and 0.1 c.c. After fifteen to twenty such passages a single drop is sufficient to kill an adult guinea-pig in 12 hours. After the thirtieth passage the virulence is fixed and cannot be further increased. A few drops of a twenty-four-hour old broth culture of the "fixed virus" is sufficient to kill susceptible animals on intra-peritoneal inoculation. If inoculated sub-cutaneously much larger doses must, however, be employed: thus, for instance, in the case of rabbits and guinea-pigs 1–4 c.c. and for mice 0.5 c.c. are necessary.

Note.—In attempting to raise the virulence of an organism by passage through the peritoneal cavities of guinea-pigs it is important to utilize the peritoneal exudate itself for the successive inoculations and not cultures sown from the exudates. To

maintain the virulence after exaltation the organism should be grown on a broth which before sterilization turns phenol-phthaleïn pink and to which a few drops of guinea-pig blood have been added just before sowing it (Rodet and Lagriffoul).

(b) Chantemesse and Widal also raised the virulence of bacilli moderately virulent [for experimental animals] by passage through guinea-pigs, utilizing to that end a discovery of Vincent relative to the exaltation of the typhoid bacillus when associated with sterile cultures of streptococcus pyogenes. They inoculated into the cellular tissues of a guinea-pig 4 c.c. of a culture of a typhoid bacillus and at the same time into the peritoneal cavity 8–10 c.c. of a culture of a pyogenic streptococcus which had been sterilized at 100° C. for 1 hour. The animal died in less than 24 hours and the typhoid bacillus was found to have become generalized. The organism was passed through a series of guinea-pigs and the dose of sterilized streptococcus emulsion gradually diminished, with the result that the typhoid bacillus soon became so virulent that a few drops introduced into the peritoneal cavity caused the death of the animal.

(c) According to Chantemesse and Balthazard the most efficient method of raising the virulence of a typhoid bacillus to a maximum is to sow a culture in a collodion sac, and after leaving it in the peritoneal cavity of a guinea-pig for 24–36 hours to sow the contents in broth: the growth is very abundant so that in 12 hours the surface is covered with a thick pellicle. This culture is fully virulent.

Infection with viruses of exalted virulence.—Guinea-pigs are the best animals for the study of typhoid infections. A few drops of an exalted virus inoculated into the peritoneal cavity gives rise to a typical attack of the disease.

Two to four hours after inoculation the temperature rises and may reach 41° C. but it soon (6–12 hours) begins to fall to 36° C. and perhaps 32° C.; synchronously with the fall of temperature collapse sets in and the animal dies 15–30 hours after the inoculation.

During the febrile period the animal is dull and refuses its food. When the temperature has become subnormal it huddles itself up in a corner of its cage, the abdomen is painful and the animal rapidly wastes.

Post mortem examination. The peritoneal cavity is found to contain a variable amount of an opalescent serous fluid very rich in bacilli (the greater the virulence of the organism the less the effusion): the spleen, liver, kidneys, intestines and notably the Peyer's patches are swollen and congested: the mesenteric glands are swollen and in some cases there is a little pleural effusion: the intestine contains a serous fluid rich in bacilli. According to Chantemesse and Widal these latter are typhoid bacilli but according to Sanarelli they are very virulent colon bacilli.

The organism is found in pure culture in the peritoneal exudate and also in the internal organs, blood etc.

C. Infection by the alimentary canal. 1. Monkeys.—Chantemesse and Ramond fed a *Macacus rhesus* for a fortnight on an exclusively milk diet and then gave it a virulent agar culture of the typhoid bacillus mixed with jam. As early as the third day the animal experienced a rise of temperature, anorexia and diarrhoea, and was dead at the end of a week. *Post mortem* examination revealed lesions characteristic of human enteric fever especially in the neighbourhood of Peyer's patches.

2. Rabbits.—Remlinger succeeded in infecting rabbits by starving them for 2 or 3 days and then feeding them for 5–10 days on vegetables contaminated with cultures of the typhoid bacillus. Many of the animals remained

unaffected but a few of them towards the end of the first week had a rise of temperature, became emaciated, suffered from diarrhoea and eventually died. *Post mortem* examination showed ulceration of Peyer's patches, enlargement of the spleen, etc. The typhoid bacillus was recovered in pure culture from the spleen.

Chantemesse and Ramond lowered the resistance of rabbits by injecting into the peritoneal cavity some sterile broth containing 50 drops of laudanum and then a quarter-of-an-hour later introduced into the stomach by means of a tube 5 c.c. of a young broth culture of the typhoid bacillus. Animals so treated became infected with a true enteric fever; they developed the characteristic lesions, and their serum agglutinated the bacillus.

By daily inoculation with human blood serum or urine for a period of 3 weeks animals can be rendered more susceptible to infection with the typhoid bacillus.

SECTION II.—MORPHOLOGY.

1. Microscopical appearance.

The typhoid bacillus occurs in the tissues as a short rod measuring about 2–3 μ long and 0.6–0.7 μ broad.

In cultures its length and breadth vary within wide limits. In broth, for example, the bacillus is shorter and more slender; in old gelatin cultures, it is elongated and shows filamentous forms; on agar and potato it is broader and shorter and has a squat appearance.

The bacilli both in tissues and cultures occur singly or joined together in pairs, and in young cultures they not infrequently look like diplococci.

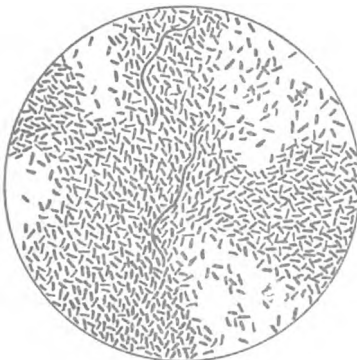

FIG. 216.—Film preparation of the typhoid bacillus from a gelatin culture. Carbol-fuchsin. (Oc. 2, obj. $\frac{1}{4}$ th, Zeiss.)

The ends of the bacilli are rounded. The protoplasm stains uniformly, but occasionally, in old cultures, the bacilli are somewhat swollen about their centres and show a clear space of variable size—"the shuttle form" of Artaud. This unstained portion does not represent spore formation any more than do the terminal swellings which are sometimes seen in cultures of the bacillus and which are merely degeneration forms.

As a rule, the typhoid bacillus is very motile and moves rapidly across the field of the microscope like fish in water, but some strains of the bacillus are only slightly motile. The motility is due to the presence of flagella (*vide infra*).

If a trace of growth from a solid medium be placed in a drop of water the bacilli separate one from another and the water is immediately rendered turbid (Chantemesse).

Staining reactions.—The typhoid bacillus stains readily with the basic aniline dyes and is gram-negative.

Staining of flagella.—The flagella may be easily stained (p. 149). Van Ermengem's or Nicolle's method is recommended as giving the best results.

In stained films the number and arrangement of the flagella can be readily made out. As a rule, each bacillus has eight to a dozen flagella, but it is not at all uncommon for individual bacilli to have as many as eighteen to twenty-four. Flagella which have been inadvertently torn away from

their bacilli during the necessary manipulations will be found in every preparation.

The flagella are normally implanted regularly around the body of the organism [peritrichous] though now and again they are found arranged in tufts probably from the dragging of the surrounding liquid on these highly delicate structures. The bacilli are often agglutinated into clumps by a matrix which stains in the same manner as the flagella and it is upon this matrix that the flagella appear to be implanted.

The flagella vary in length, the average being $6-8\mu$ (Rémy and Sugg); but much longer forms are to be seen. They are wavy in form and present three to eight undulations.

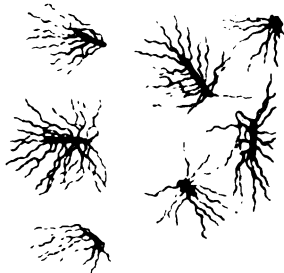

FIG. 217.—Typhoid bacillus stained to demonstrate flagella. $\times 1000$.

2. Cultural characteristics.

A. Conditions of growth.—The typhoid bacillus is a facultative aërobie. It grows on all the ordinary media within a wide range of temperature (4° – 46° C.) the optimum being 30° – 37° C. Cultures of the typhoid bacillus have no smell.

B. Characters of growth on various media. 1. **Broth.**—After 8–12 hours' incubation at 37° C. the medium shows a slight cloudiness, which as the growth progresses becomes more marked, and gives to the culture when examined by transmitted light a characteristic watered-silk appearance: this may be made more distinct by gently shaking the tube: later the growth becomes flocculent, falls to the bottom of the tube, and forms a very abundant sediment. Ultimately the liquid becomes clear and develops a brownish colour.

2. **Gelatin.**—The typhoid bacillus does not liquefy gelatin.

Stab culture.—At 20° C. growth along the line of the stab commences as early as the second day in the form of small, round, yellowish-white confluent colonies, while on the surface a thin, transparent, rather spread-out disc with iridescent margins appears; occasionally the surface growth is represented by a thick opaque spot of very limited extent. Growth is always scanty.

Stroke culture.—On the surface along the line of sowing the growth forms a thin transparent film with irregular margins and shot with iridescent colours; it always remains scanty and ceases to increase after the first week. Such is the usual appearance, but sometimes a narrow, thick, opaque, yellowish-white band develops along the stroke.

In the substance of the gelatin long arborescent crystals are sometimes seen. These are due to the precipitation of phosphates.

FIG. 218.—Typhoid bacillus. Photograph of a colony growing in plate culture (6 days). $\times 60$.

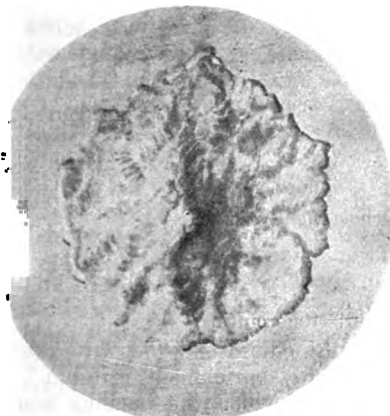

Single colonies.—Isolated colonies on gelatin usually but not invariably present a characteristic appearance.

After incubating at 20° C. for 48 hours, small circular colonies appear and soon reach the size of a pin's head and later that of a lentil, but always remain thin, bluish in colour, pearly and

transparent: the edges of each colony become indented and sinuous, and at the same time ridges extend from them into the centre, which becomes thicker than the margins. These details may be made out clearly with a lens. The general appearance has been compared by German writers to an iceberg.

Colonies developing in the depth of the gelatin and sometimes even those on the surface have quite a different appearance. They are round and opaque, and remain about the size of a pin's head.

3. Agar: Coagulated serum.—There is nothing characteristic about the growth on these media. After incubating for 24 hours at 37° C. a whitish streak appears, which subsequently becomes thicker and cream-coloured. Glycerin-agar yields a more copious growth.

4. Potato.—The growth of the typhoid bacillus on potato is as a rule characteristic. At first sight there appears to be no growth at all: but on illuminating the surface of the potato by daylight a delicate, moist, shiny deposit like the icing on cakes is seen along the line of sowing. Sometimes the culture assumes a bistre tint later.

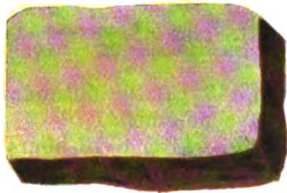

FIG. 219.—Typhoid bacillus. Culture on potato.

In some cases however the growth on potato is plainly visible, being yellowish in colour and occasionally even definitely brownish. Buchner states that this appearance can be obtained at will by making the potato alkaline with a solution of carbonate of soda.

5. Rémy and Sugg's medium.—To avoid complications induced by variations in the chemical composition of potato, an artificial medium has been prepared by Rémy and Sugg which contains the constituent ingredients of potato. According to the authors the typhoid bacillus on this medium invariably gives a characteristic growth; "a limited, absolutely colourless, scalloped film."

The medium is prepared as follows.

(a) Make a solution containing:—

| | |
|--|------------|
| Water, - - - - - | 1000 c.c. |
| Glucose, - - - - - | 20 grams. |
| Peptone, - - - - - | 5 " |
| Asparagin, - - - - - | 5 " |
| Citric acid, - - - - - | 0.75 gram. |
| Neutral potassium phosphate, - - - - - | 5 grams. |
| Magnesium sulphate, - - - - - | 2.5 " |
| Potassium sulphate, - - - - - | 2.5 " |
| Sodium chloride, - - - - - | 1.25 " |
| Carbonate of sodium <i>q.s.</i> to render the whole slightly alkaline. | |

(b) To 100 c.c. of this solution add:—

| | |
|------------------------------------|-----------|
| Gelatin (extra quality), - - - - - | 10 grams. |
| Calcined magnesia, - - - - - | 2 " |

Distribute in tubes, sterilize, slope. Sow in stroke culture.

6. Bile.—Sterilized ox-bile is a very useful medium on which to grow the typhoid bacillus (Conradi). It is used as an "enrichment medium" for obtaining [primary] cultures from material in which the bacillus is only present in small numbers, as for example the blood of enteric fever patients (p. 391. 2 (δ)).

7. Milk.—The bacillus grows abundantly in milk without coagulating the medium.

SECTION III.—BIOLOGICAL PROPERTIES.

The difficulty of distinguishing the typhoid from the colon bacillus has rendered necessary a close study of the biological properties of the two organisms: the morphological characteristics alone are insufficient to allow of their differentiation.

1. Biochemical reactions.¹

Action on carbohydrates.—The typhoid bacillus has a distinct action [acid without apparent gas] upon glucose, [maltose, sorbite and mannite] and also acts feebly upon lævulose and galactose, but ferments neither saccharose, lactose, [dulcitate, raffinose, arabinose, erythrite, salicin, amygdalin nor inulin].

These properties furnish valuable data for the recognition of the organism, and the methods of demonstrating them will now be considered.

(a) Sow the bacillus in a tube of lactose-broth to which a little carbonate of lime has been added (p. 35). No gas is formed however long the culture be incubated.

(b) Sow on litmus-lactose-gelatin (p. 57): the typhoid bacillus does not attack either mannite or lactose so that no acid is formed and the medium retains its blue colour (cf. *Bacillus coli*).

(c) Sow in Grimbert and Legros' medium. This medium has the following composition:—

| | | | | | | | | | |
|----------------------------|---|---|---|---|---|---|---|------|--------|
| Lactose (chemically pure), | - | - | - | - | - | - | - | 20 | grams. |
| Peptone, | - | - | - | - | - | - | - | 5 | " |
| Distilled water, | - | - | - | - | - | - | - | 1000 | c.c." |

Dissolve by boiling: add a little pure carbonate of lime: shake: leave for 5 minutes: filter: test the reaction, which should be neutral. Sterilize by filtering through a Chamberland bougie. Distribute into tubes and add sufficient sterilized litmus solution (p. 56).

After sowing with the typhoid bacillus and incubating, the medium retains its blue colour.

(d) Sow in milk.—The milk is not coagulated and if a little litmus solution be added its colour remains unchanged.

[A definite acidity is produced in the first 24 hours but this is subsequently neutralized and the medium ultimately becomes distinctly alkaline, though the time occupied in the production of an alkaline reaction varies considerably with different strains—in some cases a month may elapse before the medium is definitely alkaline.]

For these tests the milk should always be sterilized at the same known temperature: some contaminating organisms which easily coagulate milk which has been sterilized at 100° C. coagulate it more slowly and with more difficulty if it has been exposed to higher temperatures, and mistaken diagnosis may result if this fact has not been recognized (see also p. 57).

These reactions are sufficient to enable the typhoid bacillus to be distinguished from the colon bacillus (p. 393). When it is necessary to make a differential diagnosis between the typhoid and colon bacilli glucose should never be used as the fermentable agent since the typhoid bacillus has a distinct action on it.

Non-production of indol.—The typhoid bacillus never produces indol in cultures.

¹ Here the nature of the reactions will be briefly stated; their application to the differentiation of the typhoid and colon bacilli will form the subject of a special chapter (xxiii.).

Tests for indol.—To determine whether an organism produces indol or not, a solution of peptone must be used and not ordinary broth. The following is a medium often used for this test :—

| | | | | | |
|--|---|---|---|---|----------------|
| Water, | - | - | - | - | 100 c.c. |
| Witte's, Chapoteaut's or Byla's peptone, | - | - | - | - | 2 grams. |
| Sodium chloride, | - | - | - | - | 0.5 to 1 gram. |

Tube in quantities of about 15 c.c. and autoclave.

After sowing, incubate for 2-3 days and apply one or other of the following tests :—

(a) **Salkowski's reaction.**—To the culture in peptone water add 1 c.c. of a 0.2 per cent. solution of potassium nitrite, then, slowly, 1 c.c. of a 25 per cent. solution of chemically pure sulphuric acid in water. If indol be present a rose tint appears.

Nonotte and Demanche find that the reaction is more delicate in the warm. To a peptone-water culture add 1 c.c. of a 1 in 1000 solution of nitrite of potassium and 8 drops of pure concentrated sulphuric acid and boil the upper part of the liquid. If indol be present a very distinct pink colour appears even when the amount of indol does not exceed 1 part in 4 millions : in the cold, the reaction only takes place if the amount of indol exceeds 1 part in 75,000.

(b) **Weyl-Legal's reaction.**—To the culture add 5 to 10 drops of a 5 per cent. solution of sodium nitro-prusside then a few drops of a 30 per cent. solution of washing soda. The solution turns brown. After a few minutes add 10 to 15 drops of glacial acetic acid ; if indol be present a characteristic blue colour appears but often only after some delay.

(c) **Nencki's reaction.**—To the culture add first a few drops of glacial acetic acid then 2-3 c.c. of alcohol-ether : shake and allow to stand until the ether rises : decant the layer of ether and evaporate it in a porcelain dish. To the residue add 1 to 2 drops of a 0.2 per cent. solution of potassium nitrite and a few drops of pure sulphuric acid. This method is very delicate and the least trace of indol is shown by the appearance of a rose pink colour.

(d) **Fleig's reaction.**—To 10 c.c. of culture add 10 c.c. of a 1 in 50 alcoholic solution of furfural, then pure hydrochloric acid drop by drop. If indol be present the solution turns yellow. This method is very delicate.

(e) **The para-dimethyl-amido-benzaldehyde test. Recommended.**—Prepare two solutions :

Solution I.—

| | | | | | |
|-----------------------------------|---|---|---|---|----------|
| Para-dimethyl-amido-benzaldehyde, | - | - | - | - | 4 parts. |
| Absolute alcohol, | - | - | - | - | 380 " |
| Concentrated hydrochloric acid, | - | - | - | - | 80 " |

Solution II.—

Saturated aqueous solution of potassium persulphate.

[To about 10 c.c. of the broth or peptone-water culture of the organism add 5 c.c. of Solution I. and then 5 c.c. of Solution II., shake the mixture and the presence of indol is indicated by the appearance, in a very short time, of a red colour, which gradually becomes darker on standing. The reaction may be accelerated by heating the mixture.]

Some peptones contain a trace of indol and to avoid all possibility of mistake Siere recommends using a 1 per cent. solution of Byla's peptone and when testing for indol to test at the same time a tube of sterilized peptone-water as a control.

Growth on Synthetic media.—A number of synthetic media have been prepared on which the typhoid bacillus grows slowly and feebly while closely related organisms with which it may be confused grow freely.

Too much importance should not be attached to the differentiating function of these media, but, generally speaking, if growth be absent or delayed on any one of

them, this is an indication sufficiently reliable to justify a suspicion of the presence of the typhoid bacillus.

For choice, the following medium, composed by Rémy and Sugg, may be used :—

| | | | | | | | | |
|---------------------------------|---|---|---|---|---|---|------|--------|
| Distilled water, | - | - | - | - | - | - | 1000 | c.c. |
| Glucose, | - | - | - | - | - | - | 20 | grams. |
| Nitrate of soda, | - | - | - | - | - | - | 10 | „ |
| Magnesium sulphate, | - | - | - | - | - | - | 2 | „ |
| Neutral phosphate of potassium, | - | - | - | - | - | - | 1 | gram. |
| Calcium chloride, | - | - | - | - | - | - | 1 | „ |

Inability to grow on "vaccinated" media.—Chantemesse and Widal have demonstrated the following curious property of the typhoid bacillus. If a tube of agar or gelatin be sown with the bacillus and after incubation the growth be scraped off and the medium resown with the organism the second sowing remains unfertile on incubation, the medium having been, as it were, "vaccinated" by the first growth. Unfortunately this phenomenon sometimes fails and taken alone is not a reliable test. The colon bacillus also frequently fails to grow on a medium which has been used for the growth of the typhoid bacillus.

Growth on coloured media.—D'Abundo; Nøggerath; and also Gasser have drawn attention to the property possessed by the typhoid bacillus of decolorizing during growth media stained with certain dyes.

Nøggerath's medium (p. 57) was recommended by its discoverer and later by Deschamps and Grancher as a diagnostic agent for the typhoid bacillus. When sown on the surface of gelatin plates coloured with Nøggerath's fluid, the typhoid bacillus gives rise to colonies of a purple colour while the surrounding medium becomes decolorized.

Gasser, recognizing that Nøggerath's medium gives inconstant results, substituted fuchsin-agar (p. 57). The typhoid bacillus sown on this medium and incubated at 37°–39° C. for 2 days gives red colonies, the surrounding medium being decolorized.

These reactions are unfortunately not constant and cannot be relied upon for the purpose of recognizing the typhoid bacillus.

Growth on arsenical broth.—Thionot and Brouardel found that the typhoid bacillus does not grow in broth containing arsenious acid to the extent of 0·02 gram per litre, while the colon bacillus grows not only in this medium but also when the broth contains as much as 1–2 grams of arsenious acid per litre.

Growth on artichoke.—According to Roget, the typhoid bacillus produces no apparent growth on artichoke and does not change the colour of the medium, while the colon bacillus gives a thick yellowish growth and the artichoke at the same times assumes an intense green colour.

Technique.—Remove the leaves of the artichoke but leave the choke adhering to the heart: cut into small cubes with a silver-bladed knife, place the cubes with the choke uppermost into potato tubes containing a few drops of water in the lower bulb, plug with wool and sterilize at 115° C. Sow at the junction of the choke and heart.

Growth on caffeine media.—Roth has shown that the addition of 0·5 per cent. of caffeine to media prevents the growth of the colon bacillus but has no action on the growth of the typhoid bacillus. This characteristic is not absolutely constant since some strains of the typhoid bacillus will not grow in the presence of caffeine (Courmont).

Growth on malachite-green.—According to Loeffler the addition of a small amount (about 1 in 4000) of malachite-green to culture media favours the growth of the typhoid and paratyphoid bacilli while impeding the growth of

the colon bacillus. Kiralyfi has shown that this is not a constant phenomenon: according to this observer though malachite-green inhibits the growth of many micro-organisms—*e.g.* streptococci, staphylococci, vibrio cholerae,—it generally has no action on the colon bacillus.

Krystal-violet has the same action as malachite-green (Drigalski and Conradi): both typhoid and colon bacilli grow on media containing this dye while the growth of many other organisms is inhibited.

2. Variability of flagella.

Sunlight, antiseptics in dilute solution and temperatures unsuitable to growth have practically no influence on the number and shape of the flagella (Rémy and Sugg). When the typhoid bacillus has been grown in culture with the colon bacillus for some weeks the flagella are sometimes difficult to stain (Rémy). The rarity of variation in the morphology of the flagella is of importance in diagnosing the typhoid bacillus.

3. Viability and virulence.

Viability.—Exposure to a temperature of 60° C. kills the typhoid bacillus in 10–20 minutes but very low temperatures have no effect on its vitality; thus, Prudden found the organism still alive in a block of ice which had been kept for 3 months between –1° and –11° C. On the other hand, alternate freezing and thawing rapidly kills the bacillus.

In water, the typhoid bacillus retains its vitality for some time (Strauss and Dubarry, Chantemesse and Widal). In sterile water it has been found to be alive after 3 months. If the water contains saprophytic micro-organisms the typhoid bacillus disappears more quickly, but it can still be isolated after more than 1 month.

In soil, the bacillus can survive five months and a half (Grancher and Deschamps): drying kills it only after 1 or 2 months (Uffelmann). Levy and Kaiser isolated the organism from stools which after being in a cesspool for 5 months had been spread on the surface of the ground for 15 days in winter.

Light rapidly kills the typhoid bacillus. Cultures exposed to sunlight in the month of May were sterilized in 4–8 hours. Vincent has found that the blue, violet and ultra-violet rays are more efficient as bactericidal agents than the red and ultra-red rays. Cultures spread and dried on pieces of cloth, and then exposed to direct sunlight, were found to be sterilized in 9–26 hours (Vincent).

The typhoid bacillus is very sensitive to the action of antiseptics: the solutions of perchloride of mercury, carbolic acid, etc. in general use will kill the bacillus in a few minutes.

Virulence.—The great variations observed in the virulence of the typhoid bacillus and the methods by which the virulence can be raised have already been studied under the head of experimental inoculation.

4. The toxin of the typhoid bacillus.

The experiments conducted by Brieger and Fränkel with a view to isolating a toxin from the typhoid bacillus gave very little result. Attempts are now no longer made to extract a definite chemical substance from cultures. The crude toxin found in sterilized cultures has been studied by Sanarelli, Chantemesse and others. Other observers (Macfadyen and Rowland, Bearedka and others) have prepared extracts containing an endotoxin from the bodies of the organisms.

1. Toxin of Sanarelli. (*a*) **Method of preparation.**—Sanarelli uses a virus the virulence of which has been raised by passing it through the peritoneal cavities of guinea-pigs (p. 368). The bacillus is sown in 2 per cent. glycerin-broth and after incubating at 37° C. for a month is sterilized by heat and allowed to remain at room temperature for 8 months. The flask containing the culture is then sealed in the flame and heated to 60° C. for a few days. During this long period of maceration the intra-cellular toxin diffuses into the culture fluid and this, carefully decanted, constitutes the toxin of Sanarelli.

Gauthier and Balthazard justifiably point out that Sanarelli's toxin is a complex mixture containing substances foreign to the typhoid bacillus, and derived partly from the albuminoid substances present in the medium, partly from the dead bodies of the bacilli, etc. which have slowly undergone disintegration. It is nevertheless true that animals inoculated with the different toxins prepared by Sanarelli, Chantemesse, and Balthazard exhibit identical symptoms.

(*β*) **Action on laboratory animals. On rabbits.**—The toxin given sub-cutaneously in doses of 10 c.c. per kg. of body weight kills rabbits weighing 700–1000 grams.

Soon after inoculation the animal is seen to breathe more rapidly and to become unsteady on its legs; a general paralysis gradually comes on and about 10 hours after inoculation convulsions occur ending in death. The temperature is at first a little raised (about 1° C.) but soon falls below normal and death takes place while the temperature is still sub-normal. The effects of the toxin vary in different animals: death is not infrequently delayed for some days and in that case is preceded by a period of cachexia of which the characteristic signs are wasting, diarrhoea, etc. *Post mortem*, the abdominal organs are found to be anæmic, and it is noticeable that there is neither congestion of the intestinal mucous membrane nor swelling of the Peyer's patches.

On mice.—1 c.c. of toxin inoculated sub-cutaneously or 0.2 c.c. intra-peritoneally is generally fatal, death taking place in a few hours. *Post mortem* the spleen is enlarged and there is a small amount of a sterile effusion in the peritoneal cavity.

On guinea-pigs.—Guinea-pig inoculation is an excellent means of testing typhoid toxin—sub-cutaneously the minimal fatal dose is 1.5 c.c. per 100 grams of body weight. Intra-peritoneally the results are less constant. Sub-cutaneous inoculation of 4 or 5 c.c. of toxin per 100 grams of body weight leads to death in 15–20 hours.

From the moment of inoculation the temperature falls and continues to do so until death. About an hour after inoculation there is marked abdominal distension accompanied by extreme tenderness, the animal does not move, but sits huddled up and cries if touched: after 4 or 5 hours it is extremely dejected, its eyes are half-closed and it is seen to be in an almost uninterrupted state of tremor; a profuse sometimes hæmorrhagic diarrhoea is often present, and finally paralysis appears, the meteorism vanishes and death takes place. *Post mortem* a variable quantity of exudate rich in leucocytes and sometimes turbid is found in the peritoneal cavity; the spleen is enlarged, congested and friable: the walls of the small intestine are distended and completely infiltrated with blood, the mucous membrane is red and the lymphatic patches are infiltrated and congested; the stomach and suprarenal capsules are intensely congested and ecchymosed. The intestine is full of liquid matter and contains a very virulent colon bacillus in pure culture.

On monkeys.—Monkeys are very susceptible to the toxin of the typhoid bacillus: the course of the disease and the lesions are the same as in the guinea-pig.

2. Toxin of Chantemesse. (*a*) **Method of preparation.**—Chantemesse at first recommended growing an organism of increased virulence in a maceration of spleen and bone marrow. He now, however, prefers to use a bacillus

whose virulence has been increased by growing it in collodion sacs in the peritoneal cavities of guinea-pigs, and to sow it in a solution of spleen peptone.¹

Incubate at 37° C. : a week later the toxicity will be at a maximum. Then either filter through porcelain, or preferably, heat to 55° C., centrifuge, and decant the supernatant liquid which contains the toxin.

(*β*) **Properties.**—This toxin is more powerful than Sanarelli's and kills a guinea-pig weighing 500 grams in 12–24 hours when inoculated in quantities of 6 c.c. intra-peritoneally (that is about 1 c.c. per 80 grams).

It is a very unstable product, being quickly affected by air and light, and its toxic properties are diminished if it be heated to 100° C. for a few minutes. It must be stored in accurately filled tubes and kept in the dark.

3. Toxin of Bandi.—The bacillus after the virulence has been raised by passing it through the peritoneal cavities of a long series of guinea-pigs is sown in Loeffler's broth, incubated for 48 hours and filtered. The filtrate inoculated sub-cutaneously in quantities of 4 c.c. is sufficient to kill a guinea-pig weighing 400–500 grams.

4. Toxin of Lépine and Lyonnet.—A virulent culture in broth, 4–8 days old, is sterilized at 55°–60° C. for an hour. The product is toxic for dogs and horses.

5. Toxin of Rodet, Lagriffoul and Wahly.—Cultures of the typhoid bacillus are incubated on well aerated media for 3 days and filtered. The filtrate kills guinea-pigs when inoculated intra-peritoneally in doses of 4 c.c. per 100 grams of body weight, and rabbits when inoculated intra-venously in doses of 1 c.c. per 100 grams.

M. and Mme. Werner after growing the organism for 3 days in an aerated medium sealed the flasks and left them for 2 days at 25° C. The filtered liquid killed guinea-pigs when inoculated intra-peritoneally in quantities of $\frac{1}{3}$ c.c. per 100 grams of body weight, and rabbits when inoculated intra-venously in quantities of 0.1 c.c. per 100 grams.

6. Toxin of Moreschi.—Moreschi grew the bacillus for 5 days in a special broth and then filtered the culture through porcelain. The filtrate when injected intra-peritoneally in doses of 0.2 c.c. killed a guinea-pig weighing 250 grams.

The special broth is prepared as follows :—

Mince 1000 grams of horse meat and 1000 grams of ox's spleen, macerate for 24 hours at room temperature in a litre of water, boil, filter, make up to 1 litre and add

| | | | | | | | | | |
|------------------|---|---|---|---|---|---|---|----|--------|
| Witte's peptone, | - | - | - | - | - | - | - | 20 | grams. |
| Plasmon, | - | - | - | - | - | - | - | 10 | „ |
| Sodium chloride, | - | - | - | - | - | - | - | 5 | „ |
| Ox blood, | - | - | - | - | - | - | - | 80 | „ |

Heat the mixture to 120° C. in the autoclave for 20 minutes, neutralize, and add 0.15 per cent. of caustic soda. Heat again to 120° C. Filter, tube and sterilize.

After being sub-cultured several times on this medium the bacillus grows as a very thick film on the surface while the broth remains clear. When the growth assumes these characteristics the culture has reached its maximum of toxicity.

7. Toxin of Conradi.—The bacillus is grown on agar for 20 hours, scraped off, mixed with a little normal saline solution and kept in the incubator at 37° C. for 24 hours. The emulsion is then diluted with more normal saline solution and filtered through a Berkefeld bougie ; the filtrate is evaporated

¹ The medium used by Chantemesse is prepared by macerating spleen and bone marrow in cold distilled water, filtering through porcelain and adding a little defibrinated human blood.

The solution of spleen peptone is obtained by digesting a pig's spleen and stomach in acidulated water (*vide* Martin's peptone) making slightly alkaline and sterilizing. Cultures are grown in a shallow layer of the medium contained in large wide-bottomed flasks.

in vacuo to $\frac{1}{10}$ th or $\frac{1}{50}$ th its original volume. The product when injected intra-peritoneally in doses of 0.2 c.c. kills a guinea-pig weighing 300 grams.

8. Toxin of Macfadyen and Rowland.—The growth on agar is scraped off and cooled to -90° C. by means of liquid air, then triturated at a very low temperature in a special apparatus. The product is diluted in normal saline solution and centrifuged. The supernatant liquid is very toxic and is fatal to guinea-pigs when inoculated intra-peritoneally in doses of 0.1 c.c.

Bassenge and Mayer obtained a similar but less toxic product by freezing the bacilli with liquid air and grinding them up in a hand mortar.

9. Toxin of Balthazard. (a) **Mode of preparation.**—The principle is the same as that underlying Macfadyen and Rowland's method.

A bacillus whose virulence has been increased by growing it in collodion sacs in the peritoneal cavities of guinea-pigs, is sown on large surfaces of agar contained in flat flasks (the agar is prepared with a 3 per cent. solution of Defresne's peptone and contains no meat). After incubating for 24–48 hours the growth is scraped off, mixed with a little normal saline solution and rapidly centrifuged. The deposit is again shaken up with normal saline solution and centrifuged a second time. In this manner all foreign matter is removed.

The bacilli are then mixed with a 2 per cent. solution of urea or 1 per cent. solution of ammonium chloride (the effect of these solutions is to swell and break the cells and so facilitate the diffusion of the intra-cellular products). The emulsion thus obtained is distributed into tubes which are completely filled and sealed in the flame.

To facilitate the diffusion of the intra-cellular products, the tubes are now alternately frozen and thawed. They are kept at 58° C. for 8 days and daily submitted to a temperature of -21° C. for a couple of hours in a refrigerating machine (the evaporation of methyl chloride being adopted as the cooling agent). At the end of 8 days the tubes are centrifuged for 24 hours. The bacilli collect at the lower end of the centrifuge tube and the supernatant liquid carefully decanted constitutes the toxin.

(b) **Properties.**—Balthazard's method though lengthy and expensive yields a very powerful toxin, containing products of the typhoid bacillus unmixed with foreign substances. Inoculated sub-cutaneously in doses of 3 c.c. it kills rabbits weighing 2 kg. and in doses of 2 c.c. guinea-pigs weighing 200 grams. It is however less toxic than Conradi's toxin, which has the further advantage of being more easily prepared.

The action of Balthazard's toxin on animals generally is similar to that of the toxins prepared by Sanarelli and by Chantemesse; but its action on rabbits appears to be more constant.

10. Endotoxin of Besredka.—Dried typhoid bacilli killed by heating for 1 hour at 60° C. are ground up with sodium chloride until an impalpable powder is obtained. This powder is diluted with water added drop by drop and the mixture left over-night. Next morning it is warmed in a water bath to 60° – 62° C. for 2 hours, and then allowed to settle. The supernatant liquid contains the endotoxin. The average lethal dose for white mice is 0.05 c.c. intra-peritoneally. The endotoxin is destroyed only by temperatures above 127° C.

11. Typho-lysin.—As early as the second day filtered cultures of the typhoid bacillus show distinct powers of hæmolysis. This property increases with the age of the culture up to the fifteenth day when it is at its maximum (E. and P. Levy). Macfadyen and Rowland demonstrated the presence of typho-lysin in an eight-day culture grown on macerated spleen. This hæmolysis of the typhoid bacillus is not destroyed at 55° C.

The red cells of the dog are very sensitive to typho-lysin, and dogs which have been repeatedly treated with heated cultures yield an antitypholytic serum.

5. Vaccination.

A. Immunization of the lower animals.

(i) Beumer and Peipper immunized white mice by inoculating them daily for several days with increasing doses of living cultures. Guinea-pigs, rabbits, and especially goats and dogs may be vaccinated in a similar manner (Pfeiffer, Loeffler and Abel). Vincent immunized dogs and rabbits by inoculating them first with cultures heated to 60° C., then with living cultures 16 hours old, and finally with more toxic cultures 15–20 days old. The serum of animals so treated has both immunizing and agglutinating properties: immunized animals are however not immune to an intra-cerebral inoculation of typhoid toxin.

(ii) Brieger, Wassermann and Kitasato used for their immunizing experiments organisms attenuated by being grown in thymus broth (p. 34). Inoculations of a culture of a virulent bacillus grown in thymus broth and heated to 60° C. produced immunity in guinea-pigs and mice.

(iii) Sanarelli, Chantemesse and Widal, Beumer and Peipper immunized animals by inoculating them with cultures sterilized by heat.

(a) Sanarelli incubated a culture of a bacillus of increased virulence in peptone broth for a week at 37° C. and sterilized the growth at 120° C. The sterilized product possessed vaccinating properties.

Generally, it may be said that to immunize guinea-pigs weighing 400 grams it is only necessary to inoculate them several times over a period of 5 days with 16–18 c.c. of sterilized cultures. The animals are immune 4 days after the last inoculation and will then resist the inoculation of a virus of exalted virulence. During the process of immunization the animals lose a certain amount of weight but quickly recover.

It is very difficult to immunize rabbits for they are far more susceptible than guinea-pigs and death often takes place during the immunizing process; but animals which survive the treatment are immune in a high degree.

(b) Chantemesse and Widal used broth cultures incubated at 37° C. for 15 days and then sterilized at 100° C.

Twenty c.c. are necessary to immunize a guinea-pig: the toxin should be inoculated in four doses allowing a few days to elapse between each inoculation. Immunization takes a fortnight; after the lapse of another 8 days the test inoculation may be performed (2 c.c. of a virulent culture into the peritoneum). Not infrequently the animals die either during the immunizing process or as the result of the test inoculation.

Rabbits may be immunized in a similar manner but in these animals the process is even more difficult.

(c) Beumer and Pfeiffer immunized sheep in a like manner with cultures heated to 60° C. for an hour.

For immunizing horses Funck prefers to use cultures sterilized with carbolic acid.

(iv) Chantemesse immunized horses by injecting them with gradually increasing doses of his toxin (*vide supra*).

The immunization of horses is very difficult; the inoculations whether made sub-cutaneously or intra-venously have frequently to be interrupted on account of the violence of the reaction, and it takes several years to produce a lasting immunity.

B. Human vaccination.

For many years the problem of the vaccination of the human subject against enteric fever has been under investigation. In 1896, Pfeiffer and Kolle showed that as a result of inoculating man with a small quantity of

a sterilized culture¹ the serum acquired bactericidal and agglutinating properties for the typhoid bacillus.

Since then numerous methods of antityphoid inoculation have been devised, some based on the inoculation of "whole" cultures (Pfeiffer and Kolle, Wright, etc.) others on the use of extracts made from the bodies of the bacilli. Finally, Besredka has conceived a method of vaccinating with bacilli sensitized with antityphoid serum.

1. Methods based on the use of "whole" cultures.

(a) **The Wright-Leishman method.**—Wright's original method has been modified in view of the experiments of Leishman and Harrison. Wright now uses a bacillus of low virulence which he grows at 37° C. for 24–48 hours in a shallow layer of peptone broth to facilitate aëration, sterilizes by heating to 53° C. for an hour (not at 60° C. as in his original method), and then adds 0.25 per cent. of lysol to ensure its sterility.

Two inoculations into the outer surface of the arm or over the pectoral muscle are given: the first of 500 million bacilli (0.5 c.c. of vaccine), the second 10 days later of a 1000 million bacilli (1 c.c. of vaccine).

The doses prescribed by Wright and Leishman should be scrupulously observed: too small a dose will fail to produce immunity and too large a dose will be followed by a sharp reaction and may fail to vaccinate (Wright, Paladino-Blandini). It is therefore necessary to enumerate the bacillary content of the vaccine in order to standardize it.

Standardisation of the vaccine.—Mix a measured volume of vaccine with an equal volume of a known dilution of blood, make a film, stain and count the number of bacilli and red cells in several fields of the microscope. The number of red cells per cubic centimetre being known, the number of bacilli is easily calculated.

(β) **Pfeiffer and Kolle's method.**—Cultures on agar 24 hours old are scraped with a platinum needle and the growth mixed with saline solution (45 c.c. for ten tubes). The emulsion is filtered through gauze, the filtrate is heated to 60° C. for 2 hours, then distributed in tubes and a little carbolic acid added. The quantity to be used for the first dose is 0.5 c.c. (corresponding to 1 loopful or 2 milligrams of fresh culture or $\frac{1}{10}$ th of an agar culture): 8 or 12 days later a second dose of 1 c.c. is given. A third dose may with advantage be given; if this be purposed it is well in order to obviate any violent reaction to use smaller doses viz.: 0.3 c.c., 0.8 c.c., and 1 c.c.

(γ) **Bassenge and Rimpau's method.**—These authors adopt a technique similar to that of Pfeiffer and Kolle, but to avoid too violent a reaction they give four inoculations of very small quantities with an interval of 10 days between each: for the first inoculation a dose equal to $\frac{1}{30}$ th of a loopful is given and then successive doses of $\frac{1}{15}$ th, $\frac{1}{8}$ th, and $\frac{1}{2}$ th of a loopful.

(δ) **Friedberger and Moreschi's method.**—A minimal quantity ($\frac{1}{1000}$ th or $\frac{1}{10000}$ th of a loopful) of an eighteen-hour culture on agar dried and heated to 120° C. for 2 hours is inoculated intra-venously. A single inoculation is sufficient but the intra-venous does not seem as harmless as the sub-cutaneous method and is followed by a violent reaction.

2. Methods based upon the use of bacillary extracts.

The active principle of the typhoid bacillus can be extracted by the different methods which have been studied under the head of typhoid toxin: maceration, trituration, freezing, etc. Methods of antityphoid vaccination based

¹ At first it was the custom to use very virulent bacilli. Wassermann has shown that there is no direct and constant relation between toxigenic and immunizing power: he suggests the use of a polyvalent vaccine prepared with a mixture of many strains of typhoid bacilli; such a vaccine is said however to have no advantage over a monovalent vaccine (Bassenge and Mayer).

on the use of bacillary extracts are complicated and do not seem to offer any particular advantages over those just considered.

(*a*) **Wassermann's method.**—An emulsion of cultures on agar is made in distilled water, heated to 60° C. for 24 hours, macerated for 5 days at 37° C., filtered through porcelain and dried *in vacuo* at 35° C. A single inoculation is given consisting of 0.0017 gram of the powder.

(*β*) **Neisser and Shiga's method.**—An emulsion of cultures on agar is made, sterilized at 60° C., macerated at 37° C. for 3 days, and then filtered. The filtrate without further preparation is used as a vaccine.

(*γ*) **Bassenge and Mayer's method.**—A filtrate of living cultures is used. Make an emulsion in distilled water of the growth of a very virulent bacillus on agar and, after shaking continuously for 3 days, filter. A single inoculation is given equal to the filtrate obtained from one tube of culture.

Effects of vaccination.

The results obtained in man with Wright's and with Pfeiffer and Kolle's vaccines will be chiefly quoted, as these are the best known methods and appear to give the most satisfactory results.

Two or three hours after inoculation tenderness develops about the site of inoculation, reaches its maximum in about 12 hours, and vanishes as a rule about 40 hours after inoculation.

At the same time there is some rise of temperature accompanied by stiffness of the back and limbs, headache, loss of appetite and nausea lasting twenty-four hours or so.

About the end of the first week the serum has acquired bactericidal, agglutinating, bacteriolytic and immunizing properties, and the opsonic index is raised. These newly-acquired properties rapidly increase and reach their maximum on the third day after the second inoculation.

The bactericidal and agglutinating properties persist for a long time, having been demonstrated 18 months later by Bassenge and as long as 4 years afterwards by Harrison and others. In a person previously immunized and whose serum no longer exhibits any appreciable bactericidal properties, the inoculation of a very small dose of vaccine will re-create these properties in a very high degree (Wassermann): it would therefore appear desirable to repeat the vaccinating inoculations at intervals in order to maintain and re-enforce the immunity.

Wright has drawn attention to a fact which is very important from the point of view of prophylaxis. During the first few days—less than a week—after inoculation there is a negative phase during which the resistance-capacity of the patient to the typhoid bacillus is lowered. During this period therefore vaccinated persons should not be exposed to infection, and it follows that antityphoid vaccination as now practised is not permissible in times of epidemic nor in endemic centres of the disease.

Antityphoid vaccination in the human subject has been largely practised in the English and German armies. The results are quite conclusive in favour of vaccination. Among the vaccinated the proportion of cases is markedly lower than among the unvaccinated; moreover, the cases of enteric fever which have been observed among the vaccinated have, as a rule, been less severe than among the unvaccinated, and the mortality rate is lower by one-half. The effects of antityphoid vaccination last for several years.

3. Besredka's method.

The immunity conferred by the use of antityphoid serum being very transitory, and the progress of vaccination with attenuated cultures very

slow and irregular, it has been suggested by several observers (Leclainche, Calmette, Salimbeni) that mixtures of specific serum and micro-organisms might prove more effective. The results so far obtained have been only moderately encouraging, probably because there has been too much serum in the mixtures used for inoculation.

Bearing in mind the property possessed by organisms of fixing the immune body present in their specific serums, Besredka sensitizes bacilli with antityphoid serum and uses the sensitized organisms for vaccinating purposes. An emulsion of bacilli from a forty-eight-hour culture on agar is made in normal saline solution, mixed with antityphoid serum and left at 37° C. for 24 hours. The agglutinated bacilli are then centrifuged and washed several times with normal saline solution until all traces of serum have disappeared; the emulsion is then heated in a water bath at 58° C. for half an hour.

Guinea-pigs can be rendered highly immune in about 20 hours by inoculating them sub-cutaneously with the vaccine. The immunity lasts for several months (Besredka, Paladino-Blandini) and the serum of the animals is bactericidal and prophylactic.

In man, inoculation with Besredka's vaccine produces only a very slight tenderness locally, and there is ground for hoping that this method, which confers immunity within 24 hours, will in future play an important part in the prophylaxis of enteric fever.

6. Serum therapy.

Brieger, and Wassermann and Kitasato, whose experiments have been confirmed by Sanarelli, Chantemesse and Widal and others, have shown that laboratory animals can be immunized against experimental infection by inoculating them with the serum of a vaccinated animal, and that such a serum possesses curative as well as prophylactic properties.

If a fatal dose of a culture of the typhoid bacillus be mixed with 0.5 c.c. of the serum and inoculated into the peritoneal cavity or beneath the skin of a guinea-pig the animal remains unaffected.

Guinea-pigs can be immunized in a few hours by inoculating them with 2 c.c. of the serum of a vaccinated animal. Subsequent inoculation of a dose of a virus of exalted virulence sufficient to kill a control animal is without effect on the treated animal.

Similarly, animals inoculated with an ordinarily fatal dose of culture recover if, within 3 hours of the inoculation, 1-2 c.c. of antityphoid serum be administered to them.

Chantemesse and Widal have shown that the serums of patients who have recovered from an attack of enteric fever exhibit both prophylactic and curative properties. These properties are not very well marked, and to immunize a guinea-pig about 10 c.c. of serum are necessary. Attempts to use the serum in the treatment of human enteric fever have not given conclusive results.

Artificial animal serums have been used by a great many observers in the treatment of enteric fever, but with little result (Beumer and Peipper, Shaw, Tavel, Aronson, and others).

Chantemesse and Besredka however have prepared serums which undoubtedly possess therapeutic powers.

A. Chantemesse's serum. 1. **Preparation.**—Chantemesse immunizes horses by repeated sub-cutaneous inoculations of his soluble toxin (p. 377) and intravenous inoculations of virulent typhoid bacilli. The process of immunization is very lengthy; small doses should be used to begin with, and the animals must be carefully handled.

2. **Properties.**—Chantemesse's antityphoid serum may be repeatedly

heated to 54°–56° C. without losing any of its properties. It shows marked agglutinating power (1 in 100,000, p. 413). *In vitro* it has no bactericidal action, but *in vivo* it stimulates the leucocytes to take up and dissolve the bacilli. It protects guinea-pigs and rabbits against the inoculation of lethal doses of an exalted virus. It is markedly antitoxic (Balthazard and Chantemesse), and neutralizes toxin *in vitro*. If given as a prophylactic, 2–24 hours before the inoculation of the toxin, it will protect rabbits against the effects of four times the lethal dose of toxin. When the serum is inoculated at the same time as the toxin but at an independent site its action is less pronounced, and animals which have received more than twice the lethal dose succumb (Balthazard). When injected after the toxin the serum has still less prophylactic and curative powers, and its efficacy varies inversely as the time which has elapsed between the inoculation of the toxin and the inoculation of the serum. The prophylactic properties of the serum are short-lived and the immunity conferred lasts no longer than 10 or 12 days.

3. Therapeutic application.—Chantemesse's serum which in the laboratory shows only feeble curative power has a marked influence on the phenomena of opsonization, and it is probably to this that its undoubted therapeutic properties in the treatment of enteric fever are due: according to statistics published by Chantemesse the mortality in cases treated with the serum is only 4 per cent. It is all important that the serum should be used in the early stages of the disease. Originally Chantemesse inoculated repeated doses of 5–15 c.c. sub-cutaneously, but the serum as now prepared is more active and a single inoculation of a few drops is sufficient.

B. Besredka's serum.—An anti-endotoxic serum has been prepared by Besredka, by inoculating killed cultures followed by living cultures of the bacillus into the veins of animals.

The serum neutralizes ten to twenty fatal doses of Besredka's endotoxin and acts as a prophylactic to the inoculation of the endotoxin.

Montefusco, who has used Besredka's serum in the treatment of enteric fever at Naples, has obtained very satisfactory results, and thinks it will be of great value in the treatment of the disease.

7. Agglutination. Serum-diagnosis of enteric fever.

Durham and Gruber were the first to show that [an antiserum] agglutinates [its homologous organism]. This agglutinating property, which is a reaction of infection (p. 225), is also manifested in the blood of persons suffering from or who have recovered from an attack of enteric fever. Agglutination can also be obtained with the blister fluid, milk, naturally shed tears, and occasionally even with pus, urine, bile, etc. from these persons.

[A. S. Grünbaum first and] Widal [afterwards] utilized the agglutinating properties of the blood of enteric fever patients as a rapid and conclusive method of diagnosis—the serum diagnosis of enteric fever.

The power of agglutinating the typhoid bacillus is developed in the blood of the patient as a rule in the early days of the illness, and while it may not infrequently be delayed, it is only very exceptionally that it is absent throughout the whole course of the disease; (Widal and Sicard failed to get agglutination once only in 163 cases: Besson twice in 98 cases). The power of agglutination may disappear during the early weeks of convalescence, and is generally absent 6–8 months after recovery; but occasionally it has been present as long as 3 and even 7 years after the attack.

A positive result obtained under the conditions to be immediately described

may be taken as a certain indication of enteric fever.¹ On the other hand a negative result establishes merely a probability that the disease is not enteric fever. A negative result in the early days of a suspected attack of the disease is of less value than one obtained later, for if the disease be enteric fever failure to react is then improbable. But in any case if the result be negative opportunity should always be taken to test the blood again later.

The reaction may be performed in several ways which are described as *slow* or *rapid* according to the time required: but whatever the method adopted the following rules must be observed.

General rules.—1. For the slow methods the blood must be taken under aseptic precautions from a vein at the bend of the elbow (p. 193), and may be conveniently collected in small sterile glass tubes. For the rapid methods sufficient blood can be collected in capillary tubes by pricking the finger (p. 192).

2. When the blood has to be sent some distance to a laboratory the tube in which it has been collected should be plugged with a plug of wool passed through the flame. Serum kept in the liquid condition retains its power of agglutination for a very long time. Since, however, drying has no effect on the agglutinating power of the blood, a few drops of the latter may be collected on a piece of paper or on a glass slide and allowed to dry before being sent to the laboratory, and in some cases this may be the more convenient course to adopt. For purposes of the agglutination reaction the dried blood is dissolved in a drop or two of sterile water.

In the author's experience good results have always been obtained when the blood was dried on glass but when dried on paper it seemed to lose some of its agglutinating power. Dried blood is only available for use by the rapid method.

3. The culture should always be examined microscopically to test its purity immediately before being used for the reaction. The mistakes which might arise from the use of an impure culture can be readily appreciated.

4. The serum must be added to the culture and not *vice versa* (p. 226).

A. Slow method.—The blood (collected from a vein at the bend of the elbow to ensure that a sufficient quantity is obtained) must be absolutely pure and uncontaminated, and after collection should be set aside in a sterile tube until the clot has separated; the serum is then drawn up into a Pasteur pipette.

1. To a tube containing 6–10 c.c. of sterile broth, add ten drops of the serum and sow with a trace of a culture of the typhoid bacillus. A control consisting of a tube of broth containing no serum but sown with a trace of a typhoid culture must, of course, be put up. Incubate the tubes at 37° C. Growth in the tube to which the serum has been added will be somewhat delayed, but small clumps appear after 8 hours or so, and after about 18 hours' incubation the appearance is characteristic: the bacilli are collected together at the bottom of the tube in little whitish flocculi, which cannot be

¹ In suspected cases, the possibility of the patient having had previously an attack of enteric fever should always be borne in mind, because if so the blood might still retain some agglutinating power. A few rare cases are on record in which it was found that the blood of persons suffering from diseases other than enteric fever has agglutinated the typhoid bacillus in dilutions of 1 in 100 and 1 in 250. Thus in an undoubted case of pneumonia in a young man in which there was no reason to suspect a previous attack of enteric fever Besson found that the blood of the patient agglutinated the typhoid bacillus. The serum reaction in the absence of enteric infection has also been observed in a case of tuberculous meningitis (E. Mackey) and in a case of abscess of the liver (Megele). In pathological conditions in which the bile enters the blood stream, as for instance in jaundice or occlusion of the bile-duct, the blood may agglutinate the typhoid bacillus (Grünbaum, Zupnik, Kohler and others).

broken up by shaking the tube, while the broth remains perfectly clear. In the control tube, on the other hand, the broth is cloudy and shows the scintillating ripples characteristic of a growth of the typhoid bacillus.

The reaction is not always so distinct as this. Sometimes the broth instead of remaining clear shows an irregular turbidity, from which however the characteristic watered-silk appearance is absent; this turbidity is due to the precipitation of a very fine powder each grain of which when examined under the microscope is seen to be an agglomeration of bacilli. At other times the reaction may be quite characteristic at first but after incubating for 18 or 24 hours the broth is turbid above the precipitate. Naked eye appearances ought always to be supplemented by a microscopical examination by means of which the small masses of bacilli may be recognized if present and their structure defined.

2. Add the serum to a twenty-four-hour broth culture of the typhoid bacillus and incubate at 37° C. If the agglutinating power of the serum is well marked characteristic changes will take place within a few hours; the culture is at first granular, but becomes gradually clear as the bacilli fall to the bottom. When the serum is less powerfully agglutinating, clumps are formed but the broth never becomes quite clear. Naked eye appearances must, as in the previous case, always be controlled by microscopical examination.

B. Rapid method. Recommended.—This method is quicker and more sensitive than the foregoing and has the additional advantage of requiring only a few drops of blood, an amount which can be easily obtained by pricking the finger. It is therefore the method to be used in the majority of cases.

A broth or peptone culture of the typhoid bacillus is required for the reaction, and the greatest care should be exercised in the choice of a culture. In the first place it is of course essential that it be pure: secondly the growth must not be more than 24 hours old, because in old cultures clumps often form spontaneously and these will falsify the results. Spontaneously formed clumps may indeed be present even in twenty-four-hour cultures, so it is always necessary to determine by microscopical examination immediately before use that the chosen culture is satisfactory in this respect. A quantity of culture sufficient for the investigation should be drawn up into a Pasteur pipette and a little placed on a slide and examined under the microscope, the remainder, if the sample is satisfactory, being used for the serum reaction. To obviate the spontaneous formation of clumps in cultures it is better to grow the organism in a 1 or 2 per cent. solution of peptone containing no meat rather than in broth.

The method is as follows.

1. Reaction with the serum.—[(a) *Technique recommended.*—1. Take a sterile Pasteur pipette, plugged with wool and fitted with an india-rubber teat as shown in fig. 162, p. 241. Make a mark on the stem of the pipette.

[2. Take up 9 volumes of the peptone water culture run them up into the bulb and then take up 1 volume of the serum. Mix the culture and serum thoroughly by repeatedly expelling on to a slide and aspirating. (Dilution 1.)

[3. Take up 4 volumes of dilution 1 and 1 volume of serum. Mix. (Dilution 2.—1 in 50.)

[4. Take up equal volumes of dilution 2 and culture. Mix. (Dilution 3.—1 in 100.)

[And so on, preparing the dilutions required.

[Place a drop of each dilution on a clean cover-glass and invert the latter over the cavity in a hollow-ground slide. Lute the edge with vaseline. Place the preparations in the incubator at 37° C. Examine with a high power dry lens at the end of half an hour and again at the end of an hour. If the serum

be a typhoid-agglutinating serum the bacilli will be found agglutinated together in more or less large masses.]

(β) *Another method.*—Into a small conical glass vessel introduce 10–100 drops of the culture and 1 drop of the serum. Place a drop of the mixture on a slide and cover with a cover-glass. Examine with a high power dry lens. If the serum has the power of agglutinating the typhoid bacillus, masses of agglutinated bacilli will be seen and among them a greater or smaller number of non-agglutinated bacilli. The reaction is still more distinct if the preparation be examined after 15 or 20 minutes, for compact islets of agglutinated bacilli will then be visible under the microscope. When the agglutinating property of the serum is small the reaction may only appear after the lapse of 40 minutes or an hour. The appearance is quite characteristic and renders mistakes impossible. Agglutination is assisted by a slight drying at the edge of the drop between the slide and the cover-glass.

Whole blood.—The whole blood may be used for the reaction, but before examining the preparation under the microscope time must be given to allow most of the red cells to settle, since the presence of a large number of cells detracts from the sharpness of the reaction. The method is therefore no quicker than the serum method.

Method of staining.—The preparation may be stained—so as to render the masses more distinct—and preserved for future use: for this purpose the following technique, described by Guillemin, gives good results.

Mix 1 drop of the whole blood with 9 drops of sterile broth, and add 1 drop of this to 2–5 drops of a culture of the typhoid bacillus. Spread a large drop of the mixture on a slide: place in a moist chamber for an hour or two: dry slowly, fix in alcohol-ether, treat with 10 per cent. acetic acid to dissolve the red cells, wash, stain with dilute carbol-fuchsin, wash and dry.



FIG. 220.—Agglutination of the typhoid bacillus by a specific serum. Jenner's stain. (Oc. 2, obj. D. Zeiss.)

2. Reaction with dried blood.—The blood collected and dried as already described is dissolved immediately before use in a drop or two of water. The solution is added to 10–50 drops of a broth culture of the typhoid bacillus contained in a conical glass vessel. It is left for a moment to allow the red cells to settle and then examined as before.

3. Reaction with dead bacilli.—The phenomenon of agglutination is not dependent upon any vital reaction of the bacilli, since it can be demonstrated with dead organisms. This fact may in certain circumstances be of practical value, because a recent culture of the typhoid bacillus is not always immediately available with which to perform the reaction, and to obtain one may involve a delay of 12 hours or so. In such a case a dead culture may be used, since experience has shown that such a culture retains its sensitiveness towards an agglutinating serum for several weeks. The following technique may be adopted in the preparation of a dead culture for this purpose (Widal and Sicard).

A sixteen- or twenty-four-hour culture of the typhoid bacillus is examined microscopically to test its purity. Formalin in the proportion of 2 drops to 15 c.c. of culture is added to kill the bacilli, which become as it were embalmed. Care must be taken to cover the cotton-wool plug of the vessel containing the culture with an india-

rubber cap. Cultures killed in this way may be stored exactly as chemical reagents are stored in the laboratory. Immediately before use the tube is lightly shaken so that the bacilli shall be uniformly distributed through the medium. To a few drops of this dead culture a few drops of serum are added in the same manner as has been described above.

There are now a number of preparations of dead bacilli on the market such as Ficker's "*Typhus diagnosticum*," Stassano's emulsion, etc. These preparations allow the practitioner to perform a serum diagnosis rapidly and easily. The "*Typhus diagnosticum*" of Ficker in particular has given good results in the hands of many bacteriologists—though its reliability is questioned by de Rossi.

De Rossi advises the use of broth cultures which have been heated to 58°–60° C. for an hour. The resulting emulsion agglutinates more readily than unheated cultures and preserves its property for at least 3 months.

Tribondeau uses broth cultures killed by the addition of formalin (1–150) and stored in sealed ampoules. Under these conditions the bacilli retain their capacity for agglutination for 4 years and more.

Measurement of the agglutinating titre.—The serums of different patients vary in their agglutinating powers; sometimes this power is very feeble while in other cases it is so well marked that clumps are formed when the serum is diluted as much as 1–5000 and 1–15,000 (Jurgens).

In investigating the agglutinating property of a given serum the examination should be begun with a dilution of 1–10. Agglutination in a lower dilution than this is in no way characteristic, and indeed, since normal human serum occasionally agglutinates when diluted 1 in 10 or even 1 in 20 (*vide* colon bacillus), a reliable diagnosis can according to Rémy only be given when agglutination is found with a dilution of 1 in 50. [Moreover with some serums there appears to be an agglutination-inhibiting action when examined in low dilutions.] The degree to which the agglutinating power is developed should therefore be measured more exactly by investigating dilutions of 1 in 20, 1 in 30 [and so on to at least a dilution of 1–100].

In practice when but a small quantity of blood is available two tests suffice, one made with a dilution of 1 in 10 the other with a dilution of 1 in 50. [By the method described above (B. 1. a) if a dilution of 1 in 10 can be obtained a dilution of 1 in 100 and 1 in 500 can also be made. In our experience a dilution of 1 in 100 is the smallest dilution upon which a reliable opinion can be based in suspected cases of enteric fever.]

Widal and Sicard draw the following distinctions.

| |
|--|
| Agglutinating power very feeble if exhibited only in dilutions below 1 in 100. |
| Agglutinating power feeble if exhibited only in dilutions between 1 in 100 and 1 in 200. |
| Agglutinating power average if exhibited in dilutions 1 in 200 and 1 in 500 |
| " " marked " " 1 in 500 and 1 in 2000. |
| " " very marked " " above 1 in 2000. |

Note.—In these measurements it is important that the drops of culture and of the serum be equal in size. A sufficient degree of accuracy is attained by the following method: take a piece of glass tubing about 20 cm. long and plug it at both ends with wool. Draw it out in the flame as though making a Pasteur pipette. Sterilize the tube without cutting it into two and then, when about to use it, file it in the middle of the capillary portion. In this way, two pipettes are obtained, which for all practical purposes will give drops of equal size: one will serve for the culture, the other for the serum.

From the point of view of prognosis, it appears that the degree to which the agglutinating power is developed [has no consistent relation to, and therefore] furnishes no reliable information as to the severity of the disease.

[Co-agglutinins in the serums of enteric patients.]

[In addition to the specific, homologous or primary agglutinins for the typhoid bacillus, the serum of enteric fever patients often contains group or heterologous or secondary agglutinins for bacilli of the paratyphoid and salmonella groups.

[In a consecutive series of 86 serums Boycott found that 59 per cent. contained secondary agglutinins and of this series 55 per cent. reacted with *B. Gaertner* and *Paratyphosus A* (Brion and Kayser), 41 per cent. with *Paratyphosus B* (Schottmüller), 33 per cent. with *Aertrycke* and 12 per cent. with *Paratyphosus B* (Schottmüller). Generally speaking the more typhoid agglutinin there is present, the more secondary agglutination is likely to be found.]

The application of the serum test to the identification of the typhoid bacillus.

The application of the agglutination reaction to the identification of the typhoid bacillus may be of considerable service but is not a test sufficiently delicate and specific to determine the identity of the bacillus with certainty.

For the purpose of testing whether a given organism be the typhoid bacillus or no it is better to use the serum of a person suffering from the disease which agglutinates quite distinctly in a dilution of 1 in 100 than an artificially prepared anti-typhoid serum.¹ Typical typhoid bacilli are agglutinated by this serum in dilutions varying from 1 in 50 to 1 in 100. Strains of the colon bacillus on the other hand are never agglutinated, or at most only in dilutions of 1 in 5 to 1 in 10. A postulate such as the following would render the diagnosis very simple: any bacillus agglutinated in a dilution of 1 in 50 may be legitimately described as a typhoid bacillus.

Unfortunately, it is now established that there are some undoubted typhoid bacilli which are not agglutinated by the serum of a person suffering from enteric fever. Rémy has shown that a typhoid bacillus which agglutinated well at first readily lost this property when grown symbiotically with the colon bacillus for a few weeks. Occasionally, strains of the typhoid bacillus isolated from the living body or from water can be agglutinated only with difficulty, and it is not until they have been sub-cultivated a certain number of times on artificial culture media that agglutination capacity is acquired (Courmont, Chantemesse, Rémy, Sacquépée and others). When a suspected typhoid bacillus has failed to give the serum reaction the following experiment may be carried out with the object of identifying the organism. Inoculate a guinea-pig every other day for a fortnight with 2 c.c. of a forty-eight-hour broth culture of the bacillus under investigation. If the blood of the guinea-pig now agglutinates an undoubted typhoid bacillus in a minimum dilution of 1 in 40 the organism which served for the inoculation of the animal may be regarded as a true typhoid bacillus. Some strains of undoubted typhoid bacilli however escape even this method of recognition (Rémy).

8. Absorption of agglutinins.

Castellani's absorption or saturation method can also be applied to the differentiation of the typhoid bacillus from closely allied organisms and by

¹ In the case of animals highly immunized against the typhoid bacillus, Rodet has shown that the blood not only agglutinates the typhoid bacillus in very high dilutions, but that it also has marked agglutinating properties for some strains of the colon bacillus. Pfandler, Bruns, Kayser, have shown that very highly immunized serums agglutinate not only the organism against which the animals were immunized but also closely related species.

its means it is possible to determine whether agglutinins which have been detected in a suspected typhoid serum are specific agglutinins or co-agglutinins. (For technique see p. 436.)

9. Complement fixation.

The method of complement fixation (Bordet-Gengou reaction) is applicable to the diagnosis of enteric fever and to the identification of the typhoid bacillus. The method is described at p. 233. The results are more exact and more reliable than agglutination (Widal and Le Sourd) and the reaction gives positive results with the serum of "carriers" even when no bacilli can be detected (Schöne).

[H. R. Dean finds that the complement-fixation method affords an extremely delicate and specific means of differentiating between various members of the typhoid and paratyphoid group. (For Dean's technique see p. 428).]

SECTION IV.—DETECTION, ISOLATION AND IDENTIFICATION OF THE TYPHOID BACILLUS.

The detection of the typhoid bacillus may be rendered difficult by the presence of other organisms in the fluid or tissue under examination. Thus, in patients suffering from enteric fever or in patients or animals who have died from the infection the bacillus occurs in pure culture and can be readily isolated, but when it is necessary to isolate it from water, dust, stools, etc. the presence of the colon bacillus often renders the investigation by no means easy.

The methods of isolating the typhoid bacillus from water and other sources is dealt with in a separate chapter (Chap. XXIII., p. 401) and here the more simple investigations only will be considered in which the organism is assumed to be in pure culture in a fluid or tissue of the body.

1. Microscopical examination.

For purposes of microscopical examination films and sections of the spleen and other organs as well as—in the case of experimentally infected animals—



FIG. 221.—Typhoid bacillus. Section of a spleen. Carbol-thionin. (Oc. 2, obj. $\frac{1}{4}$ th, Zeiss.)

films from the pus of typhoid abscesses and the peritoneal exudate, should be made.

In no case can an absolute diagnosis be made on microscopical evidence alone.

(a) **Films.**—Films should be stained first with methylene blue or carbol-thionin and then by Gram's method.

Films from the spleen often contain only a few organisms, but if the tissue be first incubated films made from it will be found to be very rich in bacilli. Wash the surface of the organ in a 1 in 1,000 solution of perchloride of mercury, wrap it up in a cloth wrung out of the same solution and incubate at 37° C. for 24 hours (Cornil); or if preferred a little of the pulp may be drawn up into a number of Pasteur pipettes and incubated (Gasser).

Gasser prefers to stain the films obtained in this way by Gram's method, using dilute carbol-fuchsin as a counterstain: the typhoid bacilli and the groundwork are then stained red while if any gram-positive organisms are present they are, of course, stained violet.

(b) **Sections.**—Fix the tissues to be cut in alcohol or acid perchloride solution (p. 189) and embed in paraffin. Stain the section by any of the methods applicable to the staining of gram-negative organisms—preferably with thionin or by Nicolle's tannin method (p. 217).

2. Cultures.

Culture media—broth, agar (and, for isolating the bacillus when contaminations are present, gelatin plates)—should be sown with scrapings from the spleen, with fluid exudates, products from puncture of the tonsil, urine collected under aseptic precautions, etc.

Attention has already been drawn (p. 198) to the dangers attending puncture of the spleen in the living subject. This practice should never be resorted to as a matter of routine and since the serum reaction is now available for the purposes of diagnosis (see p. 384) and the bacilli can be isolated from the blood there is no justification for running the risk attending the operation.

Examination of the blood. (a) **Courmont's method.**—Collect the blood aseptically by puncture of a vein at the bend of the elbow (p. 193) and sow 2-4 c.c. immediately in a large volume (200-300 c.c.) of ordinary broth. Incubate at 37° C. If no turbidity appears after 24 hours shake the flask to promote the growth of the organism and then incubate again, and examine the culture daily. In some cases, when the typhoid blood has powerful agglutinating properties growth may be delayed, being invisible until the third or fourth day, and may then occur solely as clumps in the deposit which forms at the bottom of the liquid.

(b) **Busquet's method.**—To minimize the inconvenience caused by the agglutinating and bactericidal properties of the blood, Busquet sows a number of flasks each containing 250 c.c. of peptone broth with a few drops only of blood.

Sacquée and Perquis adopt the additional precaution of defibrinating the blood as it leaves the vein.

(c) **Lafforgue's method.**—Lafforgue eliminates the serum, which contains the bactericidal substances. The blood is rendered non-coagulable by the addition of sodium citrate (2 drops of a 1 in 5 solution of sodium citrate to 2 c.c. of blood) and then centrifuged. The deposit only is sown in broth in the proportion of 20 c.c. of broth to the deposit from 2 c.c. of blood. Under these conditions the typhoid bacillus grows rapidly.

(d) **Conradi's method.**—Conradi has shown that bile is an excellent medium, since it renders the blood non-coagulable and inhibits its bactericidal action. Cultures in bile-containing media are recommended for the detection of the typhoid bacillus in blood.

The principle may be applied in different ways. The simplest methods are those of Zeidler and Kayser.

1. Methods of Zeidler and Kayser.—Zeidler adds 1 c.c. of blood (30 drops

to 5 c.c. of ox bile previously sterilized in the autoclave. The mixture is incubated at 37° C. for 12-24 hours and then plated out on malachite green agar (p. 409) or better, litmus-lactose-agar.

Kayser adopts a similar technique and sows 2.5 c.c. of fresh blood in 5 c.c. of sterile ox bile and then plates on Conradi-Drigalski's medium (p. 407).

2. Conradi's technique.—Conradi uses ox bile containing 10 per cent. of peptone and 10 per cent. of glycerine. The mixture is sterilized at 100° C. for 2 hours. A small clot of the suspected blood is added to 5 c.c. of the sterilized medium and incubated at 37° C. for about 15 hours. Plates of litmus-lactose-agar are then sown with the cultures.

3. Roosen-Runge's technique.—Glycocholate of sodium is used instead of bile. The medium is an ordinary agar medium to which 10 grams per litre of glycocholate of sodium have been added.

4. Dünschmann's technique.—Dünschmann is of opinion that the valuable constituent in bile is taurocholate and not glycocholate of sodium. He recommends the following medium :

| | |
|-----------------------------------|-----------|
| Gelatin, | 5 grams. |
| Agar, | 30 " |
| Lactose, | 40 " |
| Peptone, | 10 " |
| Taurocholate of sodium, | 20 " |
| Water, | 1000 c.c. |

When only a small quantity of blood is available it is used for sowing surface plates on bile-salt-agar.

Detection in sputum.—To detect the typhoid bacillus in sputum employ one of the methods described in Chap. XXIII.

CHAPTER XXII.

BACILLUS COLI.

Introduction.

Section I.—Experimental inoculation, p. 394.

Section II.—Morphology and cultural characteristics, p. 395.

Section III.—Biological properties, p. 396.

1. Bio-chemical reactions, p. 396.
2. Variability of flagella, p. 398.
3. Vitality and virulence, p. 398.
4. Toxin, p. 398.
5. Vaccination and serum therapy, p. 399.
6. Agglutination, p. 399.

Section IV.—Detection, isolation and identification of the colon bacillus, p. 400.

The bacillus of green diarrhœa, p. 400.

In man and the lower animals the colon bacillus, which was originally described by Escherich, is a normal inhabitant of the alimentary canal where it makes its appearance a few hours after birth.

In the intestines of healthy human subjects the colon bacillus is associated with numerous other micro-organisms (at least fifty different species are present, many of them being anaërobes); it is also frequently found in the mouth—twenty-five out of sixty-five cases (Grimbert and Choquet).

Though often only slightly virulent when isolated from the healthy intestine, the colon bacillus in certain circumstances and in a diseased environment may acquire a high degree of virulence, as for instance in all febrile conditions, in enteric fever, and in the majority of diseases of the intestine; and may then act as the causal agent of a number of diseases affecting man.

It is, for instance, the cause of secondary infections in enteric fever, dysentery and cholera.

In some cases of septicæmia the colon bacillus is the organism present in the blood, and while as a rule bacillæmic conditions due to it are not severe, they may on occasions present all the clinical features of enteric fever. The bacillus is also the cause of some attacks of enteritis, of some cases of choleraic and infantile diarrhœa, etc. Peritonitis may sometimes be due to the colon bacillus (as, for instance, peritonitis resulting from perforation of the gut or following strangulated hernia, and peritonitis unaccompanied by perforation). Invading the biliary passages this organism determines suppurative cholangitis and possibly infective jaundice, and is responsible for some cases of sore throat, broncho-pneumonia, endocarditis, pericarditis, and meningitis. It is the causal agent in a number of infections of the urinary passages and must be identified with the *urinary bacillus of Clado*. In women it plays an important part in determining pathological conditions of the true pelvis (such as salpingitis and metritis). Finally it is responsible for most *post mortem* and *agonic ante mortem* infections.

The colon bacillus is found in the soil, in water contaminated with animal excreta, and in dust.

SECTION I.—EXPERIMENTAL INOCULATION.

The colon bacillus is [usually] pathogenic to guinea-pigs, rabbits, mice, and other animals. Though often avirulent when isolated from the stools of healthy persons, its virulence can be rapidly increased by passing it through the peritoneal cavities of a series of guinea-pigs. Guinea-pigs are the most suitable animals for the study of the experimental disease.

A virulent strain may easily be obtained by suturing the anus of a guinea-pig. The animal dies of intestinal obstruction, and a pure culture of a very virulent colon bacillus can be isolated from the cloudy peritoneal exudate. Should the exudate as is sometimes the case contain a few other organisms mixed with the colon bacillus, a pure culture of the latter can be readily obtained by plating on gelatin.

Sub-cutaneous inoculation of a colon bacillus of low virulence into guinea-pigs, rabbits or mice leads, as a rule, to the formation of an abscess which resolves spontaneously. Intra-peritoneal inoculation produces a more severe, but not usually fatal infection.

The inoculation of a virulent strain, on the other hand, usually gives rise to an acute disease in these animals: the effects will be described in detail.

1. Guinea-pigs. (*a*) **Intra-peritoneal inoculation.**—The inoculation of a few drops of a broth culture into the peritoneal cavity causes death in about 20 hours with symptoms of sub-acute peritonitis and a sub-normal temperature. *Post mortem*, there is a generalized peritonitis with a copious, turbid exudate: the coils of the intestine are covered with a purulent fibrinous exudate: the lumen of the gut is filled with diarrhoeal matter, the walls are swollen and congested and occasionally show some mucous ecchymoses, the Peyer's patches are swollen and the spleen enlarged; in females the organs of generation are congested and it is not uncommon to find the uterus filled with an hæmorrhagic exudate. The organism can be isolated from the blood and internal organs.

(*β*) **Intra-pleural inoculation.**—Death supervenes in 24 hours. *Post mortem* there is an excess of fluid, sometimes blood-stained, in the pleura, with fibrinous deposit on the lungs, pericardial effusion, congestion of the lungs and intestine and swelling of the spleen. The bacillus is present in the blood and internal organs.

(*γ*) **Sub-cutaneous inoculation.**—This leads to a less severe infection than the preceding and much larger doses of culture (1-2 c.c.) are required to produce a fatal result. A swelling forms at the site of inoculation, the bacillus becomes disseminated and death takes place in 48 hours. *Post mortem* the Peyer's patches and the spleen are swollen and the intestine congested and ecchymosed.

2. Mice.—Mice, though less susceptible, succumb to the inoculation of cultures of the bacillus. The lesions are similar to those in guinea-pigs.

3. Rabbits.—Rabbits also are less susceptible than guinea-pigs, and much larger doses must be used to produce death; *post mortem* the lesions are similar in the two cases.

When a small dose is inoculated sub-cutaneously the animal does not die for several days and *post mortem* suppurative foci will be found in the liver, spleen and mesenteric glands.

Intra-venous inoculation usually leads to a rapidly fatal infection; the rabbit suffers from a colon bacillæmia resulting in the production of the usual lesions in the walls of the intestine and spleen.

Sometimes the animal may survive the intra-venous inoculation of a few drops of a broth culture for several months. In such cases an atrophic paralysis appears as

the result of an *anterior poliomyelitis* (Gilbert and Lion); this affection of the cord is not necessarily fatal, and the rabbits sometimes recover even though the symptoms may have been very marked.

SECTION II.—MORPHOLOGY.

1. Microscopical appearance.

The colon bacillus, like the typhoid bacillus, is a small rod-shaped organism with rounded ends. Morphologically, the two organisms are identical and subject to the same variations; spindle-shaped forms and pseudo-sporing forms are met with equally in the two cases.

Staining methods.—Like the typhoid bacillus, the colon bacillus is gram-negative and stains with the ordinary dyes.

Motility.—As a rule, the colon bacillus is less motile than the typhoid bacillus.

The motility varies greatly in strains from different sources; in some cases indeed the bacilli are non-motile, in others the movements are slow and limited, while in others again the organisms are almost as motile as the typhoid bacillus.

Flagella.—The flagella of the colon bacillus offer many points of contrast with those of the typhoid bacillus. They can be stained by the same methods as the latter but successful preparations are more difficult to obtain.

The number of flagella is always smaller than in the case of the typhoid bacillus: the colon bacillus has usually about four to six flagella and it is quite the exception to find as many as twelve.

The flagella may be arranged all round the surface [peritrichous]: but more commonly they are seen arranged in one or two bunches attached to points on the surface, generally towards one end [lophotrichous]. The flagella rarely exceed $3-5\mu$ in length being only an half to a third as long as those of the typhoid bacillus: they are not so wavy and undulating and are never seen in the tangled bunches so characteristic of the typhoid bacillus.

2. Cultural characteristics.

A. Conditions of growth.—The conditions under which growth takes place are the same for the typhoid and colon bacilli: both are able to grow at 45°C ., but given equal opportunities the colon bacillus grows rather more quickly. Its growth is accompanied by an unpleasant faecal odour which is characteristic of the organism.

B. Characteristics of growth on various media. 1. **Broth.**—In cultures incubated at 37°C . growth is visible in 6–8 hours and has in general the same characteristics as the growth of the typhoid bacillus; a greyish pellicle however often forms on the surface of the medium which is only exceptionally seen in cultures of the typhoid bacillus.

2. **Gelatin.**—The colon bacillus does not liquefy gelatin.

(a) **Stab cultures.**—In cultures incubated at 20°C . growth is visible in 24 hours. The small colonies which form along the line of the stab become opaque and soon unite to form a continuous line of growth. On the surface, a thick whitish pellicle of creamy consistence forms and may extend to the side of the tube. In short, the growth of the colon bacillus is, as a rule, both more copious and more rapid than that of the typhoid bacillus but the differences may not be very marked and cannot be relied upon for purposes of differentiation.

(b) **Stroke culture.**—After incubating for 30 hours a thin, bluish layer with pinked edges appears which subsequently becomes whitish and opaque.

In typical cases, the growth is more abundant and more opaque than that of the typhoid bacillus.

(γ) *Isolated colonies*.—As a rule, isolated colonies are small and lenticular and their margins indented; at first they are bluish and transparent but later become white and opaque and are larger than those of the typhoid bacillus. Frequently, however, the colonies remain transparent and preserve the "iceberg" appearance already noted as characteristic of the typhoid bacillus.

Colonies which develop in the depth of the gelatin have the appearance of small whitish opaque grains.

3. Agar and coagulated serum.—On these media the colon bacillus forms a whitish layer with no characteristic feature. Gas-bubbles sometimes form in the depth of the medium and increasing in size lift up the medium.

4. Potato.—As a rule, the growth is at first yellowish and then later becomes brown, thick, raised and moist; but some strains of the colon bacillus give a thin colourless pellicle indistinguishable from the growth of the typhoid bacillus. The quality and variety of the potato used have much to do with the appearance of the growth.

On Rémy and Sugg's solid medium the colon bacillus invariably gives rise to an abundant, thick growth which may be glairy or dry and which is always of a dirty yellow or brown colour.

5. Milk.—Milk is coagulated in 24–30 hours when incubated at 37° C.

SECTION III.—BIOLOGICAL PROPERTIES.

1. Biochemical reactions.

1. Action on carbohydrates.—In both aërobic and anaërobic culture the colon bacillus decomposes lævulose, lactose, saccharose, maltose, glucose, erythrite, and mannite, with the formation of acid (formic, acetic, butyric, lactic), gas (hydrogen, carbon-dioxide), and ethyl alcohol. These reactions are invaluable for the purpose of identifying the organism. The technique has been described in connexion with the action of the typhoid bacillus on sugars (p. 373).

Attention must be drawn to the fact that the colon bacillus under certain conditions, particularly when it is grown in symbiosis with the typhoid bacillus (Rémy), may lose its power of splitting up sugars with the formation of acid and gas. Grimbert and Legros have found however, that in some cases where dysgonic influences have affected the fermentation properties of the colon bacillus these properties though markedly diminished, are not altogether lost; they have been able to show, for instance, that milk will be coagulated if in a shallow layer, and that lactose if present in sufficient quantity is feebly, but nevertheless definitely attacked.

(a) Action on lactose-broth containing calcium carbonate.—When sown on this medium and incubated at 37° C. for 12–20 hours the colon bacillus decomposes the lactose with the formation of acids, which in turn attack the calcium carbonate and give rise to numerous bubbles of carbon-dioxide.

(b) Action on litmus in presence of a carbohydrate fermented by the organism.—Litmus-lactose-gelatin and litmus-mannite-gelatin. The blue colour of the litmus is first changed to red and later assumes a peculiar colour somewhat resembling that of the skin of an onion.

(c) Action on Grimbert and Legros' medium (p. 373).—The colour of the medium is rapidly changed to red.

(d) Milk.—Milk is rapidly coagulated (*vide* p. 373).

[(e) Litmus milk.—The litmus is first turned pink and subsequently bleached.]

Numerous more or less ingenious methods have been devised to illustrate the fermentation properties of the colon bacillus. Thus for instance, to an agar or other medium containing lactose, a substance (*e.g.* fluorescein) is added which is altered or intensified in colour by the acids formed out of the lactose: in other cases a reagent is selected for addition to the medium which is coloured in alkaline solutions but colourless in acid solutions (*e.g.* phenol-phthalein). Ramond's method may be described as an example.

(f) **Ramond's method.**—Take a tube of gelatin containing 4 per cent. of lactose and after melting it—being careful not to apply too much heat—add sufficient aqueous solution of acid fuchsin (Rubin S.) to impart a red-cerise colour to the gelatin, then just decolourize with a saturated aqueous solution of sodium carbonate—2–3 drops are sufficient—filter, sterilize at 105° C. for 5 minutes and pour the now colourless medium into a sterile Petri dish. The typhoid bacillus produces no change of colour when sown on this medium, while on the other hand the colon bacillus, in virtue of the acids formed from the lactose which neutralize the sodium carbonate, regenerates the red tint so that a characteristic rose-coloured area develops around colonies of this organism. This method is not so delicate as that with litmus-tinted media.

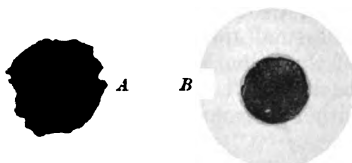

FIG. 222.—Appearances presented by the typhoid bacillus (A) and the colon bacillus (B) when grown on Ramond's agar. (After Gauthié.)

2. Action on neutral red.—Neutral red in culture media is reduced and decolorized by the colon bacillus. The typhoid bacillus has no action on the dye.

Liquefy a tube containing 10 c.c. of ordinary agar (or glucose-agar), add 3 or 4 drops of a sterile saturated aqueous solution of neutral red, and when the medium has cooled and set sow it with the colon bacillus in stab culture and incubate at 37° C. for 24 hours. The medium will now no longer be red but will exhibit a greenish fluorescence, and on further incubation this will soon change to a canary yellow colour. This reaction has been adapted by Savage to the detection of the colon bacillus in water (p. 411).

3. Indol formation.—An important and very constant characteristic of the colon bacillus is the formation of indol in culture media.

The value of the indol reaction in the diagnosis of the colon bacillus has been called in question by some authors on the ground that they not infrequently fail to find any indol in cultures of this organism: and Rémy has shown that when the colon bacillus is grown with the typhoid bacillus the former may lose its capacity to produce indol.

Recent work demonstrates that the negative results obtained by the earlier observers were due to the imperfections of their technique. "The property of producing indol is far less variable than is generally believed," and the indol reaction furnishes one of the best tests there is for identifying the organism, provided that the following precautions be observed, viz. :—

1. That peptone water and not ordinary broth be used as the culture medium.
2. That the culture be examined between the third and the eighth day but never later.
3. That the test be performed exactly as described at p. 374.

4. Cultures on synthetic media.—The colon bacillus as a rule grows luxuriantly in the different liquid media of Nægeli, Maasse, Fränkel, Rémy and Sugg (p. 375).

5. Growth on vaccinated media.—If the colon bacillus be sown on a tube of agar or gelatin on which the typhoid bacillus has already been grown and scraped off as described above, some amount of growth generally takes place which though distinct is less abundant than on tubes of new media.

6. Growth on coloured media.—The colon bacillus decolorizes both

Noeggerath's medium and fuchsin-agar. The typhoid bacillus gives similar results.

7. Growth on arseniated broth.—A typical colon bacillus grows in broth containing as much as 2 grams of arsenious acid per litre (Thoinot and Brouardel).

8. Growth on artichoke.—A typical colon bacillus grows luxuriantly on artichoke, and turns the medium green (p. 375).

9. Growth on media containing caffeine.—The colon bacillus does not grow on media containing 0.5 per cent. of caffeine (p. 408).

10. Growth on malachite-green media.—According to Loeffler the addition of a small quantity of malachite-green to culture media prevents the growth of the colon bacillus, but does not interfere with the growth of the typhoid bacillus. As a matter of fact, the colon bacillus grows on media containing either malachite green or crystal violet (pp. 409 and 407).

2. Variability of flagella.

The variability of the flagella is very limited, their characteristics being little influenced by antiseptics, temperatures unfavourable to growth, etc. (Rémy and Sugg).

Examination of the flagella should never be neglected when it is desired to identify the colon bacillus.

3. Vitality and Virulence.

Vitality.—All that has been said with regard to the vitality of the typhoid bacillus is equally applicable to the colon bacillus.

Virulence.—The virulence of the colon bacillus is subject to great variation (*vide* experimental inoculation, p. 394).

4. Toxin.

Malvos has shown that porcelain-filtered broth cultures are toxic. Broth cultures also yield a toxic precipitate when heated with sulphate of ammonia. As a rule, the toxin is not very harmful and large doses of filtered cultures must be inoculated to produce a fatal result in experimental animals.

The inoculation of a large dose of toxin into the ear-vein of a rabbit produces the following symptoms: At first there is muscular weakness, sub-normal temperature, drowsiness and coma: later, convulsions set in and finally a generalized tetanic condition which continues till the animal dies (Gilbert). A smaller dose produces a chronic intoxication with diarrhœa, drowsiness and wasting, the animal often dying of cachexia.

In guinea-pigs, the inoculation of large quantities of toxin into the peritoneal cavity is followed by a sub-normal temperature and leads to collapse and death (Boix). The blood may contain organisms (especially the colon bacillus) which have found their way from the intestinal canal (Achard and Renault).

Colilysin.—In suitable media the colon bacillus forms an hæmolytic substance (Kayser).

Colilysin is only produced in any quantity if the broth has a markedly acid reaction (80 c.c. of decinormal oxalic acid per litre).

The hæmolysin is present after incubating for 2 days at 37° C. but continues to increase in amount until the fourth day and remains at its maximum until the end of the second week.

Colilysin is a powerful solvent of dog red-cells; it has less action on horse, ox, and rabbit cells, and very little and in some cases no action at all on the

red cells of other animals (man, guinea-pigs, birds etc.). Colilysin can be kept for months at the ordinary temperature of the laboratory and is not destroyed by heating to 120° C. for half an hour.

Some normal serums (those of man, the horse etc.) neutralize the hæmolytic property of colilysin: and an anti-colilysin can be readily produced by inoculating various animals sub-cutaneously with four-day old broth cultures of the colon bacillus.

5. Vaccination and serum therapy.

Guinea-pigs and rabbits can be immunized by repeatedly inoculating them either with small doses of living and virulent organisms or with filtered cultures of similar strains. Albarran and Mosny produced a very high degree of immunity in dogs and rabbits by repeatedly inoculating them with small doses of filtered cultures and with the filtrates derived from macerating the internal organs of animals dead of a colon bacillus infection. Rodet immunized horses and sheep by inoculating them repeatedly with increasing doses of living or dead cultures.

The serum of vaccinated animals has marked immunizing properties and also, to some extent, therapeutic properties. These properties are manifested against the strains used for immunization but may be wanting against strains from other sources.

Antityphoid serum is neither prophylactic nor curative for the colon bacillus.

According to the experiments of Sanarelli and some other observers animals vaccinated against the colon bacillus should be immune to both the colon and typhoid bacilli, and the serum of the animals should immunize against the typhoid bacillus. These results have however not been confirmed.

6. Agglutination.

(a) The serum of animals infected with the colon bacillus or immunized against that organism, as well as the serum of persons suffering from infections due to the colon bacillus, have the property of agglutinating the bacillus. The agglutination reaction is always obtained with the strain producing the infection, but the results are often negative if other than the infecting organism be employed for the reaction, though the latter may be an authentic colon bacillus. This method of diagnosis cannot therefore be relied upon. The capacity of the colon bacillus to agglutinate is increased to a very marked extent by sub-culturing it on artificial media (Rodet).

(b) The colon bacillus is not agglutinated by the serum of animals vaccinated against the typhoid bacillus nor by the serum of persons suffering from enteric fever. But for this reaction to be of any value it is important that certain precautions be observed (*vide* footnote on p. 389).

All human serums whether taken from enteric fever patients or not exert a slight agglutinating action on the colon bacillus when diluted five or ten times. Unless this fact be borne in mind it may lead to error. All mistakes may be avoided by adopting the following methods.

Determine carefully first of all the agglutinating power of the typhoid serum which is to be used in the reaction: then mix a drop of the highest dilution of the serum which will definitely agglutinate the typhoid bacillus with a culture of the colon bacillus. Thus, for example, if the highest dilution in which a given typhoid serum will agglutinate the typhoid bacillus be 1-100 this dilution of the serum should be used in testing the suspected colon bacillus. Under these conditions the agglutination of the colon bacillus is never observed, and the serum reaction can be employed as an excellent means for differentiating the two organisms provided that it be always remem-

bered that a strain of the typhoid bacillus which is not agglutinated by a typhoid serum may very occasionally be encountered.

SECTION IV.—DETECTION, ISOLATION AND IDENTIFICATION.

The methods of detecting the colon bacillus in the tissues and fluids of the body are similar in principle to those employed for the detection of the typhoid bacillus. These methods as well as the differentiating tests, etc. are fully dealt with in Chap. XXIII.

It must be remembered that the colon bacillus often multiplies in the body immediately after death, and even during the last few hours of life: the finding of the colon bacillus in the tissues or fluids under these conditions is therefore of no diagnostic value whatever.

The bacillus of Green Diarrhoea.

According to Lesage and Thiercelin the bacillus of green diarrhoea is merely a chromogenic variety of the colon bacillus. The organism is found in practically pure culture in the stools of children suffering from the disease.

Experimental inoculation.—The organism is only slightly pathogenic for laboratory animals. Rabbits, when inoculated intra-venously or fed with cultures of the bacillus, suffer from an attack of green diarrhoea from which they recover in a few days.

Microscopical appearance.—Morphologically the bacillus is a short rod-shaped organism with rounded ends in every way similar to the colon bacillus.

Cultures.—The bacillus of green diarrhoea is a facultative aërobe. It grows on all the ordinary media and gives rise to a disagreeable odour. The green colouring matter is only produced in aërobic culture.

A pure culture is very easily obtained by plating a trace of the stool of an infected child on gelatin.

Broth.—At first the medium is uniformly cloudy but later a greenish sediment is deposited.

Gelatin is not liquefied. In stab culture, the bacillus gives rise to a scanty whitish growth in the substance of this medium and on the surface to a small greenish lenticular pellicle. On sloped gelatin, the growth is poor, greenish in colour and has a tendency to spread away from the line of sowing: after a few days the gelatin is tinted uniformly green. Isolated colonies form small greenish granular points.

On agar.—The growth is poor, greenish in colour and spreading. The agar acquires a green tint.

On potato.—The growth is luxuriant, covers the whole surface of the medium and is of a dirty green mucous appearance.

Milk is rapidly coagulated.

Carbohydrate media are strongly fermented.

CHAPTER XXIII.

THE ISOLATION OF THE TYPHOID AND COLON BACILLI FROM WATER, STOOLS, ETC. AND THE METHODS OF IDENTIFYING THE TWO ORGANISMS.

Introduction.

Section I.—The isolation of the typhoid and colon bacilli, p. 402.

1. Original methods, p. 402. 2. Elsner's method and its modifications, p. 403. 3. Precipitation methods, p. 406. 4. Method based upon the motility of the typhoid bacillus, p. 406. 5. Chantemesse's carbolic media, p. 407. 6. Conradi-Drigalaki's method, p. 407. 7. Endo's medium, p. 408. 8. Caffeine media, p. 408. 9. Malachite green media, p. 409. 10. China green medium, p. 410. 11. Bile media, p. 410. 12. Brilliant green medium, p. 411. 13. Neutral red media, p. 411. 14. Methods based upon agglutination, p. 412. 15. MacConkey's media, p. 412.

Section II.—The identification of the typhoid and colon bacilli, p. 412.

THE isolation of the typhoid bacillus from water, etc. in which it is mixed with other species of organisms, and especially when the colon bacillus is also present, presents certain difficulties which may be summed up under four headings.

1. On gelatin media, at the ordinary temperature of the atmosphere, colonies of the typhoid bacillus develop slowly (requiring about 48 hours) while saprophytic organisms which liquefy the medium grow more quickly and so put an end to the investigation.

2. The colon bacillus very often retards the growth of the typhoid bacillus when the two organisms are sown together on artificial culture media, with the result that the presence of the latter may pass unnoticed. There is, in fact, a true antagonism between the colon bacillus and the typhoid bacillus (Grimbert). A similar antagonism also exists between certain other micro-organic species and the typhoid bacillus when sown together on artificial media (Besson).

3. Rémy, though he does not admit that the typhoid bacillus is crowded out by the colon bacillus, nevertheless lays stress on the difficulty of isolating the former when the latter organism is also present. He shows that by growing the two organisms together their properties may be profoundly modified: thus the typhoid bacillus occasionally loses its property of being agglutinated by a specific serum, and the colon bacillus may under like conditions lose its indol-producing and fermentation properties.

4. The ordinary method of gelatin-plating only permits of a very small quantity of a suspected water being sown and it is therefore possible that if the typhoid bacillus be present only in small numbers as compared with other organisms, it may escape notice.

It is not a matter for surprise therefore to find that much experimental work has been done with a view to perfecting a method or methods of detecting with certainty the presence of the typhoid bacillus in material in which it may be suspected to occur.

SECTION I.—THE ISOLATION OF THE TYPHOID AND COLON BACILLI.

1. Original methods.

Under this heading will be briefly considered various methods which though in use until recently do not give dependable results, being practically useless for detecting the typhoid bacillus when the latter is mixed with the colon bacillus. These methods are now almost entirely discarded.

(a) **Rodet's method.**—Rodet showed that the typhoid and colon bacilli would grow at 45° C. while most other organisms failed to do so, and on this fact based the following method of analysis. To a flask containing sterilized broth he added 20–100 c.c. of the suspected water and incubated at 45° C. for 20–24 hours. If on taking the flask out of the incubator the broth was cloudy a strong presumption was raised that the typhoid or colon bacillus or both were present in the water. Microscopical examination of the culture and, if need be, isolation on gelatin plates removed all doubt.

(b) **Method of Chantemesse and Widal.**—Chantemesse and Widal found that both typhoid and colon bacilli would grow in artificial media containing 2·5 grams of carbolic acid per litre, and utilized the fact in order to detect these organisms in water.

To tubes containing 20 c.c. of liquefied gelatin add 1 c.c. of a 5 per cent. solution of carbolic acid and a few drops of the water to be examined and pour plates. Unfortunately a certain number of organisms develop in the plates which, as they grow, liquefy the medium and consequently soon put an end to the experiment. A large number of plates must be sown with each of the suspected samples because only a very small amount of water can be used for each plate.

(c) **Vincent's method.**—Vincent devised a method, which for a long time was in general use, based upon a combination of the two preceding observations. He used broth containing 0·1 per cent. of carbolic acid as the culture medium and incubated the cultures at 41·5°–42° C.

To each of half-a-dozen tubes containing 10 c.c. of broth add, immediately before use, 5 drops of a 5 per cent. solution of carbolic acid. Sow with 0·5–1 c.c. of the suspected water, cover with india-rubber caps to prevent evaporation of the carbolic acid, and incubate at 41·5° or 42° C. If the medium in any of the tubes becomes cloudy after incubating for 12 or 20 hours, transfer a little of the culture to a fresh tube of carbolic-broth and incubate it similarly at 41·5° C. As a rule, when the suspected water contains the colon bacillus the first sub-culture yields a pure growth of the latter organism. It must, however, be borne in mind that some saprophytes (*Bacillus subtilis*, *Bacillus mesentericus*, *B. luteus*, the white streptococcus of water, *Proteus vulgaris*, etc.) will also grow under these conditions. These latter organisms cannot be excluded by further sub-cultivation in carbolic-broth because once they become accustomed to carbolic media they grow in them just as well as the colon bacillus. A watered silk appearance in the tubes is a fairly reliable indication of the presence of the colon or typhoid bacillus, but the investigation must always be carried further by microscopical examination and isolation on gelatin. It is well to remember that in carbolic-broth the colon and typhoid bacilli often occur as very short rods (cocco-bacilli) arranged in pairs and devoid of motility.

(d) **Method of Péré.**—This is merely Vincent's method modified in such a way as to allow large quantities of the suspected water to be examined.

Prepare a concentrated broth (meat, 1000 grams, water 1000 grams, and peptone 50 grams), distribute in quantities of 50 c.c. in a series of flasks, and autoclave.

To each flask add 3 c.c. of a 5 per cent. solution of carbolic acid and 100 c.c. of the suspected water. Sow five or six flasks and incubate them at 41° C. As soon as the medium becomes cloudy (15–20 hours) sow a series of broth tubes each containing 0·1 per cent. carbolic acid with a trace of the growth from any of the flasks that may be cloudy. Incubate at 41° C. and continue the experiment as in Vincent's method.

(e) **Method of Pouchet and Bonjean.**—This also is a modification of Vincent's method. To each of a series of flasks containing 100 c.c. of sterile broth add 150 c.c. of the water to be examined and 5 c.c. of a 5 per cent. solution of carbolic acid. Incubate at 42° C.

If the medium becomes cloudy in any of the flasks sow sub-cultures for three generations in 0.1 per cent. carbolic acid broth and incubate at 42° C. Finally, sow a tube of ordinary broth from the last carbolic broth culture, incubate at 36° C. for 8 days and then inoculate a guinea-pig with 0.3 c.c. of culture per 100 grams of animal. If the animal die sow cultures with fragments of the internal organs and heart blood.

The five methods just described are available for the isolation of the typhoid bacillus provided that the colon bacillus is not also present but if, as is most often the case, the two organisms are present together the isolation of the former is impossible by these means.

2. Elsner's method and its modifications.

A. Elsner's method.

The method is available according to Elsner for the isolation of the typhoid bacillus from sources such as water or stools in which the colon bacillus is also present.

The technique is based upon the fact that the typhoid and the colon bacilli grow, to the exclusion of most other organisms, on a potato-jelly containing iodide of potassium. Disappointing results are however frequently obtained; sometimes the plates are rapidly liquefied and the experiment brought to an end; at other times the typhoid bacillus cannot be found even though it has been purposely introduced into a sample of water as a control. Several attempts have been made to improve the method, and these will be considered subsequently.

Technique. A. Isolation from water.—1. Prepare and sterilize :—(i) a number of tubes each containing 10 c.c. of potato gelatin (p. 41).

(ii) The following solution :—

| | | | | | | | | | | |
|-------------------|---|---|---|---|---|---|---|---|----|--------|
| Distilled water, | - | - | - | - | - | - | - | - | 50 | grams. |
| Potassium iodide, | - | - | - | - | - | - | - | - | 10 | ” |

2. Immediately before use, melt the potato-gelatin tubes and add 1 c.c. (20 drops) of the iodide solution.

The gelatin will then contain 1 per cent. of iodide.

3. Sow ten to fifteen tubes each with 0.5 or 1 c.c. of the suspected water and plate.

4. According to Elsner, the colon bacillus appears on these plates as early as the second day (at 22° C.) as circular, opaque, slightly brown colonies while the typhoid bacillus does not develop until the plates have been incubated for 4 days and then as smaller, transparent, barely visible colonies. Other organisms fail to grow.

As a matter of fact, various organisms other than the typhoid and colon bacilli, and some of which liquefy the gelatin, do grow on the medium; and then again the colonies of the typhoid bacillus are not so easily differentiated as Elsner makes out. It must be distinctly realized that Elsner's medium possesses no specific property which ensures the development of the typhoid and colon bacilli to the exclusion of other organisms. Its only advantage is that it allows the typhoid bacillus an equal opportunity with the colon bacillus to grow. It is necessary, therefore, to examine carefully every colony on the plates which does not liquefy the medium and which does not form pigment. This is easily done by transferring them each to a separate tube of broth and then incubating at 37° C. After incubating for 24 hours the morphology of the organisms is determined by examining the cultures microscopically and only those tubes which show short, gram-negative bacilli with rounded ends need be reserved for the further tests to be described later.

If any of the broth cultures prove to be impure they must be plated out again on Elsner's jelly. Sow a loopful of the broth in a fresh tube of the jelly, a drop of this on a second tube, and three drops of the second into a third tube (p. 77).

B. Isolation from stools.—The technique to be adopted in this case is similar to that just described. Dilute a loopful of the stool in a tube of sterile water and use a drop of the dilution to sow a tube of Elsner's gelatin: mix thoroughly and transfer a drop to a second tube and from the second tube two or three drops to a third tube. Pour plates and incubate. All the non-liquefying colonies which develop must be picked off for further investigation in the manner described above.

B. Grimbert's method.

Grimbert attributes the failure of Elsner's method partly to the want of uniformity of the medium due to variations in the chemical composition of potatoes, and partly to the fact that Elsner did not test the reaction of his medium. According to Grimbert the addition of iodide of potassium is not essential: ordinary gelatin can be used if the reaction be such that 10 c.c. are neutralized by 5 c.c. of lime water, though it is better to have a medium of constant chemical composition. Grimbert's medium is used in the same way as Elsner's, but the colonies are more slow in developing and the earliest do not appear before the third day. The method, as a matter of fact, has hardly any advantage over Elsner's original method.

Technique.—To 1,000 c.c. of water add:—

| | |
|---|----------|
| Maltose, - - - - - | 1 gram. |
| Soluble starch, - - - - - | 2 grams. |
| Asparagin, - - - - - | 2 " |
| Neutral phosphate of potassium, - - - - - | 2 " |
| Potassium sulphate, - - - - - | 2 " |
| Magnesium sulphate, - - - - - | 2 " |
| Ammonium bimalate, - - - - - | 2 " |
| Magnesium carbonate, - - - - - | 1 gram. |

Dissolve 15 per cent. of gelatin in the mixture, clear with white of egg, heat to 115°, filter, and test the reaction thus: dilute 10 c.c. of the gelatin with 50 c.c. of warm distilled water, add a few drops of an alcoholic solution of phenol-phthalein, then run in lime water until a permanent rose pink colour is obtained. If more than 3 c.c. of lime water are required to neutralize the gelatin reduce the acidity by the addition of a small quantity of normal soda solution until 10 c.c. of the gelatin are neutralized with 5 c.c. of lime water.

Immediately before use 1 per cent. of iodide or bromide of potassium may be added.

C. Rémy's method.

Rémy suggests the use of a medium which is more nutritive and less acid than Grimbert's. By means of his "differential gelatin" he has been able to isolate the typhoid bacillus from stools in all the cases of enteric fever which he has investigated.

This "differential gelatin" has no greater selective property than Elsner's medium and the majority of micro-organisms grow in it. Still, liquefying species are to some extent checked and the inhibiting influence of the colon bacillus on the typhoid bacillus is not apparent on this medium.

Technique.—Preparation of the "differential gelatin." To a litre of water in a flask add:

| | |
|--------------------------------|-----------|
| Asparagin, - - - - - | 6 grams. |
| Oxalic acid, - - - - - | 0.5 gram. |
| Lactic acid, - - - - - | 0.15 " |
| Citric acid, - - - - - | 0.15 " |
| Di-sodium phosphate, - - - - - | 5 grams. |
| Potassium sulphate, - - - - - | 1.25 " |
| Sodium chloride, - - - - - | 2 " |
| Witte's peptone, - - - - - | 30 " |

Heat to 110° C. for 15 minutes, and on taking the flask out of the autoclave pour the boiling liquid into another flask containing 120–150 grams of best quality gelatin. Shake the flask until the gelatin is dissolved, add soda solution until the mixture is slightly alkaline, heat in the autoclave again to 110° C. for 15 minutes, then add sufficient half-normal sulphuric acid¹ to render the medium acid to such an extent that 10 c.c. require the addition of 0.2 c.c. of half-normal solution of soda to neutralize;² mix by shaking well, then heat in the steamer at 100° C. for 10 minutes and filter.

¹ A normal solution contains 98 grams H₂SO₄ per litre.

² This acidity is equivalent to 0.5 gram of H₂SO₄ per litre.

After filtration, test the reaction again thus: mix 10 c.c. of gelatin with 100 c.c. of distilled water, add a few drops of phenol-phthalein solution, and from a 1 c.c. pipette graduated in tenths of a cubic centimetre run in a half-normal solution of soda; the red colour should appear when 0.2 c.c. of the solution have been added.

The desired degree of acidity being obtained, dissolve 2.5 grams of magnesium sulphate for every litre of gelatin. Tube in quantities of 10 c.c. and sterilize on three successive occasions at 100° C.

Immediately before use add to each tube 1 c.c. of a sterile 35 per cent. solution of lactose and 0.1 c.c. of a 2.5 per cent. solution of carbolic acid.

Method of sowing.—Rémy's gelatin is used in the same way as Elsner's. It is advisable, first of all, to sow the suspected water in a broth containing 0.5 per cent. of sulphuric and carbolic acids, and after incubating at 30° C. for 24 hours to use this culture for sowing the gelatin plates by the dilution method. Colonies of the colon and typhoid bacilli appear in the plates after incubating for 2 days.

Cultural characteristics. *The colon bacillus.*—Colonies in the depth of the medium are rounded, ovoid or fusiform and of a yellowish-brown colour. Minute bubbles of gas are occasionally formed. Colonies on the surface which are sometimes transparent and bluish at first, rapidly become opaque: some of them are hemispherical and of a yellowish-brown colour while others have irregular margins and tend to spread.

The typhoid bacillus.—In the depth of the medium the colonies are bluish-white, smaller than the colonies of the colon bacillus and form no gas. Surface colonies are not well seen until the third day: at first "they are rather like moulds in appearance" but later spread out, become more bluish in colour and may attain the size of a threepenny-piece.

The differences between the colonies of the typhoid and colon bacilli are frequently very slight and many sub-cultures may have to be made before the nature of the organism can be definitely determined.

D. Besson's method.

Elsner's gelatin method has two great disadvantages. In the first place, it is only available for the analysis of small quantities of water even though the number of plates used be large—which is in itself a disadvantage—and, secondly, the medium does not prevent the growth of saprophytic organisms, which sometimes liquefy the plates as early as the second day and so put an end to the experiment. With the object of simplifying and at the same time rendering the method more efficient as a means of water analysis, Besson, in 1896, introduced certain modifications which he claims improve it in that they rapidly eliminate saprophytes and permit the use of large volumes of water.

1. Weigh out 30 grams of peptone (Chapoteaut) and 5 grams common salt, add a litre of water and dissolve in the steamer; then, without neutralizing, heat in the autoclave to 115° C., filter, tube in quantities of 10 c.c. and sterilize at 115° C.

2. When an experiment is to be done, take ten tubes of the peptone water and to each add 20–30 drops of freshly prepared Gram's iodine solution (p. 143) and 10 c.c. of the water to be examined.

The amount of iodine solution to be added varies a little with the composition of the peptone. The first few drops will be rapidly decolorized but when about 20–25 drops have been added the medium assumes a pale brownish-pink colour which disappears in 5–6 minutes. When this occurs sufficient iodine has been added.

3. Incubate the tubes at 37°–38° C. Under these conditions the colon bacillus produces a visible growth in 8–12 hours and the typhoid bacillus in about 15–20 hours while other organisms do not appear until later. The tubes should be examined at frequent intervals.

4. After incubating for 18 hours pick out the tubes which are cloudy and sow sub-cultures in iodine-peptone-water.

5. Incubate the latter for 15 or 20 hours then plate a few drops from each tube on litmus-lactose-agar. At the same time sow sub-cultures in ordinary broth for inoculation later.

6. The plates are to be examined and the colonies tested as described above.

With this method Besson has succeeded in isolating the colon bacillus, the typhoid bacillus, and Friedländer's bacillus from water.

3. Methods based on precipitation.

When a chemical precipitate is produced in a liquid containing micro-organisms, a large proportion of the latter are carried down mechanically with the precipitate, so that if the latter be collected the organisms originally present in the liquid are concentrated in a small volume. The principle here involved is the basis of several methods for the detection of the colon and typhoid bacilli in water. Their only advantage is in the concentration of the micro-organisms, since the nature of the organisms and the presence of the typhoid bacillus can only be definitely established by carrying out a series of experiments on ordinary lines using the precipitate as the original material.

A. Vallet's method.—Pour 20 c.c. of the water under examination into a sterile tube, add 4 drops of a saturated aqueous solution of hyposulphite of sodium and 4 drops of a saturated solution of lead nitrate. A precipitate forms which carries down with it the majority of the organisms present in the water (the chemicals used have no bactericidal action on the typhoid bacillus). Centrifuge the mixture and suspend the deposit in a few drops of the hyposulphite solution. Sow the liquid—which now contains all the organisms originally present in the 20 c.c. of water—on Elsner's gelatin (*vide ante*).

B. Schueder's method.—In Schueder's method the fluid is not centrifuged. Pour 2 litres of the water under examination into a tall vessel and add 20 c.c. of a 7.75 per cent. solution of hyposulphite of soda and 20 c.c. of a 10 per cent. solution of lead nitrate. Mix intimately and allow to stand for 20 hours. Decant the supernatant liquid and suspend the precipitate in 14 c.c. of a saturated solution of hyposulphite. Sow the emulsion in quantities of 0.5 c.c. on a number of litmus-lactose-agar plates.

C. Ficker's method.—Ficker precipitates the organisms with sulphate of iron. To 2 litres of the suspected water add 8 c.c. of a 10 per cent. solution of soda and 7 c.c. of a 10 per cent. solution of sulphate of iron. The precipitation takes 2 or 3 hours to complete. Centrifuge the precipitate and dissolve the deposit in one-half its volume of a 25 per cent. solution of neutral tartrate of potassium. Sow the solution on Conradi and Drigalski's medium by the dilution method (p. 407).

D. Müller's method.—The precipitation is effected by means of oxychloride of iron which acts more quickly than the sulphate and does not require that the water shall be made alkaline.

To 3 litres of the water under examination add 5 c.c. of the oxychloride solution. Precipitation is complete in about half an hour. Collect the precipitate on a filter and sow, without re-dissolving, either on Conradi-Drigalski plates or, better (Nicter), on malachite-green-agar plates (p. 409).

4. Method based on the motility of the typhoid bacillus.

Cambier, in examining water for the presence of typhoid bacillus, relies upon the property possessed by the organism of rapidly passing through porous membranes (p. 155).

Place a porous porcelain bougie in a large test-tube. Half fill both the bougie and the tube with ordinary broth, and sterilize in the autoclave. Sow the suspected water in the lumen of the bougie and incubate at 37° C. As soon as the broth in the test-tube becomes cloudy sow a little of it on any of the ordinary media used for differentiating the typhoid bacillus.

This method is not very reliable since some strains of the colon bacillus also pass

very rapidly through the walls of a porous bougie, and the various modifications of the method which have been introduced seem to have little to recommend them.

5. Chantemesse's methods.

Chantemesse has introduced two methods of isolating the typhoid bacillus, both of which depend upon obtaining surface colonies on carbolic agar. For isolating the organism from stools and water the second is not only more rapid but is simpler.

First method.—Filter 5 or 6 litres of the suspected water through a Chamberland bougie. Wash the surface of the filter in 200 c.c. of a 3 per cent. peptone solution. Incubate the latter at 37° C. and arrange the culture so that air can be bubbled through it while incubating. Add more peptone solution at the end of 12 hours and again at the end of 24 hours. Then centrifuge the culture. The typhoid bacilli being motile and isolated (i.e. not grouped in clumps) remain in suspension while non-motile organisms and those massed together in zooglea masses go to the bottom of the vessel. With the supernatant liquid sow a number of Esmarch's roll tubes by the dilution method using carbolic-agar as the medium.

Carbolic-agar.—Dissolve 30 grams of peptone and 20 grams of agar in a litre of water, and make feebly alkaline (p. 31), tube in quantities of 10 c.c. and sterilize. Immediately before use melt the agar and add four drops of a 5 per cent. solution of carbolic acid to each tube (=0.1 per cent. of carbolic acid).

Incubate the cultures at 37° C. Growth appears in about 16–20 hours. Sow all colonies at all resembling the typhoid bacillus on the various media used for differentiating the organism.

Second method (recommended).—Sow the suspected material directly on litmus-lactose-carbolic-agar.

Litmus-lactose-carbolic-agar.—Prepare agar as above and add 2 per cent. lactose. Tube in quantities of 10 c.c. and sterilize. Just before use melt a number of tubes of lactose-agar and to each add 1 c.c. of sterile neutral litmus solution and 4 drops of a 5 per cent. solution of carbolic acid. Mix thoroughly, pour into Petri dishes in thin layers (1–2 mm. deep) and allow to set.

Dip a fine sterile badger-hair brush in a tube of sterile water to which a trace of the suspected stool has been added, and without recharging it sow in succession six surface plates of litmus-lactose-carbolic-agar.

If water is to be examined, filter it through a Chamberland bougie and sow litmus-lactose-carbolic-agar plates with the deposit left on the bougie. For spreading the plates use a glass rod bent at a right angle (Drigalski's spatula).

Incubate the plates at 37° C. and after 12–15 hours numerous colonies will be found on the plates some red (the colon bacillus) and some blue (the typhoid bacillus). Test the blue colonies by the agglutination reaction.

6. Conradi-Drigalski's method.

This method, in principle the same as that of Chantemesse, is in very general use in Germany.

The suspected material is sown on the surface of agar containing lactose and litmus. Crystal-violet is used in place of the carbolic acid in Chantemesse's medium, and is found to be just as effective in restraining the majority of organisms while allowing the growth of the colon and typhoid bacilli.

Conradi and Drigalski's medium.

(a) **Preparation.**—Macerate 1500 grams of minced beef in 2 litres of water for 24 hours: boil the mixture for an hour: filter: make up to 2 litres with water: add—

| | | | | | | | | | | |
|------------------|---|---|---|---|---|---|---|---|----|--------|
| Peptone (Witte), | - | - | - | - | - | - | - | - | 20 | grams. |
| Nutrose, | - | - | - | - | - | - | - | - | 20 | " |
| Salt, | - | - | - | - | - | - | - | - | 10 | " |

boil, add 60 grams of agar; heat until the agar is dissolved: make feebly alkaline

to litmus paper: autoclave for an hour at 120° C., filter in the steamer and sterilize for a quarter of an hour at 115° C. Prepare

| | | | | | | |
|-----------------------------|---|---|---|---|---|-----------|
| Litmus solution (Kahlbaum), | - | - | - | - | - | 300 c.c. |
| Lactose, - | - | - | - | - | - | 30 grams. |

Sterilize at 100° C. for 15 minutes.

Mix the agar and litmus solution while they are both hot. If the colour of the litmus indicate that the medium is acid add sufficient 10 per cent. soda solution to render it faintly alkaline and then a further 4 c.c. of warm 10 per cent. solution of sodium hydroxide. Lastly, add to the mixture, 20 c.c. of a hot sterile (0·1 per cent.) solution of crystal-violet B, Höchst.

(β) **Mode of use.**—Pour the Conradi-Drigalski agar carefully, without contaminating it, into large Petri dishes (15–20 cm. in diameter). Sow the suspected material on the surface of the agar (*vide ante* Chantemesse's method). Incubate the plates at 37° C. The typhoid bacillus gives blue transparent colonies and the colon bacillus red opaque colonies.

Hagemann's medium.

This is a modification of the preceding.

| | | | | | | |
|---------------------------|---|---|---|---|---|-----------|
| Liebig's extract (Lemco), | - | - | - | - | - | 10 grams. |
| Peptone (Witte), | - | - | - | - | - | 10 " |
| Salt, | - | - | - | - | - | 3 " |
| Water, | - | - | - | - | - | 600 c.c. |

Boil. Add 500 c.c. of milk. Boil and dissolve 20 grams of agar in the hot liquid. Heat to 120° C. in the autoclave for half an hour. Filter in the steamer and distribute in Erlenmeyer flasks. Sterilize. When required for use, liquefy the agar, make slightly alkaline with soda solution, add a few cubic centimetres of litmus and finally three drops of a 1 per cent. alcoholic solution of crystal violet.

7. Method of Endo.

The principle of the method depends upon the fact that if sulphite of sodium be added to agar containing fuchsin the medium is decolourized, and if the decolourized medium be sown with the colon bacillus the acids produced by the organism restore the colour of the fuchsin and the colonies of the organism acquire a red colour, while under similar conditions the colonies of the typhoid and paratyphoid bacilli are colourless.

The agar medium of Endo is used in exactly the same way as Chantemesse's and Conradi-Drigalski's agar. It is very easy to prepare and gives good results.

Prepare a litre of peptone broth in the ordinary way, add 30 grams of agar and dissolve in the steamer. Filter. Make absolutely neutral to litmus paper then add 10 c.c. of a 10 per cent. solution of sodium bicarbonate.

Add 10 grams of chemically pure lactose, and 5 c.c. of a filtered saturated alcoholic solution of fuchsin which imparts a red colour to the medium. Now add 25 c.c. of a freshly prepared 10 per cent. solution of sodium sulphite. Decolourization commences at once and is complete after sterilization. Distribute in quantities of 15 c.c. in tubes, sterilize at 115° C. and store in the dark. When required for use melt the agar and pour into Petri dishes.

After incubating for 15 hours at 37° C. colonies of the colon bacillus on this medium have red centres and after 24 hours are entirely red with a greenish iridescence.

8. Methods based on the use of caffeine.

As already mentioned (p. 375) Roth has shown that the addition of 0·5 per cent. of caffeine to culture media checks the growth of the colon bacillus but does not interfere with that of the typhoid bacillus. This fact has been successfully applied by Roth, Hoffmann and others to the isolation of the typhoid bacillus from water and stools. According to Courmont and Lacomme however, the method is uncertain since some strains of the typhoid bacillus do not grow on caffeine-containing media. The results should always be controlled by some other method.

Both's technique.—Prepare broth in the ordinary way and add sufficient soda solution to give a permanent pink colour with phenol-phthalein. Add 80–100 c.c. of a 1 per cent. solution of caffeine to every 100 c.c. of broth.

Sow the fluid with the material to be examined and incubate at 37° C. for 24 hours, then plate traces of the culture on gelatin.

Ficker's technique.—To 100 c.c. of a 3 per cent. peptone-meat-broth add 0.6 gram of pure caffeine and 0.0007 gram of crystal-violet (0.7 c.c. of a 0.01 per cent. solution). Sow the fluid with the suspected material, incubate at 37° C. for 12 or 13 hours and sow Conradi-Drigalski plates with the culture obtained.

Lubenau's technique.—Lubenau sows in 100 c.c. of Ficker's broth containing 0.3 per cent. of caffeine, incubates for 13 hours, adds 100 c.c. of broth containing 0.6 per cent. of caffeine, incubates for a second period of 13 hours and adds 100 c.c. of broth containing 0.9 per cent. of caffeine. Before and after the second addition of broth he sows surface plate cultures on litmus-lactose-caffeine-agar for purposes of isolation.

Lubenau's caffeine-agar.—Prepare a litre of 6 per cent. peptone-beef-broth, dissolve 40–60 grams of agar in the broth, make neutral to litmus, heat to 120° C., filter and sterilize. After sterilization and while the agar is still hot add 60 c.c. of litmus solution, 5 grams of lactose and finally 110 c.c. of a 6 per cent. solution of pure caffeine. Distribute in Petri dishes.

Gathgens' technique.—To a litre of Endo's medium add 33 c.c. of a 10 per cent. solution of pure caffeine. Distribute in tubes in quantities of 15 c.c. which can afterwards be used to prepare plates.

9. Malachite green media.

Loeffler has stated that the addition of a certain quantity of malachite green to culture media impedes the development of the colon bacillus while having no effect on the growth of the typhoid and paratyphoid bacilli.

Unfortunately malachite green media are not so selective as Loeffler believed, for though the growth of a large number of organisms (*streptococci*, *staphylococci*, cholera vibrios, etc.) is inhibited the colon bacillus will often grow (Kiralyfi).

These media are difficult to prepare; if too much green be added the typhoid bacillus is inhibited, if too little, the colon bacillus grows as rapidly as the typhoid bacillus. It is essential to use a chemically pure compound and the amount to be added to the agar varies very much with the different commercial preparations. A series of experiments should be done to determine the quantity (1 in 4,000 to 1 in 6,000) to be added (Lentz and Tietz, Schindler). These different complications render the method of little practical value, and to make it more efficient Loeffler has recently advised the addition of ox bile to his malachite green media (*vide infra*). As the result of his own experience Firth concludes that methods based upon the use of malachite green are inferior to Conradi-Drigalski's method.

Growth on malachite green media diminishes the agglutinability of the typhoid bacillus.

Of the different malachite green methods Leuch's seems to be the best.

Leuch's technique.—Prepare an agar medium with:—

| | |
|------------------------|------------|
| Beef, - - - - - | 500 grams. |
| Water, - - - - - | 1 litre. |
| Common salt, - - - - - | 5 grams. |
| Dextrin, - - - - - | 10 " |
| Agar, - - - - - | 30–40 " |

Neutralize, using litmus as the indicator. Add 5 c.c. of a normal solution of sodium carbonate and 100 c.c. of a 10 per cent. solution of nutrose. After filtering and sterilizing add 16–18 c.c. of a 1 per cent. solution of malachite green.

Surface cultures are sown in Petri dishes (p. 407). Colonies of the typhoid bacillus destroy the colour of the medium and a characteristic yellowish zone forms around them.

To identify an organism isolated on this medium Loeffler advises the use of a so-called *typhoid solution*.

Loeffler's typhoid solution.—This fluid is coagulated by the typhoid bacillus in 16–24 hours and floating on the coagulum is a clear green liquid. The colon bacillus produces not an homogeneous coagulum but a greenish mass adhering to the sides of the tube.

The solution consists of :

| | | | | | | | | | |
|--|---|---|---|---|---|---|---|-----|--------|
| Distilled water, | - | - | - | - | - | - | - | 100 | c.c. |
| Nutrose, | - | - | - | - | - | - | - | 1 | gram. |
| Glucose, | - | - | - | - | - | - | - | 1 | " |
| Peptone, | - | - | - | - | - | - | - | 2 | grams. |
| Lactose, | - | - | - | - | - | - | - | 5 | " |
| 2 per cent. solution of chemically pure malachite green, | - | - | - | - | - | - | - | 1 | c.c. |
| Normal soda solution, | - | - | - | - | - | - | - | 1.5 | " |

Peabody and Pratt's technique.—Sow the suspected fluid in broth containing 0.1 per cent. of malachite green, incubate at 37° C. for 18 hours and isolate on Conradi-Drigalski plates.

10. Method based upon the use of China green.

[Werbitzki recommends the addition of China green to agar (1.4–1.5 c.c. of a 0.2 per cent. solution per 100 c.c. of agar) for the purpose of restraining the growth of the colon bacillus when attempting the isolation of the typhoid and paratyphoid bacilli from such material as stools.]

11. Methods based on the use of bile.

The adjuvant properties of bile for the typhoid bacillus have been applied to the detection of the bacillus in water and stools. Bile may be used alone (either as such or in the form of bile salts) or mixed with malachite green.

Dünschmann's technique.—Prepare the following medium :

| | | | | | | | | | |
|-------------------------|---|---|---|---|---|---|---|-----|--------|
| Distilled water, | - | - | - | - | - | - | - | 100 | c.c. |
| Agar, | - | - | - | - | - | - | - | 3 | grams. |
| Peptone, | - | - | - | - | - | - | - | 3 | " |
| Lactose, | - | - | - | - | - | - | - | 3 | " |
| Gelatin, | - | - | - | - | - | - | - | 1 | gram. |
| Taurocholate of sodium, | - | - | - | - | - | - | - | 1 | " |

Heat to 120° C. Filter and distribute the medium in tubes in quantities of 10 c.c. After sterilization, add 1 c.c. of a sterile solution of litmus to each tube.

To use the medium, pour the contents of four or five tubes into a similar number of Petri dishes and with a Drigalski's spatula (p. 407) charged with the suspected material—and without recharging—sow surface cultures on each dish.

Jackson and Mella's technique.—The suspected material is enriched by growing in ox bile and the culture used to sow plates of Hesse's agar.

Hesse's agar.—In a litre of boiling water dissolve :

| | | | | | | | | | |
|-------------------|---|---|---|---|---|---|---|-----|--------|
| Liebig's extract, | - | - | - | - | - | - | - | 5 | grams. |
| Peptone, | - | - | - | - | - | - | - | 10 | " |
| Sodium chloride, | - | - | - | - | - | - | - | 8.5 | " |
| Agar, | - | - | - | - | - | - | - | 30 | " |

Heat to 120° C., filter, distribute in tubes (10 c.c. in each) and sterilize in the autoclave.

Method.—Sow the suspected material in 5 c.c. of bile and incubate at 37° C. for 24 hours. Take eight test-tubes each containing 9 c.c. of sterile water: to the first add 1 c.c. of the bile culture, to the second 1 c.c. of the first, to the third 1 c.c. of the second and so on. Take eight tubes of Hesse's agar, liquefy the medium and to one add 1 c.c. of the first dilution to the second 1 c.c. of the second dilution and so on, and pour plates.

Loeffler's technique.—A mixture of bile and malachite green is used. Sow the material on plates of Leuchs' nutrose-agar (p. 409) containing 3 per cent. of ox bile and 1.9 per cent. of a 0.2 per cent. solution of malachite green.

Padlewsky's technique.—This method also depends upon the use of a mixture of bile and malachite green. Sow on plates prepared with the following medium :

| | |
|----------------------------|----------|
| Distilled water, - - - - - | 100 c.c. |
| Agar, - - - - - | 3 grams. |
| Peptone, - - - - - | 3 " |
| Ox bile, - - - - - | 5 " |
| Lactose, - - - - - | 1 gram. |

The medium should be slightly alkaline to litmus. After sterilization cool to 65° C. and add, firstly a mixture of

| | |
|--|----------|
| 1 per cent. aqueous solution of malachite green, - - - | 0.5 c.c. |
| Ox bile, - - - - - | 0.5 " |

then,

| | |
|--|--------|
| 10 per cent. aqueous solution of sulphite of sodium, - - - | 1 c.c. |
|--|--------|

12. Method based upon the use of brilliant green.

Conradi substitutes for malachite green a mixture of *Brillantgrün-Kristall* and picric acid. An agar containing these dyes favours the growth of the typhoid and paratyphoid bacilli while inhibiting that of most other organisms. The colon bacillus either does not grow at all or only in very small numbers.

Prepare a slightly modified Hesse's agar :

| | |
|-----------------------------|-----------|
| Water, - - - - - | 1 litre. |
| Peptone, - - - - - | 10 grams. |
| Agar, - - - - - | 30 " |
| Liebig's extract, - - - - - | 20 " |

Make alkaline, heat and filter. For every 1.5 litres of agar add

| | |
|--|---------|
| 0.1 per cent. aqueous solution of <i>Brillantgrün-Kristall</i> (extra pure, Höchst), - - - - - | 10 c.c. |
| 1 per cent. aqueous solution of picric acid, - - - - - | 10 " |

On this medium, the colonies of the typhoid bacillus are bright green and transparent and thicker in the centre than at the margins : colonies of the paratyphoid bacilli are larger, and yellowish-green in colour.

13. Method based upon the use of neutral red.

Savage has applied the property possessed by the colon bacillus of reducing neutral red to the detection of that organism in water (p. 397).

The method is only applicable to the detection of the colon bacillus and does not indicate the presence of the typhoid bacillus.

The reduction of neutral red, however, is not, as was formerly thought to be the case, a specific property of the colon and paratyphoid bacilli : *B. pyocyaneus*, *B. fluorescens*, *B. enteritidis* and some of the harmless saprophytic organisms found in water give fluorescence in Savage's neutral-red broth ; while, on the other hand, some strains of the colon bacillus exert hardly any decolourizing action on neutral red (Sicre, Vincent). Savage's method is therefore unreliable.

Savage's technique.—Prepare broth thus :—

| | |
|------------------|------------|
| Water, - - - - - | 1 litre. |
| Beef, - - - - - | 250 grams. |

Boil, make up to 1 litre and add

| | |
|-------------------------------|-----------|
| Peptone (Defresne), - - - - - | 20 grams. |
| Common salt, - - - - - | 20 " |
| Glucose, - - - - - | 5 " |

Boil, cool, decant and add 10 c.c. of a 5 per cent. solution of neutral-red. Distribute in tubes and sterilize. The medium should be ruby-red in colour.

Method of analysis.—Sow a number of tubes of the medium with different quantities (1 c.c. to 10 c.c.) of the suspected water. Incubate at 37° C. for 24 hours. The presence of the colon bacillus is indicated by a beautiful green fluorescence or a canary yellow tint according as to whether the water contains few or many colon bacilli.

14. Methods based on the agglutination of the typhoid bacillus.

Chantemesse, Windelbandt, Schepilewsky have made use of the agglutinating properties of antityphoid serum for isolating the typhoid bacillus. This method is very delicate and permits of the isolation of the bacillus from mixtures in which it is present in great dilution.

Windelbandt's technique.—To 10 c.c. of sterile broth add 1 c.c. of the water under examination. Incubate the mixture for 3–5 days. By this time the growth is very abundant, the broth is cloudy and the surface covered with a pellicle. Remove the surface growth and add to the remainder a few drops of a powerfully agglutinating anti-typhoid serum. The agglutinated typhoid bacilli fall to the bottom of the tube. Centrifuge the broth culture, collect the deposit and dilute it with a little normal saline solution. Sow litmus-lactose-agar plates with the diluted deposit.

Chantemesse's technique.—A simple method devised by Chantemesse consists in adding 30 grams of peptone to 1 litre of the suspected water, neutralizing and incubating for 20 hours. If little clumps form filter through paper and add anti-typhoid serum to the filtrate. After standing for 2 hours decant the liquid, filter the deposit through paper, and sow the clumps retained on the filter on Chantemesse's agar (p. 407).

Altschüller's technique.—Altschüller adds peptone and salt to the suspected water and incubates for 24 hours. Ten c.c. of the culture are now transferred to a test-tube the lower end of which is drawn out and opened and attached to a piece of india-rubber tubing closed by a clip. A few drops of a typhoid immune serum are added and a precipitate is soon formed which collects in the narrow drawn-out part of the tube. By releasing the clip the deposit can be run into a tube containing sterile peptone water. The mixture is shaken and then incubated at 37° C. The typhoid bacillus grows rapidly and is unaccompanied by other organisms.

[15. MacConkey's media.]

[The basis of MacConkey's media consists of a stock solution composed of :

| | | | | | | |
|-----------------------------------|---|---|---|---|---|-----------|
| Sodium taurocholate (commercial), | - | - | - | - | - | 0.5 gram. |
| Peptone (Witte), | - | - | - | - | - | 20 grams. |
| Distilled water, | - | - | - | - | - | 100 " |

For liquid media there is added to this stock solution 0.5 per cent. of a 1 per cent. solution of neutral red and 0.5 per cent. of glucose or 1 per cent. of the other carbohydrates or alcohols, as the case may be, and the medium is distributed into Durham's fermentation tubes and sterilized in the steamer for 10 minutes on each of two days, great care being taken not to overheat the medium. If it be thought advisable white of egg may be used to clear the medium.

[Bile-salt-agar is made by dissolving 1.5–2 per cent. agar in the stock solution. This is best done in the autoclave. The medium is cleared with white of egg and filtered. After filtration the same amount of neutral red is added as in the case of the liquid media (MacConkey).

[A consideration of the fermentation reactions of the various organisms shows that by the use of certain carbohydrates or alcohols either alone or in combination organisms can be separated by means of colour reactions. MacConkey's medium forms a most useful nutritive medium to which to add these substances.]

SECTION II.—THE IDENTIFICATION OF THE TYPHOID AND COLON BACILLI.

(i) An organism may be suspected to belong to the typhoid-colon group if it have the following characteristics :

1. A bacillus with rounded ends, generally motile, decolourized by Gram's method, having no capsule [and not forming spores].

2. Cloudiness with a watered-silk appearance in broth culture.

3. No liquefaction of gelatin.

(ii) If conforming to these requirements it remains to determine if the organism (which must of course be investigated in pure culture) be a typhoid or colon bacillus.

It is now that difficulties arise, though if what has been said in the foregoing chapters be recalled it seems impossible to confuse typical specimens of the two organisms. The motility, the characters of the flagella, the appearance of the growth on potato, the indol reaction, a study of the fermentation properties and the agglutination test should furnish a sure means of diagnosis.

Unfortunately some strains of the colon bacillus readily lose—when grown, for instance, symbiotically with the typhoid bacillus (Rémy) or a *Pasteurella* (Lesage), etc.—their capacity to produce indol and some of their fermentation properties; other strains are very motile, while others again yield a very scanty growth on potato and on gelatin grow like the typhoid bacillus. Similarly, some strains of the typhoid bacillus are only slightly motile, and their flagella can only be stained with difficulty: others give a slightly pigmented growth on potato resembling cultures of the colon bacillus: finally, when grown in the presence of the colon bacillus or after passing through human tissues some strains lose their characteristic property of being agglutinated by antityphoid serum. Hence a certain amount of confusion arises which is further increased by the existence of a whole group of bacilli very closely related to the typhoid bacillus and having properties intermediate between it and the colon bacilli (paratyphoid bacilli, Chap. XXV.).

It will therefore be clear that for accurate diagnosis it is necessary to study several of the characteristics of the organism. The table below gives a list of the tests on which the diagnosis should be based. The investigation of the fermentation reactions, the production of indol, the characters of the flagella and the agglutinating properties will in the majority of cases afford sufficient information upon which to determine whether the organism is a typhoid or a colon bacillus. When an organism has all the characteristics of the typhoid bacillus except that it is not agglutinated by an antityphoid serum it must be tested as indicated under 14 in the table. If the serum of a guinea-pig which has been inoculated every other day for a fortnight with 2 c.c. of a forty-eight-hour old broth culture of the organism under investigation agglutinates an authentic typhoid bacillus in a dilution of at least 1 in 40 (Rémy) the organism must be regarded as a strain of the typhoid bacillus. Finally the two last tests (15 and 16) in the table will be found very valuable and should permit of the identification of the organism in even the most difficult cases.

| METHOD OF DIAGNOSIS. | COLON BACILLUS. | TYPHOID BACILLUS. |
|--|---|--|
| 1. Culture in carbonated lactose-broth. | Abundant gas-formation (12–36 hrs.). | No gas formation. |
| 2. Stroke culture on litmus-lactose-gelatin. | The colour of the litmus is first changed to red then to a pale brown along the stroke. | The colour of the litmus is unchanged. |
| 3. Single colonies on litmus-lactose-agar. | Red colonies. | Blue or violet colonies. |

| METHOD OF DIAGNOSIS. | COLON BACILLUS. | TYPHOID BACILLUS. |
|---|--|--|
| 4. Growth in milk. | Coagulation in 24 - 36 hours. ¹ | No coagulation. |
| 5. Growth on potato. | Thick brownish growth (inconstant). | Thin colourless glazed growth (inconstant). |
| 6. Action on neutral-red. | Reduced. | Not reduced. |
| 7. Growth on artichoke. | Abundant growth, the medium becoming green (inconstant). | No apparent growth. No change in colour of medium. |
| 8. Growth on the synthetic media of Nœgeli, Rómy and Sugg, Fränkel and others. | Copious and rapid growth (inconstant). | A poor growth appearing slowly (inconstant). |
| 9. Growth in peptone water. | Indol. | No indol. |
| 10. Single colonies on de-colourized fuchsin-agar (Endo). | Red colonies. | Colourless colonies. |
| 11. Growth on (a) Caffeine media. (b) Malachite green. | No growth (possible exceptions). | Growth (possible exceptions). |
| 12. Flagella. | Flagella short and few in number (3 to 4 on each bacillus). | Numerous (8-18), long, wavy, undulating flagella. |
| 13. Action of anti-typhoid serum (using the serum in its highest agglutinating dilution). | No agglutination. | Distinct agglutination (possible exceptions). ² |
| 14. Serum of a guinea-pig immunized with the organism. | The serum does not agglutinate a true typhoid bacillus in a dilution of 1 in 40. | The serum agglutinates a true typhoid bacillus in a dilution of 1 in 40 (some possible exceptions). |
| 15. Simultaneous inoculation of anti-typhoid serum. | If the bacillus is virulent the simultaneous inoculation of antityphoid serum does not protect the animal. | If the bacillus is virulent, the simultaneous inoculation of anti-typhoid serum protects the animal. |
| 16. Complement fixation. | No deviation of complement with a heated antityphoid serum. | Complement is deviated with a heated anti-typhoid serum. |

¹ Should no coagulation occur sow the bacillus in a shallow layer of milk. Some strains of the colon bacillus only coagulate milk under these conditions.

² Typhoid bacilli recently isolated from the body occasionally fail to agglutinate until they have been sub-cultured several times in broth.

CHAPTER XXIV.

THE PNEUMOBACILLUS OF FRIEDLÄNDER.

Introduction.

Section I.—Experimental inoculation, p. 416.

Section II.—Morphology, p. 416.

Section III.—Biological properties, p. 417.

Section IV.—Detection and isolation of the pneumobacillus, p. 418.

The bacillus of rhinoscleroma, p. 418.

The bacillus of ozæna, p. 419.

THOUGH the pneumobacillus is not—as Friedländer believed—the infecting agent in acute lobar pneumonia, it nevertheless occupies an important place in human pathology and may be the cause of any of the following diseases, viz. : broncho-pneumonia, pericarditis, pleurisy, peritonitis meningitis, otitis, parotiditis, dacryocystitis, stomatitis, orchitis, and epididymitis ; and is further responsible for many suppurative conditions. Ch. Nicolle and Hébert have drawn attention to the fact that some cases of pseudo-membranous sore throats are due to the pneumobacillus ; it is also associated at times with the diphtheria bacillus ; and finally, it may occasionally cause an hæmorrhagic type of septicæmia (Weichselbaum, Netter).

It is present in the saliva of many persons (4·5 per cent. according to Netter). In the circumambient media the bacillus appears to be widely distributed ; Uffelmann found it in the air, Emmerich in dust, Grimbert in water, Besson in samples of water from many and various sources.

No valid distinction can now be drawn between the pneumobacillus and the bacillus described by Escherich as the *Bacillus lactis aërogenes* : the proof of their identity was sketched by Denys and Martin and extended by Grimbert and Legros.¹ These researches were confirmed by Bertarelli ; he considered the *Bacillus lactis aërogenes* to be merely a variety of the pneumobacillus.

The *Bacillus lactis aërogenes* has been found in stools, in soil, water, and air. It is one of the causes of the fermentation of milk and seems to be responsible for some cases of enteritis in breast-fed children. It plays an important rôle in urinary infections (Morelle, Worsburg, Heyse, etc.).

¹ Without enlarging upon the facts which have led to the conclusion that the two organisms are identical, the following characters which according to Grimbert and Legros they possess in common may just be mentioned. They are both non-motile encapsulated bacilli, do not liquefy gelatin, do not produce indol, ferment the same sugars and have the same action upon animals.

SECTION I.—EXPERIMENTAL INOCULATION.

Mice and guinea-pigs are very susceptible to the inoculation of virulent strains of the pneumobacillus (*vide infra*). Rabbits are distinctly more immune.

Mice.—If a few drops of a culture be inoculated sub-cutaneously into a mouse they lead to the formation of an abscess containing creamy,ropy pus: the bacillus then becomes generalized and the animal dies in 1–3 days. *Post mortem*, the spleen is enlarged and the bacillus can be isolated from the blood and internal organs. Intra-pulmonary inoculation results in the formation of foci of broncho-pneumonia and terminates in death.

Guinea-pigs.—Sub-cutaneous inoculation of a small dose of culture leads to the formation of an abscess at the site of inoculation. Doses of 1 c.c. of a broth culture prove fatal: an abscess forms at the site of inoculation and death supervenes more or less rapidly with lesions of broncho-pneumonia and generalization of the bacillus.

Rabbits.—A dose of several c.c. of a broth culture injected into the marginal vein of the ear of a rabbit leads to the death of the animal in a few days. The bacillus may be found in the blood and internal organs: lesions of hæmorrhagic septicæmia are sometimes present. Sub-cutaneous inoculation is followed by a less severe disease.

Ch. Nicolle and Hébert by abrading the mucous membrane of the vulva of a rabbit and infecting the abraded area produced a swelling of the labia majora which was accompanied by a white discharge rich in pneumobacilli.

Pigeons.—Pigeons are only slightly susceptible. The inoculation of very virulent strains into the peritoneum is however fatal.

SECTION II.—MORPHOLOGY.

1. Microscopical appearance.

The pneumobacillus is a rather broad, rod-shaped organism of which the length does not exceed on an average 1–2 μ . Sometimes however in cultures, besides the cocco-bacillary forms, other long and even filamentous bacilli may be seen. The bacilli are often arranged in pairs: they are non-motile and never form spores.

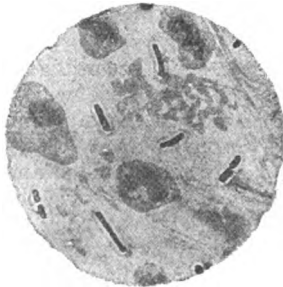

FIG. 223.—Pneumobacillus of Friedländer. Sputum. (Carbol-thionin. $\times 1000$.)

In pus, sputum and blood, the pneumobacillus has a distinct capsule. The capsule is less distinct, but can nevertheless be demonstrated, in artificial cultures on solid media (Grimbert, Nicolle and Hébert).

Staining reactions.—The pneumobacillus is easily stained by the basic aniline dyes. It is gram-negative. The capsules may be stained by the method described in the chapter dealing with the pneumococcus.

2. Cultural characteristics.

Conditions of growth.—The pneumobacillus is a facultative anaërobe and grows on all the ordinary media, which should be slightly acid for preference. Cultures can be obtained above 15° C.; the optimum temperature is about 37° C.

Characters of growth on the ordinary media. Broth.—After incubating

for 24 hours at 37° C. the medium is slightly cloudy, and on the surface a viscous pellicle is formed which makes a ring round the tube just above the surface of the liquid. On further incubation the pellicle falls to the bottom of the tube leaving the broth cloudy and viscous.

Gelatin. Stab culture.—Incubated at 20° C., a small raised white growth is formed on the surface of the gelatin after 48 hours: the growth later extends along the line of the stab and assumes a typical nail-line appearance. The medium is not liquefied. Bubbles of gas often form around the growth.

Isolated colonies.—Small round granular whitish colonies, which become somewhat raised, appear towards the third day.

Agar. Coagulated serum.—Growth on these media takes the form of a thick white viscous layer.

Potato.—A thick yellowish and viscous streak is formed and gas is also produced.

Milk.—The medium is coagulated sometimes rapidly and at other times more slowly. In the first sub-culture some strains of the bacillus do not coagulate milk but on further sub-cultivation they quickly acquire this property (Denys and Martin).



FIG. 224.—Pneumobacillus. Stab culture in gelatin. 7th day.

SECTION III.—BIOLOGICAL PROPERTIES.

1. Vitality and virulence.—Cultures of the pneumobacillus are rapidly killed at 60°–80° C., but in dry albuminous matter the bacillus is much more resistant: it seems to retain both its virulence and its vitality for a long time in water and soil. The virulence of different strains of the pneumobacillus is subject to considerable variations; it is possible that there are different varieties of the organism (the *Bacillus lactis aërogenes* would be one of these varieties, see p. 415).

2. Toxin.—Filtered cultures contain a toxin which is fatal to rabbits and produces symptoms of paralysis. *Post mortem* the intestines are congested and show small hæmorrhages.

3. Bio-chemical reactions. Indol. Nitrites.—In a neutral 3 per cent. solution of peptone the pneumobacillus does not produce indol. It forms nitrites out of nitrates.

Fermentation reactions.—The pneumobacillus ferments glycerin, and certain of the carbohydrates, viz.: glucose, galactose, arabinose, mannite, dulcitol, saccharose, lactose, maltose, raffinose and dextrin, but is without action on erythrite. Frankland has described a strain which does not ferment glycerin.

Grimbert recommends the following medium for the study of the fermentation reactions:—

| | | | | | | | | | |
|--------------------|---|---|---|---|---|---|---|---|--------------------------|
| Test substance, | - | - | - | - | - | - | - | - | 3 grams. |
| Dry peptone, | - | - | - | - | - | - | - | - | 2 " |
| Water, | - | - | - | - | - | - | - | - | 100 c.c. |
| Calcium carbonate, | - | - | - | - | - | - | - | - | <i>Quantum sufficit.</i> |

The formation of gas is naked-eye evidence of fermentation. If the calcium carbonate be omitted and litmus solution added the blue colour of the latter is changed to red during the fermentation. Glycerin is more slowly broken up.

**SECTION IV.—DETECTION, ISOLATION AND IDENTIFICATION OF
THE PNEUMOBACILLUS.**

I. In sputum.—(a) Prepare films and stain with carbol-thionin or carbol-gentian-violet. Gram's stain must also of course be used.

(b) Inoculate a mouse with a trace of the sputum.

II. In blood, pus, etc.—Microscopical examination and cultures, supplemented by the inoculation of a mouse, will render the identification of the organism easy.

III. In pseudo-membranous sore throats.—(a) Scrapings from the false membrane should be stained with a single stain and by Gram's method and examined microscopically.

(b) Cultures should be sown on coagulated serum as in the case of diphtheria. In 15–20 hours fairly large, round, greyish, viscous colonies appear which can be easily recognized with the naked eye and under the microscope.

IV. In water.—Adopt the method of cultivation in dilute carbolic acid or on peptone salt agar (Chap. LXV.). After two or three passages, pour gelatin plates on which the round raised dull white colonies of the pneumobacillus will easily be recognized. Sow one of these colonies in broth, and after 48 hours' incubation test the virulence of the culture on mice.

Differential diagnosis from the pneumococcus.—The pneumobacillus is easily differentiated from the pneumococcus by its cultural characteristics and by the fact that it is gram-negative.

Differential diagnosis from the colon bacillus.—In water examination the pneumobacillus is likely to be confused with the colon bacillus, but the mistake may easily be avoided by bearing in mind the following points.

| PNEUMOBACILLUS. | COLON BACILLUS. |
|--|----------------------------|
| Absence of motility in broth culture. | Motile. |
| Encapsulated. The capsule is very well marked in fluids and tissues, but less visible in cultures. | Non-encapsulated. |
| No indol formation in peptone water. | Forms indol. |
| Ferments glycerin. | Does not ferment glycerin. |

The bacillus of rhinoscleroma.

The bacillus of rhinoscleroma was discovered by V. Frisch. It is found in the nasal and pharyngeal lesions of rhinoscleroma, and may also multiply in the deeper tissues of the nasal fossæ. Rona found the organism in pure culture in the enlarged sub-maxillary glands in a case of the disease.

The bacillus of rhinoscleroma is very similar to the pneumobacillus: Netter and Gunther regard them as varieties of the same species. Their biological characteristics however justify their being regarded as different organisms (Paltauf and Bertarelli).

Microscopical appearance.—In sections of rhinoscleroma nodules, encapsulated cocco-bacilli resembling the pneumobacillus in shape and size are seen in the interior of certain very large cells (cells of Mickulicz) which have an excentrically placed crescent-shaped nucleus. The fluid of the nodules does not appear on microscopical examination to contain the organism, but by sowing cultures its presence can be demonstrated.

Cultures.—The bacillus of rhinoscleroma grows on all the ordinary laboratory media. Unlike the pneumobacillus it does not grow on slightly acid media, and does not ferment carbohydrates; further, its cultures are much more scanty than those of the pneumobacillus (Paltauf).

In cultures, the bacillus of rhinoscleroma always forms capsules which may be easily demonstrated by the following method. Dilute a little of the growth in a 1 per cent. solution of acetic acid, spread on a slide, dry, and stain with aniline-violet: examine in water.

On *broth, agar* and *serum*—The growth on these media is very similar to the growth of the pneumobacillus but more scanty.

On *gelatin* the growth is thread-like and very limited. The tylotate appearance so characteristic of the pneumobacillus is never produced.

On *milk*. The medium is not coagulated.

Experimental inoculation.—Laboratory animals are not susceptible to inoculation with the bacillus of rhinoscleroma.

Löwenberg's bacillus.

(*The bacillus of ozæna.*)

The bacillus found in the mucous exudates in ozæna by Löwenberg and Abel is no longer regarded as the cause of ozæna. It resembles the pneumobacillus so closely that it seems necessary to regard the two organisms as identical (Viollet, de Simoni, and others).

The microscopical appearance, the cultural characteristics and the results of inoculation are the same in both cases. The only differences between them seem to be that the bacillus of ozæna does not ferment all the carbohydrates which are fermented by the pneumobacillus and does not coagulate milk.

CHAPTER XXV.

THE PARATYPHOID BACILLI.¹ (THE PARACOLON BACILLI.)

The origin of the terms paratyphoid and paracolon, p. 420. The relation of the "paratyphoid" bacilli to the "hæmorrhagic septicæmia" group of organisms and to the "enteritidis" group, p. 421.

The origin and definition of the "Salmonella group," p. 422.

Other names suggested for the "paratyphoid group," p. 422.

The classification adopted in the following pages, p. 422.

UNDER the heading of paratyphoid bacilli are described certain organisms which in many respects resemble the typhoid and the colon bacilli: they are all gram-negative motile bacilli which do not form spores and do not liquefy gelatin. From the clinical standpoint also, though the symptoms are markedly different, there is a certain resemblance in that the diseases produced by the typhoid and paratyphoid bacilli and probably also by the colon bacillus are all primarily of a septicæmic nature.

The name **paratyphoid** was introduced by Achard and Bensaude in 1896 to describe an organism (paratyphoid B)² resembling the typhoid bacillus, which they had isolated from a case of osteomyelitis following an attack of a disease clinically indistinguishable from enteric fever, and from the urine of another case of a similar disease.

In 1897 Besson isolated a similar organism from a case of pericarditis following a disease which had been diagnosed as enteric fever.

In 1897 Widal and Nobécourt also found a similar organism (paratyphoid B)² in pus from a thyroid abscess in which there were no symptoms of a general infection. To this organism they gave the name "**para-colon**" bacillus.

Gwyn in 1898 was the first to isolate a "**para-colon**" bacillus from the blood of a person suffering from a disease clinically indistinguishable from enteric fever.

In 1900-1 Schottmüller undertook an investigation into the nature of the organisms present in the blood of cases which had the clinical symptoms of enteric fever. In addition to the typhoid bacillus he found two other species of organisms, closely related to the typhoid bacillus and to each other, to which Brion and Kayser gave the names **paratyphoid A** and **paratyphoid B**; the latter being the more frequently found. To these organisms then the term "paratyphoid" is properly applied: organisms, that is, which have many

¹ This part of the subject has been entirely rewritten.

² See Boycott, *Journal of Hygiene*, vi. 33 et seq.

of the bacteriological characteristics of the typhoid and colon bacilli and which give rise to a clinical disease having all the symptoms of enteric fever.

Further study however soon revealed the fact that these paratyphoid bacilli were, at all events in the laboratory, very closely related to if not identical with organisms which had been isolated from certain septicæmic diseases in animals accompanied by hæmorrhages—the **hæmorrhagic septicæmia group**. The first of this group to be described was that isolated by Salmon and Theobald Smith in 1885 from swine suffering from hog-cholera and known as the bacillus of hog-cholera.¹

The paratyphoid bacilli especially the B variety, had also many characteristics in common with an organism isolated by Gaertner in 1888 at Frankenhäusen from an epidemic of **food-poisoning**, and known as the *bacillus enteritidis Gaertner*.

Closely related also to the paratyphoid bacilli is an organism known as the *bacillus enteritidis Aertrycke*,² isolated in 1898 by de Nobele from an epidemic of food-poisoning at Aertrycke in Belgium and by Durham at Hatton in England. By its cultural characteristics this organism cannot be distinguished from the *bacillus enteritidis Gaertner*,³ but as Durham showed by an application of the agglutination reaction, then recently introduced, the two could be sharply differentiated.

Hence in the first quinquennium of the century a number of organisms were known which from the laboratory point of view were all very like each other, but which—and this seemed remarkable—gave rise to different diseases. The paratyphoid bacilli A and B caused a septicæmic disease clinically almost if not quite identical with enteric fever; the hæmorrhagic septicæmia group caused a septicæmia and diarrhœa in animals; while the group consisting of Gaertner's and Durham's and de Nobele's bacilli were—and still are—regarded as the cause of epidemics of food-poisoning.

It was easy to distinguish the paratyphoid A bacillus from the other bacilli mentioned both by its cultural characteristics and by its agglutination reactions. The gaertner bacillus also could by its agglutination reactions be distinguished from the aertrycke bacillus, the bacillus of hog-cholera and the bacillus paratyphoid B.

Then difficulties arose as to the nature of the three last-named organisms. The bacillus of hog-cholera was soon shown to be identical with the aertrycke bacillus; and the relationship of the latter bacillus to the paratyphoid B bacillus therefore alone remained to be determined. The position in 1906 was summarized by Boycott: "On the whole, the distinction between hog-cholera [aertrycke] and paratyphoid B, though slender, seems to be real. The morbid relations to man are different, for while the former gives rise to a sudden acute illness (food-poisoning), paratyphoid B causes a disease with no clear clinical distinctions from enteric fever."⁴

With a view to studying Castellani's absorption reaction Bainbridge took the paratyphoid bacilli as a suitable group upon which to work. By the aid of this reaction he has now made it clear that the bacillus paratyphoid B

¹ At the time, these authorities believed the organism to be the cause of hog-cholera and their opinion was accepted by other observers subsequently. Hence the name by which it is still very commonly known, the bacillus of hog-cholera, *bacillus suispestifer*, or *bacillus cholera suis*. In 1903 however the researches of de Schweintz, Dorset and others showed that hog-cholera is not to be ascribed to the Salmon-Smith bacillus but to a filter-passing organism (Chap. LXIV.), the hog-cholera bacillus being merely a secondary infection.

² This bacillus will in future be described as "the aertrycke bacillus."

³ In future referred to as "the gaertner bacillus."

⁴ See however Paratyphoid B as a cause of food-poisoning p. 432.

is separate and distinct from the aertrycke bacillus, and this observation has been confirmed by Dean from a study of complement fixation reactions.

Bainbridge has further shown that unless the absorption tests be applied the paratyphoid B bacillus cannot be differentiated from the aertrycke bacillus, and that in practically all cases the so-called paratyphoid B bacillus isolated from cases of food-poisoning is in reality the aertrycke bacillus. The paratyphoid B bacillus can however give rise to acute gastro-enteritis though this would at present seem to be a very uncommon association (p. 432).

Bainbridge's investigations have also demonstrated that a number of the bacteria causing diseases in the lower animals (*vide post*) are not separate species, but are either identical with the paratyphoid B bacillus, the aertrycke bacillus or the gaertner bacillus, or are impure cultures of two or more of these organisms. The various rat and mice viruses are therefore shown by laboratory procedures, as well as by practical experience, not to be so harmless to man and the domestic animals as they are claimed to be.

Lignières proposed to designate all those organisms which had the morphological and cultural attributes of the bacillus of hog-cholera [*bacillus aertrycke*] by the name *Salmonella* after Salmon to whom the discovery of that organism is due. This term has met with some acceptance on the Continent, and is a convenient appellation under which to include a number of organisms very closely related bacteriologically, though clinically the diseases to which they give rise generally differ. It forms an appropriate classification for purposes of practical bacteriology and will therefore be adopted here. The *Salmonella* group, used in its original sense as defined above, includes the following organisms: the *bacillus paratyphosus B*, *bacillus enteritidis Aertrycke* (syn. *bacillus suipestifer*), and *bacillus enteritidis Gaertner*: as well as a number of organisms which have received specific names but which have now been shown to be identical with one or other of the preceding: these are *bacillus danysz*, *bacillus typhi murium*, *bacillus psittacosis* and *bacillus icteroides*.

Other names also have been proposed for the group of organisms discussed in this chapter: Theobald Smith suggested "the hog-cholera group"; Durham, the "intermediate group," and Trautmann, the "paratyphoid group."

The paratyphoid A bacillus is obviously excluded on cultural grounds from the *Salmonella* group. The "paratyphoid bacilli" will therefore be dealt with under two headings (1) The *bacillus paratyphosus A* (2) The *Salmonella* group.

The paratyphoid bacilli may then be grouped thus—

| GROUP. | SPECIFIC ORGANISMS. | SYNONYMS. |
|---|---|---|
| I. | <i>Bacillus paratyphosus A.</i> | |
| II. | The <i>Salmonella</i> group:— | |
| | (i) <i>Bacillus paratyphosus B.</i> | } <i>Bacillus</i> of hog cholera. } <i>B. suipestifer.</i> } <i>B. cholerae suis.</i> |
| | (ii) <i>Bacillus enteritidis Aertrycke.</i> | |
| | (iii) <i>Bacillus enteritidis Gaertner.</i> | |
| The organisms known as <i>Bacillus danysz</i> , <i>B. typhi murium</i> , <i>B. psittacosis</i> and <i>B. icteroides</i> are either identical with one or other of the members of the <i>Salmonella</i> group or are mixed cultures of two or more of these organisms. | | |

CHAPTER XXVI.¹

BACILLUS PARATYPHOSUS A.

Introduction.

Section I.—Experimental inoculation, p. 424.

Section II.—Morphology, p. 424.

1. Microscopical appearance and staining reactions, p. 424. 2. Cultural characteristics, p. 424.

Section III.—Biological properties, p. 424.

1. Biochemical reactions, p. 424. 2. Virulence, p. 425. 3. Toxin, p. 425. 4. Vaccination, p. 425. 5. Agglutination, p. 426. 6. Absorption tests, p. 427. 7. Complement fixation, p. 428.

Section IV.—The diagnosis of paratyphoid A infections. The isolation and identification of the bacillus, p. 428.

The pseudo-paratyphoid A bacillus, p. 430.

THE paratyphoid A bacillus was first described by Schottmüller who isolated it from the blood of patients suffering from a disease clinically indistinguishable from enteric fever.

Paratyphoid A fever is a septicæmia characterized by "a mild pyrexia simulating enteric fever, marked by no acute gastric or intestinal symptoms and rarely fatal" (Firth). The lymphatic system is less affected than in enteric fever though one case is recorded where a single perforation was found (Grattan and Wood).

The bacillus has never been isolated in England (Bainbridge)² and comparatively few cases of paratyphoid A infection have been recorded on the Continent of Europe. In America its distribution is uncertain: but it is worth noting that in one year in the Allegheny General Hospital the relation of paratyphoid A fever (48 cases) to enteric fever was 8 to 11 (Proescher and Roddy).

In India, on the other hand, paratyphoid A fever is very prevalent. Grattan and Wood estimate that one-third of the cases of "simple continued fever" in India are cases of paratyphoid A fever, and so constantly is the A variety of the bacillus found that paratyphoid fever in that country connotes an infection with the paratyphoid A bacillus (Firth).

The bacillus apparently remains in the system for a time after an attack of paratyphoid A fever and "carriers" would appear to be the chief agent in the dissemination of the disease (Firth). Convalescents are usually infective for a comparatively short period, and "chronic carriers" (persons in whom the bacillus remains more than 3 months), would seem to be uncommon.

¹ This chapter has been rewritten.

² Bainbridge, F. A., The Milroy Lectures, Royal College of Physicians, *Lancet*, 1912, i.

The paratyphoid A bacillus has been recovered from the gall bladder after death and during operations for gall stones or cholecystitis; it has also been isolated once from an abdominal abscess and once from an apparently healthy man. Bainbridge states that it has been isolated from a case of acute enteritis. The organism has never yet been recovered from other than human tissues.

SECTION I.—EXPERIMENTAL INOCULATION.

All strains of the paratyphoid A bacillus are virulent for laboratory animals. The inoculation of 4 c.c. of a broth culture sub-cutaneously is fatal to guinea-pigs (Brion and Kayser): in mice, inoculation produces a fatal disease accompanied with symptoms of acute enteritis.

Guinea-pigs and mice are easily infected with a fatal disease by feeding them on cultures of the bacillus.

SECTION II.—MORPHOLOGY.

1. Microscopical appearance.

The paratyphoid A bacillus is a short stout rod-shaped organism with rounded ends often having the appearance of a cocco-bacillus: in old cultures long filamentous forms are occasionally seen. It is very motile and is provided with from four to ten delicate flagella. Morphologically it is indistinguishable from the other bacilli of the typhoid-colon group.

Staining reactions.—The paratyphoid A bacillus stains readily with the ordinary basic aniline dyes and occasionally exhibits polar staining. The bacillus is decolourized by Gram's method.

2. Cultural characteristics.

The paratyphoid A bacillus is a facultative aërobe and grows readily on the ordinary media in a manner very like the typhoid bacillus.

Broth.—The medium is rendered cloudy and has a watered silk appearance.

Gelatin.—The colonies are iceberg-like, translucent and bluish: in stroke culture the growth is thin and streaked with blue. The medium is not liquefied.

Potato.—On potato the bacillus gives a barely visible glaze.

Artichoke.—Generally colourless: a green colour may be produced after some time.

Milk.—Milk is not coagulated.

Litmus milk.—In litmus milk, acid is formed, the colour of the litmus being changed to pink (p. 373): the acidity is permanent. No clot is formed. *The permanent acidity without clot is peculiar to this member of the typhoid-colon group.*

Litmus whey.—A slight but permanent acidity indicated by the change in colour of the litmus from amethyst to pink.

SECTION III.—BIOLOGICAL PROPERTIES.

1. Biochemical reactions.

(a) **Fermentation of carbohydrates.**—The paratyphoid A bacillus produces acid and gas in glucose but has no action (producing neither acid nor gas) on lactose. The bacillus is thus easily differentiated from the typhoid bacillus on the one hand and from the colon bacillus on the other.

It forms acid and gas also in lævulose, maltose,¹ galactose, mannite, dulcitate, sorbite and glycerih : but neither acid nor gas in raffinose, saccharose and lactose.

The paratyphoid A bacillus does not ferment carbohydrates so powerfully as the paratyphoid B bacillus.

(β) **Neutral-red media.**—The paratyphoid A bacillus like the colon bacillus reduces neutral-red, and in media containing the dye may give rise to a greenish fluorescence, but the reaction is less marked than with the colon bacillus and the Salmonella group. Fluorescence in neutral-red media is however a very inconstant change ; the best medium for the reaction is agar containing 1 per cent. of glucose and 1 c.c. per litre of a saturated aqueous solution of neutral-red.

(γ) **Endo's medium.**—On fuchsin-agar decolourized with sodium sulphite the bacillus, like the typhoid bacillus, gives colourless colonies.

(δ) **Caffeine media.**—According to Ducamp the paratyphoid A bacillus will not grow in broth containing 0.5 per cent. of caffeine (*vide B. paratyphosus B*).

(ε) **Malachite green media.**—Malachite green is decolourized by the paratyphoid A bacillus (1 week) but more slowly than by the bacilli of the Salmonella group (48 hours).

(ζ) **Vaccinated media.**—The paratyphoid A bacillus does not grow on media which have already served for the growth of the typhoid, colon, paratyphoid A or paratyphoid B bacilli.

(η) **Indol.**—The paratyphoid A bacillus forms no indol in culture.

2. Virulence.

Sacquépée and Chevrel were able to increase the virulence of the bacillus by passing it through a series of animals by sub-cutaneous inoculation. The inoculation of 0.5 c.c. of a twenty-four-hour culture of the exalted virus in broth was sufficient to kill guinea-pigs.

The virulence is lost somewhat readily in culture.

3. Toxin.

The paratyphoid A bacillus produces a soluble toxin in culture media. Cultures sterilized at 60° C. are pyogenic when inoculated beneath the skin of guinea-pigs. Cultures of an exalted virus sterilized by heat or filtered through porcelain kill guinea-pigs when inoculated sub-cutaneously in doses of 3-10 c.c.

4. Vaccination.

Guinea-pigs and white rats can be easily vaccinated against the paratyphoid A bacillus by inoculating them with attenuated or sterilized cultures. From the experiments of Cushing and of Sacquépée and Chevrel it would appear that animals immunized against the paratyphoid A bacillus are also immunized but to a lesser degree against the typhoid bacillus (intervaccination or group immunization). The serum of immunized animals is distinctly immunizing and bacteriolytic for paratyphoid A.

Human vaccination.—In man, vaccination with Wright's typhoid vaccine affords no immunity against an infection with the paratyphoid A bacillus.

Prophylactic vaccination of the human subject though suggested (Bainbridge, Leishman) has not yet been attempted. Certain preliminary laboratory experiments have however been quite recently recorded by Cummins and Cumming.

¹ The amount of gas formed out of maltose is always small whatever the organism.

5. Agglutination.

The serum of vaccinated animals and of persons suffering from paratyphoid A fever will agglutinate the paratyphoid A bacillus. The serum-diagnosis of paratyphoid A fever however requires considerable skill and care on the part of the observer.

Agglutination with the serum of immunized animals.—The serum of animals highly immunized against the paratyphoid A bacillus contains both specific agglutinins and group agglutinins. Not only does such a serum agglutinate the paratyphoid A bacillus but it agglutinates also the typhoid bacillus and other related bacilli; but if the limits of agglutination be determined it will be found that the serum agglutinates the paratyphoid A bacillus in a much higher dilution than it agglutinates the typhoid or any other related bacillus.

Thus an anti-paratyphoid A serum agglutinates all strains of the paratyphoid A bacillus in dilutions of 1-1,000, 1-5,000 and even 1-40,000. On the other hand it has very little agglutinating action on strains of the paratyphoid B bacillus, on the gaertner bacillus, or on the aertrycke bacillus and only agglutinates the typhoid bacillus in dilutions of 1-200, 1-100 or 1-20.

The following table¹ illustrates this:—

Agglutination limits after incubation for 2 hours at 42° C. Macroscopic method. In all cases control tubes showed no agglutination.

| SERUM. | EMULSION OF BACILLI. | | | |
|----------------|----------------------|----------------|------------|-----------|
| | Paratyphoid A. | Paratyphoid B. | Aertrycke. | Gaertner. |
| Paratyphoid A. | 50,000 | < 100 | < 100 | < 100 |

Conversely, experimental typhoid serums have little action on strains of the paratyphoid A bacillus and only agglutinate them in low dilution.

A similar statement is justifiable for paratyphoid B, aertrycke and gaertner serums.

To sum up: *By means of the agglutination reaction with an experimental serum the paratyphoid A bacillus can with certainty be identified, being clearly differentiated from the typhoid, paratyphoid B, gaertner and aertrycke bacilli.*

Agglutination reaction with human serum.—The conditions are somewhat different when working with an human serum.

The experience in cases of paratyphoid fever in India is as follows:—The agglutination titre is usually low (1-20 to 1-40) and the reaction commonly transient: it may be quite as high for the typhoid bacillus as during an ordinary attack of enteric fever and the co-agglutinin for this bacillus may remain after the specific agglutinin has vanished. Rarely, the specific agglutinin alone is present; and sometimes both it and the co-agglutinin for the typhoid bacillus are present in so small an amount and for so short a time as to be easily overlooked. Finally it is possible in undoubted cases of paratyphoid A fever for the serum to contain co-agglutinins for the typhoid and paratyphoid B bacilli but no specific agglutinin (Firth).²

The group agglutinin for the typhoid bacillus quickly disappears in para-

¹Bainbridge, F. A., *Journal of Pathology and Bacteriology*, xiii. p. 341.

²*Journal of the Royal Army Medical Corps.*

typhoid A fever, in contrast to the persistence of the specific agglutinin which follows enteric fever (Firth).

Moreover, Grattan and Wood¹ record that "In some cases the limits of co-agglutination for the typhoid bacillus exceeded the limits of specific agglutination; and that in other cases again, at one period of the disease the limits of co-agglutination for the typhoid bacillus exceeded the limits of specific agglutination, and at another period the limits of specific agglutination exceeded the limits of co-agglutination."

These observers find that "antityphoid inoculation seldom if ever produces co-agglutinins for the paratyphoid A bacillus. Hence in a typhoid-vaccinated individual a serum reaction against the paratyphoid A bacillus in a dilution of 1-20 is strong evidence of paratyphoid A fever. "And in inoculated persons an attack of paratyphoid A fever raises the titre of agglutination for the typhoid bacillus about the 8th day, while the agglutinins for the paratyphoid A bacillus do not appear much before the 12th day."

6. Absorption tests.

To explain the phenomena just described it is necessary to assume the presence of group agglutinins, or, in those cases where co-agglutination is very marked, the existence of a double infection.

Castellani's method of absorption of agglutinins may be used for diagnostic purposes when the results of the agglutination tests are doubtful.

Let us take the case of a serum which has but little agglutinating action on the typhoid bacillus but agglutinates the paratyphoid A bacilli in higher dilution (1-40 to 1-100). To such a serum add paratyphoid A bacilli in sufficient quantity to remove the whole of the paratyphoid A agglutinins and centrifuge. Then test the agglutinating action of the clear supernatant fluid on both the typhoid and paratyphoid A bacilli (to ascertain that the agglutinins for the paratyphoid A bacillus have been removed). If the typhoid bacillus be agglutinated it may be assumed that agglutinins were present in the serum for both the typhoid and paratyphoid A bacilli; but if on the other hand the typhoid bacillus is not agglutinated, then the original action of the serum on the typhoid bacillus was due to the presence in it of a co-agglutinin. But in cases of paratyphoid A fever, when the serum agglutinates both the typhoid and paratyphoid A bacilli, absorption with the paratyphoid A bacillus removes all agglutinins—both specific and group; while absorption with the typhoid bacillus removes merely the co-agglutinin for the typhoid bacillus, leaving the specific agglutinin for the paratyphoid A bacillus intact even though it may in the first instance have only been demonstrable in a dilution of 1-20 (Harvey and Wood).

If a person inoculated against enteric fever and whose serum agglutinates the typhoid bacillus become infected with a paratyphoid A infection, absorption of the serum with the paratyphoid A bacillus only reduces the titre and does not entirely remove the agglutinins specific for the typhoid bacillus (Harvey and Wood).

If in a case of paratyphoid A fever the serum agglutinates the typhoid bacillus but not the paratyphoid A bacillus, absorption with the latter will remove the whole of the agglutinin (co-agglutinin) for the former, whereas the agglutinins for the typhoid bacillus in cases of enteric fever are not removed by absorption with the paratyphoid A bacillus (Harvey and Wood).

Another difference between the specific and group agglutinins for the paratyphoid A bacillus is that when the serum-emulsion mixture is put up in sedimentation tubes the specific agglutination appears almost immediately while the co-agglutination does not appear for some hours (Harvey and Wood).

To sum up: *The serum of persons suffering from paratyphoid A fever usually*

¹ *Journal of the Royal Army Medical Corps.*

agglutinates the paratyphoid A bacillus only in low dilution (1-20 to 1-40). Co-agglutinins for related organisms and especially for the typhoid bacillus are as a rule also present in the serum: the amount of the co-agglutinin is very variable often exceeding the titre of the specific agglutinin, and moreover may be present to the exclusion of the latter. Absorption tests will allow of a correct diagnosis.

7. Complement fixation.

The serum of animals immunized with the paratyphoid A bacillus contains an immune body which is fixed by both the paratyphoid A and typhoid bacilli, but the converse does not hold good; the immune body in the serum of animals immunized with the typhoid bacillus is not fixed by the paratyphoid A bacillus (Rieux and Sacquépée).

In healthy men inoculated against enteric fever, specific amboceptors for the paratyphoid A bacillus were present in amounts apparently equal to the specific amboceptors for the typhoid bacillus, though in no case had the individuals tested suffered from paratyphoid A fever (Grattan and Wood).

If the dosage of antigen and antibody be carefully determined, the paratyphoid A bacillus can be clearly and absolutely differentiated from the typhoid and paratyphoid B bacilli by the complement fixation method (H. R. Dean).

Dean's method. Preparation of extract.—Agar cultures were sown in Roux bottles, incubated at 37° C. for 48 hours and then emulsified in 20 c.c. of distilled water. The emulsion was tubed in quantities of 5 c.c., and in some cases heated to 60° C. (this heating had no effect on the properties of the extract); then after being thoroughly shaken it was frozen hard, and subsequently thawed slowly at room temperature. After freezing and thawing twice the emulsion was shaken all night in a shaking machine, again frozen and thawed twice, shaken again all night and then centrifuged until the supernatant liquid was clear or only slightly opalescent. The extract was then stored in the cold room.

Antiserum.—Rabbits were inoculated intra-venously four or five times at intervals of 4 or 5 days with saline emulsions of 24-hour agar cultures. The animals were tested on the eighth day after the last inoculation and if the serum was satisfactory were bled on the ninth or tenth day. The serum was heated at 56° C. for half an hour and stored in quantities of 2 c.c.

Complement.—The guinea-pig serum was prepared on the day of use.

Hæmolytic system.—Sheep red cells and rabbit-sheep serum.

Experimental data.—The bulk of fluid in each tube was 2·5 c.c.—0·5 c.c. of diluted bacterial extract (antigen), 0·5 c.c. of diluted serum (antibody) and 0·5 c.c. of a 1 in 10 dilution of fresh guinea-pig serum (complement). After incubation there were added 0·5 c.c. of the dilution of hæmolytic serum (determined on the day of the experiment) and 0·5 c.c. of a 1 in 20 suspension of washed sheep cells.

The dilution of antiserum necessary for a differentiation experiment can be ascertained by the titration of the antiserum with the homologous extract. As a rule satisfactory differentiation can be obtained with the greatest dilution of antiserum which is found to give a thoroughly satisfactory reaction with the homologous extract.

With low dilutions of antiserum a marked group reaction is obtained and differentiation is impossible. The group antibodies can however be removed by absorption (*vide supra*).

SECTION IV.—THE DIAGNOSIS OF PARATYPHOID A. INFECTIONS.

The isolation and identification of the bacillus.

The diagnosis of a paratyphoid A infection should be based upon the demonstration of the specific organism in the tissues or excreta.

Any of the methods described for the isolation of the typhoid bacillus are quite applicable to the isolation of the paratyphoid A bacillus.

Agglutination reactions with the patients' serum supplemented by absorption tests should form a part of the diagnosis in every case.

1. The most important step is to demonstrate the presence of the bacillus in the blood stream. (The isolation of the paratyphoid A bacillus is comparatively easy during the first 4 or 5 days of the pyrexia: the chances of a successful blood culture are greatly diminished by the 8th day, even when the usual 5 c.c. of blood is withdrawn—cf. enteric fever (Grattan and Wood).)

Grattan and Wood sow the blood (5 c.c.) on sterilized ox bile and after incubating for 24 hours at 37° C. plate the growth on Conradi-Drigalski's original medium, which they consider better than the more recent selective media¹; they incubate again and then pick off colonies which resemble those of the typhoid bacillus, which is indistinguishable on the Conradi-Drigalski medium from the paratyphoid A bacillus.

The organism isolated must be fully identified. Firstly, it must be shown to belong to the paratyphoid group by a careful study of its morphological, staining, cultural and fermentation reactions. (The characteristics of the paratyphoid A bacillus may be conveniently summarized here: it is a short stumpy gram-negative bacillus which does not liquefy gelatin, forms no indol, does not clot milk but turns the medium permanently acid, ferments glucose, mannite and dulcitate with production of acid and gas, but has no action on lactose and cane sugar.) Then the bacillus must be examined, as regards its agglutination reactions, with known typhoid, paratyphoid A and paratyphoid B serums.

In the case of an organism isolated from the blood these tests are sufficient for identification (Grattan and Wood).

2. To isolate the organism from the urine or from the excreta some of the material should be sown in dulcitate broth or dulcitate peptone water. Dulcitate is the enrichment medium *par excellence* for the paratyphoid group (Boycott). After incubation—2 or 3 days sometimes elapse before the paratyphoid A bacillus produces gas in dulcitate media, but ultimately the amount formed is considerable—some of the culture may be plated on Conradi-Drigalski's or M'Conkey's medium and the organisms isolated tested as above. But according to Grattan and Wood when a bacillus resembling the paratyphoid A bacillus is isolated from the stools it is necessary to carry the identification a step further (by means of absorption tests) than in the case of a similar organism isolated from the blood.

A 24-hour growth of the suspected organism on agar is emulsified in about 0.2 c.c. of paratyphoid A serum—which is diluted according to its titre, the object being to have an excess of bacilli for the amount of agglutinin present: e.g. a serum having a titre of 1-300 may be diluted ten times.

Incubate the emulsion for 2 hours at 37° C., centrifuge and put up the clear supernatant liquid in a series of dilutions in sedimentation tubes and test its agglutinating action with a known paratyphoid A bacillus.

If the organism used for absorption be the paratyphoid A bacillus then it will have completely removed the specific paratyphoid A agglutinins from

¹ None of these media will differentiate with any degree of certainty the typhoid bacillus from the paratyphoid bacilli. That however is immaterial since it is unlikely that they will be present together. The main use of these media is to differentiate at sight the typhoid and paratyphoid bacilli from the colon bacillus which is invariably present and usually in large numbers.

the serum. Grattan and Wood say :—" before accepting a suspected organism we require that it shall completely remove the agglutinin specific for the paratyphoid A bacillus. As controls we have frequently tested heterologous organisms such as the typhoid, paratyphoid B and colon bacilli against our paratyphoid A serum but have never removed the agglutinin specific for the paratyphoid A bacillus."

3. The reactions of the serum of patients suffering from paratyphoid A fever have been described above.

The pseudo-paratyphoid A bacillus.

This organism appears to be a common inhabitant of the intestines of pigs (Morgan) and has once been isolated from the human subject during some investigations on the cause of summer diarrhoea (Morgan).

The pseudo-paratyphoid A bacillus is culturally identical with the paratyphoid A bacillus but differs from the latter in that it is not agglutinated by a specific paratyphoid A serum.

CHAPTER XXVII.¹

THE SALMONELLA GROUP.

1. *Bacillus paratyphosus* B.

Introduction.

Section I.—Experimental inoculation, p. 433.

Section II.—Morphology, p. 433.

Section III.—Biological properties, p. 434.

Section IV.—The isolation and identification of the bacillus, p. 437.

2. *Bacillus enteritidis* Aertrycke.

Introduction, p. 438.

Section I.—Experimental infection, p. 439.

Section II.—Morphology, p. 440.

Section III.—Biological properties, p. 440.

Section IV.—Isolation and identification of the bacillus, p. 441.

3. *Bacillus enteritidis* Gaertner.

Introduction, p. 442.

Section I.—Experimental inoculation, p. 442.

Section II.—Morphology, p. 443.

Section III.—Biological properties, p. 443.

Section IV.—Isolation and identification of the bacillus, p. 444.

4. *Pseudo-gaertner* bacilli, p. 444.

5. *Bacillus typhi murium*, p. 444.

6. Danyss's virus, p. 444.

7. The bacillus of psittacosis, p. 445.

8. *Bacillus icteroidea*, p. 445.

1. *BACILLUS PARATYPHOSUS* B.

LIKE the paratyphoid A bacillus the paratyphoid B bacillus was first isolated by Schottmüller in 1900-1 from cases of disease in man clinically indistinguishable from enteric fever.

In England the description "paratyphoid B bacillus" is limited to those strains which in their cultural, agglutination and absorption characteristics are identical with the strain originally isolated by Schottmüller (p. 420).

The relationship of this bacillus to the other organisms of the Salmonella group has already been discussed (p. 422) and the position may be summarized by stating that in England the following species—all identical culturally—are distinguished, viz. :—

1. *Bacillus paratyphosus* B. (Schottmüller).

¹ This chapter has been rewritten.

2. *Bacillus enteritidis* Aërtrycke (Durham, De Nobele) vel *B. suispestifer*, vel *B. cholerae suis* (Salmon) vel bacillus of hog cholera.

3. *Bacillus enteritidis* Gaertner.

This classification is unfortunately not adopted on the Continent. German observers, as Bainbridge points out, regard the paratyphoid B bacillus (Schottmüller) and the aërtrycke bacillus as identical species, the value of absorption tests not having yet been acknowledged, and hence considerable confusion results from reading their observations. The two names are retained in German publications but merely as labels to indicate the source of the strain: if obtained from a human source it is designated the paratyphoid B bacillus, if from animals, the hog cholera bacillus. Consequently what in English nomenclature is a paratyphoid B. bacillus may in German be an aërtrycke bacillus, and conversely. In France the recent important work of Bainbridge and O'Brien has not yet appeared in print.

In Europe the paratyphoid B bacillus has been isolated from and accepted to be the cause of two very different clinical types of disease, one indistinguishable by its symptoms from enteric fever, the other characterized by the symptoms of what is generally known as "food-poisoning." Whichever type the symptoms assume, the disease is a septicæmic condition, and the organism can be recovered from the blood during life and from the spleen after death.

The former is by far the more common of the two types of infection, and in Europe and America a very large number of cases of paratyphoid fever due to the paratyphoid B bacillus have been recorded. In England it is estimated that about 3-6 per cent. of all cases of enteric fever are due to infection with the paratyphoid B bacillus, in America about 10 per cent. and in Germany also about 10 per cent. (Boycott). In South Africa paratyphoid B fever appears to be a common disease (M'Naught).

Thus in these countries paratyphoid fever is a paratyphoid B infection; but in India the disease seems almost without exception to be caused by the paratyphoid A bacillus (p. 423).

As regards symptoms of food-poisoning due to paratyphoid B the present information is scanty and unreliable. In only one instance at present has the paratyphoid B bacillus been *proved* to be present in cases of acute gastro-enteritis and that instance is the outbreak recorded by Bainbridge and Dudfield.¹

The German accounts of food-poisoning due to the paratyphoid B bacillus cannot be accepted, because in Germany no distinction is drawn between the paratyphoid B. and aërtrycke bacilli; and the latter is shown by Bainbridge to be the common cause of food-poisoning (p. 438). (This observer finds that all the organisms isolated from clinical cases of food-poisoning in England and Germany which he has examined are strains of the aërtrycke bacillus.)

Distribution of the bacillus in the body.—The paratyphoid B bacillus is present in the blood-stream, in the internal organs and in the intestinal contents of infected persons. Apart from symptoms of paratyphoid fever and food-poisoning it has been found in the gall bladder in cases of disease of the gall bladder and in persons in apparently good health—"carriers." Carriers in connexion with paratyphoid B infections were first investigated by Lentz. Bainbridge abstracted the records available and found that in the majority of cases (26 out of 29) they were of the female sex, that a striking percentage (7 out of 26) had symptoms of biliary disorders, and that in every case their blood agglutinated the bacillus. Paratyphoid B carriers are therefore very like enteric carriers, and they may originate epidemics of paratyphoid B infection (Sacquépée and Bellott, Bainbridge and Dudfield).

Apart from cases of paratyphoid fever and persons who become "carriers," the bacillus is very rarely if ever found in the human intestine or urine (Bainbridge and O'Brien). No paratyphoid B bacilli were found by Morgan in summer diarrhoea, by Williams, Rundle and Murray in healthy children, by Seiffert, and by Sobernheim in healthy men, by Bainbridge and O'Brien in convalescents from enteric fever, or by Savage in enteric fever patients (caused by the typhoid bacillus) and healthy persons.

¹ *Journal of Hygiene*, xi. p. 24.

In Germany on the other hand "paratyphoid bacilli" *i.e.*—paratyphoid B and aertrycke—have been isolated from the blood, stools and urine of healthy persons (Conradi, Prigge and Sachs-Mücke, Gaethgens); they have been found in enteric fever patients, convalescents and contacts, and have been isolated also from persons suffering from other diseases (Conradi).

Distribution of the bacillus outside the body.—Bainbridge failed to detect the paratyphoid B. bacillus in the excreta of 50 healthy pigs. In Germany the organism is said to have been isolated from sausages (Hübener, Rommeler), milk, meat, etc. (p. 438). Bainbridge however has examined a number of these so-called paratyphoid B bacilli and finds that the strains submitted to him fall into two groups, *viz.* :

1. Bacilli of the aertrycke type which were all obtained from food or from cases of food-poisoning.

2. Bacilli of the paratyphoid B type which were all derived from cases of paratyphoid fever and paratyphoid carriers.

Bainbridge therefore is of opinion that the normal habitat of the paratyphoid B bacillus is the human alimentary canal and bile passages, and that its distribution is limited to those situations.

SECTION I.—EXPERIMENTAL INOCULATION.

The pathogenicity of strains of the paratyphoid B. bacillus is typically of a high order (Boycott). Using guinea-pigs weighing 250 grams and broth cultures incubated at 37° C. for 20 hours Boycott found that the inoculation of 1 c.c. beneath the skin led to death in 18–40 hours, and that 0.1 c.c. intra-peritoneally was followed by death in less than 18 hours.

Feeding experiments were negative (Boycott).

SECTION II.—MORPHOLOGY.

1. **Microscopical appearance. Staining reactions.**—The paratyphoid B bacillus is indistinguishable as regards its appearance under the microscope and in its staining reactions from the typhoid and paratyphoid A bacilli.

It is a stout, motile cocco-bacillus tending to stain more deeply at the ends than in the centre; in culture especially on gelatin it sometimes grows out into filamentous forms; it stains with ordinary aniline dyes and is gram-negative.

2. **Cultural characteristics.**—In its cultural characteristics the paratyphoid B bacillus approaches the colon bacillus.

In **broth** it grows abundantly, often forming a pellicle on the surface and occasionally giving rise to a faecal odour.

On **gelatin**, isolated colonies are transparent at first but fairly rapidly become opaque; occasionally they retain the "iceberg" appearance. In stroke culture the bacillus most frequently gives rise to a thick whitish layer which becomes opaque and viscous as the culture ages.

On **potato** the growth generally resembles that of the colon bacillus—a thick, brown viscous layer; a glazed appearance is uncommon.

On **artichoke** the culture is green in 2 or 3 days.

Milk.—Milk is not coagulated but becomes clear and about the second week acquires a brownish tint.

Litmus milk.—First of all the medium becomes slightly acid, the litmus turning red: but after about 3–7 days a secondary alkalinity develops, the colour of the litmus reverting to blue.

Litmus whey.—In the first few days a small amount of acid is formed turning the litmus red, afterwards the blue colour reappears.

Vaccinated media.—A normal growth takes place on media which have served for the growth of the typhoid and paratyphoid A bacilli. On the other hand on media which have served for the growth of the colon bacillus the culture is poor; and on media on which the paratyphoid B bacillus has been grown it is very inconstant.

Cultural differences between the paratyphoid A. bacillus and the paratyphoid B. bacillus.

| | PARATYPHOID A. | PARATYPHOID B. |
|----------------------|--|--|
| Cultures on gelatin. | Scanty and transparent (like typhoid). | Thick and opaque (like the colon bacillus). |
| Cultures in broth. | Cloudy; no pellicle. | Cloudy; pellicle very common. Often faecal odour. |
| Cultures on potato. | Faint glaze (like the typhoid bacillus). | Thick, pigmented growth (like the colon bacillus). |
| Milk. | No coagulation. | No coagulation, medium slowly cleared. |
| Litmus milk. | Permanently red. | Turned red first, then blue. |
| Litmus whey. | Permanently red. | First red, then blue. |

SECTION III.—BIOLOGICAL PROPERTIES.

1. Biochemical reactions.

(a) **Action on carbohydrates.**—The paratyphoid B. bacillus forms acid and gas when sown in glucose, mannite, dulcitol, lævulose, galactose, arabinose, maltose and sorbite, but gives rise to neither acid nor gas in lactose, saccharose, salicin, raffinose, and inulin.

(β) **Indol production.**—The paratyphoid B. bacillus produces no indol even when incubated in peptone water for 10 days.

(γ) **Neutral red media.**—Very often the colour of the medium is reduced but the change is not constant (*vide* paratyphoid A).

2. Toxins.

Cultures of paratyphoid B. contain soluble toxins. A dose of 5–9 c.c. of a filtrate of a culture on Martin's broth (2–8 days at 37° C.) is fatal to guinea-pigs when inoculated sub-cutaneously. Franchetti prepared a toxin which was fatal to rabbits in doses of 1 c.c. per kg. of body weight when inoculated intra-venously, by making an emulsion of cultures in sterile distilled water, shaking for 2 days, centrifuging and heating to 44° C. for 3 hours.

Cathcart grew the paratyphoid B. bacillus on agar in Roux bottles, washed off the growth with distilled water or normal saline solution, added a little toluol and after repeatedly shaking for 8–10 days and then heating to 60° C. for half an hour obtained an endotoxin which proved fatal to mice in doses of 0.1 c.c. intra-peritoneally in 24 hours. This toxin is thermostable at 100° C.

3. Vaccination. Properties of immune serums.

Animals can be easily immunized by inoculating them with heated or attenuated cultures (*vide infra*). Franchetti has prepared an agglutinating and antitoxic serum by inoculating rabbits with his toxin (*vide supra*).

Boycott found that vaccination with the paratyphoid B. bacillus was protective against the paratyphoid B. bacillus but not against the aertrycke bacillus.

4. Agglutination.

Agglutinins are developed in the blood in response to a naturally acquired infection in man and to the inoculation of the bacillus in animals.

Serum reactions in human paratyphoid B. fever.—It would appear that a careful determination of the ultimate limits of agglutination will, at any rate in the great majority of cases, give accurate information as to the nature of a typhoid or paratyphoid [B.] serum (Boycott).

As a rule a paratyphoid B. serum has little agglutinating action on the typhoid bacillus: thus in a case recorded by Sacquépée and Rieux a paratyphoid B serum agglutinated the paratyphoid B bacillus isolated from the patient in a dilution of 1-2000 and the typhoid bacillus in only 1-40.

But anomalous results are occasionally observed. Zupnik has shown that the serum from cases of enteric fever—determined by isolation of the typhoid bacillus—may agglutinate the paratyphoid B. bacillus in as high or even in an higher dilution than it agglutinates the homologous organism. Pratt found that the serum of a patient from whose blood he isolated the typhoid bacillus agglutinated the paratyphoid B. bacillus in a dilution of 1 in 200 and had no action on the typhoid bacillus in a dilution of 1 in 10.

Normal human serum may agglutinate the paratyphoid B. bacillus up to a dilution of 1 in 100. But in paratyphoid B. fever the serum reaction is usually manifested in relatively high dilutions—up to 1-1000; and extraordinarily active human serums have been encountered by Savage (1-70,000) and Zupnik (1-140,000). Boycott's three cases all agglutinated in a dilution of 1-5000, and in only one of 21 cases observed by Zupnik was the reaction less than 1-1000.

Paratyphoid B fever cannot be diagnosed on a demonstration that the serum of a person suffering from an illness resembling enteric fever fails to agglutinate the typhoid bacillus even in low dilutions. And still less is a diagnosis of paratyphoid fever justified by the bare fact that agglutination is observed with a paratyphoid B or similar bacillus (Boycott). Forty-one per cent. of typhoid serums (in a consecutive series of 86) agglutinated the paratyphoid B bacillus (Boycott).

In the paratyphoid B *food-poisoning* epidemic investigated by Bainbridge and Dudfield the serum of the persons involved agglutinated the paratyphoid B bacillus in dilutions of 1-100 to 1-400.

Animal serums.—The serum of animals inoculated with the paratyphoid B bacillus acquires the property of agglutinating the bacillus in high dilution. At the same time co-agglutinins are developed, especially for the aertrycke bacillus; indeed the amount of co-agglutinin for this organism may be so considerable as to be almost equal in amount to the specific agglutinin.

Bainbridge finds that if immunization be effected with living bacilli, instead of with sterilized cultures, the amount of co-agglutinin is much less and the titre of the specific agglutinin higher.

In the case of the paratyphoid B bacillus, which is relatively an highly

pathogenic organism, immunization is most successfully carried out by inoculating the animal thus

| | | |
|-----------|---|---|
| 1st day, | - | 0.001 c.c. of a 20-hour broth culture intra-venously |
| 15th day, | - | 0.01 c.c. " " " |
| 29th day, | - | 0.01 c.c. " " " |

and bleeding it on the 8th day after the last injection from the carotid after anaesthetization. In this way it is easy to obtain a serum with a specific titre of 1-20,000, and even of 1-40,000.

An anti-paratyphoid B serum has little action on the typhoid, paratyphoid A and gaertner bacilli, but agglutinates the aertrycke bacillus often in high dilution, hence the confusion which has until recently existed between that organism and the paratyphoid B bacillus. And the large amount of aertrycke co-agglutinin in a paratyphoid B serum, and paratyphoid B co-agglutinin in an aertrycke serum, is obviously the explanation of the "irregularity" of the action of a "paratyphoid B" serum on a "paratyphoid B" bacillus.

5. Absorption tests.

By means of absorption tests the true nature of a serum or of an unknown bacillus of the typhoid, colon, or paratyphoid groups is readily determined.

In the case of a paratyphoid B. serum the whole of the specific agglutinin as well as the co-agglutinins are removed by saturating with a paratyphoid B. bacillus: whereas by saturating with for example the aertrycke bacillus only the co-agglutinin for that organism is removed, leaving the specific agglutinin intact.

Similarly, in the case of an aertrycke serum all the specific agglutinin and the co-agglutinins are removed by saturating with an aertrycke bacillus, but by saturating with a paratyphoid B. bacillus only the co-agglutinin for the paratyphoid B. bacillus is removed.

It is due to these observations that the paratyphoid B. bacillus is distinguished from the aertrycke bacillus, and recognized to be an independent species.

Technique.

Assume that a paratyphoid B serum has an agglutination titre of 20,000.

1. Take 0.1 c.c. of the serum and add 4.9 c.c. of normal saline solution. This will give 5 c.c. of a 1 in 50 dilution of the serum. Divide into two equal portions of 2.5 c.c. each.

2. Take five large agar slope cultures (24 hours) of the paratyphoid B bacillus, scrape off the growth with a platinum wire and add it to one portion of the diluted serum. (The growth should not be washed off with the diluted serum.)

3. Emulsify similarly in the second portion of the diluted serum five large agar slope cultures of the aertrycke bacillus.

4. Incubate both emulsions at 37° C. for 2 hours.

5. Centrifuge the emulsions until the whole of the bacilli are precipitated and the supernatant fluids are clear.

6. Pipette off the supernatant fluids into separate sterile tubes.

7. Test the agglutinating reactions of both fluids up to a dilution of 1-20,000 against both the paratyphoid B bacillus and the aertrycke bacillus, remembering that the serum is already diluted 1 in 50.

Before absorption the serum agglutinated both the paratyphoid B. bacillus and the aertrycke bacillus in high dilution (1-20,000 and 1-10,000). After absorption with the paratyphoid B bacillus the titre for both organisms was reduced to about 1-100 to 1-400. After absorption with the aertrycke bacillus the titre for that organism had fallen to about 1-100 to 1-400 while the titre for the paratyphoid B bacillus was unchanged or only slightly reduced.

The amount of bacilli to be added must necessarily vary according to the titre; the higher the titre the more bacilli.

The following table taken from Bainbridge and O'Brien's paper will make the above statements clear.

| SERUM. | AGGLUTINATION LIMITS FOR | | |
|--|--------------------------|---------------|-------------------|
| | Bacillus F. | B. aertrycke. | B. Paratyphoid B. |
| 1. Bacillus F ¹ (original titre), - | 5,000 | 5,000 | 2,000 |
| Absorbed with bacillus F, - | <200 | <200 | <200 |
| " " B. aertrycke, - | <200 | <200 | <200 |
| " " B. paratyph. B, | 5,000 | 5,000 | <200 |
| 2. Bacillus aertrycke (original titre), - - - | 10,000 | 10,000 | 5,000 |
| Absorbed with bacillus paratyph. B - - - | 10,000 | 10,000 | <200 |
| Absorbed with B. F, - - - | <50 | <50 | <50 |
| 3. B. paratyphosus B (original titre), - - - | 5,000 | 10,000 | 20,000 |
| Absorbed with bacillus aertrycke, - - - | <400 | <400 | 10,000 |
| Absorbed with B. F, - - - | <400 | <400 | 10,000 |

6. Complement fixation.

By means of the complement fixation reaction H. R. Dean has shown that the paratyphoid B bacillus can be clearly differentiated from the typhoid and paratyphoid A bacilli and also from the aertrycke bacillus (p. 428 for technique).

Unless a suitable dilution of antiserum be employed the group antibodies in the serum will mask the specificity of the reaction. Dean has however shown that these group antibodies can be removed by absorption previously to carrying out the complement-fixation reaction. Thus, when a paratyphoid B antiserum is absorbed with an emulsion of paratyphoid A bacilli, the serum loses its capacity for binding complement in the presence of either a paratyphoid A extract or a typhoid extract. After absorption with a paratyphoid B emulsion the group antibodies are found to be removed, together with the antibodies specific for paratyphoid B.

SECTION IV.—ISOLATION AND IDENTIFICATION OF THE PARATYPHOID B. BACILLUS.

In cases of paratyphoid fever the organism may be isolated from the blood-stream, or from the stools or urine, and after death from the spleen.

In localized paratyphoid infections—*e.g.* cholecystitis, gall stones, abscesses in various parts of the body—material (bile, pus, etc.), from the site of infection must be used.

The material should be sown in dulcete (1–2 per cent.) broth or dulcete peptone water incubated at 37° C. for 24 hours or longer—in some cases the

¹ Bacillus F was an organism isolated by Williams, Rundle and Murray from cases of summer diarrhoea and shown by this test to be identical with B. aertrycke.

fermentation of dulcete is delayed—and then a loopful plated out on Conradi-Drigalski's or MacConkey's medium.

After incubating the plates for 24 hours a number of the colourless colonies are picked off and tested as regards their morphology, staining reactions, cultural characteristics (gelatin slopes and litmus milk) and biological properties (glucose, lactose).

If bacilli be isolated having up to this point all the characteristics of the paratyphoid B bacillus it is absolutely necessary, in order to definitely identify the organism, to test its reaction with a known serum both before and after absorption. If a specific serum be not available it will be necessary to inoculate a rabbit with minute doses of a living culture intra-venously (*vide supra*) and to test the action of this serum on a known paratyphoid B and a known aertrycke bacillus both before and after absorption.

2. *BACILLUS ENTERITIDIS AERTRYCKE.*

Synonyms: Bacillus of hog cholera: Bacillus suispestifer: B. cholerae suis.

The aertrycke bacillus was isolated in 1898 from epidemics of food-poisoning by Durham in England and De Nobele in Belgium and has become known as the aertrycke bacillus from the name of the village in which De Nobele's epidemic occurred.

A bacillus known as the hog-cholera bacillus or *bacillus suispestifer* had previously (in 1885) been isolated by Salmon and Theobald Smith from swine suffering from a disease known as swine fever or hog cholera (Ger. *Schweinepest*).

These two organisms are now admitted to be identical.

There is at present no uniformity in the nomenclature of the bacillus, some writers referring to it as the *Bacillus suispestifer* or bacillus of hog cholera, others as the aertrycke bacillus. *Bacillus suispestifer* is undoubtedly its original name but the term is misleading, as it implies a relationship which has been proved not to exist:¹ hence it has seemed better to adopt the title *Bacillus enteritidis Aertrycke* which represents the usual rôle of the organism in human pathology.

Occurrence in man.—The aertrycke bacillus appears to be the organism most frequently found in cases of "food poisoning" in man. "Food poisoning" is an acute septicæmic condition accompanied by vomiting, diarrhoea and collapse, and in severe cases terminating fatally.

In healthy human subjects the organism does not appear to be present.

Morgan isolated 2 strains of the bacillus from among 303 cases of summer diarrhoea, and Williams, Rundle, and Murray isolated a bacillus—Bacillus F—now admitted to be identical with the aertrycke bacillus (p. 437) from cases of the same disease.

In the lower animals the organism appears to have a wider distribution. Petrie and O'Brien found it frequently in healthy guinea-pigs, and O'Brien has described several guinea-pig carriers.

In Germany "paratyphoid" bacilli—probably the aertrycke bacillus (Bainbridge)—have been isolated from the intestines of healthy pigs (Uhlenhuth 8 per cent., Seifert 3.5 per cent.), from milk (Fischer), water (Conradi), and sausages (Hübener, Rommeler). Bainbridge and also Savage have failed to detect the presence of this organism in the intestines or meat of healthy animals in England.

¹ It should perhaps be pointed out here that in the opinion of Lourens and Glässer the view that hog cholera is due to a "filter-passer" is not borne out by their own observations. According to these experimenters hog cholera is due to Salmon's bacillus which can disintegrate into particles small enough under certain circumstances to pass through porcelain filters; that in all cases occurring during an epidemic the bacillus is found with the filter-passer; and it is certain that the bacillus alone can produce the disease. This view is contested by Uhlenhuth.

Bainbridge and O'Brien are of opinion that the normal habitat of the organism is the alimentary canal of pigs and perhaps of other domestic animals, and the meat derived from such animals, but that in England such occurrence is rare.

In many epidemics among pigs suffering from hog cholera the bacillus is present in small numbers in the blood and in enormous numbers in the intestinal lesions, in the juice of the lungs, in the bronchial mucus, urine, lymphatic glands, liver, spleen and excreta. It is not infrequently accompanied in these cases by other micro-organisms of secondary infection such as the colon bacillus. Swine become infected by eating food contaminated with the excreta of infected animals.

SECTION I.—EXPERIMENTAL INFECTION.

Guinea-pigs, rabbits, rats and mice are very susceptible to inoculation with the aertrycke bacillus.¹ These animals may be infected by inoculating them either beneath the skin, in the peritoneal cavity or in the muscles.

Guinea-pigs.—The bacillus is extremely pathogenic to guinea-pigs (Petrie and O'Brien). Doses of 0·001 c.c. of a young broth culture invariably caused the death of guinea-pigs weighing 250 grams in about 5 days: in some cases doses of 0·000,1 and 0·000,001 c.c. proved fatal. Guinea-pigs however are not readily killed by feeding them with cultures of the bacillus.

White rats.—Doses of 2 c.c. of a young broth culture were fatal in 6 days when given sub-cutaneously and 1 c.c. intra-peritoneally was fatal in 24 hours.

Mice.—Whether inoculated beneath the skin or into the peritoneal cavity a dose of 0·01 c.c. of a young broth culture is fatal within 2 days.

Rabbits.—0·1 c.c. of a young broth culture sub-cutaneously killed a rabbit weighing 900 grams in 2 days, 0·1 c.c. intra-peritoneally was fatal to a rabbit weighing 1300 grams in 24 hours, and 0·01 c.c. intra-venously killed a rabbit weighing 1300 grams in 5 days (Petrie and O'Brien).

Post mortem, the principal feature in acute cases is intense local hæmorrhagic œdema, and in more chronic cases necrosis or abscess at the site of inoculation: it is rare to find even minute spots in the liver and spleen in experimental animals (Petrie and O'Brien).²

Pigeons are less susceptible to infection; a fatal result can be obtained only by using considerable doses and inoculating into the muscles or beneath the skin. They cannot be infected by feeding.

The virulence of the bacillus can be increased in a very extraordinary manner by passing it through a series of pigeons. Selander, by passing a virulent strain which had already been passed through several rabbits through a series of pigeons, obtained a virus which was so highly virulent that 0·05 c.c. of the blood of the pigeon when inoculated into the ear vein of a normal rabbit killed the animal in 4 or 5 hours: the bacilli in the blood of this pigeon were thirty times more numerous than the red cells.

Swine.—Swine are only slightly susceptible to sub-cutaneous inoculation of cultures of standard virulence, and to overcome this insusceptibility a virus the virulence of which has been increased by passing it through pigeons must be used. Intra-venous inoculation is more severe and invariably

¹ A recently isolated strain must be used; in culture the organism soon loses its pathogenicity.

² These appearances may be compared with those found in two epizootics among guinea-pigs, which the same observers attributed to a filter-passing organism but from many of the animals affected with which the aertrycke bacillus was isolated. The intestines of these animals were often congested; the liver and spleen were usually congested, and occasionally contained small grey or yellow nodules: in some of the cases the supra-renals showed varying degrees of congestion, and patchy congested areas were often seen in the lungs: effusions into the serous cavities did not occur.

proves fatal: the symptoms are the same as, and *post mortem* the lesions are identical with, those found in the spontaneous disease. A like result follows if swine be fed with food which has been mixed with a large quantity—up to a litre—of a young culture of a recently isolated strain.

There are, however, essential differences between the disease produced by the inoculation of the aertrycke bacillus (*bacillus suispestifer*) and the spontaneous disease of hog cholera. In the latter the disease is transmissible from the sick to the healthy, the blood is infectious, and if the animal recover, it is permanently immune in a high degree: in the former all these characteristics are absent; the explanation being that the spontaneous disease is caused by a filtrable virus with which the bacillus aertrycke (*suispestifer*) is associated merely as a secondary infection.

Sheep, cows and calves can only be infected by intra-venous inoculation.

SECTION II.—MORPHOLOGY.

1. Microscopical appearance.—The bacillus aertrycke has the microscopical appearances and staining reactions common to the members of the typhoid-colon group. In tissues and infected fluids the bacillus is always non-motile, but in broth, agar or gelatin cultures it is highly motile and has four to seven flagella (Ferrier).

Metchnikoff has drawn attention to the marked pleomorphism of the aertrycke bacillus and has pointed out that in cultures long filaments as well as cocci sometimes arranged in chains are seen, in addition to the typical cocco-bacillary forms.

2. Cultural characteristics.—The cultural characteristics of the aertrycke bacillus are identical in every respect with the paratyphoid B bacillus and with the gaertner bacillus.

SECTION III.—BIOLOGICAL PROPERTIES.

1. Vitality and virulence.—The aertrycke bacillus retains its vitality and virulence in cultures for several months.

Cornil and Chantemesse obtained an attenuated bacillus by exposing a culture to a temperature of 43° C. for 90 days. The virulence of such an attenuated strain may be restored to normal by passing it through a series of rabbits; moreover the virulence of a normal strain may be raised to a very high degree by passage through a series of pigeons.

The bacillus is killed by heating it at 54° C. for 40 minutes (Selander). In brine it appears to be capable of living for a considerable length of time (Savage).

2. Biochemical reactions. (*a*) **Action on carbohydrates.**—The changes produced by the aertrycke bacillus when grown in media containing various carbohydrates are the same as those produced by the paratyphoid B and gaertner bacilli.

(*b*) **Indol.**—The aertrycke bacillus produces no indol in peptone water.

3. Vaccination.—Cornil and Chantemesse vaccinated rabbits by inoculating them with their attenuated cultures: Metchnikoff immunized rabbits by inoculating small doses of the virus.

The inoculation of swine with pure cultures of the bacillus produces no immunity (Dorset, MacClintock), or merely a transitory immunity (Lourens) against hog cholera.

4. Toxins. In the tissues of inoculated animals the aertrycke bacillus produces a very powerful toxin (Selander).

The blood of rabbits which have succumbed to inoculation of a virus of

increased virulence, after being heated at 57° C. for an hour to destroy any organisms present therein, is sufficiently virulent to cause the death of normal rabbits in 3-4 hours when inoculated in doses of 4-8 c.c.

The toxin appears to be produced in only minimal quantity in cultures. MacFadyen by triturating the bacilli in liquid air (p. 379) obtained a toxin which killed rabbits when inoculated intra-venously in doses of 1 c.c.

5. Agglutination.—The serum of persons suffering from “food-poisoning” due to the aertrycke bacillus agglutinates that bacillus but has little action on the gaertner bacillus.

The serum of animals immunized with the aertrycke bacillus agglutinates the homologous bacillus and contains co-agglutinins in considerable amount for the paratyphoid B bacillus, but has little or no action on the gaertner bacillus.

By means of the agglutination reaction with the serum of immunized animals the aertrycke bacillus is therefore at once distinguished from the gaertner bacillus, but by a simple determination of the limits of agglutination it is generally impossible to differentiate it from the paratyphoid B bacillus, both organisms being agglutinated by the respective specific serums in about the same titre (p. 435). To distinguish between the aertrycke and the paratyphoid B bacilli it is consequently necessary to adopt the method of absorption of agglutinins (p. 436) (Boycott, Bainbridge).

6. Absorption tests.—If the agglutination titre of an antiaertrycke serum be determined both for its own organism and also for the paratyphoid B bacillus the two determinations will in most cases be found to be approximately the same. On absorbing such a serum with its homologous bacillus all the homologous agglutinins as well as the heterologous co-agglutinins will be removed. But if absorbed with its heterologous bacillus the heterologous co-agglutinins will be almost entirely removed while the serum will still retain its power of agglutinating the homologous bacillus in high dilution; differentiation is thus rendered possible. The following table taken from Bainbridge (*Jr. Path. and Bact.* xiii. p. 453) will make these points clear.

| SERUM. | AGGLUTINATION LIMIT. | |
|--|----------------------|---------------|
| | B. paratyphoid B. | B. aertrycke. |
| B. aertrycke. Original titre :— | 10,000 | 10,000 |
| Absorbed with— B. aertrycke :— B. paratyphoid B :— | 100 <100 | 100 10,000 |

7. Complement fixation.—By using an homologous bacillary extract and a suitable dilution of an antiserum the aertrycke bacillus can be clearly differentiated from the paratyphoid B bacillus (Dean) (p. 437).

SECTION IV.—ISOLATION AND IDENTIFICATION OF THE AERTRYCKE BACILLUS.

In cases of food-poisoning the organism should be looked for in the suspected meat, in the blood of the patient and in the stools; and should a case prove fatal, in the spleen and intestinal contents.

The method will be the same as for the isolation of the paratyphoid B bacillus, viz.: preliminary enrichment in dulcete peptone water with subsequent plating on neutral-red-lactose agar or Conradi-Drigalski's medium. Suspicious colonies will then be examined as regards their biological properties—fermentation reactions and production of indol. The identification of the organism must finally rest upon a study of its reaction with known serums. The impossibility of distinguishing it from the paratyphoid B bacillus except by an investigation of absorption tests must be emphasized. If specific serums be not available the bacillus must be inoculated into a rabbit by the method described at p. 435, and the serum of the rabbit used for agglutination and absorption tests.

3. *BACILLUS ENTERITIDIS GAERTNER.*

The gaertner bacillus was isolated by Gaertner at Frankenhäusen in 1888 from some meat which was suspected to have been the cause of an epidemic of "food-poisoning" (p. 438) and also from the spleen of the patient who died as a result of the infection.

As a cause of "food-poisoning" the gaertner bacillus seems to be less common than the aertrycke bacillus, but epidemics attributed to it have been recorded by van Ermengem at Morseele, Brussels and Gand, by M'Weeney at Limerick and by other observers; while Bainbridge mentions eleven epidemics in which Gaertner's bacillus was identified. In most of the cases in which the origin of the incriminated food was traced, it was found to have been derived from animals which were ill at the time of slaughter.

Apart from epidemics of food poisoning the organism has rarely been recorded in man—four times by Morgan in cases of summer diarrhoea and once by Savage in a case of enteric fever.

The gaertner bacillus seems to cause an epizootic disease among animals. Such epizootics have been recorded in rats and rabbits (Boycott, Dunbar, Bainbridge) and in guinea-pigs (Bainbridge and O'Brien).

According to Uhlenhuth Gaertner's bacillus is a normal inhabitant of the rat's intestine.

In healthy cattle Gaertner's bacillus would appear to be of very uncommon occurrence; Sobernheim isolated it only twice from a very large number of such animals, and Savage, Müller and others have failed to detect it under similar conditions.

In sick cattle the organism has been isolated from calves suffering from diarrhoea, from cows in cases of *post partum sepsis*, and from young calves in which possibly infection took place through the umbilical cord.

Savage has recently recorded finding it in a sausage.

Boycott has described a spontaneous methæmoglobinæmia in rats due to infection with the gaertner bacillus.

The relation of the gaertner bacillus to other members of the paratyphoid group is considered in Chap. XXV.

SECTION I.—EXPERIMENTAL INOCULATION.

Recently isolated strains of Gaertner's bacillus are highly virulent to guinea-pigs, rabbits and mice on sub-cutaneous and especially on intra-peritoneal inoculation ($\frac{1}{2}$ to $\frac{1}{10}$ mg. of a moist culture). *Post mortem* examination shows hyperæmia of the lungs, spleen, supra-renal capsules, etc.: in many cases small areas of necrosis are seen in the liver.

To infect animals by feeding them with cultures of the bacillus large quantities of material have to be used: the young of a species are generally more susceptible to this mode of infection than adults of the same species.

Feeding experiments.—Mice fed on the muscles, spleen, liver, etc. of the

carcase of a guinea-pig killed with a dose of living virulent culture died in 8-15 days when the meat was given uncooked, and in 30-38 days when the meat was boiled before being given to them (Cathcart).

SECTION II.—MORPHOLOGY.

In its microscopical appearances and staining reactions the gaertner bacillus is indistinguishable from the other members of the typhoid-colon group.

On the ordinary media it grows readily yielding growths which are in no way different from those of the paratyphoid B bacillus and of the aertrycke bacillus.

SECTION III.—BIOLOGICAL PROPERTIES.

1. Biochemical reactions. (*a*) **Action on carbohydrates.**—The fermentation reactions of the gaertner bacillus are identical with those of the paratyphoid B and aertrycke bacilli.

(*β*) **Production of indol.**—Gaertner's bacillus produces no indol when grown in peptone water.

2. Toxin.—The gaertner bacillus contains a toxin of the endotoxin type (Cathcart). The most powerful toxin is obtained by washing off the bacilli from an agar culture in a Roux bottle with distilled water or normal saline solution, adding a little toluol, allowing to autolyze for 8-10 days—the bottles being repeatedly shaken during this process—and then sterilizing by heat (60°-100° C. for 30 minutes). Heated extracts are more toxic than unheated, and the toxin produced in this manner will withstand a temperature of 100° C. for 30 minutes.

Autolyzed bacilli heated for 30 minutes at 60° C. are fatal to guinea-pigs and mice in 24-48 hours when inoculated intra-peritoneally in doses of 0.1 c.c. The symptoms following the inoculation of toxin are very definite, the most notable being the glueing together of the eyelids and the prolonged (up to 9 hours) narcosis preceding death. *Post mortem*, there is hyperæmia of the lungs, spleen, supra-renals, etc., and frequently small necrotic areas in the liver.

3. Agglutination.—The serum of persons suffering from an infection with the gaertner bacillus, and the serum of animals immunized by repeated inoculation of small sub-lethal doses of the organism, have the property of agglutinating it.

In cases of human infection the limits of agglutination are about 1-250 to 1-1000. Human serums have no action, or, at most, a negligible effect, on the paratyphoid B and aertrycke bacilli.

The serum of immunized animals will agglutinate the gaertner bacillus when diluted as much as 50,000 times, but it has only a very slight action on the paratyphoid B and aertrycke bacilli: it is therefore a simple matter to distinguish paratyphoid B and aertrycke on the one hand from gaertner on the other. These facts may be illustrated by the subjoined table extracted from Bainbridge (*Jr. Path. and Bact.* xiii. p. 452).

| SERUM. | AGGLUTINATION LIMITS AFTER INCUBATING AT 42° C. FOR 2 HOURS. | | |
|-----------------------|--|---------------|--------------|
| | B. paratyphoid B. | B. aertrycke. | B. gaertner. |
| B. paratyphoid B, - - | 10,000 | 10,000 | < 100 |
| B. aertrycke, - - - | 20,000 | 20,000 | < 100 |
| B. gaertner, - - - | < 20 | < 20 | 50,000 |

SECTION IV.—ISOLATION AND IDENTIFICATION OF THE BACILLUS.

The distribution of the bacillus in the bodies of infected persons and animals is the same as in the case of the aertrycke bacillus.

In attempting the isolation of the gaertner bacillus from material suspected to contain it the same methods will be adopted as in the case of other members of the group. After preliminary enrichment in dulcitate peptone water the culture will be plated on Conradi-Drigalski's or MacConkey's medium and a number of colourless colonies picked off and tested as regards their fermentation reactions. If these reactions are in agreement with those of the gaertner bacillus the bacilli must be tested against a known gaertner serum. Absorption tests are unnecessary in this case because the agglutination reaction is quite definite.

4. PSEUDO-GAERTNER BACILLI.

This term has been adopted by Savage to describe certain organisms not uncommonly found in food and in the animal intestine and not infrequently present also in the human intestine.

These organisms resemble the Salmonella group of bacilli so closely as to be, culturally and biochemically, almost indistinguishable from them: they differ from them however in *not* being agglutinated by specific Salmonella serums. It follows from this that pseudo-paratyphoid B or pseudo-aertrycke bacilli would be an equally correct designation.

It would seem probable that Savage's pseudo-gaertner bacilli may be the same as the organisms referred to by German observers as paratyphoid C bacilli.

There remain for description three organisms discovered by various observers in fatal diseases in mice, rats and parrots respectively and known as *Bacillus typhi murium*, Danysz's virus and *Bacillus psittacosis*. They have now been shown to be identical either with the aertrycke, gaertner or paratyphoid B bacilli. The precise relationships of a fourth, *Bacillus icteroides*, have not yet been worked out.

5. BACILLUS TYPHI MURIUM.

Loeffler applied the above description to an organism which was the infecting agent in a fatal epizootic among the mice in his laboratory.

The organism is pathogenic to mice (*Mus musculus*) and field mice (*Mus arvicola*). Loser investigated a similar epizootic among *Mus agrarius*: Merechowsky and Issatchenko have also described similar epizootics, in one case affecting ground-squirrels, in the other white rats. Danysz recovered Loeffler's bacillus in an epizootic among *Mus arvicola*.

Trommsdorf, whose observations have been confirmed by Mayer and Bonhoff and by Shibayama, has shown that Loeffler's bacillus may infect man.

Bonhoff gave reasons for including Loeffler's bacillus with the gaertner bacillus and the aertrycke bacillus in the paratyphoid group.

Bainbridge has examined four strains of the *bacillus typhi murium* including one from Loeffler and finds that the name is applied to different organisms or to impure cultures of organisms, thus: two strains of the so-called *bacillus typhi murium* were cultures of the gaertner bacillus, a third was a mixture of the gaertner bacillus and the aertrycke bacillus and a fourth a mixture of the aertrycke bacillus and the paratyphoid B. bacillus.

6. DANYSZ'S VIRUS.

From a study of the cultural, agglutination and absorption reactions of a virus obtained from an epizootic among mice and known as "Danysz's virus," Bainbridge has shown that it is a pure culture of the *bacillus enteritidis Gaertner*.

Danzysz found that the grey rat is only moderately susceptible to infection, and that the organism loses its virulence after a few passages through rodents of this species. He has however succeeded in overcoming the immunity in the following manner:—the bacillus is first of all grown in sealed ampoules, then in collodion sacs in the peritoneal cavities of a series of rats, then passed through a mouse and finally through a series of rats (first young rats and subsequently older ones). Danysz by this means obtained a strain which is virulent for grey rats (*Mus decumanus*), black rats and winter rats (*Mus rattus*) and which has been placed on the market for the purpose of exterminating rats by means of the epizootic which it produces.

In view of the researches of Bainbridge which have shown not only that the *bacillus typhi murium* and Danysz's bacillus are pathogenic to man but also that other so-called rat viruses "harmless to man and domestic animals" are no other than pure cultures or mixtures of the Salmonella group, great care is required in handling these viruses. There can be no doubt but that human epidemics other than those recorded by Shibayama have resulted from insufficient care in dealing with such viruses.

7. THE BACILLUS OF PSITTACOSIS.¹

Psittacosis is an infectious disease of parrots and paroquets of which the causal agent is a bacillus first isolated by Nocard.

The organism is a member of the Salmonella group and is identical with the aertrycke bacillus (Bainbridge).

The bacillus is found in the bone marrow and in the blood of infected birds (Nocard). Gilbert and Fournier also isolated an organism similar to the bacillus of psittacosis from the intestines of healthy parrots.

It is said that the disease may be transmitted to man by contact with the feathers of an infected bird or with the cage in which an infected bird is confined.

Parrots and paroquets are readily infected by experimental methods. Subcutaneous and intra-muscular inoculation often fail, but intra-peritoneal, intravenous and intra-tracheal inoculation, and ingestion, set up an infection which proves fatal in a few days. Infected birds sit huddled up and motionless on their perches with their feathers ruffled and wings drooping. They suffer from diarrhoea, refuse their food and are in a constant state of drowsiness.

Mice, fowls and pigeons can also be infected. Rabbits and especially guinea-pigs are more immune.

The bacillus of psittacosis being identical with the aertrycke bacillus it follows that the same methods of isolation and identification are applicable to the former as to the latter.

8. BACILLUS ICTEROIDES.

This bacillus was isolated from cases of yellow fever and for a time was considered to be the cause of the disease, which is however now known to be due to a filter-passing organism. The *bacillus icteroides* is a member of the Salmonella group, and has been proved to be identical *culturally* with Salmon and Smith's hog cholera bacillus (*bacillus aertrycke*). No absorption tests however appear to have been carried out so that it is uncertain whether it is a paratyphoid B, an aertrycke or a gaertner bacillus.

¹ L. Psittacus and Gr. ψιττακός, parrot.

CHAPTER XXVIII.

THE PASTEURELLA GROUP OF BACILLI.

Introduction.

1. *Pasteurella gallinae*, p. 447.

Section I.—Experimental inoculation, p. 448.

Section II.—Morphology, p. 449.

Section III.—Biological properties, p. 451.

Section IV.—The isolation and identification of the bacillus, p. 452.

Similar organisms in epizootics among other birds, p. 452.

2. *Pasteurella cuniculi*, p. 453.

3. *Pasteurella suis*, p. 454.

4. *Pasteurella bovis*, p. 455.

5. *Pasteurella ovis*, p. 456.

6. *Pasteurella caprae*, p. 456.

7. *Pasteurella equi*, p. 456.

8. *Pasteurella canis*, p. 457.

M'Gowan's bacillus of distemper, p. 459.

9. Immunization with polyvalent vaccines, p. 459.

SINCE the discovery by Pasteur of the organism which is the cause of the disease known as fowl cholera, a similar organism has been isolated by many observers from epizootics affecting widely different species of animals.

The similarity between the organisms obtained from different animal species soon attracted attention. Hueppe classified in one group the epizootic diseases affecting fowls, pigs, rabbits, ferrets, cattle and wild animals, and described them as the "*hæmorrhagic septicæmias*." Nocard and Leclainche proceeding further in the generalization, affirmed that the causal organisms of all these diseases were merely varieties of one and the same organism to which they applied the term the "ovoid bacterium" (*la bactériole ovoïde*): but to perpetuate the discovery of the organism of fowl cholera by Pasteur, Toni and Trevisan appropriately suggested the use of the term *Pasteurella* in place of *bactériole ovoïde*. Lignières from a study of the organisms isolated from birds, pigs, cattle, etc., came to the conclusion that varieties of the *Pasteurella* could be distinguished by means of their pathogenic properties, and recent researches—especially those of Chamberland and Jouan—have justified this view. Consequently, as Nocard held, the organisms isolated from different animal species must be regarded as

varieties of the same bacillus, and the conclusion arrived at is in short this : that there is one Pasteurella, which can pass from one animal species to another, and which by adaptation in one species can produce a disease peculiar to that species.

Chamberland and Jouan showed that the avian pasteurella could naturally infect pigs and the swine pasteurella fowls.

By passage through rabbits in the laboratory the ovine pasteurella acquires the properties of the avian, and similarly, by passage through guinea-pigs, young chickens and fowls the swine pasteurella acquires the characteristics of the avian pasteurella.

Immunization with one variety establishes immunity against that as well as against the other varieties : thus, rabbits vaccinated with the swine pasteurella are at the same time immunized against the fowl pasteurella, and so on.

A description of the disease (*Pasteurellosis*) as it occurs in different animals will now be given, but it must be distinctly understood that this plan of dealing with the subject is adopted merely for convenience, and does not imply any doubt as to the truth of Nocard's view of the specific identity of the organisms found in the different species of animals.

Characteristics common to the pasteurella group.—Organisms of the pasteurella group are non-motile cocco-bacilli, gram-negative, very pleomorphic and staining more deeply at the ends than in the centre [*cf. B. pestis*]. They do not form spores, do not liquefy gelatin nor coagulate milk, they give no visible growth on potato, are primarily aërobic but can be grown anaërobically. They give rise in culture to a peculiar and characteristic odour.

According to Lignières these organisms do not produce indol in culture, but old cultures of the bacillus of fowl cholera (the avian pasteurella) certainly contain indol.

[The pasteurelloses and plague in animals.—Attention must be drawn to the close resemblance which exists between the bacilli of the pasteurella group on the one hand and the plague bacillus on the other, and also to the similarity of the lesions naturally produced by these organisms. Not only are these bacilli very much alike, indeed almost identical, in their morphological appearances and cultural characteristics, but the naked eye lesions produced in naturally infected animals are also very similar. Mistakes are therefore certain to be made unless in every case the causal organism is isolated and differential tests applied.

[Culturally the plague bacillus is most readily differentiated from bacilli of the pasteurella group by an observation of the growth in MacConkey's sodium taurocholate medium (p. 412) containing the following carbohydrates—glucose, lævulose, mannite and galactose. The plague bacillus grows in all these media, producing acid but no gas. The bacilli of the pasteurella group do not grow in MacConkey's medium (Indian Plague Commission).

[The formation of stalactites in broth culture is not a feature peculiar to the plague bacillus but is possessed also by, at any rate, many of the pasteurella bacilli.

[Animal inoculation will further assist the differential diagnosis (cf. Plague).]

1. PASTEURELLA GALLINÆ.

(The bacillus of fowl cholera.)

Pasteur was the first to describe the avian pasteurella, though it had previously been seen by Moritz, Perronçito, and by Toussaint.

Fowl cholera (fowl plague, fowl septicæmia, fowl typhoid) is an epizootic disease of the Gallinacæ (fowls, pheasants, guinea-fowl, turkeys and pigeons)

and Palmipedæ (ducks and geese). Rabbits though very susceptible to experimental infection are rarely attacked by the epizootic disease.

The course of the disease may be rapid and its onset sudden. Usually however it is not so acute, and the animals, after being miserable and drowsy and suffering from an attack of diarrhœa, often hæmorrhagic in character, die in 5-7 days. The sick birds do not feed, they droop their wings, their feathers are dull and bristling and their combs black. Towards the end of the outbreak the cases become less severe and some of the birds recover.

Infection takes place *via* the alimentary canal by means of food contaminated by the dejecta of birds suffering from the disease. The organism is found in the blood, internal organs and intestines in acute cases, but it is impossible to find it in chronic cases.

SECTION I.—EXPERIMENTAL INOCULATION.

Animals may be infected by inoculating them with a few drops of a 24-hour-old culture, or with the blood of an animal which has just died of fowl cholera, either sub-cutaneously or intra-peritoneally or—in the case of birds—in the pectoral muscle.

To produce infection in animals by feeding the food may be watered with a virulent culture or they may be fed upon the tissues of an animal which has died of the disease.

1. **Susceptible animals.**—Birds generally and especially small birds (sparrows, etc.) are very susceptible; they may be infected in various ways, though feeding often fails to produce the disease.

Rabbits are particularly susceptible to the fowl pasteurella, and may be easily infected by feeding or by sub-cutaneous inoculation. They die in the very early stages of the disease, before diarrhœa has had time to manifest itself, though on *post mortem* examination the intestine is found to be full of liquid matter. This fact affords an explanation of the rarity of the epizootic disease among rabbits, the excreta being the ordinary vehicle of infection.

Post mortem the stomach is distended, the blood black and hæmolyzed; there are numerous effusions of blood and the pleuræ on both sides are affected.

Mice and rats are very susceptible, and the ground squirrel should be mentioned among rodents susceptible to the disease. It was at Metchnikoff's suggestion that the bacillus of fowl cholera was used to start true epizootics among ground squirrels in order to diminish their numbers in parts of Southern Russia which were infested with them.

Guinea-pigs are fairly immune. The inoculation of a moderate dose of a virulent culture into the sub-cutaneous tissues does not kill the animal, but merely produces an abscess; the pus from the abscess contains but few micro-organisms but is nevertheless virulent for fowls. Guinea-pigs however generally succumb as a result of the injection of a virulent culture into the peritoneal cavity; and if a given culture be passed from animal to animal in this way its virulence can be increased sufficiently to kill a guinea-pig on sub-cutaneous inoculation.

Dogs and cats are only slightly susceptible; sub-cutaneous inoculation produces a swelling which quickly subsides and the animal recovers; intra-venous inoculation is followed by more severe results and may prove fatal. By passage through a series of dogs—or cats—the virulence of the organism for the species is considerably increased, and sub-cutaneous inoculation will then prove fatal.

Pigs are only slightly susceptible to sub-cutaneous inoculation but often die after intra-venous inoculation.

Sheep are susceptible, and succumb rapidly to the intra-venous inoculation of a highly virulent culture; with a less virulent virus the animal dies only after an interval of some days, having in the meantime suffered from a multiple purulent arthritis.

2. Symptoms and lesions.—The symptoms in the fowl will be described, as this is the animal most frequently used for experimental purposes. The disease in the rabbit has already been described.

A few drops of a virulent culture will kill fowls in 12–30 hours. In fulminating cases there are practically no symptoms; if however the animals live long enough the symptoms are the same as in the spontaneous disease:—at first the animal is unsteady and swells itself out, its feathers are ruffled and its comb black, then purging begins and the dejecta are mucous or blood-stained: finally the fowl becomes drowsy and comatose and death follows a series of convulsions. When inoculated with a less virulent virus the animal may recover from the disease or die after the lapse of several days with cachexia and arthritis of its hind limbs.

Post mortem, at the site of inoculation, there is a very small quantity of blood-stained œdema rich in bacilli. If the inoculated virus were only slightly virulent the œdema is more marked, and when the disease lasts for several days the infiltration is gelatinous, the pectoral muscle around the site of inoculation is swollen and yellowish in colour and may even have a lardaceous appearance (necrosis). The blood is black, coagulates feebly and has the appearance of being hæmolyzed, and contains the pasteurella in enormous numbers. The sub-cutaneous cellular tissues, the serous membranes and internal organs all show hæmorrhages: the lungs contain foci of infiltration, the liver is large, yellowish and friable, and the spleen swollen and softened. These last-named lesions are not however constant. The pericardium contains a clear serous fluid sometimes blood-stained or gelatinous; and a similar effusion is found in the pleural cavities in rabbits (birds do not possess a pleural cavity). The muscles and the heart are only affected if the disease has lasted several days; in that case they are soft and yellowish like a dead leaf. The intestine presents the lesions of enteritis, the mucous membrane being injected and ulcerated in patches. The intestinal contents are fluid and sometimes blood-stained. When the virus inoculated is only slightly virulent and death is delayed, arthritis of the joints of the posterior limbs can often be demonstrated on *post mortem* examination (Lignières).

As usual, the lesions are more marked the longer the animal lives.

SECTION II.—MORPHOLOGY.

1. Microscopical appearance.

The fowl pasteurella is a small bacillus or coccobacillus. The length does not exceed $0.5-1.25\mu$ and the breadth $0.25-0.40\mu$. In unstained preparations the organism has the appearance of more or less elongated points refractile in the centre and often arranged in pairs: it exhibits active Brownian movement but no movement of translation. In stained preparations, which are the best for a study of the morphology of the bacillus, it is seen to be oval in shape with rounded ends, and when lightly-stained preparations (thionin)

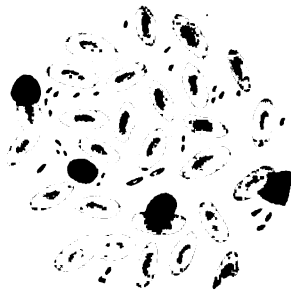

FIG. 225.—*Pasteurella gallinæ*. Film from fowl's blood. (Eosin and methylene blue.) (Oc. 2, obj. 1/4 th, Reich.)

are examined a small unstained refractile area is seen in the centre. In rapidly growing—young—cultures of the highly virulent strains, the rounded forms predominate and the appearance is suggestive of diplococci; in older or in less virulent cultures the elongated, bacillary forms are chiefly found.

The fowl pasteurella does not form spores.

Staining methods.—The bacillus is easily stained with the ordinary dyes, and is gram-negative.

(a) **Cultures.**—Stain with carbol-thionin, Kühne's carbol-blue or dilute carbol-fuchsin.

(b) **Scrapings of organs and blood films.** 1. *Simple staining.*—Stain for a few minutes with carbol-blue or carbol-thionin, wash, dry and mount. The leucocytes, the nuclei of the red cells and the bacilli are stained deep blue or violet.

2. *Double staining.*—Drop a little 1 per cent. aqueous solution of eosin on a blood film, leave for 2 or 3 minutes, wash, then pass through carbol-blue, wash again, dry and mount. This method gives exceedingly pretty preparations; the cytoplasm of the red cells is stained red by the eosin while their nuclei and the micro-organisms are blue (fig. 225). Unfortunately the technique is a little difficult: the action of the blue must be carefully watched under the microscope and the dye washed off as soon as the differentiation is complete.

(c) **Sections.**—Nicolle's tannin method should be used.

2. Cultural characteristics.

Conditions of growth.—The fowl pasteurella is primarily an aërobic organism. It will also grow in media deprived of oxygen, but anaërobic cultures are always very poor and can only be obtained under certain conditions, e.g. by sowing freely in serum broth. In aërobic cultures the organism grows feebly between 20° and 25° C.; the optimum temperature is from 35°–39° C.

The most useful media are chicken- or veal-broth made neutral or slightly alkaline, and especially broths containing serum.

Cultures in peptone broth produce indol but only after incubating for about a fortnight (Porcher and Panisset).

Characters of growth. Broth.—At 37° C. growth takes place rapidly in chicken-broth. A slight cloudiness is visible in about 10 hours which increases for the next 10–12 hours, then the growth deposits in the form of a scanty precipitate leaving the medium clear. Growth ceases in about a week.

The virulence of the culture reaches its maximum in about 24 hours; at this stage the rounded forms predominate, while in older cultures the long forms are the more numerous. When growth has ceased, the precipitate consists of granular debris in which no definite structure can be made out; if sown on a fresh medium, however, it will for some time give rise to virulent cultures.



FIG. 226.—*Pasteurella gallina*. Stab culture in gelatin (6 days).

Agar.—Growth is rapid at 37° C.; a thin white glistening streak is formed, thicker in the centre than at the edges. If a drop of blood be smeared on the surface of the agar, single colonies will usually be obtained which are at first transparent and bluish and later semi-opaque.

Coagulated serum.—The growth on this medium has the same appearance as the growth on agar.

Gelatin.—At 22°–23° C. growth is both slow and minimal in amount.

Stab culture gives a thin white line spreading out a little on the surface like a nail-head, the growth is very poor in the depth. *Stroke culture* produces a very fine whitish line which appears blue by transmitted light. The gelatin is not liquefied.

Potato : Yeast extract.—No visible growth occurs on these media.

Milk.—Growth takes place without coagulation of the medium.

SECTION III.—BIOLOGICAL PROPERTIES.

1. Vitality and virulence.

The fowl pasteurilla is a very delicate organism and rapidly dies out in culture. It is easily killed by drying, or by heating to 55° C., as well as by antiseptics or very dilute acids.

Cultures in liquid media are more resistant than those on solid media, but a broth culture dies out in about 6 weeks or 2 months, and while alive rapidly loses its virulence. The attenuation is due to the action of the oxygen of the air; infected blood stored in sealed capsules keeps its virulence for a long time, and a virulent culture may be similarly preserved by incubating it in broth for 18 hours and then sealing it up.

2. Attenuation—Vaccination.

The virulence of broth cultures kept at 37° C. is very materially reduced at the end of a fortnight; such a culture inoculated into a series of animals does not kill more than two or three out of every ten inoculated. A few days later still the culture has almost entirely lost its virulence: when inoculated into fowls it does not set up a fatal disease but merely a temporary indisposition, and if the pectoral muscle be the site of inoculation only a local lesion (gelatinous œdema, muscular sequestrum, or necrosis) results. The virulence of the attenuated virus though slight is however fixed, and by storing it in sealed capsules a culture with this character can be preserved: cultures of different degrees of virulence may also be kept under similar conditions.

It is always possible to make these cultures fully virulent by passage through sparrows; a virus which will not kill fowls is still fatal to sparrows and after a few passages will have fully recovered its virulence, so that on inoculation into fowls death results in a few hours.

It was when working with the bacillus of fowl cholera in 1878 that Pasteur discovered that organisms might lose their virulence, which observation was the basis of the discovery of vaccination with micro-organisms.

A fowl which has suffered from a mild attack of the disease following the inoculation of an attenuated virus is after recovery no longer susceptible to the disease; it can be inoculated with the most virulent strains without suffering any harm. Prophylactic vaccination is effected in practice by inoculating into the tip of the wing first a very attenuated virus and a few days later a second stronger vaccine. The animal is then immune for about a year.

3. Toxin.

Filtered broth cultures when inoculated into fowls produce a disease characterized by weakness and drowsiness from which the animals always recover and which confers on them a certain degree of immunity (Pasteur). Fowls which have been vaccinated with the micro-organism are still susceptible to the toxin.

Bisanti succeeded in immunizing rabbits by inserting a culture of the bacillus in a collodion sac beneath the skin or in the peritoneal cavity. Rabbits treated in this way were at the end of 20 days unaffected when fed on virulent cultures.

SECTION IV.—THE ISOLATION AND IDENTIFICATION OF THE ORGANISM.

The blood, the internal organs and the intestinal contents should provide the material for bacteriological examination.

1. Microscopical examination.—Films prepared with blood, scrapings of the internal organs or contents of the intestinal canal should be stained with carbol-thionin or carbol-blue and by Gram's method. Sections of the internal organs are particularly interesting and show the capillaries engorged with bacilli.

2. Cultures.—Tubes of ordinary broth or, better, veal broth, should be sown with blood from the heart or with a loopful of pulp from the spleen or liver.

At the *post mortem* a small stock of blood can be collected and stored for sowing cultures later. For this purpose aspirate the blood into a pipette (p. 75) and then seal, first the fine end then the constricted portion. Culture media sown with blood stored in this way will even many months later give growths of virulent organisms.

3. Inoculations.—Inoculation should be made for preference into a fowl or a rabbit. Blood from the heart or spleen pulp or better still a few drops of a recent culture in fowl broth or serum broth may be used.

Epizootics similar to fowl cholera in other birds.

The bacillus of duck cholera.—Cornil and Toupet described an epizootic among ducks which was characterized by diarrhoea, often blood-stained, and by feebleness and drowsiness. The disease is due to a small bacillus very similar to that of fowl cholera, from which it is only differentiated by the following characteristics.

1. It grows on potato giving rise to a scanty yellowish growth.

2. Cultures of the organism which are virulent for ducks are almost harmless to fowls and pigeons and are only fatal to rabbits when inoculated in large doses.

Lignières does not include this organism in the *pasteurella* group.

Klein's [so-called] bacillus of grouse disease.—A small, motile bacillus measuring 0.6–1.5 μ long, gram-negative, giving copious growths aëroically on broth, agar, gelatin (without liquefaction) and potato, coagulating milk and producing indol. [This organism appears to be the colon bacillus which invades the tissues of the birds after death.]

This bacillus should not therefore be included in the *pasteurella* group as defined by Lignières.

The bacillus of wood-pigeon disease (Leclainche).—A motile bacillus morphologically identical with Klein's grouse disease bacillus. It grows on potato and is virulent for pigeons, rabbits and guinea-pigs.

The bacillus of infectious enteritis of fowls (Klein).—The symptoms of the disease are very similar to those of fowl cholera. The bacillus presents the typical characteristics of the *pasteurella* group, is non-motile, gram-negative, does not liquefy gelatin and does not grow on potato.

The bacillus of epizootic dysentery in fowls and turkeys (Lucet).—This organism should be distinguished from the preceding (Lignières). It grows on potato.

The bacillus of coscoroba swan disease.—Trétrop described a disease which broke out among the Coscoroba swans in the Zoological Gardens at Antwerp.

The disease has the symptoms of duck-cholera, intestinal disturbances being the more prominent feature; it does not attack other species of swans, teal, ducks, nor geese which have been in contact with the sick birds. The cause of the disease is a small cocco-bacillus, indifferently aëroic, similar to the fowl *pasteurella* in appear-

ance and gram-negative. It is pathogenic for mice and swallows, guinea-pigs are only slightly susceptible, fowls and ducks are immune.

Trétrop was able with difficulty to vaccinate mice against the disease by treating them with cultures attenuated by heat (10 minutes at 58° C.).

The bacillus of hæmorrhagic septicæmia of ducks and fowls (Rabieaux).—This bacillus has all the characteristics of the fowl Pasteurella. It is an oval bacterium, non-motile, pleomorphic, gram-negative and does not grow on potato. It is pathogenic for ducks, fowls, pigeons, rabbits, guinea-pigs and white rats.

The repeated inoculation of filtered cultures of this bacillus or of cultures heated to 60° C. renders rabbits and guinea-pigs immune to the sub-cutaneous inoculation of living and virulent cultures, infected blood and other material.

2. PASTEURELLA CUNICULI.

(The bacillus of rabbit septicæmia).

A large number of dissimilar affections due to widely different organisms have been classed together under the head of "rabbit septicæmia," but many of these septicæmias are undoubtedly caused by an organism having all the characteristics of the pasteurella (*P. cuniculi*) first described by Th. Smith and more fully later by Thoinot and Masselin.

[C. J. Martin and Rowland have recently found that both plague (*B. pestis*) and rabbit septicæmia (*P. cuniculi*) may be encountered among rabbits in the same neighbourhood. "The co-existence of this latter disease [rabbit septicæmia] indicates the need for care in the diagnosis of plague among these rodents, as in the organs the cocco-bacilli of rabbit septicæmia may be microscopically indistinguishable from *Bacillus pestis*." ¹]

The bacillus described by Eberth and Mandry and isolated by them during an epizootic among rabbits is an oval-shaped motile organism, growing on potato, coagulating milk and producing indol. These characteristics should exclude it from the Pasteurella group which in all other respects it resembles. The bacillus of ferret septicæmia of Eberth and Schimmelsbuch is also wanting in most of the characteristics of a typical pasteurella.

The bacillus described by Lucet in a "new septicæmia of rabbits" in 1889 should apparently be included with the pasteurella, and also a micro-organism described by Lefebvre and Gautier in a septicæmia similar to that of Eberth.

1. **Experimental inoculation.**—Rabbits and guinea-pigs are equally susceptible to inoculation with the rabbit pasteurella; all birds are also susceptible. A young broth culture or material (blood, spleen or liver tissue) from an animal recently dead of the disease may be used; intraperitoneal inoculation is more rapidly fatal than sub-cutaneous inoculation.

[Martin and Rowland found rats and guinea-pigs to be unaffected by a dose of culture which killed large rabbits in less than 18 hours.]

Symptoms appear on an average about 20 hours after inoculation. The animal is weak and refuses its food, respiration is quickened, locally there is a swelling at the site of inoculation, diarrhœa supervenes and later the animal becomes comatose and dies.

Post mortem, the venous system is engorged with thick, dark-coloured blood, the trunk muscles are of a reddish purple colour, the abdominal cavity contains a large quantity of thick, blood-stained

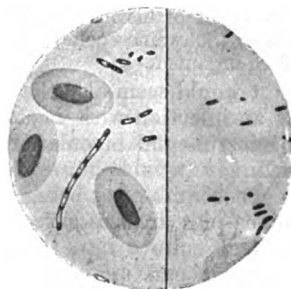

FIG. 227.—*Pasteurella cuniculi*. On the left a film from sparrow's blood; on the right a film from the liver of a sparrow.

¹ Report Medical Officer, Local Government Board, 1910-11, Cd. 5939.

fluid, the lungs are congested and seem to float in a blood-stained effusion, and the pericardium is full of fluid which is also occasionally blood-stained.

2. [Post-mortem appearances in naturally infected rabbits and in spontaneous plague in rabbits. (a) Rabbit septicæmia.—In a case observed by C. J. Martin and Rowland the right superficial inguinal gland was red and swollen, and the vessels in the neighbourhood congested. The skin generally was injected, and both skin and peritoneal lining had a pink flush. The spleen was enlarged and tense, and the liver mottled. The pleuræ and pericardium were full of fibrinous exudation, the heart being adherent to the parietal pericardium and the lungs to the pleuræ. There was double pneumonia. The organism was found in the pleural exudate, lungs, spleen and enlarged glands.

[(b) Plague.—In another rabbit from the same neighbourhood these observers found a plague-infected rabbit which showed the following lesions: a typical sub-maxillary bubo, and marked injection of the vessels in the skin. The spleen was much enlarged tense and of a purplish colour. The peritoneum and pleuræ contained blood-stained fluid. The left lung was congested but not consolidated. The intestines were matted together by recent lymph.

[In a second rabbit the only lesion was a greatly enlarged spleen full of nodules.]

3. Morphology.—Microscopically the organism is similar to that of fowl cholera (*q.v.*) [and may be indistinguishable from *Bacillus pestis*]. Its growth on gelatin is white, slightly viscous and rather more abundant than that of the fowl cholera bacillus.

3. PASTEURELLA SUIŒ.

(The bacillus of contagious pneumonia of pigs or swine plague).

Ger. *Schweineseuche*. Fr. *Pasteurellose du porc*.

The contagious pneumonia of pigs, known in America as "Swine plague" and in Germany as "Schweineseuche," and caused by an organism of the pasteurella group, must be carefully distinguished from Hog Cholera¹ (Chap. LXIV.) with which it was for a long time confused.

Clinically the differential diagnosis is very difficult and sometimes impossible, and further, as Karlinski has shown, an animal may suffer from the two diseases at the same time. Bacteriologically, the micro-organisms are very different; the organism of swine plague belongs to the pasteurella group and is closely allied to the bacillus of fowl cholera, while the Hog Cholera bacillus or *Bacillus suispestifer* belongs to the Salmonella group (p. 431). It should be stated however that Hutyrá, as a result of his investigations, inclines to the belief that hog-cholera and swine plague (*Schweineseuche*) are one and the same disease and due to an invisible micro-organism.

[It would seem also that the pasteurella infection of pigs may be mistaken for an infection with *Bacillus pestis* (cf. p. 461).]

Experimental inoculation.—The virulence of the swine pasteurella is exceedingly variable but if low is easily increased by passage. Mice and rabbits soon succumb after being inoculated sub-cutaneously with a virulent strain; guinea-pigs are less susceptible; in pigeons the inoculation of 0.5 c.c. of a virulent culture into the muscles proves fatal. Fowls are more resistant, but the inoculation of a virus which has been increased in virulence by passage through guinea-pigs and chickens produces a fatal result. Dogs, sheep and bovine animals succumb to intra-venous inoculation.

Pigs as a rule after being inoculated sub-cutaneously merely suffer from a local œdema at the site of inoculation and a transitory rise of temperature; when inoculated however with a very virulent virus a fatal result may ensue.

[¹ Hog cholera is also known as swine fever and swine typhoid and in Germany as *Schweinepest*.]

Post mortem, the spleen and liver are enlarged, there are patches of broncho-pneumonia in the lungs, and pericarditis; the blood is dark-coloured and like pitch: the organism is present in very large numbers in the blood, liver, spleen, pericardial fluid, etc.

Intra-venous inoculation leads to more severe symptoms: if the culture be virulent, death from septicæmia soon takes place: with an attenuated virus a condition of cachexia accompanied by synovitis and arthritis is more or less rapidly set up.

It is difficult to infect pigs by feeding them.

Morphology.—Morphologically the organism is identical with the other members of the pasteurilla group. The swine pasteurilla however grows more easily than the fowl pasteurilla; it can be grown at 20° C. and can be cultivated anaërobically with but little difficulty.

Vaccination. Serum therapy.—Swine which have recovered from an attack of contagious pneumonia are found to be immune. Immunity may be produced experimentally by the inoculation of blood sterilized by heat (Selander and others) or by the injection of small doses of the virus (Metchnikoff) or of old cultures (Detmers).

Rabbits may be immunized by inoculating them with the serum of rabbits which have been vaccinated with small doses of the virus (Metchnikoff). De Schweinitz, Reters and Leclainche have also obtained a prophylactic and therapeutic serum.

Rabbits which have been vaccinated with attenuated strains of the swine bacillus are immunized not only against the swine bacillus but also against the fowl and rabbit varieties. Fowls which survive the inoculation of the swine bacillus are immune against the bacillus of fowl cholera (Chamberland and Jouan).

Chamberland and Jouan having immunized an horse against the swine bacillus by sub-cutaneous inoculation showed that the serum of the horse possessed prophylactic properties equally for the swine, the avian and the rabbit bacillus. It agglutinated most strains of the pasteurilla group, viz.: the swine bacillus in dilutions of 1 in 60,000, the pasteurilla of guinea-pigs in 1 in 4,000, the fowl and ovine varieties in 1 in 1,000.

4. PASTEURILLA BOVIS.

Under the name "Wild und Rinderseuche" Bollinger first described an epizootic disease occurring among stags, wild boars, deer, roebucks and cattle, and caused by an ovoid bacterium. The disease sometimes takes the form of an acute hæmorrhagic septicæmia, sometimes it is more chronic and accompanied by pulmonary localizations. Oreste and Armani found an identical micro-organism in an epizootic disease of buffaloes—"Barbone"—and numerous investigators have since described similar epizootics in which the same organism was found (Galtier, Billings, Smith, Nocard, Piot-Bey and others). In the Argentine, Lignières observed various clinical forms (acute enteritis, pleuro-pneumonia and hæmorrhagic septicæmia) of an epizootic disease caused by one and the same micro-organism which was indistinguishable from the foregoing.

These various affections may be classed together under the general term

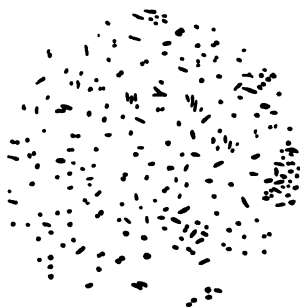

FIG. 228.—*Pasteurella suis*. Film from an agar culture—carbol-thionin. (Oc. iv, obj. 1/3th, Reich.)

“Bovine pasteurelloses.” The bovine pasteurella is fatal to mice, rabbits and guinea-pigs on sub-cutaneous inoculation, and to oxen, sheep, dogs, horses, pigs, pigeons and fowls on intra-venous inoculation. The cultural characteristics and staining reactions are the same as those of the fowl pasteurella. Similar methods must also be adopted in examining tissues for the organism and in isolating the bacillus; it can only be found in the tissues of animals which have died of the acute forms of the disease, and it gives very scanty growths under anaërobic conditions.

Oreste and Armanni have been able to vaccinate buffaloes against *barbone* by inoculating them with attenuated cultures.

Vassal immunized a number of calves by introducing into the peritoneal cavities of the animals a Chamberland bougie filled with a broth culture of the bacillus and hermetically sealed. Animals thus immunized with the toxin stood the test inoculation and also yielded a serum having therapeutic properties.

5. PASTEURELLA OVIS.

Different names have been given to the epizootic disease of sheep caused by the sheep pasteurella, *e.g.* pneumo-enteritis (Galtier); various epizootics described by Lignières and perhaps also some described by other investigators (Mercanti and Deny, Benoist and Caillé and others) are due to this bacillus.

The sheep pasteurella has all the characteristics of the group as already described. It is somewhat difficult to grow when taken direct from animals which have died of the spontaneous disease. The bacillus is always found in the acute but very rarely in the chronic forms of the disease: it is pathogenic for mice, rabbits, guinea-pigs, dogs, sheep and oxen.

6. PASTEURELLA CAPRÆ.

(The bacillus of infectious pneumonia of goats.)

The infectious pneumonia of goats which occurs at the Cape, in India, Germany, France, Turkey and elsewhere has been investigated bacteriologically by M. Nicolle and Réfik Bey in Turkey. It is caused by a Pasteurella which is easily isolated from the lesions in the lungs and from the mucous secretions.

This micro-organism has all the group characters of the pasteurella. It is rapidly fatal to mice, rabbits and pigeons on sub-cutaneous inoculation, to guinea-pigs when inoculated intra-peritoneally, and to goats and calves on intra-pulmonary inoculation. Sub-cutaneous inoculation of goats slowly produces a condition of cachexia.

Animals can be immunized by the inoculation of sterilized cultures.

7. PASTEURELLA EQUI.

(The bacillus of hæmorrhagic septicæmia of horses.)

A large number of diseases of horses having very different clinical features (typhoid fever, influenza, contagious pneumonia, pneumo-enteritis, pernicious anæmia) appear to be due to one and the same micro-organism, the equine pasteurella (Lignières); but the primary (pasteurella) infection may be followed by a secondary infection, so that the former may become obscured. Possibly the disease itself is a secondary infection following an infection with an invisible micro-organism (Chap. LXIV.).

The equine pasteurilla often passes unnoticed while the micro-organisms of the secondary infection—especially in cases of strangles and contagious pneumonia—are found in large numbers.

Cultures are only obtainable with difficulty direct from the tissues of the horse. To recover the organism from suspected material it is best to inoculate a guinea-pig intra-peritoneally and then to sow cultures with the peritoneal fluid of the guinea-pig, but even then it is often impossible to recover the organism.

The equine bacillus kills guinea-pigs and rabbits and sometimes horses on sub-cutaneous inoculation. Horses succumb to intra-venous inoculation. It is only slightly pathogenic for fowls and pigeons and these birds only succumb after intra-venous inoculation of one or several cubic centimetres of the peritoneal exudate of an infected guinea-pig. Rats and oxen are immune.

Morphologically the organism differs in no way from the other members of the group.

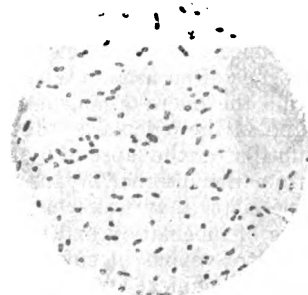

FIG. 229.—*Pasteurella equi*. Film from the peritoneal exudate of a guinea-pig—carbolic-thionin.

8. PASTEURELLA CANIS.

(The bacillus of distemper.)

Distemper, which attacks chiefly young animals and assumes very various forms (typhoid fever, dog-plague, dog-pox, infectious pneumonia, gastro-enteritis etc.), [has been attributed] to a pasteurilla (Lignières, Phisalix). Distemper in the cat is due to the same organism (Lignières).

Phisalix investigated a septicæmic condition in guinea-pigs accompanied by the lesions of pneumonia. He found it to be due to a small bacillus having all the morphological and cultural features of a typical pasteurilla and pathogenic for rabbits, mice, pigeons and dogs. Phisalix considered that his bacillus was identical with that which Lignières later described in distemper in dogs.

The micro-organism of distemper is somewhat difficult to isolate from the tissues of the dog: it can only be found in the acute forms, and is most easily recovered from the blood stream, but secondary infections rapidly supervene with the result that the pasteurilla disappears.

Carré diluted the nasal secretions with sterile water and after filtering the emulsion through a very porous bougie obtained a filtrate, sterile on cultivation but capable of infecting fresh animals. From these experiments it may be concluded that the true virus of distemper is an invisible micro-organism, the pasteurilla being present merely as a secondary infection. It may be necessary to review the ætiology of "distemper," since it is possible that some of the clinical conditions known by this name are due to a pasteurilla others to a filtrable virus (Chap. LXIV.) [and see also M'Gowan's bacillus, *infra*].

Experimental inoculation.—The dog pasteurilla is only slightly virulent for animals other than the dog and cat.

It kills mice and guinea-pigs on intra-peritoneal inoculation with the lesions of acute peritonitis. *Post mortem*, the intestine, liver, kidneys and spleen are congested: the organism can be recovered from the blood and is also present in large numbers in the peritoneal exudate.

Rabbits succumb to intra-peritoneal inoculation: intra-venous and sub-cutaneous inoculation is also fatal if a very large dose of the virus be given,

or if a bacillus the virulence of which has been increased by passage through rabbits or guinea-pigs be inoculated. Birds (fowls, pigeons and ducks) can only be killed by inoculation of a bacillus the virulence of which has been increased by passage through guinea-pigs.

Broth cultures of a strain recently isolated from the tissues of a dog are pathogenic for dogs and cats. Sub-cutaneous inoculation of such cultures produces a disease which in adult dogs tends to recovery but which in young dogs is often fatal. When the animal dies within 4 or 5 days of the inoculation the micro-organism can be found in the blood, internal organs, glands, and in the œdema at the site of inoculation. If death does not take place until after the lapse of 5 or 6 days, cultures sown with the blood or scrapings from the internal organs yield various organisms but not the pasteurilla: the latter may however be found in the fluid from the local œdema at the site of inoculation and in the lymphatic glands.

Intra-venous inoculation of cultures is fatal to dogs and gives rise to the various clinical symptoms of the disease. Inoculation with small doses of the virus produces gastro-intestinal symptoms. The condition though apparently tending to recovery slowly leads to death from cachexia; the micro-organism can only be isolated from the tissues during the first week after inoculation. Lignières failed to infect dogs by feeding them.

It is very difficult to transmit the disease by direct inoculation of material obtained from diseased animals: the fluid in the pustules is not virulent. Occasionally, when the discharge from the nose or the pulmonary exudate or blood have been used, sub-cutaneous or intra-venous inoculation has given positive results. The most successful results have been obtained by painting the nasal fossæ of young dogs with the nasal discharge of sick animals.

Morphology.—The canine pasteurilla exhibits the ordinary morphological features of the group: when taken direct from the tissues of the dog it is a fairly long bacillus, but after the first passage through guinea-pigs it assumes the shape of a cocco-bacillus. It grows well at 18°–20° C. and better on coagulated serum than on agar.

Toxin.—Phisalix obtained a toxin, which killed rabbits, by growing the canine pasteurilla in ordinary broth or better in peptonized Liebig's broth for 5 days, and with it was able to reproduce experimentally most of the clinical features of the disease as seen in dogs: it lowers the resistance of the inoculated animal and favours the development of secondary infections. Guinea-pigs are only slightly susceptible to the action of the toxin.

The toxin obtained on killing cultures with ether or chloroform is found to be much more virulent than that prepared by filtration.

Vaccination.—Phisalix, applying the method of attenuation adopted by Pasteur for fowl cholera, has prepared a vaccine which seems to give good results in veterinary practice.

Dogs should be vaccinated when about 2 months old. Two inoculations (each of about 3 c.c.) are given beneath the skin at an interval of a fortnight. The inoculation is not dangerous and immunizes the dog sufficiently to protect it against the spontaneous disease.

The vaccines of Phisalix do not protect dogs against intra-venous inoculation. For practical purposes there is no need to produce a high degree of immunization, and moreover if carried too far it may lead to the development of visceral and more particularly renal lesions (dogs can be highly immunized by repeatedly inoculating them with viruses of increasing virulence).

Lignières prefers to use a polyvalent vaccine which gives more constant results than the monovalent vaccine of Phisalix.

[M'Gowan's bacillus of distemper.]

[M'Gowan¹ has recently brought forward evidence to show that "Distemper" is due to a gram-negative, non-spore-bearing slightly motile bacillus.

[The organism was recovered from a large number of more or less diseased animals of different species: in all the primary focus of the disease was the respiratory tract. The dogs and cats from which the organism was isolated showed the symptoms commonly associated with "distemper."

[The organism measures when taken from the tissues from 0.5–2.3 μ long by about 0.4–0.5 μ broad. It grows on all the ordinary media both aëroically and anaëroically and does not liquefy gelatin.

[It forms neither acid nor gas in a peptone-salt medium containing any of the following carbohydrates: lactose, saccharose, salicin, mannite, dulcitol, maltose, galactose, raffinose, glucose, inulin, inositol, adonitol. On the other hand, the solutions become markedly alkaline after a few days.

[Litmus milk is turned alkaline and not coagulated.

[“On potato the growth is characteristic, the appearance being that of a buff-coloured, or yellow to copper-brown, raised, moist, heavy growth. The brownish colour is perceptible in 24 hours and is very evident in 48 hours” (M'Gowan).

[On intra-peritoneal inoculation the organism was pathogenic to a large variety of animal species including dogs and cats, and there is evidence “that the organism in pure culture can produce in healthy dogs, when applied to their nasal mucous membrane, the clinical symptoms of “distemper.”]

9. IMMUNIZATION WITH THE POLYVALENT VACCINES OF LIGNIÈRES.

Starting with the idea that an animal may be infected with several varieties of pasteurilla, Lignières recommends the use of polyvalent vaccines. The vaccine is prepared by mixing cultures of the sheep, ox, dog, horse, pig, and fowl varieties. In order to avoid any changes in virulence, only cultures which have been grown on agar in the laboratory for at least a year and have been re-sown every other day are used. To prepare the vaccines, these cultures are sown in flat-bottomed flasks containing a shallow layer of broth and incubated at 42°–43° C. for 5 days for the first vaccine and for 2 days for the second.

The dose of each vaccine varies from 0.125–1 c.c. according to the size of the animal, and the two inoculations are given sub-cutaneously at intervals of 12 days or a fortnight. The resulting immunity lasts, on an average, 12 months.

Polyvalent serum.

Lignières and Spitz prepared a polyvalent serum which was both prophylactic and curative.

Mixed cultures of the six varieties of the pasteurilla which have been kept on agar for a year, and sown as described above, are injected into horses in repeated small doses (5–20 c.c.) at intervals of a few days first under the skin then into the veins. After each inoculation the animals show a sharp reaction lasting 2 or 3 days.

The serum so obtained is prophylactic and curative but has no antitoxic properties. In doses of 40–60 c.c. it gives the best results in the treatment of the equine pasteurilosis, and in doses of 5–10 c.c.—if given at the onset of the disease—it is [said to be] very efficacious in the treatment of distemper in dogs.

¹ *Journal of Pathology and Bacteriology*, xv. p. 372.

CHAPTER XXIX.

BACILLUS PESTIS.

Introduction.

Section I.—The experimental disease, p. 463.

Section II.—Morphology, p. 464.

1. Microscopical appearances and staining reactions, p. 464. 2. Cultural characteristics, p. 465.

Section III.—Biological properties, p. 466.

1. Vitality and virulence, p. 466. 2. Bio-chemical reactions, p. 467. 3. Toxins, p. 467. 4. Vaccination, p. 468. 5. Serum therapy, p. 471. 6. Agglutination, p. 472. 7. Precipitins, p. 473.

Section IV.—Isolation and identification of the plague bacillus (including an account of the *post mortem* appearances in the naturally infected rat), p. 473.

THE bacillus of plague was discovered in 1894 by Yersin [and Kitasato independently].

In the human subject plague may assume one of two forms, bubonic or pneumonic; of the two the former is the more common. [In both forms a septicæmia may occur, generally as a late symptom, but it is incorrect to speak of a septicæmic as opposed to a bubonic and a pneumonic form (Simond).]

In bubonic plague the bacillus is present in the pus of the lymphatic glands and occasionally in the blood and more rarely in the stools (Wilm). [In India the Advisory Committee¹ found that in a large proportion of cases (67 per cent.) the bacillus is present in the blood and that a bacilluria occurs in about 30 per cent. of cases. In bubonic plague it is not uncommon for a secondary pneumonia to develop.]

In the pneumonic form, though there is an absence of buboes, the bacillus is present in the lymphatic glands. It is frequently present in the blood and always in the sputum (Métin indeed demonstrated the presence of bacilli in the sputum of plague patients a week after the temperature had fallen to normal, but could detect them only by inoculation and found their virulence was attenuated); bacilli can also be found in the juice and in sections of the lung and spleen (Tchistowitch).

According to Haffkine the native races of India are more susceptible to plague than are either white people or the native races of Africa.

In epidemics of plague, rats are, as a rule, the first to suffer. "Plague which is at first a disease of rats soon becomes a disease of man" (Roux and Yersin).

[Besides its occurrence in rats natural plague has been observed in guinea-pigs in India (Indian Commission); in rabbits in India (Indian Commission) and in England (Martin and Rowland); in apes—*Cynopithecus niger*—and monkeys—

[¹ The reports on plague investigations in India issued by the Advisory Committee appointed by the Secretary of State for India, the Royal Society and the Lister Institute are published in the *Journal of Hygiene*, 1906, 1907, 1908 and 1910.]

Macacus sinensis, *Semnopithecus entellus*, *Macacus nemestrinus*—in the Bombay Zoological Gardens (Indian Commission); in cats in the Azores (de Souza, Arruda and Pinto); in ground-squirrels—*Citellus beecheyi*—in America (M'Coy); and in brush rats—*Neotoma*—(M'Coy). The disease is also believed to occur in the marmot—*Arctomys bobax*—(vide *infra*). The infection of the ground-squirrels on the Pacific Coast of the United States of America was believed to be the source of infection in a number of cases of plague in that district.]

During epidemics of plague a large number of animals [other than those mentioned have been said to be] affected at the same time as man: [Simpson, for example, stated that pigs, calves, buffaloes, sheep, hens, ducks, geese, turkeys and pigeons are susceptible. But Bannerman and Kápadia, as Members of the Commission appointed by the Advisory Committee, failed to infect pigs, calves, fowls, turkeys, geese and ducks, and showed that buffaloes are not susceptible. The conclusions of the Indian Commission are supported by many other observers among whom may be mentioned Pearse in Hong-Kong, London in Russia, Watkins-Pitchford in Natal and de Souza, Arruda and Pinto in the Azores. The last named observers further showed that dogs are practically refractory to plague and that ferrets are only susceptible to large doses of the virus. From these and other facts it appears, as Bannerman points out, that Simpson confused the plague bacillus with the hog-cholera bacillus (p. 438) and with the bacillus of fowl cholera (p. 447).]

Plague is transmitted from rat to rat and from rat to man by fleas (Simond). [The rat flea, *Xenopsyllus (Pulex) cheopis* Rothschild, under certain circumstances is attracted by man and will readily bite and feed on him (Advisory Committee).¹]

[It is possible to transmit plague by means of *Pulex irritans*. Nevertheless the direct transmission of the disease from man to man cannot, at the present time, be of frequent occurrence or we should have evidence of direct infection instead of dependence upon the epizootic. The reason why the human flea is ineffective is because in human cases the average degree of septicæmia before death is so much less than in rats that the chance of a flea imbibing even a single bacillus is small (C. J. Martin).]

Rats suffering from plague are a ready prey to fleas and plague bacilli have been found in the stomachs of these insects. If a flea be taken from a plague-infected rat, crushed in a mortar and inoculated into a mouse, the latter becomes infected with plague [Ogata].

[There is good evidence that the plague bacillus multiplies in the stomachs of fleas (Indian Commission).]

[Simond holds that when a flea bites man or the lower animals it discharges the contents of its intestine near the bite; should the flea be infected the plague bacillus—which will be present in the excreta—will be rubbed into the bite by the scratching induced as a result of the bite. The experiments of the Advisory Committee would appear to support this view. Both male and female fleas bite.]

A healthy rat coming in contact with fleas from a plague-infected rat dies of plague. When a rat dies the fleas leave the carcass.

Plague is similarly transmitted by fleas from man to man. In the early stages of an infection with the plague bacillus small inflamed areas are occasionally seen, varying in size from a pin's head to a walnut, transparent at first then purulent and always containing bacilli. These inflammations are found on parts exposed to the bites of insects, and it would appear that they mark the sites of inoculation. Sticker, working in Bombay, pricked himself with an infected instrument and after 3 days an inflammation appeared at the site of the injury and symptoms of plague manifested themselves.

[*Xenopsyllus cheopis* is, except in Northern and Central Europe, the commonest flea found on house and port rats all over the world and in some localities is almost the only flea found. *Ceratophyllus fasciatus* is the flea usually found on *Mus decumanus* in Great Britain (*M. rattus* is a rare animal in the British Islands), and this is also the case, apparently, throughout Northern and Central Europe (Rothschild).]

[*X. cheopis* is identical with *P. pallidus* Taschenberg, with *P. murinus* Tiraboschi and with *P. philippinensis* Hertzog.

[*P. irritans*, the flea commonly found on man, *Ctenocephalus canis*, of dogs, cats, etc., and *Xenopsyllus musculi*, the common house mouse flea, have occasionally been found on rats.]

[Plague may also possibly be transmitted from man to man through the agency of bugs. Nuttall found plague bacilli in the intestinal canal of bugs and has shown that they can convey the infection of plague from infected to healthy animals. Verjbitaki showed that the ordinary domestic bug, *Cimex lectularius*, will bite mice, rats, and guinea-pigs, and that plague bacilli can be recovered from these insects for periods varying from 1-8 days after they have been fed on septicæmic animals. Jordansky and Kladnitsky find that the plague bacillus retains its virulence in the bodies of bugs for 10 days and more.]

Flies may also play a part in the dissemination of plague. They die in large numbers during an epidemic of plague and the bacillus can be found in their bodies (Yersin). [Jordansky and Kladnitsky are however of opinion that neither flies, cockroaches nor ants play an important part in plague.

[Ogata has suggested that mosquitoes may convey the infection from the diseased to the healthy subject.]

Infection by feeding.—Man only very rarely becomes infected through the alimentary canal (Wilm has recorded one case in which the most prominent symptoms were intestinal and in which the bubo was found to be in the mesenteric glands). [With regard to animals the Advisory Committee find that "in nature intestinal infection rarely or never takes place and that in consequence rats do not become infected by eating the carcasses of their comrades"; cf. experimental feeding experiments (p. 464).]

[“The position of knowledge on the question of the importance of alimentary infection in the spread of plague may be summarized as follows:

[1. Contamination of aliments may conceivably lead to the infection of human beings on occasion, but the chance of bacilli reaching foodstuffs destined for consumption uncooked, and in which they would multiply greatly, are slight.

[2. The alimentary canal is not an easy method of infecting animals, large quantities of virulent bacilli being usually necessary.

[3. There is absolutely no epidemiological evidence pointing to alimentary infection being anything but uncommon, and in about 75 per cent. of human cases, the situation of buboes indicates skin infection” (C. J. Martin).]

Infection by the respiratory passages is easily effected in animals, and is not of rare occurrence in man: “it would appear to be the only channel of infection in pneumonic cases” (Balzaroff). [“Pneumonic plague may arise by the inhalation of bacilli into the lungs, where they rapidly multiply and early gain access to the blood stream, or bacilli which have gained entrance through any other channel and have become generalized may subsequently establish themselves in the lungs and occasion a secondary pneumonia. Some degree of secondary pneumonia is not uncommon in man and animals suffering from bubonic plague. A case of bubonic plague may therefore become a potential source of a pneumonic outbreak. The spread of the pneumonic form of the disease offers no difficulties, since it was shown by Childe that the sputum of these cases contains innumerable bacilli, and by Martini that plague pneumonia is readily produced in animals exposed to an atmosphere containing droplets of an emulsion of plague culture. Pneumonic plague is obviously spread by man-to-man infection” (C. J. Martin).

[In the recent epidemic of pneumonic plague in Manchuria, rats were not attacked by the disease, but the tarbagan (*Arctomys bobac*¹) was held to be responsible for the presence of endemic plague in Mongolia and in the Russian provinces adjacent. The connexion between the tarbagan and plague has not been satisfactorily worked out, but all the evidence available seems to show that there might be truth in the belief of the infective power of the marmot in this connexion. The origin, however, of the pneumonic plague in Manchuria has yet to be discovered (Petrie).

[However probable it may seem on the evidence at present available it cannot be said to be proved that contact alone is the only factor concerned in the spread of pneumonic plague. Though “some degree of secondary pneumonia is not uncommon in man and animals suffering from plague” (Martin) yet the experience in plague hospitals in India is opposed to the view that infection takes place by direct contact with a patient suffering from plague and in the laboratory the Advisory Committee found that “fleas and fleas alone were the transmitting agent in the experimental production of plague epidemics among animals.” Since then contact

[¹The Bobac or Polish marmot.]

can be definitely excluded as a source of infection in India it is difficult to understand how it alone will explain the Manchurian epidemic.]

The plague bacillus is capable of retaining its vitality outside the body. Yersin recovered a plague bacillus, less virulent it is true than those isolated from buboes, from the soil of an infected place. [In moist earth previously sterilized the bacillus will survive for months (Gladin, Marsh).] In the bodies of dead rats the organism can retain its virulence for several weeks (Maassen). According to Inghilleri the plague bacillus is able to live in drinking water for about a month.

SECTION I.—THE EXPERIMENTAL DISEASE.

Monkeys, mice, rats, guinea-pigs and rabbits are all very susceptible to experimental infection with plague: [but domestic animals such as horses, cattle, sheep, goats, pigs and calves, pigeons, geese, fowls, ducks and turkeys are apparently not susceptible "either by ingestion, scarification or sub-cutaneous inoculation" (Bannerman and Kápadia, Haffkine, London, Watkins-Pitchford, de Souza, Arruda and Pinto).] De Mattei affirms however that pigeons, fowls and ducks succumb if inoculated with large doses of virulent cultures.

Cultures of the plague bacillus are very virulent for man, and accidents in laboratories have shown that a certain element of danger attaches to working with the organism.

1. Sub-cutaneous inoculation.—To infect a monkey, a mouse, [or other susceptible animal] with plague it is only necessary to scratch the skin lightly with a needle charged with the virus. Rats and mice die in 2 or 3 days, guinea-pigs in 2–5 days and rabbits in 3–8 days.

A few hours after inoculating a guinea-pig a localized œdema makes its appearance at the site of inoculation followed by a swelling of the related glands; at the end of 24 hours the animal will be found lying on its side and its coat ruffled: death is preceded by convulsive seizures.

Post mortem there is a reddish œdema at the site of inoculation and around the neighbouring gland: the abdominal organs are congested while the spleen is very much enlarged and often exhibits an eruption simulating small miliary tubercles. [When the disease has been of some duration abscesses are occasionally found in the abdominal wall.] There is a small amount of serous exudate in the pleuræ and peritoneum and bacilli can be demonstrated in the fluid: bacilli are also to be found in large numbers in the lymphatic glands, liver, spleen and blood.

The virulence of the organism is increased by passage through guinea-pigs using in the first instance a scraping from the spleen or a little blood.

By passing the virus through a series of animals of the same species bacilli can be obtained which are of an exalted and constant virulence for that species. For instance a bacillus can be recovered which will consistently kill a mouse in 2 days; one which will kill a guinea-pig in 2 or 3 days; or one which is fatal to a rabbit in 3 days. A bacillus which will kill a mouse in 2 days takes rather a long time to kill a rabbit, but after being passed through a few rabbits will kill these animals in 3 days; it has however now lost its virulence for the mouse and to restore its virulence for the latter species it must be passed from mouse to mouse a few times (Yersin, Calmette and Borrel).

[No alteration in virulence for rats is observed after sub-cutaneous passage through rats.]

2. Cutaneous inoculation.—Guinea-pigs are readily infected by rubbing infected material on the surface of the shaved skin (Weichselbaum, Albrecht and Ghon). A slight inflammation first forms and the disease then runs the same course as in the previous case.

This affords a valuable test for the detection of plague bacilli in material contaminated with other organisms, and is the method which should be adopted for the detection of the bacillus in decomposing carcasses, fecal matter, etc.

3. Intra-venous inoculation.—Inoculation into the veins leads to a more severe disease in laboratory animals than sub-cutaneous inoculation: apart from the local lesion the symptoms are similar in the two cases.

4. Intra-peritoneal inoculation.—This mode of infection is very severe: an inoculated guinea-pig will die in 24–40 hours. The virulence of the bacillus can be increased by passage through animals by means of collodion sacs inserted into the peritoneal cavity (Roux).

5. Infection of the mucous membranes.—An animal can be infected through any of the mucous membranes (nasal, conjunctival, buccal, vaginal, etc.).

Rats, mice, guinea-pigs and rabbits die of plague if a trace of the virus be placed on the nasal mucous membrane without injuring it. The disease can be more surely transmitted by this method than by sub-cutaneous inoculation (Roux and Balzaroff).

An attenuated virus which fails to give rise to a fatal infection when inoculated hypodermically will produce the pneumonic form of the disease when inoculated into the respiratory passages, and the virulence of the organism can be recovered in this way, for example by successive passages on the nasal mucous membrane. A virus which has been dried even for several weeks in albuminoid matter gives rise to the pneumonic form of the disease when inoculated into the nose.

6. Ingestion.—Rats, mice and monkeys may be infected by feeding them on living cultures (Simond) or on the viscera of plague-infected animals.

[The Advisory Committee found that about one-fourth (26·2 per cent.) of the rats which they fed on the whole carcasses or viscera of infected rats and guinea-pigs contracted plague. The majority died on the third and fourth days after receiving the plague-infected meat, though in a few cases death was delayed as long as three weeks. Among the (437) rats which were still alive at the end of three weeks 11 showed undoubted signs of being plague-infected. *Post mortem* examination of the rats which died showed lesions similar to those found in rats naturally infected save in two very important particulars. In rats infected by feeding the mesentery was by far the commonest situation for the bubo, and in about one-third of the number the Peyer's patches were enlarged, congested, hæmorrhagic and often ulcerated, and the intestines markedly congested (cf. appearances presented by naturally infected rats p. 474).]

7. Contagion.—If a number of healthy mice be placed in a bottle with a number of inoculated mice the former contract the disease and die with lesions characteristic of plague (Yersin): [but the Advisory Committee showed that "close contact of plague-infected animals with healthy animals, if fleas are excluded, does not give rise to an epizootic among the latter" and that aerial infection is not a means whereby the disease is spread from an infected animal to a healthy animal.]



FIG. 230.—*Bacillus pestis*. Scraping from a lymphatic gland. (After Yersin).

it very closely resembles the bacilli of the *pasteurella* group, the bacillus *pseudo-tuberculosis rodentium*, and often bacilli of the *typhoid-colon* group.]

SECTION II.—MORPHOLOGY.

1. Microscopical appearance.

The micro-organism of plague as seen in preparations from the tissues is a short, squat bacillus with rounded ends and is more correctly described as a cocco-bacillus: it measures about $2 \times 1 \mu$. [*Morphologically*

The bacillus does not form spores, and is generally said to be non-motile, [but Gordon states that it is furnished with flagella and is motile]. In preparations made from blood the organism is rather longer than in the buboes and often appears as though surrounded by an hyaline capsule.

In broth cultures the organism grows in chains. On agar more or less elongated forms are seen among the ordinary short cocco-bacillary forms.

In old cultures and on agar containing salt [2-5 per cent.] the plague bacillus gives rise to *involution forms* consisting of large ball-like swellings and under these conditions the organisms stain feebly (fig. 232).

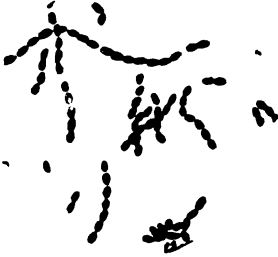

FIG. 231.—Plague bacillus. From a broth culture. (After Yersin.)

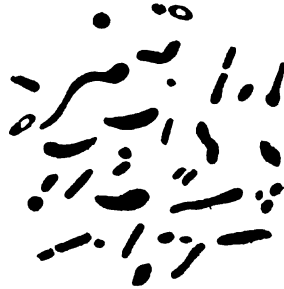

FIG. 232.—Plague bacillus. Involution forms. Agar cultures (6 days). 1186.

Staining methods.—The plague bacillus stains readily with the ordinary basic aniline dyes; carbol-violet or carbol-thionin can be recommended. It is gram-negative.

When stained with weak dyes the ends of the organism stain more deeply than the centre, so that the bacillus often presents the appearance of a shuttle.

[To obtain good polar-stained bacilli fix the film by heat, float the cover-glass on to the staining bath (fuchsin 1 per cent., carbolic acid 3 per cent., glycerin 40 per cent.), wash almost immediately in 60 per cent. alcohol, pass rapidly through water (Jordansky and Kladnitsky). Giemsa's and Romanowsky's stains also give very good results.]

2. Cultural characteristics.

1. Conditions of growth.—The plague bacillus is an aerobic organism. It grows easily on the ordinary, slightly alkaline, media. Growth begins about +5° C., is rapid at 20° C. but best at 30°-38° C.

2. Characters of growth on culture media. (a) **Broth.**—The growth of the plague bacillus in broth is similar to that of some streptococci: the medium is clear while minute flakes adhere to the walls and subsequently fall to the bottom of the tube. Occasionally a pellicle is formed on the surface. Sometimes—and especially when the broth is sown from a previous broth culture—a more or less marked turbidity occurs.

The best medium, according to Yersin, consists of an alkaline solution of peptone (2 per cent.) containing 1 to 2 per cent. of gelatin.

In broth culture the bacillus will, under suitable conditions, give rise to *stalactites* (p. 473).

[To obtain good stalactites in a plague culture the Advisory Committee point out that the first essential is an absolute lack of vibration of the shelf on which the flask stands. The addition of oil is an advantage but not an essential. A neutral broth was used and in a typical stalactite growth the

broth remained clear. "A highly characteristic appearance is obtained when 1 c.c. of blood containing say 10 to 100 bacilli per c.c. is inoculated into a 100 c.c. flask of neutral broth. The plasma forms a soft clot dispersed throughout the broth and if the flask be kept undisturbed each bacillus ultimately gives rise to a tack-like growth enclosed in a similarly shaped cavity." In some cases, with a virulent culture the broth was somewhat turbid.]



FIG. 233.—Plague bacillus. Surface growth on agar sown with material from a bubo (2 days).

(b) **Gelatin.**—The plague bacillus does not liquefy gelatin. Isolated colonies appear in 2–4 days: they are rounded, granular, and yellowish and are occasionally surrounded by a transparent ring with irregular margins. In stab culture a yellowish, semi-transparent growth forms on the surface while a whitish streak marks the line of the stab.

(c) **Agar. Glycerin-agar. Serum.**—When a scraping from a bubo is sown on any of these media the plague bacillus grows in the form of transparent white colonies, iridescent at the margins when examined by reflected light. When sub-cultured, a milky-white slimy layer forms in 24 hours.

[The growth of the plague bacillus on agar is very like that of the *Pasteurella* group (Chap XXVIII.) and it is only by further cultivation and inoculation experiments that it can with certainty be distinguished from the latter bacillus.]

(d) **Milk.**—The growth is poor and the medium is not coagulated.

(e) **Potato.**—The growth is slow and minimal in amount, consisting of a whitish or yellowish streak.

SECTION III.—BIOLOGICAL PROPERTIES.

1. Viability and virulence.

In culture, the plague bacillus is a delicate organism. A temperature of 58° C. for an hour or of 100° C. for a minute is sufficient to sterilize the growth; similarly, exposure to sunlight for 3–4 hours and weak antiseptic solutions are equally bactericidal.

In dried pus, the organism is more resistant and may retain both its vitality and virulence for several weeks.

In soil the bacillus remains alive for several months; its virulence under such conditions becomes lowered, but can be restored. According to Yokoté, putrefaction destroys the plague bacillus in dead bodies in 15–30 days (p. 463).

[The Advisory Committee showed that floors of cow-dung grossly contaminated with *B. pestis* remain infective for 48 hours while floors of chunam (a mixture of sand and lime put down moist and allowed to set) do not remain infective even for 24 hours (the infectivity in both cases was tested by rubbing scrapings into susceptible animals).]

The virulence of the organism diminishes rapidly in artificial culture. Scrapings of buboes sown on agar yield colonies varying in virulence (Yersin): the larger are only slightly virulent and grow so much more rapidly than the virulent colonies that the latter soon become crowded out with the result that subsequent sub-cultures rapidly lose their virulence. (It has already been pointed out that it is possible to raise the virulence of an attenuated bacillus.)

[The virulence of *Bacillus pestis* for the rat is unaltered (neither increased nor diminished) when passed through a large number of animals in succession.

The Advisory Committee found that twenty-six passages from rat to rat (*M. rattus* and *M. decumanus*), by sub-cutaneous inoculation without intermediate culture, occupying in all 89 days, had no effect on the virulence of the organism. Similarly its virulence was unaltered by passage through rats by cutaneous inoculation without intermediate culture. These experiments, however, demonstrated a varying susceptibility of the Bombay rat to plague.]

2. Bio-chemical reactions.

[Media containing carbohydrates: The plague bacillus produces acid but no gas in glucose, lævulose, galactose, maltose, mannite and dextrin while in lactose, saccharose, raffinose, sorbite, adonit, inulin, and dulcitol no acid is formed (MacConkey and others).

[The plague bacillus produces no change of colour in litmus milk.

[In media containing sodium taurocholate the plague bacillus grows well.]

3. Toxin.

Filtered cultures of the plague bacillus are only slightly toxic (Yersin; Calmette and Borrel). Markl showed that the toxin was adherent to the bodies of the bacilli, so that in order to obtain it cultures several weeks old [in which the toxin had diffused into the medium] had to be used.

Roux prepared a very toxic product from a bacillus which had been increased in virulence by growing it in collodion sacs in the peritoneal cavities of guinea-pigs. This bacillus when grown in 0.5 per cent. gelatin-broth yielded a toxin which killed mice in less than 12 hours when inoculated in quantities of 0.014 c.c., but which had very little effect on rabbits and guinea-pigs. Cultures grown in this way were macerated under toluol for several weeks then filtered through paper and precipitated with ammonium sulphate; by these means a powder was obtained of which the fatal dose for a mouse was 0.25 mg.

Plague toxin is a very unstable substance. Its toxicity is diminished by exposure to a temperature of 70° C. and is rapidly destroyed by light and air.

Besredka isolated a plague endotoxin by using a method similar to that adopted by him for the preparation of typhoid endotoxin. The bacilli are dried and triturated with salt, water is then added and the mixture allowed to macerate for 12 hours. After centrifuging, the supernatant liquid contains the endotoxin. The latter is thermolabile and is fatal to mice in doses of 0.006 c.c.

[Rowland's toxin.—Washing living plague bacilli with chloroform water while killing the cell removes a certain amount of a nucleo-protein (substance A) but only traces of the substances which are toxic and immunizing for rats. Organisms which have been thus treated are toxic and possess immunizing power for rats. By appropriate treatment (*vide infra*) a further nucleo-protein (substance B) can be dissolved out which is more toxic and more highly immunizing for rats than substance A and moreover bacilli from which this substance has been removed are no longer toxic or immunizing for these animals.

[Preparation.—The bacillus is grown on a neutral lemco-peptone-agar in Roux flasks, incubated at 32° C. for 4 days and after being sterilized with chloroform vapour the growth is emulsified in 10 c.c. dilute saline solution. The emulsion is centrifuged and the deposit re-emulsified in salt solution, filtered through fine linen and again centrifuged. This second deposit is pounded in a mortar with anhydrous sulphate of soda until a dry powder is obtained. The powder is left in the ice-chest overnight, then warmed to 37° C., well stirred and replaced in the ice-chest. The freezing and thawing is repeated several times. Water is then added to make

a saturated solution at 37° C. The bacterial bodies are filtered off through hardened paper at 37° C and suspended in water. This suspension constitutes solution B.

[The lethal dose for rats is an amount of solution corresponding to about 0·1 mg. of contained nucleo-protein. Heating to 55° C. lowers its toxicity.]

4. Vaccination.

A. Animals.

(i) **With toxins.**—(a) The inoculation of even highly active toxins does not result in the production of an absolute and lasting immunity and does not lead to the formation of an anti-plague serum (Roux ; Yersin ; Calmette and Borrel).

[(b) A single injection of even minute quantities (0·02–0·0001 mg.) of Rowland's toxin confers a substantial immunity upon rats.]

(ii) **With dead cultures.**—Inoculation with bacilli killed by heat gives better results. Yersin, and Calmette and Borrel scraped the growth from a 48-hour old culture on agar, mixed it with a little broth, put the mixture into tubes, sealed them and heated them to 58° C. for 1 hour, and in this way obtained a product which killed rabbits when inoculated in large doses into the veins or into the peritoneum. If, however, one or two inoculations of sub-lethal doses were given into the veins or peritoneal cavity the animal was protected against the subsequent sub-cutaneous inoculation of a living virulent bacillus, provided that at the time of the test inoculation the animal had completely recovered from the effects of the vaccine.

Rabbits can also be immunized by sub-cutaneous inoculation of heated cultures but the method requires time : as a rule it is necessary to give three or four inoculations at intervals of a fortnight.

The guinea-pig is not so readily immunized by this method.

(iii) **With living cultures.**—Horses are difficult to immunize. The inoculation of bacilli killed by heat produces little reaction and is very slow in its results : the most efficient method is to inoculate into the veins first heated cultures, then progressively increasing doses of living bacilli (Roux). The method of immunizing horses for the supply of therapeutic serum actually in use at the Pasteur Institute, Paris, is described later (*vide* Serum therapy).

B. Man.

(i) **With dead cultures.**—Haffkine was the first to prepare a vaccine for human prophylaxis by killing virulent cultures by heat at 60° C.

The bacillus was sown in large flasks half-filled with a special broth (a maceration of goat meat peptonized with hydrochloric acid and neutralized) or ordinary broth, the surface of the latter being covered with a thin layer of sterilized oil to obtain a growth of stalactites (p. 473). The flasks were incubated [in large rooms] at 27°–30° C. [the average temperature in Bombay] for 2 months, being shaken from time to time in order to break up the stalactites. After verifying the purity of the culture the contents were distributed into tubes which were sealed and heated at 60° C. for a quarter of an hour ; a little carbolic acid (0·5 per cent.) was subsequently added. The vaccine was used 2 months after preparation.

For purposes of human vaccination 5 c.c. of the vaccine are inoculated beneath the skin of the arm in the neighbourhood of the insertion of the deltoid. (Inoculation in the region of the shoulder or of the abdomen is less painful.) A few hours later a painful swelling occurs around the site of inoculation accompanied by a rise of temperature (38° C.) and a slight swelling of the glands ; the temperature is again normal in about 36 hours and the symptoms have disappeared. Immunity is established as soon as the temperature falls. The vaccine exerts no prophylactic properties during the

period of reaction following inoculation and if the patient is in the incubation period of the disease, the latter runs its ordinary course, though it would appear that under such conditions the vaccine may have some favourable influence on it. The immunity lasts for one year at least (Haffkine), and it would appear to be more efficient and to last longer in Europeans than in Hindus. Haffkine has inoculated some hundreds of thousands of individuals with his vaccine.

Jatta and Maggiora prepare a vaccine similar to that of Haffkine. Plague bacilli are grown in very shallow layers of broth for 4 days: the culture is then heated to 65° C. and carbolic acid added. The dose is 1 c.c.

Gosio grows the bacillus in a shallow layer of broth. The growth is precipitated with a powerfully agglutinating serum, collected, made into an emulsion and sterilized by heating at 65° C. for an hour. (To ensure the sterility of the vaccine a little is sown in broth containing potassium tellurate (1 part in 100,000); if the vaccine be sterile the appearance of the broth remains unchanged, if on the other hand blackish flakes appear in it then the sterilization is imperfect.) Each c.c. of culture yields about 1 mg. of vaccine of which the vaccinating dose for an adult man is 2-3 mg. (2-3 c.c. of emulsion). In this vaccine the antiserum merely plays a mechanical part in precipitating the bacilli; its antitoxic properties are destroyed at the temperature (65° C.) at which the vaccine is sterilized.

The German Plague Commission (Gaffky, Pfeiffer, Sticker and Dieudonné) proved the superior efficacy of vaccines prepared from cultures on solid media.

The bacillus is sown on agar in Roux bottles, and incubated for 3 days and the growth scraped off. The emulsion is then heated for three-quarters of an hour at 65° C., and sufficient sterile normal saline solution added to make the total volume up to 200 c.c. for the growth from each bottle. The emulsion is distributed into tubes, sealed and heated a second time to ensure its sterility. One c.c. contains about 2.5 mg. of bacilli.

The German vaccine has been used for the inoculation of 200,000 Japanese. A similar vaccine, prepared at the Manguinhos Institute, Rio de Janeiro, has proved of considerable value in Brazil.

(ii) **With living attenuated cultures.**—In some old agar cultures of the plague bacillus, Yersin and Carré found a number of colonies of an attenuated bacillus (Race 6) which only proved fatal to 20 per cent. of rats inoculated and in the other cases afforded immunity. Yersin inoculated himself with this attenuated virus and merely suffered from a slight febrile attack.

Kolle and Otto proposed to use as a vaccine a bacillus of low virulence attenuated by growing it at 40°-41° C. This virus is not fatal to guinea-pigs when inoculated in quantities of two loopsful sub-cutaneously, and produces an immunity lasting several months in guinea-pigs and rats. On these data, Strong has shown that any plague bacillus which does not kill guinea-pigs (250 grams) when a whole agar tube culture is inoculated sub-cutaneously can be used as a vaccine, and he has inoculated 200 persons in the Philippines each with a tube of such a culture without producing any disturbance of health.

(iii) **With heated exudates.**—Terni and Bandi use the heated peritoneal exudate of a plague-infected guinea-pig as a vaccine. This method of vaccination is said to give a high degree of immunity in a short space of time and to produce a merely insignificant reaction. It has up till now been little used in practice though a few hundred persons were inoculated at Rio de Janeiro.

A culture of a virulent plague bacillus is inoculated into the peritoneal cavity of a guinea-pig, and when the animal is *in extremis* it is killed. The peritoneal exudate is collected, and diluted with a little normal saline solution; the mixture is incubated for 12 hours at 37° C. and then heated at 50° C. for 2 hours on two consecutive days.

The exudate from one guinea-pig is made up to about 50 c.c. with the following solution :

| | | |
|-----------------------------------|------|-------|
| Water, - - - - - | 100 | c.c. |
| Sodium chloride, - - - - - | 0.70 | gram. |
| Sodium carbonate, - - - - - | 0.25 | " |
| Carbolic acid crystals, - - - - - | 0.50 | " |

The dose of vaccine for a man is 2-2.5 c.c.

(iv) **With bacillary extracts.**—(a) Lustig and Galeotti have introduced the use of bacterial extracts as a method of immunization against plague. The technique is complicated and the results do not show that the method has any advantage over the preceding: the immunity is of but short duration. Some 200 persons were inoculated at San Nicola de la Plata. Tavel of Berne has made some modifications in the technique.

In Lustig and Galeotti's method the bacilli are sown on agar plates and incubated for 3 days; the growth is then scraped off and allowed to macerate in a 1 per cent. solution of caustic potash for 24 hours. The solution is diluted, filtered and then precipitated with dilute acetic acid and the precipitate washed and finally dried *in vacuo*.

The precipitate consisting of nucleo-proteins is used for human vaccination in doses of 0.003 gram dissolved in a 0.5 per cent. solution of sodium carbonate. The inoculation is painful and is accompanied by a sharp reaction.

(v) **Sero-vaccination.**—With the various methods of vaccination described above there is a delay of a few days before the person inoculated becomes immune, and in some cases the person so inoculated is more susceptible during that time to the plague bacillus: in other words, a negative phase follows vaccination. To overcome this difficulty Calmette and Salimbeni devised a method of sero-vaccination. Either a mixture of vaccine and antiplague serum is inoculated, or a dose of serum (5 c.c.) followed 2 days later by a dose (2-3 c.c.) of Haffkine's vaccine. In this way not only is the person immunized at once but the reaction following the inoculation is less marked. On the other hand, unfortunately, the immunity is only short-lived and the results "are not much better than those obtained by the use of serum alone" (Besredka).

To prepare the vaccine the bacillus is sown on agar in Roux bottles and incubated for 48 hours. The growth is then scraped off, mixed with normal saline solution, and the emulsion filtered through filter paper. The organisms retained on the filter are made into an emulsion with a little normal saline solution, heated at 70° C. for an hour, and dried *in vacuo*. The product mixed with antiplague serum constitutes the vaccine.

Shiga prepares a vaccine in the following manner :

Agar cultures three days old are scraped off, made into an emulsion with normal saline solution (1 c.c. for each loopful of growth), heated at 60° C. for half an hour and carbolic acid added in the proportion of 0.5 per cent. Just before use, equal parts of the emulsion and antiplague serum are mixed and inoculated in doses of 0.6-1 c.c. for a man: a few days later an inoculation of emulsion without serum is administered. This sero-vaccine has been used in Japan.

Besredka's vaccine.—Besredka attributed the poor results obtained by Calmette's method to the presence of an excess of serum in the mixture. By reducing the amount of serum to a minimum this observer was able to induce a rapid, powerful and lasting immunity in animals (p. 382).

Bacilli from a two-day-old culture on agar are made into an emulsion with a very little normal saline solution, heated at 60° C. for an hour and then mixed with antiplague serum. At the end of 24 hours the bacilli after being washed repeatedly to remove all traces of free serum are made into an emulsion with normal saline solution, distributed into tubes, sealed and then heated again for an hour at 54° C. to ensure sterility. The vaccine is now ready for use.

The vaccine has no toxic properties and gives rise to no symptoms in mice and guinea-pigs. Inoculated mice are immune in 48 hours and the immunity has been shown to last for five months and a half.

For man the dose is the amount of emulsion corresponding to 5 mg. of dead bacilli. The vaccine has been used in clinical practice in Peru and Mexico.

5. Serum therapy.

The serum of persons who have recovered from plague has slight prophylactic and curative properties (Métin).

Similarly, the serum of rabbits immunized against the bacillus also shows therapeutic and prophylactic properties. A rabbit, for instance, can be protected against an experimental infection with a virulent virus by the inoculation of 3 c.c. of such serum sub-cutaneously, and in a rabbit which has already been infected the disease can be arrested and the animal cured by the administration of the same dose of serum—provided that the latter be treated within 12 hours of the infecting inoculation.

Yersin's serum.—The serum of horses immunized by Roux's method (*vide ante*) and collected 3 weeks after the last inoculation exhibits immunizing, therapeutic and antitoxic properties.

(a) **Preparation of the serum.** Method adopted at the Pasteur Institute in Paris.—The bacillus used is a fully virulent bacillus of human origin kept virulent by frequent passage through guinea-pigs and rats. The bacillus is sown on agar in Roux bottles and incubated for 3 days, the growth is then scraped off, made into an emulsion with normal saline solution and filtered through absorbent wool. The homogeneous filtrate is heated at 65° C. for 1 hour.

The first inoculation consisting of a small quantity of heated emulsion (about $\frac{1}{8}$ th of a bottle culture or $\frac{1}{4}$ th of a tube culture) is given into the jugular vein of the horse. The horse reacts sharply and has a marked rise of temperature during the next 48 hours. Sometimes the inoculation is followed immediately by severe syncope attacks from which the animal may die.

A second inoculation is given a fortnight later and after that the inoculations are repeated at intervals of a week, the amount of material inoculated being progressively increased until a whole bottle culture is administered at one inoculation. When the serum exhibits immunizing properties heated cultures are superseded by living hyper-virulent bacilli, the initial dose being about $\frac{1}{16}$ th of a bottle culture. The animals lose a good deal of weight during immunization and the inoculations must not be pressed unduly. Immunization occupies some 6–8 months and the horse is not bled until 10 days or a fortnight after the last inoculation. The immunity is maintained by administering in the intervals between bleeding two inoculations of one-half and a whole bottle of culture respectively at an interval of a week. Before leaving the Institute the serum is heated on three separate occasions at 54° C. to diminish its toxic properties.

(b) **Properties of the serum.**—Yersin's antiplague serum exhibits immunizing and therapeutic properties. If injected previously to an experimental inoculation the development of the disease in susceptible animals is prevented. If given after an infecting inoculation the course of the disease is interrupted: the longer the time which is allowed to elapse between infection and the administration of serum, the larger must be the dose of serum and the smaller are the chances of recovery. In guinea-pigs infected through a shaved area of skin the serum has no therapeutic properties even though administered one hour after the infection. The Pasteur Institute serum cures mice infected by the bite of an insect if inoculated in doses of 0.1 c.c. sixteen hours after infection. The immunity following the inoculation of serum lasts but a very short time, some ten days or so.

(c) **Human serum therapy.**—The efficacy of antiplague serum in the treatment of plague in the human subject is shown by the experience of Yersin, Calmette and Salimbeni, Métin and others.

(i) **Prophylaxis.**—The inoculation of 10 c.c. of the serum prepared at the Pasteur Institute affords immunity to the disease at once, but the immunity only lasts about

ten days which is a great disadvantage in practice, so that in the majority of cases it is necessary to resort to vaccines (*vide ante*).

(ii) *Curative*.—In treating cases of plague the inoculation of serum should be repeated at intervals, the total volume to be administered being from 200 to 400 c.c. It may be inoculated beneath the skin, but intra-venous inoculation gives far better results. As with all other serums, the sooner it is used the better the chance the patient has of recovering. The longer the administration is delayed the larger must be the initial dose of serum given. Generally speaking it is sufficient to inoculate 40–60 c.c. as soon as possible into a vein and to give two further doses (sub-cutaneously of 20–40 c.c. each time) within the next 24 hours. Daily inoculations of 10–40 c.c. should also be given sub-cutaneously until the temperature has fallen to normal. In severe cases Penna obtained good results by giving at the outset 100 c.c. in the veins followed by a daily inoculation into the veins of 60–100 c.c. This method is to be strongly recommended, many of the failures recorded being due simply to the fact that the serum has been used in too small doses and has been given exclusively beneath the skin. It is important also not to stop the administration of serum suddenly when the fever has subsided but to continue its use for several days in gradually diminishing doses.

[(b) Rowland prepares a serum which when tested on rats exhibits immunizing, antitoxic and curative properties.

[A horse is inoculated on several successive occasions with Rowland's "solution B" prepared as above (*vide* Toxins). The immunizing process lasted over a period of 6 months. The initial dose administered was 0.01 mg. and the final dose 240 mg. The horse was bled twenty-one days after the last inoculation. The local reaction following inoculation was very similar to that following the inoculation of diphtheria toxin: a varying amount of swelling and oedema with transitory constitutional disturbance and a little temperature reaction. There was no tendency to abscess formation or to the huge hard swellings which not infrequently supervene upon the inoculation of unfiltered cultures.

[The serum neutralizes the toxin in the immunizing solution; 1.25 c.c. of serum neutralize 100 lethal doses of toxin for the rat. A serum prepared by Yersin's method has no antitoxic action on the toxin.

[In doses of 0.1 c.c. the serum protects rats against a subsequent inoculation of the standard test dose of virulent culture given the following day.

[Administered in doses of 0.5 c.c. sub-cutaneously six hours after inoculation of a living plague culture and on the opposite side of the body to the latter the death rate among rats was reduced from 80 per cent. to 18 per cent. and in those cases in which the treated rats died the length of life was prolonged from three to five days to ten days. In a comparative experiment with Yersin's serum two rats only out of ten survived while of the ten treated with Rowland's serum all survived and the ten controls which received no serum at all died.]

6. Agglutination.

Plague serum (in dilutions of 1 in 50 to 1 in 500) agglutinates broth cultures of the plague bacillus. The degree of agglutinability of the plague bacillus depends upon the consistency of the culture and not on its virulence (Shibayama).

The agglutination of the bacillus by the blood of persons suffering from plague is feeble and inconstant. In most cases it can only be effected with dilutions of 1 in 5 or 1 in 20; rarely it may be observed in a dilution of 1 in 40. The agglutinating property, which hardly ever appears before the end of the first week of the disease, is most marked in the blood of convalescents and cannot therefore be of any great help in the diagnosis of plague (Zabolotay and Cairus) though it may be useful in diagnosing cases unrecognized in the early stages of the disease.

7. Precipitins.

[The addition of plague serum to a filtrate of the plague bacillus produces first a cloudiness then an abundant precipitate which settles to the bottom of the tube leaving the supernatant liquid clear.]

[A filtrate of the *B. pseudo-tuberculosis rodentium* added to plague serum gives a similar but less abundant precipitate and the fluid takes much longer to clear.]

SECTION IV.—THE ISOLATION AND IDENTIFICATION OF THE BACILLUS.—POST MORTEM APPEARANCES IN NATURALLY INFECTED RATS.

In the living subject the pus of the buboes,¹ the juice of the lymphatic glands, the blood (obtained by pricking the finger or lobe of the ear), sputum, [urine,] and the fluid in the petechiæ must be examined for the presence of the bacillus.

Even when there is an absence of buboes, the bacillus is present in the lymphatic glands: in such cases, remove a gland and examine it as detailed below.

In the dead body the spleen, lungs, kidneys, etc. should be examined.

The technique of identification of the bacillus is as follows:

1. **Microscopical examination.**—Prepare films on slides, fix in alcohol-ether, stain with carbol-thionin or carbol-violet. Stain other films by Gram's method—the plague bacillus is gram-negative.

[Microscopical examination alone cannot be relied upon for the recognition of the plague bacillus: the *B. pseudo-tuberculosis rodentium*, organisms of the pasteurilla and often of the salmonella group are indistinguishable from the plague bacillus under the microscope.]

2. **Cultures.**—Sow the gland pulp or scrapings from the viscera on agar and incubate at 37° C.

[To examine the blood collect 2 c.c. of blood by means of a sterile syringe from a suitable vein at the bend of the elbow (p. 193) and distribute in small quantities on a series of agar slopes.]

Haffkine has described an ingenious and rapid method for the identification of cultures of the plague bacillus. The method consists in sowing the suspected material in broth on the surface of which a layer of sterilized butter or oil has been poured (p. 468). Under these conditions the plague bacillus gives origin to **stalactitic forms of growth** suspended from the lower surface of the oil. [This appearance is seen with only a few other organisms, namely: the bacilli of the hæmorrhagic septicæmia group, but these happen to be just the organisms which are likely to be confounded with the plague bacillus. The formation of stalactites in broth culture cannot therefore alone be accepted as a sufficient diagnostic feature.]

3. **Inoculation experiments.**—Inoculate a loopful of growth from an agar culture beneath the skin of a mouse or guinea-pig or into the nasal fossæ of a guinea-pig. If the culture be a growth of the plague bacillus the animal will die in 2–5 days and the organism can be recovered from the blood, spleen, etc.

When dealing with material containing many adventitious organisms, such as stools, decomposing carcasses etc., it is best to rub a little of the suspected material into a previously shaved area of skin of a guinea-pig (p. 463).

[In examining urine for the presence of the plague bacillus, the Advisory Committee adopted both the cutaneous and the sub-cutaneous inoculation methods, and obtained better results than previous observers who had relied mainly on cultivation methods.]

¹In bubonic pus the plague bacillus is occasionally associated with staphylococci, the colon bacillus, etc. In suppurating buboes the specific bacillus may have disappeared.

[4. **Differential diagnosis.**—The differential diagnosis of the plague bacillus from the organisms most likely to be mistaken for it, viz. : *B. pseudo-tuberculosis rodentium*, the bacilli of the hæmorrhagic septicæmia group, and the bacilli of the salmonella group, will depend upon the following observations.

[1. The inoculation of a *white* rat will exclude the *B. pseudo-tuberculosis rodentium* which is non-pathogenic to white rats but gives identical fermentation reactions.

[2. The characteristics of the growth in media containing taurocholate of sodium will differentiate the hæmorrhagic septicæmia group: the plague bacillus grows well on such media while the growth of the latter group of organisms is inhibited.

[3. The characteristics of the growth on agar and in broth (absence of stalactites) and the fermentation reactions will distinguish the plague bacillus from the bacilli of the salmonella group.]

Post-mortem appearances in rats naturally infected with Plague.¹

The diagnosis of spontaneous plague in the rat is a matter of much interest [and the following is a brief account of the appearances seen *post mortem*]:

[Sub-cutaneous congestion is not infrequently a marked feature: it may be general but in some cases is limited to the neighbourhood of the bubo. Sub-cutaneous hæmorrhages occur in about 40 per cent. of rats and are most frequently to be seen in the sub-maxillary region. Buboes are present in the majority of cases but may be absent (15 per cent.); when present they occur in the majority of cases in a single situation and most commonly in the neck. The liver may show necrotic changes which have the appearance of an excessive deposit of fat, and a condition of the greatest importance in diagnosis is the occurrence of small necrotic foci scattered over its surface and throughout its substance. The spleen is firm and does not collapse like a soft normal spleen; granules or nodules may be well-marked in it and may be confluent. The kidneys and supra-renal capsules are often congested. Hæmorrhages are fairly common in the lungs and visceral pleuræ. The presence of pleural effusion is very characteristic and of great value in diagnosis.

[In naturally infected plague rats the most important features for purposes of diagnosis are:

1. A typical bubo—most commonly in the neck.
2. Granular liver—not seen except in plague rats.
3. Hæmorrhages beneath the skin and in the internal organs are very suggestive.
4. Pleural effusion.

In putrid rats, bubo, granular liver and pleural effusion may persist and are of great significance.]

A microscopical examination of scrapings of buboes and spleen and inoculation tests will clinch the diagnosis.

[¹ This account is abstracted from the Reports of the Advisory Committee, *Journal of Hygiene*, vii. p. 324 *et seq.*]

CHAPTER XXX.

MICROCOCCLUS MELITENSIS.¹

Introduction.

Section I.—Experimental inoculation, p. 476.

Man, p. 476. Animals, p. 476.

Section II.—Morphology, p. 476.

1. Microscopical appearance and staining reactions, p. 476. 2. Cultural characteristics, p. 476.

Section III.—Biological properties, p. 477.

1. Vitality, p. 477. 2. Biochemical reactions, p. 477. 3. Toxins, p. 477. 4. Immunity, p. 477. Vaccination, p. 477. 5. Agglutination, p. 478. 6. Immune body, p. 478.

Section IV.—Detection, isolation and identification of the organism, p. 478.

BRUCE gave the name Mediterranean fever to a disease which is very common in Malta, and which had been mistaken for enteric fever or malaria until he showed that it is a specific disease due to a specific micro-organism, the *Micrococcus melitensis*.

Mediterranean fever (Malta fever, undulant fever) occurs along the whole of the Mediterranean littoral, in India, China, England, France, and other countries. [Sir David Bruce has recently recorded an interesting and localized epidemic in Central Africa to which the inhabitants had given the name Muhinyo.]

In patients who have died of the disease the organism is found in pure culture in the liver, spleen and kidneys. During life it can easily be obtained by puncturing the spleen of infected persons, and it is generally present in the urine in the acute stage of the disease and during convalescence (Durham). It only occurs in the blood in small numbers and then mainly during the febrile attack.

In the great majority of cases infection takes place through drinking infected goats' milk (Bruce). In Malta, goats are frequently infected with the micrococcus and eliminate the organism in their milk; according to Horrocks and Kennedy this is normally the case with 10 per cent. of the Maltese goats. Direct contact with the sick is also a source of infection and those who nurse them frequently become infected (Manson): handling infected milk and urine is particularly dangerous especially if there be an

[¹ Though generally described as a coccus it has been decided to place this organism among the gram-negative bacilli on account of the many affinities which it has with the gram-negative bacilli of the typhoid-colon group and the absence of affinities with the other gram-negative cocci.]

[For further information the reader is referred to the Reports of the Commission for the investigation of Mediterranean fever (Harrison & Sons) and to Eyre's Milroy Lectures, 1908.]

abrasion on the skin (Shaw). It is possible that infection may also take place through dust contaminated with the coccus settling on the nasal or ocular mucous membrane (Shaw) (*vide infra* experimental inoculation). Zammitt has suggested that mosquitoes may act as carriers of the infection.

SECTION I.—EXPERIMENTAL INOCULATION.

Man.—Intentional or accidental infection of men with cultures of the *Micrococcus melitensis* has several times been followed after an incubation period of five days to a fortnight by a typical attack of Mediterranean fever.

Animals.—Monkeys and goats are highly susceptible to the disease.

After sub-cutaneous inoculation of a small quantity of an agar culture rubbed up in a few drops of sterile water monkeys suffer from a disease very similar to that in man.

At the close of an incubation period of 2–5 days the temperature rises 2° or 3° C. and is frequently of a daily remittent character; a period of apyrexia lasting a few days followed by a second rise of temperature often intervenes during the course of the disease. The serum agglutinates the coccus after about the fifth day in dilutions of 1 in 100 to 1 in 1000. The disease may last several months and ultimately end in recovery, but as a rule the animal dies about the end of the second week. *Post mortem*, the liver and spleen are swollen and yield pure cultures of the micrococcus. There are never any lesions in the Peyer's patches.

By means of feeding experiments Horrocks and Kennedy infected monkeys and goats, and Shaw produced the disease in monkeys by smearing the nasal and ocular mucous membranes with cultures and infected dust.

Dogs, horses, asses and mules are also susceptible to infection with the micrococcus.

Rabbits, guinea-pigs, rats and mice are more immune than the preceding. Durham and Eyre produced a fatal result in these animals by inoculating them intra-cerebrally, and the virulence of the organism is found to be rapidly increased by intra-cerebral passage through rabbits or guinea-pigs. Carbone produced a fatal result in rabbits by intra-venous, and in guinea-pigs by intra-peritoneal inoculation; the guinea-pigs suffered from a purulent inflammation of the *tunica vaginalis* accompanied by atrophy of the testes.

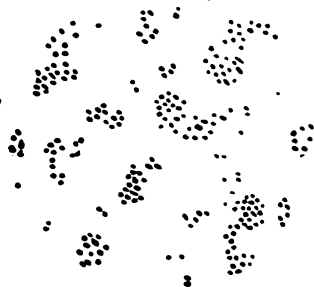

FIG. 234. — *Micrococcus melitensis*. Film from an agar culture (24 hours). Carbol-thionin. (Oc. II, obj. A₁₃h, Reich.)

SECTION II.—MORPHOLOGY.

1. Microscopical appearance.

The *Micrococcus melitensis* is a rounded or slightly oval bacterium, measuring about 0.3 μ in diameter; elongated forms are occasionally seen in cultures. The organisms generally occur singly or as diplococci but may also form very short chains. The coccus is regarded as non-motile, though Pollaci affirms that it is motile and that it has a single flagellum which

however is very difficult to stain. Gordon claims to have demonstrated one to four flagella.

Staining reactions.—The coccus stains readily with the ordinary dyes and is gram-negative.

2. Cultural characteristics.

Conditions of growth.—The *Micrococcus melitensis* is an aerobic organism. The optimum temperature of growth is 37° C.: at 22° C. the growth is

insignificant. The best medium for cultivation is 5 per cent. glycerin-agar but even under the most favourable conditions growth is always scanty.

Broth.—Cultivation of the micrococcus in broth gives rise, after incubating for three days at 37° C., to an uniform cloudiness in the medium without any surface pellicle.

Agar. Stab culture.—Small spherical colonies develop along the line of sowing and these may ultimately unite together to form a yellowish streak with denticulated edges.

Stroke culture.—Very small transparent colonies measuring 2–3 mm. in diameter are visible about the third day: on further incubation they become raised, smooth, shiny and milky-white in appearance.

On glycerin-agar and glucose-nutrose-agar the growth is more rapid and more abundant.

Gelatin.—At 22° C. the amount of growth is *nil* or insignificant. The medium is not liquefied.

Potato.—No apparent growth takes place on potato.

Milk.—The reaction becomes alkaline. The milk is not coagulated.

SECTION III.—BIOLOGICAL PROPERTIES.

1. Vitality.

Cultures of the micrococcus will keep alive for a long time in the laboratory; Shaw was able to obtain sub-cultures from a broth culture 5 months old and also from a nine-months old growth on a dried-up tube of agar.

In sterilized earth the organism lives at least 69 days (Horrocks) and in cloth eighty days. In water and in moist soil it does not seem to live so long; Horrocks could not recover the organism from sterile water after a week but Shaw in a similar experiment recovered it after 50 days.

Cultures can be sterilized by heating them at 60° or 65° C. for half an hour.

2. Bio-chemical reactions.

The *Micrococcus melitensis* does not ferment sugars and produces no indol.

3. Toxin.

The toxin of the *Micrococcus melitensis* was studied by Shaw.

In monkeys the inoculation of porcelain-filtered broth cultures only produces a negligible reaction. The blood of the inoculated monkeys exhibits feeble agglutinating properties (1 in 80).

Inoculation of cultures heated to 60° or 70° C. for half an hour produces hardly any more reaction, but the serum of the inoculated animal has more marked agglutinating properties (up to 1 in 500).

4. Immunity. Vaccination.

Bruce has shown that an attack of Mediterranean fever renders the patient immune to subsequent infection, but that the immunity is not absolute. In monkeys which had recovered from one attack of the experimentally induced disease, a second mild attack unaccompanied by bacillæmia was produced by inoculating them a second time (Shaw).

Animals easily resist the inoculation of large quantities of killed cultures, but this does not produce any immunity against the living organism, since the subsequent inoculation of a small dose of a living culture almost certainly kills them (Eyre). Shaw, however, after giving monkeys several sub-

cutaneous inoculations of heated agar cultures found that he could then inoculate them with virulent cultures without producing a typical attack of Mediterranean fever; but one of these monkeys showed no immunity to a second test inoculation.

By repeatedly inoculating horses and goats sub-cutaneously with living cultures Shaw and Eyre obtained powerfully agglutinating serums (1 in 3000 and 1 in 5000). These serums have no therapeutic properties when tested on man and animals. In a case of laboratory infection in man Nicolle found that recovery coincided with the inoculation of 10 c.c. of serum from an hyper-immunized ass.

Bassett-Smith attempted the treatment of Mediterranean fever with a vaccine prepared by heating emulsions of ten-day old agar cultures in distilled water for half an hour to 60° C. The dose of vaccine used was 0.5-1 c.c. In acute cases the inoculation aggravated the symptoms but in chronic cases it appeared to stimulate the destruction of the micro-organisms and certainly shortened the duration of the disease.

5. Agglutination.

Wright, Birt and Lamb have shown that the serum of persons suffering from Mediterranean fever, like the serum of immunized animals, agglutinates the micrococcus.

Generally speaking the agglutination reaction is poorly developed in the blood of patients (1 in 15 to 1 in 50), though Lamb and Kesava have obtained agglutination in dilutions of 1 in 160 and even 1 in 280. For purposes of clinical diagnosis the reaction of a 1 in 10 or 1 in 15 dilution of the serum should be determined and if this gives a positive result higher dilutions may be tested. The agglutination reaction always appears at the end of the first week of the disease, and may still be present years after recovery. In artificially infected monkeys Birt and Lamb have found it present as early as the fifth day.

The blood and the milk of infected goats agglutinate the coccus.

For carrying out the agglutination reaction Nicolle advises using broth emulsions of agar cultures 3-5 days old, and mixing the serum and emulsion in small straight tubes. The reaction can be observed with the naked eye.

Pollaci and Ceranlo have shown that blister fluid and the saliva of infected persons agglutinate the organism. (Dilute a loopful of an agar culture in 5-20 drops of filtered saliva: the agglutination can be seen under the microscope in 30-60 minutes.) The reaction with the saliva is said to be always present in persons suffering from Mediterranean fever and absent in healthy individuals.

6. Immune body.

Sicre has demonstrated the presence of an immune body in the blood of inoculated animals and of persons suffering from Mediterranean fever.

SECTION IV.—DETECTION, ISOLATION AND IDENTIFICATION OF THE ORGANISM.

Post mortem, the spleen, liver and kidneys should be examined for the *Micrococcus melitensis*. During life it may be recovered by puncture of the spleen (p. 198) or by sowing cultures with the blood, milk or urine.

Scrapings of the internal organs should be sown on ordinary or litmus-nutrose agar, incubated at 37° C. for about a week and then examined and tested.

The number of organisms in the blood is always small: it is best to examine the blood during the height of the fever and to sow at least 2-4 c.c. in 250 c.c. of broth. Pollaci recommends the addition of bile to the broth.

The identification of the micrococcus is based upon the following characteristics :—

1. Microscopically, a gram-negative, non-motile coccus.
2. The rapidity with which a trace of an agar culture breaks up in a drop of water.
3. Absence of fermentation in sugars, non-coagulation of milk, and an alkaline reaction in litmus milk.
4. Agglutination with a specific serum. The serum reaction (*vide ante*) will be found of much use in the diagnosis of Mediterranean fever.

CHAPTER XXXI.

BACILLUS MALLEI.¹

Introduction.

Section I.—Experimental inoculation, p. 480.

Section II.—Morphology, p. 482.

Section III.—Biological properties, p. 484.

1. Vitality and virulence, p. 484. 2. Toxin; preparation of mallein; mallein in the diagnosis of glanders, p. 484. 3. Vaccination, p. 485. 4. Agglutination, p. 486.

Section IV.—Detection and isolation of the bacillus, p. 486.

THE bacillus of glanders was discovered independently by Loeffler and Schutz and by Bouchard, Capitan and Charrin.

Glanders is almost entirely restricted to the Solipedes though men having to do with horses occasionally contract the disease from infected animals, and a few cases are on record in which infection followed manipulation of cultures of the organism in the laboratory. The disease has also been noticed to occur spontaneously among the carnivora—lions and tigers—after these animals had been fed upon meat from glandered animals.

Two clinical types of the disease are recognized depending upon whether the lesions are more prominent in the skin—*farcy*—or in the internal organs—*glanders* proper. The latter is the more common type: it is characterized at the outset by infection of the nasal mucous membrane and related lymphatic glands, and later by lesions in the internal organs more especially in the lungs and in the genital organs: the disease may run either an acute or chronic course. In *farcy*, which also may assume an acute or a chronic form, the chief lesions are abscesses in the skin—the so-called *farcy buds*, which terminate in ulcers—accompanied by lymphangitis [*farcy pipes*] and occasionally orchitis.

Glanders must be carefully distinguished from *bovine farcy*, an entirely different disease, not transmissible to man and due to infection with a fungus of the genus *Discomyces* (Chap. XLVIII).

SECTION I.—EXPERIMENTAL INOCULATION.

Asses.—The ass is more susceptible to glanders than any other animal and inoculation is practically always followed by an acute attack of the disease though Arloing has recorded one instance in which a chronic form of the disease developed.

Experimentally infection is usually produced by rubbing infected material (pus or catarrhal discharge from the nose) into a few scarifications made on the skin of the forehead. An œdematous swelling rapidly appears followed by

¹ See footnote p. 245.

ulceration along the lines of the scratches ; the temperature rises to 40°–41° C., the neighbouring glands become enlarged, there is a discharge from the nose and the animal dies in a few days.

Post mortem there are nodules on the nasal and laryngo-tracheal mucous membranes and small infarcts in the lungs which on pressure exude drops of a thick very virulent pus. Similar infarcts may be found in the liver, kidneys, spleen and other internal organs.

Mules. Horses.—Cutaneous inoculation in these species is generally followed by a sub-acute or chronic attack of glanders. The temperature may be slightly raised or may remain normal ; there is a discharge from the nose and the glands in the neck become enlarged ; occasionally râles may be heard in the lungs and the animal may be short of breath. In some cases however there may be practically no symptoms for a long time. *Post mortem* examination reveals small grey tubercles in the lungs surrounded by a narrow zone of congestion. These tubercles consist of a fibrous shell containing a small drop of pus.

Guinea-pigs.—The guinea-pig is nearly as susceptible to glanders as the ass.

The inoculation of material containing only the glanders bacillus into the peritoneal cavity of a guinea-pig gives rise to very characteristic lesions (*vide post*), but if other organisms be present as well as the glanders bacillus the animal suffers from an ordinary peritonitis. When dealing with impure material therefore it is better first to isolate the organism in pure culture, which may be done as follows : inoculate a guinea-pig sub-cutaneously with the material : an abscess will form at the site of inoculation and the neighbouring glands will become enlarged. Excise one of these glands, grind it up in a mortar and inoculate the emulsion into the peritoneal cavity of a second guinea-pig.

Cutaneous and sub-cutaneous inoculation.—Cutaneous inoculation should be done on the back, and sub-cutaneous inoculation beneath the skin at the top of the thigh. In the former case an ulcer develops at the site of inoculation, and in the latter case a local abscess forms accompanied by lymphangitis and swelling of the neighbouring glands which may break down and form abscesses. The animal sickens and dies in 4–8 weeks.

It is characteristic of glanders that an enlargement of the testicle—a glanders *sarcocele*—often results after inoculation of a male guinea-pig : about the second week the testicles may have reached a considerable size ; the scrotum at first red and tender soon begins to ulcerate and small “chancres” are developed ; the tunica vaginalis is involved, in the early stages it becomes adherent to the testicle and is subsequently infiltrated with small miliary abscesses.

The lungs, liver, spleen and lymphatic glands are all more or less infiltrated with small miliary tubercles with purulent centres.

Intra-peritoneal inoculation.—A male animal should be selected for the purpose. The characteristic lesion then is the appearance of a glanders sarcocele after 2 or 3 days ; the animal generally dies during the second week after inoculation. When the inoculated virus is highly virulent (cultures, for example) or when the dose inoculated is large, death may take place in 2 or 3 days from septicæmia before any nodular lesions have had time to appear.

Mice.—*Field mice* are highly susceptible to glanders and succumb within a week of being inoculated. The internal organs, and particularly the spleen, are thickly covered with tubercles.

White mice on the other hand are more highly immune but succumb after the inoculation of a virus of increased virulence.

Léo succeeded in rendering white mice susceptible to glanders by feeding them on phloridzin. After being fed exclusively on biscuits soaked in an alcoholic

solution of phloridzin and dried, the mice became diabetic and then readily succumbed to an inoculation of the glanders bacillus.

Ground squirrels.—Ground squirrels are highly susceptible to glanders and succumb within a week, the bacillus being distributed throughout the internal organs. The virulence of the organism can be increased by passage through these animals (Gamaléia).

Cats.—Cats are susceptible to glanders. Cutaneous inoculation is followed by a "chancre," death taking place in 15–30 days. *Post mortem* the internal organs are seen to be sprinkled with glanders nodules.

Sheep. Goats.—Both sheep and goats can be readily infected experimentally.

Dogs.—Dogs are more or less immune. In young dogs only does the disease become generalized and prove rapidly fatal. Inoculation of adults of the species through superficial skin scratches is followed by a characteristic local lesion. If the inoculation be made on the skin of the forehead the part becomes oedematous in 3–5 days and ulcers are formed which exude a very virulent discharge. The ulcers extend for the first week or two then become stationary and finally cicatrize, the animal recovering completely. Nocard has however recorded fatal cases of the chronic form of the disease in dogs.

The natural immunity of the dog has been experimentally overcome in several different ways. Traubot, for instance, produced a fatal infection by inoculating dogs with material from an infected lion. Strauss inoculated huge doses of culture into the veins of adult dogs with the result that the animals died with lesions of glanders in the skin and internal organs. Tedeschi also induced a fatal infection by inoculating cultures into the brain, spinal cord and nerves.

Rabbits.—Rabbits are only slightly susceptible to experimental inoculation. Sub-cutaneous inoculation is followed by an ulcer which resolves spontaneously. Intra-venous inoculation of cultures is followed by death (Lœffler). A virus which has been passed through ground squirrels will kill rabbits on sub-cutaneous inoculation (Gamaléia).

Cattle. Swine.—These animals are practically immune against glanders. Spinola, however, has succeeded in infecting pigs, and Cadéac and Mallet have shown that pigs are susceptible to infection when their resistance has been lowered by some antecedent disease.

Rats. Birds.—Both rats and birds are immune to glanders.

SECTION II.—MORPHOLOGY.

1. Microscopical appearance.

The glanders bacillus is a small, straight or slightly curved, non-motile, rod-shaped organism of about the same length (3–5 μ) as but thicker than the tubercle bacillus: the ends of the bacillus are rounded. In cultures the organisms occur singly or in pairs while in the tissues and in pus they are often found in small masses. Occasionally the bacilli are so short as to have the appearance of micrococci, but on the other hand long branched filamentous forms are sometimes found. In old cultures involution forms consisting of filamentous irregularly swollen bacilli and granules arranged in chains like cocci are seen.

Staining reactions.—The glanders bacillus stains with solutions of the aniline dyes containing a mordant such as Lœffler's blue, Kühne's blue, carbol-thionin, or carbol-fuchsin. It does not stain by Gram's method.

In stained preparations the glanders bacillus has a granular appearance,

parts of the protoplasm remaining unstained : these unstained parts do not however represent spores.

Sections.—For staining the bacilli in sections either Nicolle's tannin method or one of the following may be employed :

Kühne's method.—1. On taking the sections out of alcohol, wash them in water and stain for a few minutes with carbol-blue.

2. Pass the sections rapidly through a 1 per cent. aqueous solution of hydrochloric acid and wash in water.

3. Dehydrate very quickly in alcohol and aniline oil : wash carefully in xylol and mount in balsam.

Löffler's method.—1. Stain for a few minutes in aniline-fuchsin (prepared in a similar manner to aniline-violet) to which 1 part in 10,000 of caustic potash has been added.

2. Wash rapidly in a 1 per cent. solution of acetic acid. Wash in water.

3. Dehydrate rapidly in alcohol and aniline oil, wash carefully in xylol and mount in balsam.

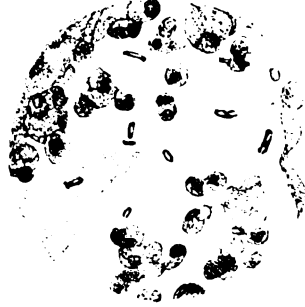

FIG. 235.—Film preparation from an infected testicle showing glands bacilli. Carbol-thionin. (Reich; obj. $\frac{1}{4}$ th in.; oc. IV.)

2. Cultural characteristics.

Conditions of growth.—The glands bacillus is an aerobic organism ; it hardly grows at all below 25° C., but on glycerin-agar it yields a scanty growth when incubated at 23°–24° C. Growth is arrested at 42° C. The optimum temperature for cultivation is 35°–38° C.

Characters of growth on ordinary media. Broth.—When sown in broth and incubated at 37° C. for 24 hours the bacillus produces first a cloudiness of the medium and later a white, mucous deposit. A culture on this medium has no characteristic feature.

Agar. Glycerin-agar.—After incubating for about 24 hours a narrow whitish streak is seen along the line of sowing. The culture is at first semi-transparent but as the layer thickens it becomes opaque. On glycerin-agar growth takes place more freely and may spread over the whole surface of the medium.

Coagulated serum.—Horse serum is the best for the growth of the glands bacillus. Semi-transparent colonies appear in about a couple of days which become white and opaque as growth progresses.

Gelatin.—On a 12 or 15 per cent. gelatin—which will remain solid at 25° C.—a very scanty almost invisible growth is formed after incubating at 25° C. for several days.

Potato.—Under suitable conditions the growth of the glands bacillus on potato is characteristic. Potatoes which are either

naturally rich in starch or which have been made alkaline should be used if the characteristic appearances are to be developed to the best advantage. After incubating for 48 hours at 37° C. a thick yellowish viscous film appears along the line of sowing, which as the growth extends during the next few days becomes brown and then acquires a chocolate colour, while the potato in the neighbourhood of the growth turns black.

Milk.—Milk is coagulated in about 10–12 days.

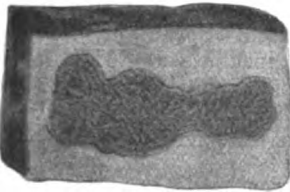

FIG. 236.—Cultivation of the glands bacillus on potato (7 days).

SECTION III.—BIOLOGICAL PROPERTIES.

1. Viability and Virulence.

Viability.—The glanders bacillus is a delicate organism. Cultivations of the bacillus kept at 37° C. die out in about a month, and exposure to a temperature of 55°–60° C. will sterilize them in a few minutes. Bacilli in pus are rapidly killed by desiccation, and if some glanders pus be spread in a thin layer and left at the ordinary temperature of the atmosphere for 48 hours it will no longer produce an infection on inoculation. In the tissues and internal organs the bacillus is more resistant but can be destroyed by exposure to a temperature of 100° C. for a few minutes.

The glanders bacillus is also readily killed by antiseptics so that an exposure to any of the following solutions for a few minutes will sterilize it—0·1 per cent. acid solution of perchloride of mercury, 3 or 4 per cent. solution of cresol, or solutions of carbolic acid.

Virulence.—The virulence of a given culture of the bacillus is said to disappear in a week. If frequently sub-cultivated on artificial media the virulence will be found to have considerably diminished by the fifth or sixth sub-culture. Young cultures of recently isolated organisms are very virulent and a certain amount of risk attaches to the manipulation of them.

The virulence of the bacillus is readily increased by passage through certain animals.

Gamaleía raised the virulence of the bacillus considerably by passage through ground squirrels. Protopopoff exalted the virulence by passage through rabbits and found that after several passages the virulence became fixed, so that on inoculation beneath the skin rabbits invariably died in from 5–8 days. Trasbot has brought forward certain facts which seem to show that the virulence is increased by passage through lions.

2. Toxin.

Cultures of virulent strains of the glanders bacillus sterilized at 100° C. exhibit toxic properties and quickly kill the inoculated animal. The toxin of glanders has not been isolated, but was made the subject of study first by Kalning and Helman and afterwards by Protopopoff, by Roux and Nocard, and by others. The term *mallein* has been applied to an extract of glycerin-broth cultures of the bacillus.

Preparation of mallein (Nocard).—For the preparation of mallein an organism the virulence of which has been raised and fixed by passage through rabbits (intra-venous inoculation) should be used. Sow a glycerin-broth medium with the infected rabbit's blood and incubate at 36° C. for one month; then sterilize the culture by heating it at 100° C. for half an hour, evaporate on a water bath to one-tenth its original volume and filter through Chardin paper. The brown syrupy filtrate constitutes crude mallein, 1 c.c. of which is sufficient to kill a rabbit.

If the crude product be treated with several volumes of alcohol a precipitate is thrown down containing the active principle mixed with other substances (*dry mallein* of Foth).

Mallein in the diagnosis of glanders (Nocard).—Nocard was able to demonstrate a very peculiar property of mallein. If inoculated in a very small dose into a healthy animal it leads to no symptoms, but if the same dose be administered to an animal suffering from glanders a sharp reaction is produced similar to the reaction following the inoculation of tuberculin into a tuberculous animal. If 0·25 c.c. of mallein be inoculated into a healthy horse no effect is produced, but if a similar inoculation be given to a glandered

horse a violent reaction follows characterized by an *œdema* at the site of inoculation, *rigors*, and a *rise of temperature*—of perhaps 3° or 4° C. within 24 hours—commencing a few hours after the inoculation and persisting for several days. Whenever an animal reacts in this way to an inoculation of mallein a diagnosis of glanders may be made with confidence.

The inoculation of mallein is a valuable agent in the diagnosis of those cases of glanders in the horse where there is neither ulcer nor nasal discharge—*latent glanders*; but it is not applicable to the diagnosis of glanders in man on account of the intensity of the resulting reaction.

When an animal is suffering from very advanced lesions or when the temperature of a suspected horse reaches or exceeds 39° C. the reaction may fail.

If the inoculation be followed by a rise of temperature not exceeding 1° or 1.5° C. the diagnosis must be regarded as doubtful, and the animal should be left alone for 3 or 4 weeks and then tested again: or if delay be inconvenient, by combining the original mallein test with cultivation and inoculation experiments—carried out with material from the suspected animal—it should be possible to come to a definite conclusion.

The method of conducting the mallein test.—In veterinary practice a diluted solution of mallein should be used rather than the crude product.

| | | | | |
|--|---|---|---|----------|
| 5 per cent. aqueous solution of carbolic acid. | - | - | - | 9 parts. |
| Crude mallein, | - | - | - | 1 part |

The horse to be tested should be kept in its stable for 2 days before the test is performed and its temperature taken morning and evening—because as already pointed out if the temperature before inoculation exceed 39° C. the reaction may fail. On the third day 2.5 c.c. of the diluted mallein is inoculated beneath the skin of the shoulder and the temperature taken thrice daily. In animals infected with glanders the temperature will begin to rise about 8–10 hours after the inoculation and will remain up for about 2 days.

Experiments have been carried out to determine whether, as is the case in the diagnosis of tuberculosis with tuberculin, a characteristic reaction occurs in glandered animals if mallein be instilled into the eye or dropped on superficial skin scratches; but all observers are agreed that these methods of applying the test are neither so reliable nor so constant in their results as the original method of sub-cutaneous inoculation.

3. Vaccination.

There are considerable difficulties in the way of prophylactic vaccination against glanders and up till the present the results have not been at all satisfactory.

Straus having shown that dogs could be infected by inoculating cultures of exalted virulence into the veins found that a previous inoculation of old attenuated cultures protected the animals against infection by intra-venous inoculation. But dogs immunized in this way are not immune against cutaneous inoculation which is followed by cutaneous ulcers; and Galthier has shown that by repeatedly inoculating an animal ulcers can be produced on as many as five successive occasions.

Sakaroff and Finger found that a previous inoculation of old cultures or of cultures sterilized by heat at 100° C. caused the disease to run a slower course than usual in rabbits but they were not able to prevent the animals from dying.

Nicolle has attempted the immunization of guinea-pigs by intra-cardiac inoculation of a virulent virus.

The immunizing experiments of Babès (injections of mallein), of Sakaroff

(inoculation of horses with a bacillus after passage through cats), and of Chenot and Picq (inoculation of guinea-pigs with ox serum) have given no conclusive results.

4. Agglutination.

In testing the agglutination reaction of the serum of an animal infected with glanders an emulsion in normal saline solution of a young culture on glycerin-agar should be used. It is better to sterilize the culture by heating it at 60° C. for an hour.

The serum of healthy horses agglutinates the bacillus in dilutions of 1 in 100 to 1 in 300, while that of infected animals under the same conditions will agglutinate the bacillus in dilutions of 1 in 500 to 1 in 1000 (Bourges and Méry, M'Fadyean, Pokchichevsky).

Normal human serum also agglutinates the glanders bacillus but the reaction is more marked in the case of persons suffering from the disease.

On the whole the agglutination reaction does not afford a practical method for the diagnosis of glanders.

SECTION IV.—DETECTION AND ISOLATION OF THE GLANDERS BACILLUS.

Distribution of the bacillus in the tissues.—In cases of glanders the bacillus can be found in the pus, in the discharges from the ulcers and nasal mucous membrane, in the farcy buds, and in tubercles and infarcts.

The lymphatic system is the site of election of the bacillus; as a rule the lymphatic glands are infected at an early stage, but this is not invariably the case, and Nocard has shown that the enlarged glands in the neck do not always produce glanders on inoculation into suitable animals.

In the lower animals the bacillus is practically never found in the blood (Nocard) except in very acute forms of the disease (Lixteyn and Preusse). In man the bacillus is found in the blood more often than in animals (Loeffler, Goutchakoff, Sittmann).

The saliva, urine, secretion of the testicles and of the sweat glands have in some cases been found to be infected but in no case has the milk been shown to contain the bacillus.

Note.—It is often impossible to detect the glanders bacillus by microscopical examination even in films of pus or of the contents of the tubercles from cases of glanders. The presence or absence of the glanders bacillus can neither be affirmed nor denied on microscopical examination alone; cultivation and inoculation experiments must be carried out in every case. The failure to find the specific bacillus is particularly common in chronic lesions, and especially in lesions of the horse. To find the bacillus by microscopical examination pus from dogs, or an enlarged testicle from a guinea-pig, or material from an acute lesion in the ass should be used.

The diagnosis of glanders.

The clinical diagnosis of glanders is often difficult and sometimes impossible without laboratory methods. The early diagnosis of latent glanders is only possible by using mallein in the manner described above. The present section is concerned only with laboratory methods of diagnosis—the detection and isolation of the bacillus.

1. Microscopical examination.—Pus, discharges from sores and scrapings of the internal organs, etc. will provide the material for examination. The films should be stained in the manner already described. The bacillus is gram-negative. Pieces of tissue for histological examination should be hardened in alcohol and embedded in paraffin.

2. Cultures.—Pus, scrapings of organs and other material must be collected with the necessary aseptic precautions and should invariably be sown on potato. The appearance presented by the glanders bacillus on this medium is characteristic (*vide ante*) and is an important factor in the diagnosis. Several tubes of potato should be sown in order to isolate the organism which may not always be present in pure culture in the material used.

3. Inoculations.—Before the discovery of mallein the inoculation of animals with pus, nasal discharge and other material from suspected cases of glanders was an experiment of first rate importance in the diagnosis of the disease. It has however been pointed out above that enlarged glands taken from animals suffering from the disease may fail to produce glanders on inoculation into healthy animals, and the method is to this extent a less certain means of diagnosis than the mallein test: it however affords valuable confirmatory evidence.

The suspected material should be inoculated into a guinea-pig, an ass or a dog.

(a) *Guinea-pigs.*—The inoculation of suspected material into the peritoneal cavity of a guinea-pig has been recommended by Strauss as at once the simplest and most certain method of diagnosing a case of glanders. The difficulty however is that the material used for inoculation must contain no organisms capable of setting up peritonitis in the inoculated guinea-pig, and in practice it is found that about one-half of the animals inoculated with the discharge from the nose die of septic peritonitis in 24–36 hours.

If the material therefore contains organisms other than the glanders bacillus it should be inoculated beneath the skin of a guinea-pig, and a second guinea-pig should be inoculated intra-peritoneally with a portion of a lymphatic gland from the first animal. (In these cases however it is often better to inoculate an ass with the suspected material.)

For purposes of inoculation rub up a little of the pus or nasal discharge or other material in a mortar with a little sterile water [or normal saline solution] and inject the emulsion into the peritoneal cavity of a male guinea-pig. In 2–3 days the characteristic enlargement of the testicle will become apparent and the animal will die in a week to a fortnight.

For a long time the appearance of an enlargement of the testicle—**Strauss' sign**—following the inoculation of material from a suspected case of glanders into the peritoneal cavity of a male guinea-pig was regarded as pathognomonic of glanders and as absolute proof of the material having been derived from a case of the disease. But Kutschen has isolated from the nasal discharge of a glandered horse an organism which while differing from the glanders bacillus in other respects, on inoculation into the peritoneal cavity of a male guinea-pig produces an orchitis similar to the orchitis produced by the glanders bacillus. Hallopeau and Bureau observed a similar orchitis develop after inoculating pus from a case of human mycosis into the peritoneal cavity of a guinea-pig. And Nocard has recorded nineteen cases of a slightly contagious, farcy-like lymphangitis in horses due to a bacillus which though it produced an orchitis on inoculation into guinea-pigs was absolutely different from the glanders bacillus both in its cultural characteristics and in its reaction to Gram's stain. The inoculation of a guinea-pig therefore can only be regarded as one factor in the diagnosis of a doubtful case of glanders and must be supplemented in every case by a microscopical examination of the pus in the testicle and by the mallein test (Nocard).

(b) *Asses.*—The susceptibility of the ass to glanders renders inoculation of that animal a valuable means of diagnosis: the animal should be inoculated through superficial scratches on the skin. If the material used for inoculation contain the specific bacillus the animal will almost invariably show the characteristic symptoms of the disease before the end of the second week (but see p. 480).

CHAPTER XXXII.

VIBRIO CHOLERÆ ASIATICÆ.

Introduction

Section I.—The experimental disease, p. 489.

1. Choleraic peritonitis, p. 489. 2. Choleraic septicæmia, p. 489. 3. Intestinal cholera in animals and man, p. 489.

Section II.—Morphology and cultural characteristics, p. 491.

Section III.—Biological properties, p. 493.

1. Vitality and virulence, p. 493. 2. Bio-chemical reactions, p. 494. 3. Toxin, p. 494. 4. Vaccination, p. 496. 5. Serum therapy, p. 498. 6. Bactericidal properties; Agglutination, p. 499. 7. Complement fixation, p. 500.

Section IV.—Detection, isolation and identification of the vibrio, p. 500.

1. Detection, p. 500. 2. Isolation, p. 501. 3. Identification, p. 502.

The vibrio of Finkler-Prior, p. 502.

The vibrio of Deneke, p. 503.

Vibrio metchnikowi, p. 503.

THE infecting agent in asiatic cholera is a vibrio discovered by Koch and often known as the comma bacillus. The vibrio is found in the intestinal contents and in the dejecta of patients suffering from the disease: it remains localized in the intestine and the symptoms of cholera are due to the absorption of toxin.

[The present conception of the distribution of the cholera vibrio in the tissues of man must however be revised in view of the recent observations of Kulescha and of Greig. Kulescha was the first apparently to show that the cholera vibrio could gain access to the gall-bladder and set up pathological changes in the biliary passages and Greig was able to isolate the vibrio from the bile of about one-third (81 out of 271) of the fatal cases of cholera coming under his observation at Puri in India. Moreover the finding by Zlatogoroff of the vibrio in the stool of a person one year after recovery leads to the suspicion that the organism may live in the gall-bladder for long periods and be excreted *via* the alimentary canal from time to time thus giving rise to "carriers" as in the case of enteric fever and other diseases.]

The cholera vibrio is essentially a pleomorphic organism; there are many varieties which differ more or less from the vibrio originally described by Koch. If it be added that it is not uncommon to find in water and in the excreta of healthy persons, vibrios morphologically similar to if not identical with the cholera vibrio, it will be understood how difficult and inexpedient a diagnosis of cholera may be in the absence of large epidemics.

SECTION I.—THE EXPERIMENTAL DISEASE.**1. Choleraic peritonitis.**

The inoculation of a culture of the cholera vibrio into the peritoneum of a guinea-pig generally leads to a rapidly fatal peritonitis (Pfeiffer) ; but this experimental peritonitis has no analogy whatever with the intestinal disease of man.

Vibrios from different sources differ widely in their virulence for the same animal species. Thus some vibrios which are not derived from cases of cholera in man will produce peritonitis in guinea-pigs, while others only recently isolated from the intestine of a person suffering from cholera may prove absolutely harmless to these animals.

There seems to be no relationship between the power of a vibrio to set up choleraic peritonitis in guinea-pigs and its ability to produce intestinal cholera.

To produce choleraic peritonitis in the guinea-pig scrape the growth from a young agar culture, rub it up in a little sterile broth and inject the emulsion into the peritoneal cavity. A few hours later the animal becomes drowsy, the temperature falls below normal, collapse sets in and is followed by convulsions and death. *Post mortem* there is considerable fluid in the peritoneal cavity in which a variable but small number of vibrios can be found : the intestine is distended and pink in colour, and the bacillus will be found in small numbers in its contents : there will be no visible lesions of the viscera. The vibrio may gain access to the blood stream.

The virulence of a vibrio may be increased by passage through the peritoneal cavities of guinea-pigs, but after passage through about twenty animals the virulence of the exalted virus appears to be fixed (Haffkine) and cannot be further increased.

2. Choleraic septicæmia.

Infection of guinea-pigs and rabbits by sub-cutaneous inoculation can only be effected when very virulent strains are used. In such cases the animal dies more or less rapidly from choleraic septicæmia, death being preceded by a fall of temperature, convulsions and collapse : the blood and viscera yield pure cultures of the vibrio. Ground squirrels are much more susceptible to inoculation with the cholera vibrio than guinea-pigs.

Intra-muscular inoculation appears to produce more severe symptoms than sub-cutaneous inoculation. Intra-venous inoculation produces in rabbits symptoms like those of cholera with lesions in the intestines (bluish red in colour with desquamation of the mucous membrane), while the organism is found in large numbers in the contents of the intestine, blood and viscera (Kolb and Issaëff).

Pigeons.—Non-pathogenicity for pigeons was for a long time thought to be one of the characteristic features of the cholera vibrio. This however is not the fact for Gamaléia and Metchnikoff have shown that many undoubted cholera vibrios are pathogenic for these birds ; the Angers vibrio, for instance, if inoculated into the pectoral muscles of pigeons will produce a rapidly fatal septicæmia.

3. Intestinal cholera.

The symptoms following sub-cutaneous or intra-venous inoculation of the cholera vibrio are very different from those characteristic of asiatic cholera in man. Attempts to infect animals by the alimentary canal failed to produce satisfactory results until the subject was taken up by Metchnikoff ; as a result of his experiments a considerable advance was made in the study of experimental intestinal cholera.

Animals.

I. Animals suffer no harm from being fed with cultures of the vibrio or with cholera stools; Nicati and Rietsch therefore, with the object of inoculating the material directly into the intestine, injected cultures into the duodenum of guinea-pigs after laparotomy. These observers were the first to produce intestinal cholera experimentally.

II. Koch obtained the same results but in another way. He injected directly into the stomach of a guinea-pig through an œsophageal tube, first a few c.c. of a 2 per cent. solution of carbonate of soda and a few minutes later a culture of the vibrio: at the same time tincture of opium (1-1.5 c.c.) was inoculated either into the peritoneal cavity or beneath the skin (Doyen uses 40 per cent. alcohol instead of opium). The animal died in two or three days from diarrhœa and collapse. *Post mortem*, the small intestine contained a watery fluid in which cream-coloured flakes were suspended and which yielded an almost pure culture of the vibrio.

III. Zabolotny showed that ground squirrels are very susceptible to infection with the cholera vibrio: if a number of these animals be fed with foodstuffs watered with a few drops of a pure culture of the vibrio, half the number become infected and die; the mortality is heavier if an alkaline salt be added to the infected meal, though some of the animals even then resist infection. The affected animals become weak and frequently suffer from diarrhœa, sometimes also from cramp with cyanosis of the nose and tongue; the temperature is sub-normal. *Post mortem* the intestinal canal is distended and hyperæmic and contains a fluid rich in vibrios; the latter often gain access to the peritoneal cavity and blood stream.

IV. Metchnikoff, conceiving the immunity of animals to intestinal cholera to be largely due to the action of organisms normally present in the intestine, experimented with a view to overcoming or at least diminishing such prophylactic action if it existed. He fed a number of young rabbits solely on their mothers' milk for some weeks: the intestinal flora under these conditions remained for a long time quite poor and but little varied. The growth on a twenty-four-hour agar culture (Massaouah vibrio¹) was scraped off with the bent end of a pipette and placed in the mouth of the young rabbits: in about one-half the cases the animals suffered from diarrhœa and died of intestinal cholera about the sixth day. *Post mortem* the intestines showed the characteristic lesions of cholera and numerous vibrios were found in the contents of the intestine.

V. Young chimpanzees can be fed with large quantities of the cholera vibrio without showing any symptoms.

VI. **Ancillary micro-organisms.**—Metchnikoff, after showing that in gelatin plate cultures some micro-organisms favour the growth of the cholera vibrio, investigated these ancillary properties particularly with regard to three organisms isolated from the human stomach, viz.: a white sarcina, a torula and a bacillus belonging to the colon group. Twenty out of twenty-two young rabbits fed with a mixture of the Massaouah vibrio and these organisms died of cholera. As a rule death occurred 36-48 hours after infection, but in a few cases was longer delayed; nearly all the animals were dead within 60 hours. The infected animals suffered from a watery diarrhœa with a colourless, serous, alvine discharge containing lumps of mucus: vomiting was rare, but suppression of urine very common. The abdominal walls were

¹ A vibrio isolated from some water at Versailles was found to be virulent for guinea-pigs on intra-peritoneal inoculation and to have the same effect on young rabbits as the Massaouah vibrio.

soft and flabby, the temperature fell to 30° C. or below and death took place, occasionally after a very prolonged agony. *Post mortem*, there were no lesions of the abdominal or thoracic viscera, the small intestine alone being hyperæmic, pink in colour and distended with a turbid fluid: the cæcum contained a large amount of thick alkaline serous fluid with mucous flakes in suspension. The fluid in the small intestine contained an enormous number of vibrios, most frequently in pure culture. The micro-organisms ingested at the same time as the vibrios disappeared after performing their ancillary rôle. In one-fourth of the cases the vibrio passed into the blood stream.

When young rabbits cease to feed entirely on milk their susceptibility to infection with cholera vanishes, and an immunity is established which cannot be overcome even with the assistance of other micro-organisms. The intestinal cholera of young rabbits is contagious and may be transmitted by the mammæ of the mother during suckling of the infected animals.

Young guinea-pigs a few days old are much less susceptible to infection than rabbits when fed with a mixture of the Massaouah vibrio and ancillary organisms. The disease from which they suffer is less characteristic of cholera than the disease in rabbits, and the vibrio exhibits a greater tendency to become generalized in the tissues of guinea-pigs.

Man.

It is many years since experiments were first conducted with a view to infecting the human subject with cholera by the alimentary canal (Boche-fontaine, Klein). In 1892, Pettenkofer and Emmerich swallowed pure cultures of Koch's vibrio, but though they had previously taken carbonate of soda and strictly regulated their diet, they merely suffered from an attack of choleraic diarrhœa unaccompanied by any general symptoms.

Hasterlik and Stricker, and Ferran also suffered from diarrhœa and vomiting after taking pure cultures of the vibrio.

On several occasions Metchnikoff and his pupils drank pure cultures of vibrios from different sources (from Hamburg, Courbevoie, Saint-Cloud, Paris, Versailles, etc.). The observer first took a gram of bi-carbonate of soda dissolved in a little water and immediately afterwards a varying amount of an agar culture rubbed up in a little sterile broth. Metchnikoff was able in this way to produce "a true asiatic cholera which although slight had all the classical symptoms" of the disease: "rice water" stools, sub-normal temperature, vomiting, cramps, suppression of urine, and vibrios in almost pure culture in the stools.

SECTION II.—MORPHOLOGY.

Cholera vibrios are essentially pleomorphic; their shape, the number of their flagella and their cultural characteristics being all very variable. This pleomorphism renders their identification singularly difficult.

1. Microscopical appearance.

The typical cholera vibrio (of Koch) occurs as a stumpy rod—1.5–3 μ long and 0.5–0.6 μ broad—slightly curved like a comma; the degree of curvature is very variable. In the field of the microscope some of the vibrios appear to be straight, but

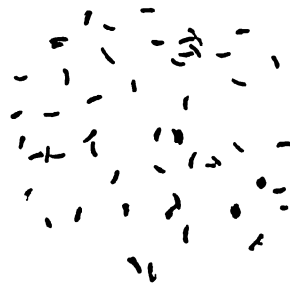

FIG. 237.—*Vibrio cholerae* (Indian strain). Film from an agar culture. Dilute carbol-fuchsin. (Reich; oc. II.; obj. $\frac{1}{4}$ th.)

in these the line of curvature is perpendicular to the surface of the slide: the eye only sees the projection on the plane of the slide and the curve vanishes. The vibrio is flagellated and is very motile.

There are however varieties of the cholera vibrio which differ markedly from that of Koch. Some are slender, irregularly-curved and occasionally have an elongated S shape—the Massouah, Courbevoie and Paris vibrios. Others are straight and never show any curve—the Shanghai vibrio; others again are very small and of a cocco-bacillary form—the Malta vibrio. Metchnikoff also noticed further when sub-cultivating an old culture of the Angers vibrio in peptone water that it had a slender elongated form, whereas ordinarily it was stumpy and curved.

Involution forms occur in cultures several days old: many of the organisms are irregularly swollen while others have the form of rounded bacilli of variable size.



FIG. 238.—*Vibrio cholerae* (Massouah strain). Film from intestinal contents. Dilute carbol-fuchsin. (Reich; oc. II.; obj. $\frac{1}{4}$ th.)

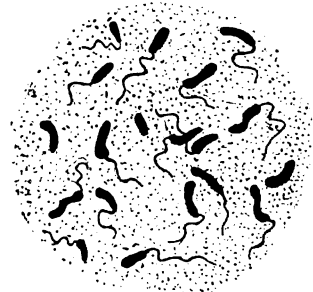

FIG. 239.—*Vibrio cholerae* (Indian strain). Stained to show flagella: Nicolle's method. (Reich; oc. IV.; obj. $\frac{1}{4}$ th.)

According to Hueppe, some of these spherical bodies represent resistant forms or arthrospores formed by encystment of the vibrios; they are however no more resistant to adverse influences than the vibrio itself.

Staining reactions.—The cholera vibrio is not so easily stained as most pathogenic bacilli and rather strong staining solutions containing a mordant should be used. Carbol-fuchsin diluted with 3 or 4 times its volume of water is a very useful stain. The vibrios are gram-negative.

Flagella.—The number of flagella and their arrangement are very variable. The typical cholera vibrio of Koch has one flagellum situated terminally [monotrichous]; some varieties have two, three or even four terminally situated flagella [lophotrichous] (Nicolle and Morax, Kolle, and Gotschlich). The flagella may be stained in the living condition by Straus' method or, after drying and fixing, by the methods described at p. 148 *et seq.*: it is necessary always to use young agar cultures.

2. Cultural characteristics.

Conditions of growth.—The cholera vibrio is essentially an aerobic organism; a very scanty growth may however be obtained under anaerobic conditions (Hueppe and Scholl). The organism grows at all temperatures between 12° and 40° C., the optimum being 37° C. It grows on all the ordinary neutral or slightly alkaline media and ferments sugars.

Characteristics of growth. Broth. Peptone water.—When sown in these media and incubated at 37° C. the cholera vibrio rapidly (6–10 hours) produces a cloudiness of the medium, and later a thin whitish very delicate pellicle forms on the surface of the liquid; ultimately a flaky precipitate is deposited.

Gelatin. Stab culture.—After incubating at 20° C. for 20 hours small colonies appear along the line of the stab. A small cup-shaped depression is formed at the surface in which a bubble of air is retained; liquefaction then increases and progresses in a funnel-shaped manner being more marked at the surface than in the depth, the bubble of air remaining at the surface: about the second to the fourth day the growth is characteristic. The medium is subsequently entirely liquefied.

Single colonies.—After incubating at 20° C. for about 20 hours small whitish points are visible which quickly become irregular-shaped colonies with granular centres surrounded by a bright ring. Liquefaction then commences: a small cup-shaped depression is formed with the colony in the centre from the periphery of which small clumps of vibrios become detached, and the plate is soon completely liquefied.

Agar.—Incubation at 37° C. gives a copious whitish growth which develops rapidly but has no special features.

Isolated colonies are irregular and greyish: the centres are granular and surrounded by a smooth marginal zone.

Coagulated serum.—The growth on this medium is rapid. The serum is liquefied.

Potato.—The cholera vibrio grows well only on alkaline potato (p. 55); on this medium a thick clear brown streak is formed.

Milk.—This medium is sometimes coagulated.

Koch believed that one of the characteristics of the cholera vibrio was that it did not clot milk. Since then however it has been shown that some varieties of cholera vibrios of the identity of which there can be no doubt produce quite a distinct clot.



FIG. 240.—*Vibrio cholerae* (Indian strain). Stab culture in gelatin (5 days).

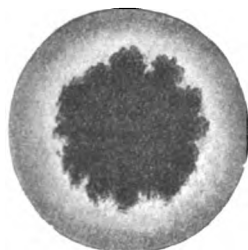

FIG. 241.—*Vibrio cholerae* (Indian strain). Single colony on gelatin plate. $\times 60$.

SECTION III.—BIOLOGICAL PROPERTIES.

1. Vitality and Virulence.

The cholera vibrio retains its vitality for a long time in artificial culture, provided that the tubes be kept in the dark and be prevented from drying up. Under these conditions agar cultures will be found to be living after 5 months.

The cholera vibrio is very rapidly killed by drying, especially in artificial cultures.

A temperature of 50°–60° C. kills the vibrios in ten minutes: on the other hand very low temperatures (–10° C.) have no action on their vitality.

The vibrio is very susceptible to the action of acids and antiseptics: traces of perchloride of mercury, quinine sulphate, etc., arrest growth in culture.

Cholera vibrios have been found to be capable of living for from 15–30 days in spring water (Strauss and Dubarry). They are destroyed in three or four days in excreta by the action of putrefactive bacteria (Koch).

In discussing the disease experimentally produced in animals stress has

already been laid on the variations in the virulence of the vibrios. The virulence of the organism rapidly becomes attenuated in cultures but can be increased by passage through susceptible animals (*vide infra* Toxin).

Cholera vibrios are very susceptible to the action of micro-organisms with which they may be associated (Metchnikoff). It has already been pointed out that certain organisms favour the growth in culture of the cholera vibrio; there are others however which have an adverse influence, *e.g.* *Bacillus pyocyaneus*, and a white coccus isolated from water. This white coccus has a remarkable effect on the vibrio; during the first few days it prevents any growth at all taking place; after a little while the organism begins to grow, but the colonies are few in number and small in size and composed not of "comma" bacilli but of double club-shaped involution forms (Metchnikoff).

2. Bio-chemical reactions.

Nitroso-indol reaction.—In cultures in peptone water the cholera vibrio reduces nitrates to nitrites and produces indol. If a mineral acid free from nitrous compounds be added to a peptone water culture of the cholera vibrio a characteristic red reaction develops, known as the cholera-red or nitroso-indol reaction (reaction of Bujwid and of Salkowski).

The reaction is most striking if a little nitrate of potassium be added to the peptone water. A useful medium in which to grow the vibrio in order to obtain the cholera-red reaction is composed of:

| | | | | | | | |
|---|---|---|---|---|---|-------|--------|
| Peptone (Chapoteaut or Witte), ¹ | - | - | - | - | - | 10 | grams. |
| Common salt, - | - | - | - | - | - | 5 | „ |
| Potassium nitrate, - | - | - | - | - | - | 1 | „ |
| Water - | - | - | - | - | - | 1,000 | „ |

This solution is alkaline in reaction and does not require the addition of soda. Sterilize at 115° C.

Sow the peptone-water solution with the vibrio and incubate at 37° C.: after 24 hours' incubation add gently 1–2 c.c. of pure sulphuric or hydrochloric acid. The peptone solution acquires a pink tint which deepens in intensity during the next few hours.

Not all cholera vibrios give the nitroso-indol reaction, while on the other hand the reaction is produced by certain other micro-organisms which are not cholera vibrios.

Indol reaction.—The cholera vibrio produces indol in cultures (p. 374).

3. Toxin.

Cholera is an acute toxæmia caused by the absorption of a toxin elaborated by the cholera vibrio in the intestine. The toxin of cholera has for years been a subject of investigation.

I. Brieger and Fränkel described the occurrence of an albuminoid substance of unknown composition—tox-albumin—in cultures of the cholera vibrio; this substance they regarded as a diastase. Utchinsky showed that the same toxin is elaborated in an exclusively mineral medium.

Petri prepared a toxin which led to a fatal result in guinea-pigs when inoculated intra-peritoneally in doses of 2 c.c. The organism was grown on a 5 per cent. peptone solution and sterilized at 120° C.; it follows therefore that the cholera toxin, which Petri describes as toxo-peptone, is not destroyed at the temperature of boiling water, and for this reason is essentially different in its nature from diphtheria toxin.

¹ A good quality peptone must be used. It is said that the presence of glucose in some brands of peptone prevents the formation of indol and so leads to a negative reaction (Gorini).

Hueppe and Scholl grew the vibrio in the interior of fowls' eggs (p. 53, A.), the object being to cultivate it under conditions similar to those obtaining in the human intestine. After incubation the contents of the eggs were precipitated with alcohol and the precipitate dissolved in sterile water; this solution was highly toxic and killed guinea-pigs in a few minutes. Gruber and Wiener however showed that this result was in no way specific but can be produced by the sulphuretted hydrogen developed in the cultures and by the alcohol used in the precipitation.

II. Gamaléia maintains that there are several cholera toxins. This observer grew the vibrio in calf's-foot broth for a fortnight at 37° C. and then left the cultures standing for some days at the temperature of the laboratory to allow the intra-cellular products to diffuse. This fluid is said to contain two toxins: one thermolabile, producing diarrhœa in rabbits; the other thermostable, killing rabbits without any symptoms of diarrhœa.

In Pfeiffer's view, the toxin is contained within the bodies of the vibrios themselves (endotoxin) and only diffuses on the death and disintegration of the organism: the toxins found in solution in cultures are according to this observer merely a more or less modified product derived from the bodies of the vibrios.

Schmitz, Jurro, Blell, extracted a nucleo-protein from cholera vibrios which was very toxic to guinea-pigs (p. 497). The procedure was similar to that adopted by Lustig and Galeotti in the case of plague (p. 470). The vibrios were dissolved in a 1 per cent. solution of potash and the solution precipitated with acetic acid.

Krawkoff by a different method extracted a similar nucleo-protein from unfiltered broth cultures.

III. Metchnikoff, Roux, and Taurelli-Salimbeni prepared a very powerful soluble toxin which diffuses during the life of the organisms. Ransom obtained similar results.

Toxin of Roux, Metchnikoff and Taurelli-Salimbeni.

Preparation of the toxin.—1. Select a highly toxigenic vibrio.

It is best to isolate a vibrio direct from a patient suffering from cholera and one which has not been passed through animals. Vibrios isolated from man are generally very toxigenic, and to retain their virulence they should be sub-cultivated at room temperature on agar but as seldom as possible.

Vibrios which have been passed through the peritoneal cavities of guinea-pigs to increase their virulence are generally only feebly toxigenic, but their toxin-producing capacities can be augmented by passages in collodion sac cultures in guinea-pigs. After filling a collodion sac with peptone water sow it with the vibrio (p. 175) and then introduce it with aseptic precautions into the peritoneum of a guinea-pig; leave it for 48 hours and then inoculate the contents directly into the peritoneal cavity of another guinea-pig: sow a second sac with the peritoneal exudate from this second animal and repeat the operation several times, each intra-peritoneal incubation in collodion sacs being alternated with direct inoculation into the peritoneal cavity. In this way the vibrio acquires such a degree of virulence that the contents of the collodion sac rapidly kill a medium-sized guinea-pig when inoculated intra-peritoneally in doses of 0·006 c.c.

The virulence is maintained by making collodion sac cultures in the peritoneum every third or fourth day.

2. Sow the organism in the following medium:

| | | | | | | |
|----------------------------|---|---|---|---|---|-------------|
| Martin's peptone solution, | - | - | - | - | - | 1000 grams. |
| Gelatin, | - | - | - | - | - | 20 " |

Boil the solution to dissolve the gelatin, make absolutely neutral to litmus and add 12 c.c. of normal soda solution. Heat at 115° C. for 20 minutes, filter through Chardin paper, distribute in flasks and sterilize at 110°-112° C. for 20 minutes.

When cool, add to the contents of each flask one-fourth its volume of horse serum. The blood should have been collected 3 weeks previously and the serum should be

left standing on the clot in the ice chest for a week before being decanted. In the original method there was no serum in the culture medium, its addition being suggested by the investigations of Brau and Denier (*vide infra*).

Distribute the medium in Roux bottles—50 c.c. in each—and heat the latter with their contents at 60° C. for 3 hours to destroy the bactericidal substances in the serum.

Sow the medium liberally with 16 or 18-hour agar cultures and incubate at 38° C. Growth takes place in the form of a thin pellicle and the contents should be shaken daily for the first 4 days to increase the aëration. Filter the culture on the seventh day (when the content of toxin is at its maximum) first through paper then through a Chamberland filter.

Brau and Denier state that a very constant yield of toxin can be obtained in the following medium :

| | |
|---|---------|
| Sterile Martin's gelatin-broth, | 45 c.c. |
| Normal horse-serum (3 weeks old), | 45 " |
| Defibrinated horse-blood (3 weeks old), | 10 " |

Mix and heat the mixture at 60° C. for 3 hours and distribute in Roux bottles. Sow the medium freely and filter after incubating for 7 days, at 39° C.

Properties of the toxin.—The filtrate obtained is alkaline and has a characteristic smell: it kills guinea-pigs in doses of 0·1–0·3 c.c. per 100 grams of body weight. The toxin is unchanged by heating at 100° C. for 20 minutes. Its toxicity is diminished by exposure to air—especially in presence of sunlight—but it retains its properties if stored in tubes which are exactly filled, sealed in the blow-pipe flame and kept in the dark. Absolute alcohol and ammonium sulphate precipitate the active principle from the solution.

Action of the toxin on animals.—Small or medium-sized guinea-pigs are more susceptible to cholera toxin than any other animal: large guinea-pigs are more immune. The toxin is equally virulent whether inoculated sub-cutaneously or intra-peritoneally; death takes place in 10–30 hours after inoculation of medium-sized doses (1 c.c. sub-cutaneously or 0·3 c.c. intra-peritoneally for guinea-pigs weighing 250 grams). By using a large quantity of toxin a fatal result can be obtained in a few minutes, especially if it be inoculated intra-peritoneally.

The symptoms are similar to those which follow the inoculation of living cultures of the organism, but the incubation period is shorter: immediately after inoculation the temperature falls to below normal and continues low until death occurs, when it may have fallen to 24° or 25° C. *Post mortem*, there is a little œdema at the site of inoculation, a little fluid in the peritoneum, hyperæmia of the small intestine and stomach and congestion of the abdominal viscera: the intestine is distended with liquid diarrhœal matter. When the quantity of toxin inoculated is very small there is a temporary rise of temperature followed by a fall to below normal and the animal recovers.

Rabbits are weight for weight more resistant than guinea-pigs: for a rabbit the dose must be one-third greater than that required to kill a similar weight of guinea-pig. A fatal result in adult rabbits can only be produced by intra-venous inoculation.

Mice, rats, pigeons and fowls are almost immune.

4. Vaccination.

The ease with which laboratory animals can be vaccinated against the cholera vibrio has for a long time stimulated attempts to vaccinate man. Numerous methods have been described but only two, Ferran's and Haffkine's, have been applied on a large scale, and the evidence adduced as to the value of these is based entirely upon statistics.

I. Ferran's vaccine.—Ferran demonstrated that guinea-pigs which have

survived the sub-cutaneous inoculation of a small dose of a cholera culture are immune to fatal doses. He therefore applied this method of immunization to man and has performed more than 50,000 vaccinations. The results show that after two or three sub-cutaneous inoculations of his cultures (which give rise to a slight febrile reaction) the vaccinated individuals are immune against cholera.

For the preparation of the vaccine Ferran uses a vibrio isolated from cholera stools by the gelatin plate method. The vibrio is grown in broth at 37° C. and for vaccination purposes quantities of 1, 1.5 and 2 c.c. of the culture are inoculated successively at intervals of 5 days.

The results of Ferran's prophylactic vaccination have been much criticized. At all events he was the first to attempt the vaccination of man against cholera, and the methods advocated since are nothing more than modifications of his procedure.

Gamaleia suggested the use of cultures killed by heat in place of living organisms. Tamancheff employed cultures killed by carbolic acid.

II. Haffkine's vaccine.—Haffkine considers that to ensure satisfactory vaccination against cholera a fixed virus of increased virulence should be used.

To immunize guinea-pigs Haffkine inoculates them first with an attenuated strain and afterwards with a strain which has been increased in virulence. He takes a vibrio whose virulence has been raised and fixed by twenty passages through the peritoneal cavities of guinea-pigs and attenuates it by sub-cultivating it several times in broth at 39° C. in a current of air. The cultures thus obtained produce only a local and general reaction on sub-cutaneous inoculation into the guinea-pig. The animal is then inoculated sub-cutaneously with the virus of increased virulence, which is found to cause no disturbance of its health. After this it is immune against all methods of infection with the vibrio (sub-cutaneous and intra-peritoneal inoculation and ingestion).

This method nevertheless failed to immunize ground-squirrels and suckling rabbits against experimental intestinal cholera (Zabolotny, Metchnikoff).

To vaccinate man against intestinal cholera, Haffkine proposed inoculating beneath the skin first an attenuated virus and a week later one of his virulent cultures ($\frac{1}{20}$ th to $\frac{1}{10}$ th of an agar culture). This method was subsequently modified and he now gives a single inoculation of a virulent virus recently recovered from the peritoneum of a guinea-pig. In the case of an adult he injects 0.5 c.c. of an emulsion of an agar culture in about 5 c.c. of sterile water. The results obtained by Haffkine, Powell, Simpson, Wright and others seem very satisfactory.

III. Kolle's vaccine.—For human vaccination, Kolle uses agar cultures made into an emulsion (with sterile normal saline solution) and heated at 56° C. for an hour. The inoculation of $\frac{1}{10}$ th to $\frac{1}{5}$ th of an agar culture sets up a painful inflammation at the site of inoculation which lasts 2 or 3 days. From the fifth day after inoculation the serum of the inoculated individual is endowed with both bactericidal and bacteriolytic properties, and these can still be demonstrated so long as a year afterwards.

According to Kolle it is a matter of indifference in the case of the guinea-pig whether a virulent or non-virulent vibrio be used. This fact confirms Ferran, who considers that no value attaches to increasing the virulence of the virus by animal passage for the preparation of human vaccines.

IV. Vaccination with bacterial extracts.—The extracts prepared by Schmitz, Turro, Blell (p. 495) are toxic for guinea-pigs: 10–15 mg. is a fatal dose, but if smaller doses (1–5 mg.) be used the animal is immune for several months against both the toxin and the organism. For human vaccination 2 mg.

of the nucleo-protein dissolved in 1 c.c. of slightly alkaline water are inoculated sub-cutaneously.

Strong's vaccine for human inoculation is prepared by making an emulsion in sterile water of vibrios from an agar culture, sterilizing at 60° C., macerating at 37° C. for 2 days, and filtering through a Reichel bougie. In large doses the product is fatal to rabbits but in smaller doses acts as a vaccine. If inoculated in doses of 3-4 c.c. in man it produces a slight reaction and the serum of the inoculated person is afterwards bactericidal and agglutinating.

V. Besredka's vaccine.—Besredka succeeded in conferring rapidly a lasting immunity on rabbits without setting up an inflammatory reaction by inoculating them sub-cutaneously with a vaccine prepared by sensitizing the bodies of the vibrios with an anti-choleraic serum (see typhoid bacillus and plague bacillus).

VI. Vaccination against choleraic peritonitis.—Guinea-pigs are very easily immunized against peritoneal infection. Intra-peritoneal inoculation of vibrios killed by heat is efficient in preventing a subsequent choleraic peritonitis. To obtain a lasting immunity the single inoculation of dead vibrios should be supplemented by several inoculations of living organisms.

Klein has shown that the products of organisms other than the cholera vibrio can induce immunity to choleraic peritonitis: intra-peritoneal inoculation of small doses of a heated culture of the *Micrococcus prodigiosus* will immunize guinea-pigs against fatal doses of the vibrio. Israël has found that sterile broth inoculated intra-peritoneally will also immunize guinea-pigs against choleraic peritonitis. Inoculations of human serum (*vide infra*), of normal saline solution or of urine all act in a similar manner (Israël, Metchnikoff). The explanation of these phenomena is to be found in the fact that the substances inoculated stimulate phagocytosis, with the result that the leucocytes ingest the vibrios and so arrest the peritoneal infection.

VII. Vaccination with toxin.—Metchnikoff, Roux and Taurelli-Salimbeni showed that animals very quickly become accustomed to cholera toxin and that guinea-pigs, rabbits, horses and goats may be immunized by inoculating them with toxin.

When guinea-pigs and rabbits are treated with small doses of toxin the temperature rises for a short period after each inoculation and then falls below normal for about 20 hours. Repeated inoculations are accompanied by a certain loss of weight from which the animals soon recover, though rabbits are slower in picking up than guinea-pigs: the inoculations should be withheld until the animals have regained their original weights. It is somewhat difficult to immunize rabbits satisfactorily.

The inoculation of 2-4 c.c. into goats is followed by a rise of temperature which becomes less marked as the animal becomes accustomed to the inoculations.

Horses react sharply to sub-cutaneous inoculation of the toxin and show a well-marked and persistent œdema at the site of inoculation. For purposes of immunization it is better to adopt the intra-venous method, commencing with very small doses (always dilute the toxin with an equal volume of normal saline solution on account of the high degree of alkalinity of the former). Inoculation into the veins is followed by a more or less marked reaction (fever, diarrhoea, etc.); an interval of about 10 days—sufficient to allow the animal to recover completely from the previous dose—should elapse between each two inoculations. After about 6 months, 50-60 c.c. can be given at a single inoculation. The horse is bled 12 days after the last inoculation.

5. Serum therapy.

The serum of animals vaccinated against the cholera vibrio exhibits prophylactic properties (Klemperer).

Lazarus has shown that the serum of persons who have recovered from an attack of cholera also possesses considerable prophylactic properties: in some cases 1 c.c. of serum will protect a guinea-pig against choleraic peritonitis. The prophylactic property of the blood however plays no part in

the cure of human cholera, for Metchnikoff and Klemperer have shown that the serum of persons who have never suffered from cholera is sometimes prophylactic, that the prophylactic property of the blood may be very highly developed in the blood of persons who have just died of cholera, and that it is on the other hand often absent in persons convalescent from the disease (Metchnikoff).

I. Antibacterial serum.—Pfeiffer vaccinated guinea-pigs with cholera vibrios (p. 498) and obtained a serum active in $\frac{1}{15}$ mg.—that is to say a serum of which $\frac{1}{15}$ mg. was sufficient to vaccinate a guinea-pig against choleraic peritonitis if injected either before, or at the same time as, or within 5 minutes of the vibrios. The serum is bactericidal and agglutinates the cholera vibrio (*vide infra*).

Metchnikoff has shown that Pfeiffer's serum has no antitoxic properties: it is very efficient in protecting the blood and organs against infection because it stimulates phagocytosis and allows the leucocytes to ingest the organisms, but it is absolutely useless against intestinal cholera which is an intoxication.

Reaction of immunity.—Pfeiffer has suggested using the immunizing property of the serum of vaccinated animals as a means of differentiating the cholera vibrio from allied species: according to Pfeiffer, the serum of an animal vaccinated against cholera protects guinea-pigs against infection with the cholera vibrio but not against closely related organisms. To determine the nature of a vibrio then it is sufficient to inoculate the organism under investigation into a guinea-pig treated with anticholera serum: it is said that the animal will only resist infection when the vibrio inoculated belongs to the choleraic group.¹ Metchnikoff has shown that this test is of but little value: the reaction of immunity may fail in the case of vibrios isolated from the stools of cholera patients and be present in the case of saprophytic vibrios.

II. Metchnikoff, Roux and Taurelli-Salimbeni's serum.—The serum of horses immunized with toxin according to the directions of these observers (*vide ante*) is bactericidal and agglutinating: it is also prophylactic against choleraic peritonitis in guinea-pigs, the prophylactic dose lying between 0.01 and 0.005 c.c. It is antitoxic and protects against intestinal cholera.

This serum, if inoculated sub-cutaneously into small rabbits in doses of 4–8 c.c. before feeding them with cholera vibrios, will protect them against intestinal cholera. Out of 100 rabbits treated with the serum 56 escaped infection while only 16 per cent. of the controls survived. The serum is efficient if administered at the same time as the animals are fed with the virus but it has no effect at all if the animals be fed 24 hours before the administration of the serum. The value of this serum in human cholera has yet to be proved.

6. Bactericidal properties. Agglutination.

1. Pfeiffer was the first to demonstrate the bactericidal and agglutinating properties of the serum of immunized animals *in vivo*.

Pfeiffer's phenomenon.—If an emulsion of cholera vibrios be inoculated into the peritoneal cavity of a guinea-pig immunized against the vibrio, the peritoneal fluid will in a short time—10–30 minutes—be found on microscopical examination to contain only non-motile small more or less granular spherical micro-organisms.

Experiment.—Inject into the peritoneal cavity of an immunized guinea-pig 2 c.c. of sterile broth in which one-half of an agar culture of the vibrio to be examined

¹ A control guinea-pig which has not been treated with the cholera serum must of course be inoculated at the same time with the vibrio under investigation.

has been emulsified. Ten minutes afterwards withdraw, with a very fine-pointed pipette, a few drops of the peritoneal fluid and examine it under the microscope (either stained or unstained). If the vibrios are motile and have retained their characteristic shape, the reaction is negative, and the vibrio is not a cholera vibrio. If on the other hand only non-motile spherical dots are seen, then the vibrio may be regarded as a true cholera vibrio (*vide* also p. 227).

If there be no immunized guinea-pig at hand, inoculate a normal guinea-pig intra-peritoneally with an emulsion of the vibrio mixed with a little tested anticholera serum. The same granular change will be seen as in the foregoing case, and in addition the organisms will be agglutinated into small clumps.

2. The vibrios are equally agglutinated and disintegrated by an anticholera serum *in vitro* (Metchnikoff, Bordet).

To demonstrate this phenomenon rub up a small quantity of an agar culture in a little sterile broth and examine under the microscope to make sure there are no clumps: then add 5 to 10 per cent. of the serum and in a few minutes agglutination followed by granulation of the bacilli will occur, the result being most marked when the mixture has been incubated for 2 hours at 37° C.

An agglutinating serum can be easily obtained by inoculating cultures killed by heat into the peritoneal cavity or into the veins of a guinea-pig or rabbit.

Applications.—The phenomenon of agglutination furnishes a means of identifying the vibrio: as a rule, Pfeiffer's phenomenon on the one hand and agglutination *in vitro* on the other occur only with cholera vibrios and not with closely related species. In practice it will be sufficient to perform one of these tests because no vibrio has yet been encountered which gives one and not the other and *vice versa*. Unfortunately the value of the method is not absolute since it sometimes fails with vibrios isolated from the stools of cholera patients and may be produced with vibrios devoid of all pathogenic properties.

Serum diagnosis.—The serum of persons suffering from cholera will agglutinate an emulsion of the cholera vibrio in 5–60 minutes in a dilution of 1 in 20 (Achard and Bensaude). This reaction furnishes a rapid method of diagnosis, but it has to be remembered that normal human serum may agglutinate the vibrio in a dilution of 1 in 10 (Pfeiffer and Kolle).

7. Complement fixation.

Cholera serum contains immune bodies (*sensibilisatrices*) specific for the vibrio. The complement fixation reaction applied according to the method of Bordet and Gengou (p. 232) gives very accurate results in differentiating the cholera vibrio from organisms allied to it (de Besche and Kon).

SECTION IV.—DETECTION, ISOLATION AND IDENTIFICATION OF THE CHOLERA VIBRIO.

The detection and isolation of vibrios in general is easy, but identification of the cholera vibrio in particular presents considerable difficulties.

1. Detection and isolation.

A. Microscopical examination.

This method of investigation is applicable only to the examination of stools, or of the exudates and tissues of animals.

Detection in the excreta.—Take one of the small mucous or riziform particles, spread it on a slide and stain with dilute carbol-fuchsin. In typical cases this is a conclusive test—the vibrios are found in almost pure culture arranged

in swarms all pointing the same way like fish in water ; but frequently microscopical examination furnishes no certain evidence. Microscopical examination should always be supplemented by sowing cultures with traces of the stools.

Very pretty microscopical preparations can be made by double staining the film by Gram's method using dilute carbol-fuchsin as a counterstain : the cholera vibrio is red, and the gram-positive organisms violet.

Dunbar's method.—Dunbar applies the phenomenon of agglutination to the detection of the vibrios in the stools. Prepare two hanging-drop cultures with a trace of the suspected material diluted in a drop of peptone water, and add to one a drop of an agglutinating serum. On microscopical examination, the vibrios are motile in the preparation to which no serum was added and non-motile and agglutinated in the other. Whether the method be reliable or no, the technique certainly requires much care.

Staining of sections.—Sections of the intestine are best stained by Nicolle's tannin method.

B. Isolation.

Stools.—The method originally employed consisted in isolating the organism from the stools by means of gelatin or agar plates ; but the plates are very often overgrown with other organisms so that the vibrio cannot be isolated. The following method is preferable.

Metchnikoff's method.—1. Prepare a number of tubes of gelatin-peptone-salt solution (p. 33), and after sowing them with a trace of the suspected stool incubate them at 37° C.

2. After 3 or 4 hours the tubes will be cloudy and in about 7 hours a thin pellicle will have formed on the surface of the medium. Examine a trace of the film under the microscope : as a rule the vibrio will not be found in pure culture but mixed with various other organisms.

3. To obtain a pure culture sub-cultivate a trace of the pellicle in another tube of the gelatin-peptone-salt solution, incubate for 6 or 7 hours and if necessary (after microscopical examination of a film from the pellicle) sow another tube in the same way ; it is however usually sufficient to plate on agar after the first sub-cultivation.

Liquefy a tube of agar and pour the medium into a Petri dish, allow it to set and then sow surface stroke cultures with a trace of the material from the pellicle. Incubate at 37° C. After a few hours, small delicate transparent or opalescent but never opaque colonies are visible which can be picked off after about 8 hours' incubation. The whole process of isolation thus takes only about 15 hours.

Gelatin plates may also be prepared at the same time as the agar plates and an examination of them subsequently will furnish a clue to identification.

[*Note.*—Instead of the peptone-gelatin medium, ordinary peptone water is very commonly used for the isolation of the cholera vibrio and Ottolenghi has recently suggested bile as an "enrichment" medium for the same purpose.]

Water. (Metchnikoff's method.) Recommended.—1. Prepare a series of conical flasks of 250 c.c. capacity or thereabouts. Measure 200 c.c. of water into each and make a mark on the glass with a diamond.

2. To each flask add the following solution :

| | | | | | | | | | |
|-------------------------|---|---|---|---|---|---|---|------|---------------------------|
| Water, - | - | - | - | - | - | - | - | 50 | c.c. |
| Peptone (Chapoteaut), - | - | - | - | - | - | - | - | 2 | grams. |
| Common salt, - | - | - | - | - | - | - | - | 2 | " |
| Gelatin, - | - | - | - | - | - | - | - | 4 | " |
| Solution of soda, - | - | - | - | - | - | - | - | Q.S. | to make faintly alkaline. |

Sterilize in the autoclave.

3. To the contents of each flask add 150 c.c. of the water under examination (that is, up to the mark on the flask) and incubate at 37° C. If the water should contain vibrios a thin pellicle will form on the surface of the liquid in about 8–10 hours. A trace of this film may be examined microscopically and one or two sub-cultures in series can be made in the gelatin-peptone-salt medium [or in peptone-water]; and if need be the organism can be isolated on agar in the manner described above.

2. Identification.

Having isolated a vibrio from the excreta or from water it is then necessary to identify the organism, because there are a number of vibrios which must be regarded as harmless saprophytes. Numerous species of vibrios have been found in different waters by Metchnikoff, Blachstein, Sanarelli,—the last-named observer has described no less than 32 species in the Paris water.

There is at present no known characteristic which is pathognomonic of the cholera vibrio, and when vibrios are found in water in the absence of any epidemic of cholera it may be impossible to identify them. The following are generally regarded as the classical characteristics of the cholera vibrio:—

1. The appearances presented in gelatin stab and plate cultures, p. 493.
2. The presence and the number of flagella, p. 492.
3. The nitroso-indol reaction in peptone-water cultures, p. 494.
4. The virulence for guinea-pigs (choleraic peritonitis), p. 489.
5. The immunity reaction, p. 499.
6. Agglutination by an anticholera serum and the occurrence of Pfeiffer's phenomenon, p. 500.

Attention has already been drawn in the course of this chapter to the lack of specificity and constancy of these characters; the most reliable is the agglutination reaction with the specific serum. A better means of identifying the cholera vibrio will perhaps consist in feeding young rabbits on the suspected vibrio either alone or mixed with ancillary micro-organisms. It seems probable that the application of the "fixation of the complement" reaction may be of considerable use in the identification of vibrios.



FIG. 242.—Vibrio of Finkler-Prior. Stab culture in gelatin (5 days).

The Vibrio of Finkler-Prior.

This vibrio was discovered by Finkler and Prior in the stools of a man suffering from acute enteritis. It was found again by the same observers in the stools of persons infected with cholera nostras, and it is possible that this was the organism found by Ruete and Enoch in the stools of a woman suffering from a fatal attack of diarrhoea.

The vibrio which Rommelaer took to be the Finkler-Prior vibrio really belongs to the group of the true cholera vibrios.

Experimental inoculation.—When inoculated intra-peritoneally into a guinea-pig the Finkler-Prior vibrio sets up a fatal peritonitis.

A fatal infection can be produced in pigeons by inoculating the organism into the pectoral muscle. In man the consumption of an agar culture of the vibrio after the contents of the stomach have been made alkaline produces slight intestinal disturbance (Metchnikoff).

Microscopical appearance.—Microscopically the Finkler-Prior vibrio is similar to the cholera vibrio but the former is slightly swollen in the centre and tapered at the ends. The two organisms give the same staining reactions and both are gram-negative.

The Finkler-Prior vibrio is motile and has a single flagellum.

Cultural characteristics.—Cultures of the Finkler-Prior vibrio resemble those of the cholera vibrio. The former liquefies gelatin more rapidly and does not form a bubble of air on the surface of the liquefied portion; it coagulates milk.

Biological properties.—The Finkler-Prior vibrio produces indol but only traces of nitrites. The nitroso-indol reaction is positive but only slightly marked and slowly produced (several days).

The Vibrio of Deneke.

This vibrio was isolated by Deneke from an old cheese. Morphologically, it is similar to the cholera vibrio and in gelatin plate cultures the appearance of the colonies of the two organisms may be identical. It liquefies gelatin rather more quickly than the cholera vibrio but less rapidly than the Finkler-Prior vibrio.

Guinea-pigs die as the result of intra-peritoneal inoculation of the vibrio (Hueppe, Metchnikoff); the organism is also pathogenic for pigeons (Kasanky, Metchnikoff). In man, infection with the organism causes diarrhoea (Metchnikoff).

Deneke's vibrio produces indol but very little nitrites. The cholera-red reaction is inconstant and very poorly marked.

Vibrio Metchnikowi.

(Vibrion avicide.)

The Metchnikoff vibrio was discovered in Odessa by Gamaléia, in a disease of fowls of which it is the cause. The disease is characterized by weakness, drowsiness and diarrhoea: *post mortem*, the alimentary canal is hyperæmic and the small intestine contains a yellowish-grey liquid which may be blood-stained; the vibrio is found in very large numbers in this fluid. As a rule, the organism does not gain access to the blood stream, though in young fowls affected with the disease it may be isolated from the blood.

Experimental inoculation.—Guinea-pigs are more susceptible to the Metchnikoff vibrio than to the cholera vibrio; intra-peritoneal and sub-cutaneous inoculation and ingestion—even without previous alkalization of the gastric contents—all lead to a fatal result.

The Metchnikoff vibrio kills young fowls whatever the channel of infection: simple ingestion alone is fatal. Adult birds are much less susceptible and cannot be infected by feeding. Pigeons though very susceptible to sub-cutaneous or intramuscular inoculation resist infection when fed with the organism.

Ingestion of the vibrio is harmless to man.

Microscopical appearance.—Morphologically the Metchnikoff vibrio is similar to the cholera vibrio: it is motile and has a single flagellum; sometimes spirals of 4 or 5 turns are seen.

Cultural characteristics.—The Metchnikoff vibrio grows on all the ordinary media and the growths are similar to those of the cholera vibrio. On potato, it grows more abundantly than the cholera vibrio and forms a yellow-brown streak. Cultures in milk ultimately become very acid and the casein is coagulated about the eighth day.

Biological properties.—The Metchnikoff vibrio produces indol and nitrites in peptone solutions and gives a very marked nitroso-indol reaction. Guinea-pigs, pigeons and fowls can be immunized by the inoculation of cultures killed by heat at 120° C.

CHAPTER XXXIII.

PFEIFFER'S INFLUENZA BACILLUS. THE HÆMOGLOBINOPHILIC BACILLI. THE BACILLUS OF WHOOPING COUGH.

Introduction.

Section I.—Experimental inoculation, p. 505.

Section II.—Morphology and cultural characteristics, p. 506.

Section III.—Biological properties, p. 508.

1. Vitality and virulence, p. 508. 2. Toxin, p. 508. 3. Immunity and serum therapy, p. 508. 4. Agglutination, p. 509. 5. Secondary infections and ancillary micro-organisms, p. 509.

Section IV.—Detection and isolation of the bacillus, p. 510.

The hæmoglobinophilic bacilli.

1. Pfeiffer's pseudo-influenza bacillus and similar organisms, p. 510. 2. The bacillus of acute contagious conjunctivitis, p. 510. 3. The bacillus of sub-acute conjunctivitis, p. 511.

The bacillus of whooping cough, p. 511.

THE *Bacillus influenzae* was discovered by Pfeiffer whose investigations were subsequently confirmed by Weichselbaum, Huber and others.¹

Influenza is a disease peculiar to man. Pfeiffer's bacillus is found in the sputum, nasal mucus and respiratory passages of those suffering from the disease.

The organism may set up foci of broncho-pneumonia in the lung and may also be the cause of some of the sequelæ of the disease: pleurisy, meningitis, and peritonitis (Meunier). The bacillus may still be present in the sputum some weeks after all symptoms of the disease have disappeared and for an even longer time in chronic lesions of the lung—*e.g.* tuberculosis and other conditions.

The symptoms point to influenza being an intoxication rather than a generalized infection and Pfeiffer was never able to isolate the organism from the blood stream. On the other hand Meunier found Pfeiffer's bacillus in the blood in four out of eight cases of the disease examined by him during life and Ghedini during an epidemic of influenza isolated the organism from blood taken from the bend of the elbow (64 out of 100 cases) and from material obtained by puncture of the spleen during the febrile attack (57 out of 100 cases). *Post mortem*, Rosenthal found the bacillus in the blood of the heart in all the fatal cases he examined.

Pfeiffer's bacillus has not been found in by any means all cases of clinical influenza, many of which are due to infection with the *Micrococcus catarrhalis*. the *Pneumococcus* and possibly with other organisms. Pfeiffer failed to isolate the bacillus in the 1899 epidemic, and in a very severe epidemic at Rennes

¹ The micro-organism found by Canon and Bruschetti in the blood of persons suffering from influenza differs essentially from Pfeiffer's bacillus in that it is a small streptococcus which grows well on ordinary media and is pathogenic to rabbits.

in 1897-8 Besson only found the organism in 80 per cent. of cases investigated. Achalme, Rosenthal, Bezançon, and others have reported similar observations.

Again, Pfeiffer's bacillus or an organism like it has been found in healthy persons as well as in cases of whooping cough, broncho-pneumonia, etc.

Relying on these negative observations many authors have raised a doubt as to the specific relationship of Pfeiffer's bacillus to influenza. Rosenthal, for instance, comes to the conclusion that "the hæmophilic cocco-bacillus (or bacillus of Pfeiffer) is a micro-organism commonly found among the pathological flora of the lung, and is not the bacillus which causes influenza." But the known persistence of Pfeiffer's bacillus in chronic lesions of the lung offers quite a satisfactory explanation of the occurrence of the organism among the flora of phthisical cavities, tuberculous bronchitis, etc., and is in no way inconsistent with the specific relationship of the bacillus to influenza. Further, there is no apparent reason why, under certain circumstances, Pfeiffer's bacillus should not live as a saprophyte in the human tissues: it is well known that the pneumococcus, the diphtheria bacillus and other organisms are frequently found under such conditions, and no question is ever raised as to the specific relationship of these organisms to their respective diseases. Again new hæmophilic micro-organisms similar to or identical with Pfeiffer's bacillus are being constantly described, e.g. the organisms found by Jochmann and Moltrecht in whooping cough, by Wolff in rats, and by Friedberger in dogs. Hence, it would appear that there is a group of hæmophilic micro-organisms, of which Pfeiffer's bacillus is the type, which inhabit for preference the respiratory passages but exhibit very divergent pathogenic properties.

Ancillary micro-organisms.—In influenza, particularly in the pulmonary lesions, Pfeiffer's bacillus is frequently accompanied by other pathogenic organisms, the more common being pneumococci and various streptococci. Reference will be made to these associated micro-organisms later but meanwhile it may be said that they largely determine the severity of the disease.

SECTION I.—EXPERIMENTAL INOCULATION.

As a result of his observations, Pfeiffer came to the conclusion that with the exception of monkeys the lower animals are immune against Pfeiffer's bacillus. This natural resistance may, however, be overcome by experimental methods.

Monkeys.—The inoculation of a pure culture of Pfeiffer's bacillus, or of sputum from cases of influenza, into the trachea, lung or nasal fossæ of monkeys is followed by a disease with symptoms similar to those of influenza in man. As a rule the animal recovers. In one fatal experiment, the pulmonary lesions were very like those seen in the human disease; the bacillus was found in this case in small numbers in the blood, bronchial secretions, and pulmonary mucus (Pfeiffer).

Laboratory animals.—Rats, pigs, cats, dogs, and pigeons are absolutely immune.

Rabbits.—The inoculation of large doses of pure cultures into the ear vein of a rabbit is sometimes fatal. Two or three blood-agar cultures emulsified in broth should be used. Under these conditions the organism does not generally multiply in the tissues but the animal dies from the effects of the soluble products inoculated at the same time as the organism.

This, and the fact that cultures killed with chloroform are equally fatal, tends to show that death is the result of an intoxication and not of an infection. Pfeiffer never obtained in any species of animal but monkeys "a multiplication of the inoculated bacilli, that is, a true infection."

It is nevertheless possible to produce an infection in rabbits. Thus, Meunier and also Elmassian produced a fatal infection in rabbits by intra-

venous inoculation and were able to demonstrate a multiplication of the bacilli in the blood and in the pulmonary and renal lesions.

Kruse produced sub-cutaneous abscesses and found living bacilli in the pus. Slatineano, and Delius and Kolle infected rabbits by intra-peritoneal inoculation. Cantani, Slatineano, and Martin, set up a fatal disease by inoculating small doses of culture into the brain.

Mixed infections.—Rosenthal inoculated a mixture of Pfeiffer's bacillus and a non-virulent staphylococcus aureus into rabbits' lungs: the animals died "of pulmonary congestion generally accompanied by septicæmia." Jacobson produced a fatal infection accompanied by generalization of the bacillus by inoculating rabbits intra-venously with a mixture of streptococci and Pfeiffer's bacillus.

Guinea-pigs.—Guinea-pigs are almost insusceptible but can be infected by intra-peritoneal inoculation of very virulent cultures (Delius and Kolle, Elmastian, Cantani and others).

Mice.—Mice die from toxæmia after intra-peritoneal inoculation of large doses of culture. Infection may also be produced by intra-peritoneal inoculation of small doses of virulent cultures, or by mixing the bacillus with a sterilized culture of streptococci (Jacobson).

SECTION II.—MORPHOLOGY.

1. Microscopical appearance.

Pfeiffer's bacillus is a very small rod-shaped organism with rounded ends, having practically the appearance of a cocco-bacillus. It is one of the smallest visible micro-organisms, is non-motile, and occurs singly or arranged in small chains composed of two to four bacilli. In sputum the bacilli are often seen massed together in large numbers. The organism is sometimes found within the leucocytes. In cultures, it is a little larger and longer than in sputum.



FIG. 243.—Pfeiffer's bacillus—Sputum—Dilute carbol-fuchsin. (Reich. oc. IV, obj. λ th.)



FIG. 244.—Pfeiffer's bacillus. Film from a blood-agar culture. Dilute carbol-fuchsin. (Reich. oc. IV, obj. λ th.)

Klein lays stress upon the frequency with which long strepto-bacillary filaments and bacilli with a central vacuole are seen in cultures. He has also noticed involution forms: long sinuous bacilli sometimes looking like a tangled mass of filaments, as well as large oval or club-shaped bacilli.

Staining reactions.—Pfeiffer's bacillus does not stain very readily with the basic aniline dyes and is gram-negative. The best method is to stain with dilute carbol-fuchsin for about 10 minutes. Carbol-methylene blue, carbol-thionin or Nastikow's violet may also be used. Staining may be accelerated by heating the dye.

Sections.—Sections through influenzal broncho-pneumonic patches contain numerous bacilli. Pfeiffer recommends the following method for staining the bacilli in sections :

Fix in alcohol, embed in celloidin (paraffin is better, Besson) stain for half an hour in dilute carbol-fuchsin, differentiate for a few seconds in absolute alcohol slightly acidified with acetic acid—the deep red colour of the sections is now changed to a uniform pinkish-violet tint—clear in clove oil and xylol and mount in balsam. The bacilli are stained deep red and the ground work a pale pink.

2. Cultural characteristics.

Conditions of growth.—Pfeiffer's bacillus does not grow on the ordinary media : for its cultivation outside the body media containing blood, serum, or hæmoglobin must be used. It is strictly aerobic and grows at temperatures between 26° and 42° C., the optimum being 37° C.

When an emulsion of sputum containing Pfeiffer's bacillus is sown on agar (p. 192) a scanty growth of the organism is generally obtained but sub-cultures on the same medium fail. The sputum apparently supplies the substances necessary for the growth of the primary culture ; but for sub-cultures blood-agar must be used. It is important that the agar should be neutral or only just alkaline, for even a slight excess of alkali may give a negative result.

Characters of growth. Blood-agar.—Agar to which blood has been added is the best medium for growing Pfeiffer's bacillus. To prepare the medium, liquefy a tube of agar and pour the contents into a Petri dish : when set spread a large drop of blood in as thin a layer as possible over the surface. Agar slopes may be treated in the same way. Human blood or the blood of rabbits or pigeons, collected of course aseptically, gives the best results. Blood-agar prepared according to Bezançon's directions (p. 53) is equally suitable.

Surface cultures on blood-agar sown with an emulsion of sputum and incubated at 37° C. for 24–48 hours give a copious growth of very small, delicate colonies like minute dew drops, visible only with a lens : the colonies never become confluent. A colony here and there may attain the size of a pin's head.

FIG. 245. — Pfeiffer's bacillus. Single colonies on blood-agar (48 hours at 37° C.). × hand lens.

Hæmoglobin-agar.—Huber relying on Pfeiffer's observation that hæmoglobin is the constituent in blood essential for the growth of the bacillus prepared an hæmoglobin medium.

Huber used Hommel's commercial hæmoglobin : this liquid, deep red in colour, was made strongly alkaline with potash solution to prevent coagulation during heating and then sterilized at 100° C. The product was added to sterile melted agar cooled to 50° or 60° C. in sufficient quantity to make the agar deep red in colour. The tubes were then sloped and allowed to set. The medium is not very satisfactory, and the same remark is applicable to Nastikow's method of adding yolk of egg to agar.

It is better to use a 1 per cent. aqueous solution of commercial hæmoglobin and to sterilize by filtration through a porcelain bougie (Achalmé, Rosenthal).

Liquid media.—In broth containing pigeons' blood Pfeiffer's bacillus gives rise to delicate whitish flakes but the growth is not particularly characteristic. A better cultivation is obtained by using rabbit serum into which a certain amount of hæmoglobin has been allowed to diffuse by leaving the serum in contact with the clot (Rosenthal).

Pfeiffer's bacillus does not grow on glycerin-agar. The cultures which were

obtained by Kitasato and by Bruschetti and Canon were not cultures of Pfeiffer's bacillus.

Ascitic fluid media are not, as a rule, of much use for growing Pfeiffer's bacillus though very suitable for Elmassian's micro-organism.

SECTION III.—BIOLOGICAL PROPERTIES.

1. Vitality and Virulence.

Pfeiffer's bacillus is very sensitive to heat and drying. In sputum which is kept moist the organism retains its vitality for 14 days; but if allowed to dry at ordinary temperatures, the organism is killed in 36 hours. Desiccation at 37° C. sterilizes cultures of the bacillus in 2 hours and at ordinary temperatures in 24 hours.

In cultures on blood-agar, the bacillus lives for a week to a fortnight; and by sub-cultivating on this medium every 4 or 5 days it can be kept alive for several months. In a collodion sac in the peritoneal cavity of a rabbit the organism lived for nearly 2 months (Dujardin-Beaumetz).

The virulence of Pfeiffer's bacillus is subject to considerable variation. By mixing the organism with streptococci and passing the mixture through mice the virulence can be raised for a short period but not for long.

2. Toxin.

Cultures killed with chloroform or heat are toxic. Heated cultures inoculated into the cerebro-spinal fluid of rabbits killed the animals in 2-3 hours (Martin and Dujardin-Beaumetz).

Slatineano prepared an endo-toxin as follows:

Cultures on blood-agar 24 hours old, either living or killed by heat at 55° C. were made into an emulsion with normal saline solution, centrifuged and the deposit dried. 0.25 gram of dried bacilli were mixed with 10 c.c. of a mixture of equal parts of distilled water and normal horse serum, left in the ice chest for 12 hours and then centrifuged.

The supernatant liquid, in doses of 0.045 c.c., inoculated into the brain of guinea-pigs, proved fatal in 6-10 hours, and when given in quantities of 5 c.c. into the peritoneal cavity the animal died in a few days.

3. Immunity. Serum therapy.

Kolle and Delius failed to immunize animals against Pfeiffer's bacillus but Slatineano, Cantani, and Latapie, obtained more promising results.

Cantani inoculated guinea-pigs sub-cutaneously with increasing doses of very virulent cultures on blood-agar sterilized at 56° C. One guinea-pig was inoculated with 181 cultures over a period of 4 months. The animals were then tested by inoculating many times the minimal lethal dose into the peritoneal cavity. Many of the animals did not survive the immunizing process, but those which did proved to be highly immune and were able to resist the intra-peritoneal inoculation of 100 lethal doses. The serums of the immunized animals exhibited prophylactic properties in different degrees: the best results were obtained when the test animal was inoculated with the serum of an immunized animal mixed with a virulent culture.

Latapie immunized a goat by inoculating it first with dead then with living cultures of a strain of Pfeiffer's bacillus isolated from a case of influenza; several inoculations were given and the immunizing process was extended over a year. The animal was bled 1 month after the last inoculation, and the serum was found to be capable of protecting guinea-pigs against two or three fatal doses of the bacillus, provided that it was inoculated in doses of 1-3 c.c. either sub-cutaneously several hours before, or intra-venously a few hours before, the test inoculation.

4. Agglutination.

Pfeiffer's bacillus is not specifically agglutinated by the serum of patients suffering from influenza and in whose sputum the organism is present (Meunier).¹

The serum of immunized animals agglutinates the bacillus in dilutions of 1 in 200 to 1 in 500 (Cantani).

5. Secondary infections—Ancillary micro-organisms.

In persons suffering from influenza certain micro-organisms are able to develop side by side with Pfeiffer's bacillus² and produce complications of the original disease. The micro-organisms commonly found associated with Pfeiffer's bacillus are *streptococci*, *pneumococci*, *staphylococci* and *bacillus coli*. These micro-organisms appear to favour the development of Pfeiffer's bacillus and to facilitate its growth.

Grassberger has pointed out that in artificial cultures, in presence of the *staphylococcus aureus*, the colonies of Pfeiffer's bacillus grow to an unusually large size so that they become visible to the naked eye in 24 hours.

The colonies remain transparent, and nearly colourless or bluish, the centres being sometimes greyish in colour: they are almost confluent but their margins do not blend. These giant "influenza" colonies are seen lying in the hollows between the larger staphylococcal colonies: sub-cultivated alone on blood-agar (without the staphylococci) they give rise to colonies of normal appearance which retain their vitality longer than usual.

Pfeiffer's bacillus is less sensitive also to the reaction of the culture medium when grown symbiotically with the staphylococcus, so that it will then grow on quite markedly alkaline blood-agar.

The various staphylococci, and in a lesser degree the colon bacillus, the typhoid bacillus, the diphtheria bacillus, and streptococci all exhibit this ancillary influence.

The influence of these organisms on Pfeiffer's bacillus seems to depend upon the action of certain substances secreted by them or to some change induced in the medium as a result of their growth. Thus, if a 24-hour agar culture of a staphylococcus be sterilized in the autoclave, poured into a Petri dish, and sown with Pfeiffer's bacillus after smearing the surface with blood, the organism will grow in the form of the large colonies referred to above (Rosenthal).

This fact can be easily demonstrated in the following manner: Sow a culture of Pfeiffer's bacillus all over the surface of a blood-agar medium and after incubating for 3 or 4 hours at 37° C. to evaporate the excess of moisture and to get rid of bubbles, sow a narrow stroke culture of the staphylococcus on the surface or make two or three punctiform stabs. On incubation at 37° C. Pfeiffer's bacillus will form giant colonies like satellites around the staphylococcal colonies.³

Rosenthal suggests that this ancillary action of the staphylococcus might be applied in cases where search for Pfeiffer's bacillus has yielded doubtful results: thus if tubes sown with sputum or blood remain sterile after incubating for 24 hours, he suggests that a staphylococcus might be sown in a narrow streak on the culture medium in the hope that it might stimulate the latent bacillus.

¹ It must be remembered that normal human serum and the serum of normal animals will agglutinate Pfeiffer's bacillus in dilutions of 1 in 10 to 1 in 20.

² In 6 only out of 30 cases of influenza studied by Grassberger was Pfeiffer's bacillus found in pure culture.

³ The *Micrococcus prodigiosus* has a similar effect, but the cultures of this coccus must be sterilized by heating for 20 minutes at 60° C., since sterilization in the autoclave destroys the action (Luerssen).

According to Rosenthal, Pfeiffer's bacillus exerts a reciprocal ancillary action on the pneumococcus: thus after sub-cultivating a pure culture of the latter on blood-agar a few times the organism dies out, but if it be mixed with Pfeiffer's bacillus the pneumococcus may be sub-cultivated almost indefinitely on blood-agar.

SECTION IV.—THE DETECTION AND ISOLATION OF PFEIFFER'S BACILLUS.

In cases of influenza Pfeiffer's bacillus occurs in the sputum and nasal mucus, and more rarely in the blood; for the purpose of demonstrating the bacillus it is best to examine the sputum. Pfeiffer lays stress on the somewhat characteristic appearance of the sputum—thick, purulent, greenish-yellow and generally inspissated in small compact masses: the bacillus lies between and within the pus cells. Microscopical examination should always be supplemented by cultivation. In sowing the sputum certain precautions are necessary.

Select a very solid portion of the sputum, and after washing it several times in sterile distilled water (Kitasato's method: p. 192) remove a fragment from the centre without introducing contaminations and sow it on the surface of blood-agar plates.

THE HÆMOGLOBINOPHILIC BACILLI.

1. The pseudo-influenza bacillus of Pfeiffer, distinguished from Pfeiffer's influenza bacillus by its rather larger size and by its property of forming filaments in culture, is now admitted by Pfeiffer and others to be identical with the latter organism as was suggested many years ago by Besson.

Grassberger's micro-organisms A and B and the hæmophilic cocco-bacillus of Rosenthal must also be regarded as identical with Pfeiffer's bacillus.

The bacillus found by Jochmann, Krause and Moltrecht in the sputum and in the broncho-pneumonic patches of cases of whooping cough, and known as the *B. pertussis* Eppendorf, should in the absence of further knowledge and if the description given by these observers be accepted also be considered as identical with Pfeiffer's bacillus.

Elmassian's bacillus has all the morphological characteristics of Pfeiffer's bacillus, but is highly pathogenic to guinea-pigs in which animals it produces a rapidly fatal septicæmia. Probably this organism is one of a group of hæmophilic micro-organisms closely related to Pfeiffer's bacillus. Friedberger's *B. hæmoglobinophilus canis* and the bacillus isolated by Wolff from the bronchial mucus of a rat which had died as the result of the inoculation of cholera toxin are members of the same group.

2. The bacillus of acute contagious conjunctivitis.

Acute contagious conjunctivitis is caused by a bacillus described by Weeks and Morax: the organism is very similar to Pfeiffer's bacillus.

Jundell thinks that the conjunctivitis due to Weeks' bacillus is possibly a localized influenza in the eye, and that the causal organisms in the two diseases are merely variants of one and the same species.

Experimental inoculation.—Weeks' bacillus is not pathogenic for animals when inoculated on the conjunctiva. In man, however, a trace of a culture smeared on the conjunctiva gives rise to an acute conjunctivitis.

Morphology.—The bacillus occurs as small very slender and very short rods, non-motile, arranged either singly or in chains of two or three bacilli, either free or within the leucocytes. In cultures, the bacillus often assumes an elongated form. It stains with the ordinary aniline dyes and is gram-negative.

Cultural characteristics.—The organism is aerobic and fails to grow or grows very feebly on the ordinary media, but on media containing blood or serum gives rise to a good growth. Growth only takes place at 37° C. The cultural characteristics are in every way similar to those of Pfeiffer's bacillus.

3. The bacillus of sub-acute conjunctivitis.

The organism described by Morax is a large diplo-bacillus, measuring 2–3 μ long and about 1 μ broad. It is non-motile and occurs singly or grouped in clumps or chains, it stains with the basic aniline dyes and is gram-negative. In the conjunctival secretions, the bacilli are free or intra-cellular.

Morax's bacillus is aerobic and grows only on media containing blood or serum. Cultures retain their vitality for a long time at 37° C., but are killed in 15 minutes at a temperature of 58° C.

A drop of culture placed in the conjunctival reflection in man sets up a typical conjunctivitis. The bacillus has no pathogenic action on the conjunctiva of animals.

THE BACILLUS OF WHOOPING COUGH (Bordet-Gengou).

Numerous micro-organisms have from time to time been isolated from the bronchial secretions of children suffering from whooping cough. These may be regarded as belonging to one of two types: (1) bacilli which only grow on media containing hæmoglobin and which must be considered as identical with Pfeiffer's bacillus, e.g. the organism isolated by Jochmann and Krause (p. 510); (2) bacilli which grow on ordinary media e.g. the bacilli isolated by Afanassiew, Vincenzi, Czaplewski and Henger, etc. In the case of none of these organisms has proof been adduced in support of their specific relationship to the disease.

Bordet and Gengou, on the other hand, have brought forward convincing arguments in favour of the specificity of an organism which they isolated from the sputum of cases of whooping cough. Its appearance and characteristics are as follows:

1. Morphology.—A small bacillus often assuming a cocco-bacillary form, staining more deeply at the ends than in the centre, gram-negative, occasionally intra-cellular and exhibiting pleomorphic features in liquid culture media.

2. Cultural characteristics.—The organism grows feebly and cannot be cultivated on the ordinary media either under aerobic or anaerobic conditions. It grows best on an agar medium made with a 1 per cent. glycerin-potato mash to which an equal volume of human or rabbit blood or serum (hæmoglobin is not essential) has been added.

Primary cultures are difficult to obtain and the growth is always very scanty, so scanty indeed as often to be invisible to the naked eye. By sub-cultivating after incubating for 48 hours at 37° C. a better growth is obtained, consisting of a narrow, whitish, slightly raised but distinctly visible streak which becomes thicker and whiter in subsequent sub-cultures. Growth is then easily obtained on ascitic-agar, serum-broth, blood-broth, etc.

3. Detection and isolation of the bacillus.—The bacillus of Bordet-Gengou should be sought for in the early stages of the disease when the fits of coughing first begin; at a later period its isolation becomes difficult or impossible on account of the numerous other organisms which have become mixed with it. To isolate the organism sow a fragment of the bronchial exudate, not mixed with saliva, on the surface of the special blood-potato-agar.

4. The following facts constitute the evidence upon which the organism is claimed to be the cause of the disease.

a. The bacillus of Bordet and Gengou is agglutinated by the serum of children who have recently recovered from whooping cough, though not in every case: it is however always agglutinated by the serum of an immunized horse, even in a dilution of 1 in 5,000.

b. The serum of children who have recovered from the disease always contains a specific immune body (*sensibilisatrice*) the presence of which was proved by Bordet and Gengou by the method of complement fixation.

c. The bacillus of Bordet and Gengou, when inoculated into the peritoneal cavity of a guinea-pig, causes the death of the animal from toxæmia: the endotoxin of the bacillus sets up necrosis. Klimenko failed to reproduce whooping cough in guinea-pigs and most laboratory animals: but in young dogs and in monkeys (*Cynocephalus*, *Macacus*, *Cercopithecus*) a disease characterized by fever, catarrh of the nasal and ocular mucous membranes, sneezing, and accompanied by a hoarse cough, without spasms but occasionally causing vomiting, followed infection by the bacillus whether produced by inoculation into the naso-pharyngeal cavities or by contagion. Young dogs often died of pneumonia after about 5 or 6 weeks and the bacillus was found in the laryngeal secretion and in the pulmonary foci.

CHAPTER XXXIV.

THE BACILLUS OF SOFT SORE.

Introduction.

Section I.—Experimental infection, p. 513.

Section II.—Morphology and cultural characteristics, p. 514.

Section III.—Biological properties, p. 515.

Section IV.—Detection, isolation and identification of the bacillus, p. 515.

THE bacillus of soft sore was discovered by Ducrey and more completely studied by Unna, Ch. Nicolle, Queyrat, Bezançon and others.

In pus from the chancre the bacillus is generally found in association with other organisms (*staphylococci*, *micrococcus tetragenus*, *bacillus cutis communis* of Ch. Nicolle and *gonococci*). The bacillus is found between the cells of the connective tissue of the dermis, but does not penetrate into the fixed cells of the tissues nor gain access to the vessels; when the lesion is healing numerous bacilli will be found in the leucocytes. The pus becomes less and less pathogenic as the sore cicatrizes.

The bacillus is present in pure culture in the bubo, but as a rule (92 times out of 100, Rille) cannot be detected on microscopical examination of the pus—the sterile pus of Strauss—though its presence there can be demonstrated by sowing cultures (Bezançon, Griffon and Le Sourd, Simon).

SECTION I.—EXPERIMENTAL INFECTION.

Man.—If a little pus from a chancre or a culture of the bacillus be inoculated a typical soft sore is produced in the human subject. A first infection confers no immunity, and the sore is indefinitely re-inoculable time after time in the same individual.

Inoculation for experimental purposes should be made into the outer surface of the arm or into the thighs but not on to the abdomen below the umbilicus.

It is best to lightly scarify the epidermis over an area of 2 or 3 mm. with a sterilized needle charged with the virus; the skin should be scratched sufficiently deeply to draw a drop of blood. The site of inoculation should be protected from friction and from all source of contamination: the most convenient method of doing this, and one which allows of the lesion being watched, is to cover the part with a sterile watch-glass which can be held in position by a piece of gauze in the centre of which a hole is cut so that the glass is only covered at its edges; the gauze is fixed to the glass and to the skin with collodion. The whole is covered with a little wool and bandaged. The lesion commences to develop about the end of the first day and is characteristic about the fourth to the sixth day.

Animals.—Laboratory animals are immune but monkeys (*Macacus* and Bonnet monkeys) may be infected experimentally. Tomaszewski has successfully inoculated man with cultures from an experimental sore in a monkey.

SECTION II.—MORPHOLOGY.

1. Microscopical appearance.

The organism is a rather short bacillus with rounded ends measuring 0.5μ by 1.5 to 2μ . Two lateral notches are sometimes seen which give the organism a figure-of-eight appearance. In pus it occurs singly or in a chain composed

of three to twenty bacilli, and clumps may be formed of chains crowded one against another. The bacilli are generally free, but it is not uncommon to find them inside the polynuclear leucocytes. In scrapings from some soft sores the bacillus does not show its ordinary characteristics but assumes the form of a coccus (Queyrat).

In cultures on blood-agar the bacilli occur singly or collected together in masses or in short chains: in liquid serum they form long wavy chains arranged like a skein of silk (streptobacilli): in the liquid at the bottom of blood-agar tubes the bacilli are more slender and the chains much longer.

FIG. 246.—Bacillus of soft sore. Scraping from chancre. Nicolle's stain.

**Staining reactions.**—The bacillus of soft

sore is easily stained with the basic aniline dyes, but in the majority of cases only the ends take up the dye leaving the centre unstained (shuttle-shaped bacilli). The bacillus is gram-negative.



FIG. 247.—Bacillus of soft sore. Film from a culture on blood-agar. (After Bezançon, Griffon and Le Sourd.)



FIG. 248.—Bacillus of soft sore. Film from a liquid serum culture. (After Bezançon, Griffon and Le Sourd.)

(a) **Pus and cultures.**—Pus and cultures should be stained with carbol-thionin, carbol-blue or carbol-violet and examined in water or balsam.

Krefting recommends the following solution:

| | | | | |
|---|---|---|---|---------|
| 5 per cent. solution of boric acid in water, | - | - | - | 16 c.c. |
| Saturated aqueous solution of methylene blue. | - | - | - | 20 " |
| Distilled water, | - | - | - | 24 " |

Queyrat recommends the following mixture for smear preparations:

| | | | | |
|---|---|---|---|-----------|
| Carbol-fuchsin, | - | - | - | 10 drops. |
| Saturated aqueous solution of methylene blue, | - | - | - | 7 " |
| Distilled water, | - | - | - | 20 c.c." |

(b) **Sections.**—The method recommended for staining sections is Nicolle's tannin method (p. 217). Stain in Kühne's carbol-blue then treat for a few seconds with 10 per cent. tannin solution, wash in water, then in alcohol, clear in clove oil and xylol and mount in balsam.

2. Cultural characteristics.

Conditions of growth.—The bacillus of soft sore does not grow on the ordinary media.

It would seem that Petersen was able occasionally to grow the bacillus on serum-agar but his investigations have not been confirmed. Istamanoff and Akspiantz as well as Lenglet employ macerations of human skin solidified with agar, but their technique is obscure and their results unconvincing. The cultivation of the bacillus has been made practicable by the investigations of Bezançon, Griffon and Le Sourd.

The most suitable medium is the rabbit-blood-agar of Bezançon and Griffon (p. 53) and after that liquid rabbit-serum. All attempts to grow the organism on the ordinary media failed even after acclimatizing the bacillus by sub-cultivating it on a series of blood-agar tubes.

The bacillus is aerobic and grows at 37° C.

Blood-agar.—After sowing surface cultures freely with pus from the sore and incubating at 37° C. for 24 hours colonies appear which are "rounded, raised, lustrous, and attain their maximum size in 48 hours; they are then greyish opaque and about 1–2 mm. in diameter." When the growth is removed for microscopical examination it has a tendency to slip away from the needle and is difficult to break up on a slide.

Sometimes the colonies only appear after incubating for 48 hours and are few in number. The growth is more abundant in sub-cultivations, in which the colonies are very numerous and may attain the size of a pin's head, but they never coalesce to form a continuous layer.

Rabbit-serum.—Growth is poorer in liquid serum than on the above medium. The serum becomes slightly turbid and shows a few little flocculi floating in it.

SECTION III.—BIOLOGICAL PROPERTIES.

Vitality and virulence.—Pus from the sore will remain virulent for some time if kept away from the air; Ricord obtained positive results after inoculating pus 17 days old. The virulence is preserved equally well in urine, water, vaginal mucus, etc. Drying at ordinary temperatures seems to destroy the virulence of the pus in 24–36 hours; heating for 18 hours at 37° C. or for an hour at 42° C. also destroys the virulence (Aubert), but a temperature of –16° C. has no effect on it (Jullien). The bacillus is quickly destroyed by weak antiseptic solutions and by acids and alkalis.

In cultures on blood-agar the bacillus retains both its vitality and its virulence for a very long time: sub-cultures sown from cultures kept in the incubator at 37° C. for more than 3 weeks give positive results, and after eleven sub-cultures on blood-agar the bacillus will still give rise to a soft chancre in man. But in cultures on liquid serum the vitality of the organism is of short duration (Bezançon, Griffon and Le Sourd).

SECTION IV.—DETECTION ISOLATION AND IDENTIFICATION OF THE BACILLUS.

To determine the presence of the bacillus in the tissues microscopical examination should be supplemented by cultivation experiments and by inoculation.

(a) **Microscopical examination.**—Scrapings from the sore.—Wipe away the pus from the surface of the sore, lightly scrape the base of the ulcer with a strong platinum needle and spread the material on slides, taking care not to

treat the preparation roughly otherwise the chains will be broken up. Dry, fix and stain (*vide ante*).

Sections.—Fix small pieces of skin in acid perchloride, harden in alcohol and embed in paraffin. Stain according to the method given above.

(b) **Cultures.**—Sow tubes of blood-agar with pus from the chancre or bubo, using a liberal amount of material. To collect the material for sowing cultures allow the pus to accumulate beneath a dry dressing, which should be applied to the sore after disinfecting the latter with tincture of iodine.

(c) **Inoculations.**—Inoculation if made at all should be made on the man infected with the chancre under investigation (p. 513). In this way the nature of the sore may in some cases be determined, for if the inoculation "take," the experiment indicates that the chancre is a soft sore. A positive result does not however exclude the possibility of a co-existent syphilitic infection; and soft sores are often due to a mixed infection with the bacillus of soft sore and the *Treponema pallidum*.

CHAPTER XXXV.

BACILLUS ANTHRACIS.

Introduction.

Section I.—The experimental disease, p. 518.

1. Susceptible and immune animals, p. 518.
2. Methods of inoculation, p. 519.
3. Symptoms and lesions in experimental animals, p. 519.

Section II.—Morphology, p. 520.

1. Microscopical appearance and staining reactions, p. 520.
2. Cultural characteristics, p. 524.

Section III.—Biological properties, p. 525.

1. Viability and resistance, p. 525.
2. Virulence, Attenuation, Pasteur's vaccination, p. 527.
3. Toxin, p. 529.
4. Vaccination with toxin, p. 530.
5. Serum therapy, p. 530.
6. Agglutination, p. 533.

Section IV.—Detection, isolation and identification of the anthrax bacillus, p. 533.

- Distribution of the bacillus, p. 533.
- Methods of examination, p. 534.
- Examination of carcasses dead of anthrax, p. 534.
- Isolation of the bacillus from soil, p. 535.

THE anthrax bacillus is the cause of anthrax in man and the lower animals.

In man three forms of the disease are commonly recognized viz. **malignant pustule**, **pulmonary anthrax** or **wool sorter's disease**, and **intestinal anthrax**. These three clinical types correspond to the three channels of infection. The skin infection (malignant pustule) follows contamination of an abraded surface when handling the hides or flesh of animals dead of the disease. [In England malignant pustule is seen chiefly among the hide porters at the various ports, and in the tanneries of South London.] Infection of the respiratory passages results from the inhalation of dust containing the spores of the bacillus; [it is the characteristic infection in the wool-combing sheds of Yorkshire] and is hence sometimes known as the Bradford disease. Intestinal anthrax is very uncommon; when it occurs it is due to the consumption of meat from anthrax-infected animals.

In the lower animals the disease is variously designated: the commonest description being "**splenic fever**" or "**splenic apoplexy**"—of sheep and cattle. Anthrax in cattle and pigs in Brazil is known as *garotilho*.

Infection of domestic animals takes place, as a rule, *via* the alimentary canal by means of food contaminated with the spores of the bacillus. When anthrax-infected carcasses are buried the bacilli which are very numerous in the blood form spores. These are brought to the surface in worm casts and being washed over the ground by rain are subsequently taken up by animals grazing over the infected area, and should the epithelial lining of the alimentary canal be abraded by thorns, splinters of wood or other similar substance present in the food-stuff, the spores find a point of entry into the tissues and multiplying under the favourable conditions of their environment give rise to the disease (Pasteur). In Brazil, the carcasses of anthrax-infected animals are devoured by vultures, and the latter disseminating the spores in their excreta are, according to Marchoux and Salimbeni, the chief agents in the spread of *garotilho*.

In cases of spontaneous infection in man and the lower animals it may be stated that the less severe the local reaction the more severe the subsequent septicæmia. Malignant pustule in man, where the most prominent feature is the external lesion, only exceptionally leads to death [—according to figures given by J. M. Legge the death rate from cutaneous anthrax is nevertheless about 24 per cent. in this country (61 deaths among 255 cases in six years)]. On the other hand in domestic animals the local reaction is almost *nil* (sometimes glosso-anthrax), and death usually supervenes.

SECTION I.—THE EXPERIMENTAL DISEASE.

1. Susceptible and immune animals.

1. Sheep.—In sheep the disease runs a very rapid course : death often takes place suddenly following an attack of hæmoglobinuria. Generally speaking this species is highly susceptible to infection both by sub-cutaneous inoculation and by ingestion ; Algerian sheep however are immune (Chauveau).

2. Rodents.—Mice, guinea-pigs and rabbits are very susceptible to sub-cutaneous inoculation but are less easily infected by feeding.

Rats generally show a higher degree of immunity. White rats are in most cases immune but the immunity is not absolute and is subject to great variation. Young rats are more susceptible than adults of the species.

Rats may be inoculated with anthrax bacilli several times without infecting them though it is always possible that a further inoculation may produce the disease (Straus). A virus virulent for adult rats can be obtained by passage through young white rats (Metchnikoff). Overfeeding lowers the resistance of the rat and renders it susceptible to infection (Charrin and Roger). Feeser believes the immunity to be more constant in animals fed on meat.

Behring, Metchnikoff and Roux, and Sawtchenko, have shown that the serum of white rats contains a *lysin* capable of dissolving the anthrax bacillus *in vitro*.

3. Bovine animals.—Cattle are very susceptible to infection through the intestinal canal but are more resistant to sub-cutaneous inoculation. When infected by feeding the animal is attacked with a blood-stained diarrhoea, colic, sweating and convulsions and dies after a few hours' illness.

4. Horses.—The horse is not often infected through the intestinal canal, though intestinal anthrax occurs as an epizootic among horses in Russia and in Corsica. [The epizootics of anthrax in Siberia are known as **Siberian fever**.] Horses are more susceptible than cattle to sub-cutaneous inoculation.

5. Pigs.—These animals are almost entirely immune to anthrax.

Carini has recorded the occurrence in Brazil of an anthrax infection of pigs accompanied by swelling of the cervical glands (*garotilho*), but has been unsuccessful in his attempts to reproduce the disease experimentally.

6. Carnivora.—As a rule these animals are only slightly susceptible to anthrax. Bears and cats seem more susceptible than other animals of this family. The fox is immune (Amler).

Dogs are naturally immune to anthrax [but spontaneous infection has been observed following upon the consumption of infected horse meat]. Sub-cutaneous inoculation generally results in the formation of an abscess in which active phagocytosis takes place so that the animal escapes a generalized infection. The immunity of the dog may be overcome by inoculating very large quantities of the virus into the veins, by the intra-venous inoculation of an emulsion of wood-charcoal, by extirpation of the spleen, etc. Young dogs readily succumb to intra-pleural inoculation (Nocard). A mad dog inoculated with 1 c.c. of a culture harmless to a healthy dog dies of anthrax in less than 24 hours. The virus thus

obtained is considerably increased in virulence and can be used for passage experiments in dogs (Martel).

7. Birds.—Fowls are naturally immune to anthrax. The insusceptibility of this species has however been overcome experimentally in several ways. Pasteur, for instance, succeeded in rendering fowls susceptible by keeping their legs in cold water at a temperature of 25° C.: Wagner obtained the same result by lowering the temperature by means of repeated inoculations of antipyrin: Canalis and Morpugo by experimenting while the animals were fasting, etc.

The pigeon is less highly immune than the fowl and readily succumbs to the inoculation of anthrax bacilli into the anterior chamber of the eye. Young pigeons are much more susceptible than adults.

A virus which has been passed through dogs readily kills pigeons (Martel). The virulence of the bacillus is also increased by passage through pigeons and after several such passages a virus is obtained which on sub-cutaneous or intra-muscular inoculation will kill a full-grown pigeon and even a fowl (Metchnikoff).

8. Cold-blooded vertebrata.—Batrachians are immune to anthrax. Gibier has, however, been able to infect frogs by keeping the inoculated animals in water at 35° C. Catterina succeeded in infecting newts.

Sabrazes and Colombot have shown that hippocampi (Lophobranchiata) are susceptible to anthrax. These animals kept under the normal conditions of their existence die a few days after the sub-cutaneous inoculation of 0·25 c.c. of a broth culture. Sabrazes and Colombot attribute this susceptibility to the absence of a spleen and the small number of leucocytes in the blood of hippocampi.

9. Invertebrata.—Slugs are naturally immune to anthrax (Kowalewsky), but Lode has succeeded in infecting them by keeping them at a temperature of 32° C. and inoculating them in the body cavity.

2. Methods of inoculation.

1. Sub-cutaneous inoculation.—Inject sub-cutaneously with the ordinary precautions a few drops of anthrax blood, or, better a few drops of a young broth culture of anthrax bacilli.

Broth cultures incubated at 37° C. for 2 or 3 days are more virulent than the blood with which they were sown, probably on account of the presence of antibodies in the anthrax-infected blood.

2. Ingestion.—Pasteur and Chamberland infected sheep with anthrax by mixing thorns and splinters of wood previously watered with spore-bearing cultures of anthrax with their food.

3. Intra-venous inoculation.—Inject a small quantity of a broth culture into a vein. Anthrax blood should never be used for intra-venous inoculation for fear of producing a fatal embolism.

4. Intra-muscular inoculation.—This method is sometimes used in the case of birds, the ordinary technique being adopted.

3. Symptoms and lesions in experimental animals.

The symptoms and lesions in the guinea-pig and rabbit after sub-cutaneous inoculation will be described, as these are the animals most commonly used for experimental purposes, and this the usual form of infection.

A. Symptoms. Local reaction.—Eight to fifteen hours after inoculation a small oedematous puffiness appears around the site of inoculation. The neighbouring glands then become swollen and the temperature rises 1° or 2° C.

General reaction.—For the first 24 or 30 hours in the case of the guinea-pig and for 30–50 hours in the case of the rabbit the animal shows no symptoms,

but later it becomes restless, the respiration is accelerated, and there is frequency of micturition; the animal then huddles itself up and becomes drowsy, the temperature falls to below normal (34° or 30° C.), coma supervenes and the animal dies in a few minutes.

B. Lesions. 1. Local lesion.—At the site of inoculation there is more or less œdema of the sub-cutaneous cellular tissue, the exudate is gelatinous, somewhat red, very poor in leucocytes and contains numerous organisms (gelatinous œdema). The neighbouring lymphatic glands are enlarged, ecchymosed, surrounded by an œdematous area and contain numerous bacilli.

2. The blood.—The bacilli appear in the blood about 15 hours after inoculation, and at the time of death the blood is literally swarming with them. The blood is very dark in colour and of the consistence of pitch; it coagulates slowly and does not become red on exposure to the air. There is an hyperleucocytosis, the red cells are deformed and in film preparations agglutinate in irregular masses. The veins are congested.

3. Internal organs.—The anthrax bacillus is a strict aërobie, and the anatomical characteristic of the disease is the presence of the bacilli in the blood capillaries. The parenchyma of the internal organs contains no bacilli unless the latter have reached there through rupture of the blood vessels. The glandular and epithelial cells are always found practically undamaged and, contrary to what occurs in other infections, lesions of degeneration are never seen.

The **spleen** is swollen and diffluent: it contains a veritable felting of bacilli.

Liver, lungs and glands.—The blood capillaries are engorged with bacilli while the epithelial cells are intact. In the bile a very few bacilli are sometimes found which have escaped from a ruptured blood vessel. In females during the period of lactation bacilli may pass into the milk in a similar manner (Straus and Chamberland).

Kidney.—The glomerular and inter-tubular capillaries are engorged with bacilli: the epithelium is intact. Rupture of small blood vessels often takes place and bacilli then pass into the tubules and so into the urine (Chamberland and Straus).

Mesentery and intestine.—The vessels of the mesentery and of the intestinal villi are engorged with bacilli.

Anthrax bacilli are present in the excreta of infected animals. Cinça and Fenea have shown that the numbers of bacilli increase with the duration of the disease. In the intestine as in the soil the conditions are favourable for spore formation.

Muscles. Nervous system.—Very few bacilli are found in the muscular and nervous tissues, etc.

Placenta.—In pregnant females the bacilli do not pass through the placenta so long as the vessels are intact; but the vessels frequently rupture, and so the bacilli are enabled to pass the placental filter and infect the foetus (Straus and Chamberland, Perronçito, and Toussaint).

SECTION II.—MORPHOLOGY.

1. Microscopical appearances and staining reactions.

Under the microscope the bacillus presents three different appearances. In the tissues of man and animals infected with anthrax it occurs exclusively in the *bacillary* form; in cultures, *filamentous forms* and *spores* are found in addition.

(i) The bacillary form.

In the blood of animals infected with anthrax the bacilli occur as small rods $5-10\mu$ by $1-1.5\mu$, straight, flexible, non-motile and staining uniformly.

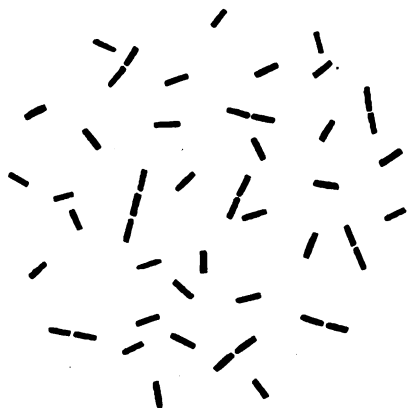

FIG. 249.—*Bacillus anthracis*. Blood film from an ox dead of anthrax. Gram's stain. (Oc. 2, obj. $\frac{1}{3}$ th, Zeiss.)

The organisms are arranged singly or in short chains of two or three bacilli : sometimes the individuals in the chains are separated from one another by such a small space that they appear rather as one long filamentous bacillus.

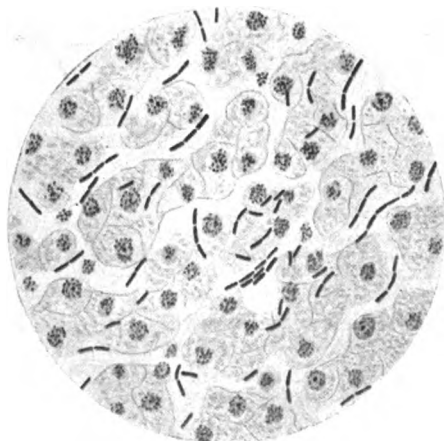

FIG. 250.—*Bacillus anthracis*. Section of liver. Gram's method and eosin. (Oc. 2, obj. $\frac{1}{3}$ th, Zeiss.)

If unstained preparations be examined the bacilli appear transparent like glass.

In the gelatinous œdema the bacilli are a little longer than in blood ; it is also to be noted that the length of the bacilli varies in different animals and also according to the virulence of cultures. A slightly attenuated virus gives long forms, more virulent organisms are shorter and thick-set.

In the living tissues the bacilli never form spores, reproduction taking place solely by fission.

Staining methods.—The bacillus is readily stained by all the basic aniline dyes. It is gram-positive. After staining it will be noticed that the ends are never rounded but always square cut. Under very high magnification the ends show an outline which is [ragged or] sinuous rather than straight, as though the bacillus had been roughly broken. This appearance is characteristic of the organism. On account of its large size an oil-immersion lens is not generally necessary for the examination of microscopical preparations, a high-power dry objective being of sufficient magnifying power.

Staining of films and sections.—Gram's method will be used for choice in searching for and identifying the organism in blood films, smears and sections. The mesentery and films and smears of the internal organs should be stained by the double method (eosin and violet), sections by the double or triple method (Orth's picro-carmin and violet). The technique is described fully at p. 219.

Capsules.—The bacillus of anthrax in the blood and in smears from the spleen frequently shows a very distinct capsule (Serafini). This capsule is



FIG. 251.—*Bacillus anthracis*. Blood film from an ox dead of anthrax. Jenner's stain. (Oc. 2, obj. 4th, Zeiss.)

visible in preparations stained by carbol-thionin or carbol-blue and may also be demonstrated by the ordinary methods for staining capsules (p. 148).

[In examining blood from an animal suspected to have died from anthrax the film is best stained either with Jenner's stain or with an alkaline solution of methylene blue. With Jenner's stain the organism shows a well marked capsule. The bacillus itself stains blue while the capsule assumes a delicate pink tint. This method has been found of the utmost value in practice and enables a distinction to be drawn at sight between the anthrax bacillus and the bacillus of malignant oedema, an organism by no means infrequently found in blood-films made from dead animals.]

(ii) Filamentous form.

In cultures the anthrax bacillus usually occurs in long filaments which are best studied in a broth culture in which they are longer than on solid media.

The bacterial filaments are 1–2 μ broad, very long, wavy, cylindrical, flexible and fitting one within the other like the strands in a skein of silk. They are squarely cut at the end, are never branched and appear to be absolutely non-motile.

R. Dupond has however noticed a very slow and flexuous movement in a broth medium containing no salt when examined on a warm stage at 38° C. After making several sub-cultures of the first vaccine of the Institut Pasteur on glycerin-sugar-agar he was able by staining to demonstrate flagella arranged regularly around the bacilli.

Staining methods.—Like the bacillary form, the filaments stain with the basic aniline dyes (carbol-thionin is best) and are gram-positive.

When stained the filaments are seen to be made up of an hyaline sheath enclosing a number of homogeneous protoplasmic segments separated one from another by transverse partitions, each segment representing a cell which rapidly forms a spore.



FIG. 252.—*Bacillus anthracis*. Broth culture. Carbol-thionin. (Oc. II, obj. 8, Reich.)

(iii) Spores.

To study the formation and development of spores it is necessary to examine a hanging-drop preparation. The best method is to use a Koch's cell; place a drop of aqueous humour on the cover-glass and sow it with a trace of anthrax blood.

If the cell be kept at a temperature of 35°–37° C. a small refractile point will appear within the protoplasm of the bacilli in the course of a few hours. This point increases in size and by reason of its refractibility becomes a distinctly visible ovoid body. The spore is the resistant form of the bacillus.

Spore formation only takes place under certain conditions: the presence of free oxygen is essential and the cultures must be grown at a temperature between 18° and 41.5° C. Above 42° C. spores are not formed.

The protoplasm of the original bacillus soon breaks up leaving the spore surrounded merely by the delicate membrane which enclosed the organism in its filamentous form and this in turn disappears leaving the spore free. No one bacillus ever gives rise to more than one spore and this is

always smaller than the mother cell; some of the bacilli are sterile so that a spore does not form in every cell of the chain.

If the medium is sufficiently nutritive, the spore will soon begin to change into a bacillus. It first increases in size and loses its refractibility, then the enveloping membrane is absorbed leaving the protoplasm free, finally it elongates and assumes the bacillary form (De Bary).

Staining methods.—The spores of anthrax may be stained by the methods described in Chap. IX. It is difficult to stain the spores by the double method, but if attempted absolute alcohol should be used for decolourization and not acids (p. 147).

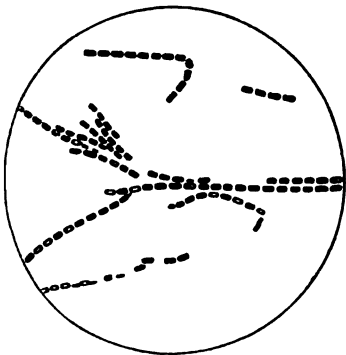

FIG. 253.—*Bacillus anthracis*. Möller's method. To demonstrate spores. $\times 925$. From Curtis' *Essentials of Practical Bacteriology*.

(iv) Involution forms.

In non-sporing cultures obtained by methods which will be described later, involution forms are frequently seen: these are curved and the ends more or less swollen (fig. 254). In attenuated cultures Chauveau described abnormal forms, sometimes short and sometimes thin and filiform, with a spore at the end giving the bacillus the appearance of a nail.

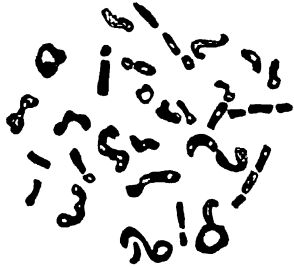

FIG. 254.—*Bacillus anthracis*. Involution forms from an old culture on agar. $\times 1200$.

In collodion sac cultures in dogs the anthrax bacillus loses its virulence and occurs as single coccal-like bacilli (Phisalix) which stain by Gram's method and liquefy gelatin. These forms seem to have a certain degree of stability and constitute a true variety (*B. anthracis brevigemmans* of Phisalix).

2. Cultural characteristics.

Conditions of growth.—The bacillus is essentially an aerobic organism.

Rosenthal has shown that the anthrax bacillus can be converted into a facultative anaërobie by growing it in media containing smaller and smaller quantities of oxygen. Having changed into an anaërobie it no longer forms spores and is much less resistant to adverse conditions.

[Parry Laws several years ago showed that when the anthrax bacillus was sown in broth and incubated in a complete vacuum the organism when examined microscopically showed no spores, exhibited a peculiar morphology and died in ten to twenty days but if sub-cultivated in broth and grown under aerobic conditions the organism reassumed its normal characteristics.]

The optimum temperature is 35° C. but growth occurs at any temperature between 14° C. and 43° C. and spores form when the cultures are incubated at temperatures between 18° C. and 42° C. The bacillus requires a neutral or slightly alkaline medium.

Characters of growth. Broth.—After incubation for a few hours at 35° C. delicate flakes make their appearance in the medium which subsequently increase in size and adhering together fall to the bottom of the tube, leaving the medium clear.

Gelatin.—The anthrax bacillus liquefies gelatin.

(a) *Stab cultures.*—After incubating for 48 hours at 20° C. a whitish track appears along the line of sowing and from this numerous delicate, downy filaments soon grow out at right angles giving an appearance similar to the "tree of Saturn" (fig. 255). The growth continues to increase in amount and the lateral offshoots become thicker: later the gelatin begins to liquefy at the upper part of the tube and the liquefaction gradually extends through the medium, until in 10 or 12 days the whole is liquefied. At this stage the growth has the appearance of large white flakes floating in a clear liquid; finally the flakes fall to the bottom of the tube.

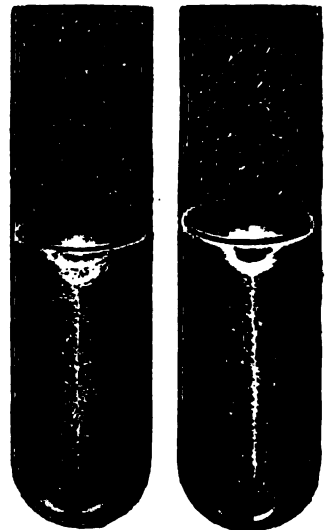

FIGS. 255, 256.—*Bacillus anthracis*. Stab cultures on gelatin at 20° C. (3 days and 5 days).

Sometimes the arborization is wanting in which case the culture is reduced to the central streak. Branching cultures are especially observed when the medium is sown with anthrax blood.

(b) *Plate cultures.*—Towards the second day small greyish-white points appear scattered through the gelatin on the plates.

These points increase rapidly in size and form brownish, granular rounded spots with wavy margins. A low power lens shows these colonies to be made up of interlaced filaments which give them the appearance of a tangled ball of silk. Towards the fourth or fifth day the colonies look as though they were made up of twisted threads and resemble curly hair [Judge's wig appearance]. The gelatin then becomes liquefied around the colonies which break up and form flakes floating in the liquefied gelatin.

Agar.—After incubation for 24 hours at 35°–37° C. a whitish streak appears on the sloped surface of the agar which rapidly thickens, becomes rather dry and friable and has lightly notched borders. The growth on agar is not very characteristic.

Potato.—On this medium at a temperature of 35°–37° C. there appears after the second day a whitish deposit which rapidly thickens and assumes a dull white colour, becoming brown on keeping (fig. 258).



FIG. 258.—*Bacillus anthracis*. Culture on potato (3 days at 37° C.).

towards the third or fourth day. The coagulum is redissolved about the end of the week. If a flask be used no coagulation takes place but the milk acquires a yellowish colour.

Litmus-lactose-gelatin.—The medium is slightly reddened by the growth of the anthrax bacillus.

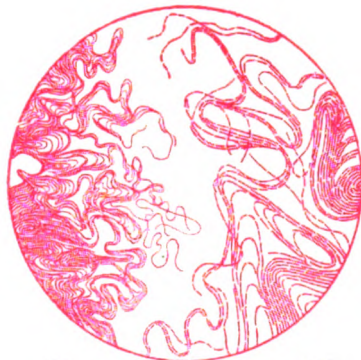

FIG. 257.—*Bacillus anthracis*. Impression preparation from glycerin-agar. From Curtis' *Essentials of Practical Bacteriology*.

Serum. *Liquid serum.*—After incubation for 2 days at 35° or 37° C. flakes are seen floating in the medium which subsequently fall to the bottom of the tube.

Coagulated serum.—The growth appears as a dull white streak becoming greyish after a few days; the serum is partly liquefied.

Milk.—When sown in a tube of milk and incubated at 35° or 37° C. coagulation takes place

SECTION III.—BIOLOGICAL PROPERTIES.

1. Viability. Resistance.

The non-sporing bacillus is quickly killed by exposure to a temperature above 50° C. At 51° C. anthrax blood is sterilized in half an hour. Exposure even to very low temperatures (–100° C. for 1 hour) does not kill the bacillus. The absence of oxygen or immersion in compressed oxygen kills the non-sporing bacillus.

Spores, the resistant form of the organism, possess the full virulence of the bacillus. In soil the spores can retain their vitality as well as their virulence for more than 15 years (Sirena). Spores in the moist condition resist a tem-

perature of 70° C. for a very long time and a temperature of 85° C. for 5 minutes. In the dried state and especially in presence of albuminous matter such as blood their resistance is even greater; they will then tolerate a temperature above 100° C. and resist the action of absolute alcohol, of compressed oxygen, complete absence of oxygen, exposure to sunlight, etc.

Arloing however has shown that in cultures spores resist the action of sunlight less well than the non-spore-bearing bacillus. This may be explained by assuming that sunlight acts more powerfully on young bacilli developing from spores than on the full-grown bacillus.

The spore only develops into a bacillus in presence of free oxygen.

The non-sporing bacillus.—Pasteur noted that in old cultures on gelatin the organism sometimes loses its power of forming spores.

If broth be sown with anthrax blood and incubated at 42·5° C. the bacillus grows but no spores are formed: in the rods small bright granules are seen—the *false spores* of Chauveau—but these have none of the properties characteristic of spores.

Non-sporing bacilli obtained in this way when resown in a medium kept at the optimum temperature soon revert to the sporing form. To obtain a definitely non-sporing variety one of the following methods must be adopted:

A. The carbolic acid method of Roux. Recommended.—1. Distribute about 10 c.c. of a slightly alkaline peptonized veal broth into each of a number (30 to 50) of tubes.

2. Divide these tubes into series of ten each. Number the tubes of each series 1, 2, 3, . . . 10, and to each tube add a 1 per cent. aqueous solution of carbolic acid (without alcohol) in the following quantities:

| | | | |
|---------------|----------------------------------|------------------|---|
| to tube No. 1 | equivalent to $\frac{2}{10.000}$ | of carbolic acid | = 0·2 c.c. of the carbolic acid solution. |
| .. No. 2 | .. $\frac{4}{10.000}$ | .. | = 0·4 c.c. " |
| .. No. 3 | .. $\frac{6}{10.000}$ | .. | = 0·6 c.c. " |
| .. No. 10 | .. $\frac{20}{10.000}$ | .. | = 2·0 c.c. " |

3. Plug the tubes with wool, seal off the ends in the blow-pipe above the plug to prevent evaporation of the carbolic acid, and then sterilize in the autoclave.

4. When cool open the tubes and sow with a drop of anthrax blood: care should be taken to drop the blood into the broth and not on to the side of the tube.

5. Cover the mouths of the tubes with india rubber caps and incubate at 33°–37° C.

6. After incubating for about 10 days examine the cultures. In some of the tubes, those containing the largest amount of carbolic acid (tubes 7–10, for instance) growth will have been altogether inhibited; the tubes numbered say 1 to 3 will contain both bacilli and spores; the tubes numbered 3, 4, 5, 6 will contain bacilli but no spores.

To determine whether or not spores are present draw up a little of the culture into a very fine Pasteur pipette constricted below the wool plug (p. 75). Seal the ends of the pipette in the flame and put it in a water bath at 65° C. or 70° C. for 15 minutes or so. If the bacillus is non-spore-bearing it is killed at this temperature so that when the heated contents of the pipette are sown in broth the medium remains sterile. If on the other hand the bacteria are spore-bearing growth takes place.

Sometimes none of the tubes contain asporogenic bacteria, and at other times a large number are obtained which however may revert to the sporing form after a few sub-cultures in broth at 33°–37° C.

Surmont and Arnold have shown that the faculty of becoming asporogenic varies much among bacteria recovered from different sources. A bacterium obtained

from the Institut Pasteur easily became asporogenic in the hands of these investigators although they failed when they worked with a bacterium isolated by themselves from a case of human anthrax.

B. The bichromate method of Chamberland and Roux.—Bichromate of potassium is used in the same way as the carbolic acid in the previous experiment but in different proportions. A solution of 1 in 2000 in broth is the best.

C. Other methods.—The following may be placed on record here but none of them have up till the present given satisfactory results. The method of von Behring depends upon the use of rosolic and hydrochloric acids; that of Phisalix is based upon the application of heat (successive cultures at 42.5° C.). More recently Phisalix and also Bormans have advised repeated sub-cultivation on horse or dog serum; Phisalix also recommends collodion sac cultures in the peritoneal cavities of dogs and other animals.

2. Virulence. Attenuation. Pasteur's vaccination.

Virulence.—In man one attack of anthrax confers an absolute immunity. As a rule, anthrax is fatal to domestic animals, but Pasteur found that cows which had recovered from an attack of the disease were able to resist without ill-effect the subsequent inoculation of a very virulent organism. It had been observed also that in the district of La Beauce some of the sheep were immune to anthrax, and by way of explanation the suggestion had been made that these immune animals had already suffered from an abortive attack of the disease. From these facts Pasteur inferred that if he could infect animals with a mild form of anthrax, he would be able to render them immune to the epizootic disease.

Attenuation.—To demonstrate the truth of this inference an attenuated virus had to be prepared. But since the virulence of the bacterium is retained intact and perpetuated by the spore which originates in it the bacillus had to be prevented from forming spores. The method by which this was and is still done is as follows:

1. Sow a flask of broth with anthrax blood and incubate at 42.5° C. The organism grows but does not form spores.

The virulence of the bacillus is at first considerable but soon diminishes and after about 8–10 days is harmless on inoculation to guinea-pigs and rabbits. This attenuation is due to the combined action of air and heat on the micro-organism.

If the attenuated culture be inoculated into a sheep the animal suffers from a very mild attack of anthrax and, after it has recovered, it will be found to be capable of resisting the inoculation of a fully virulent organism.

That is to say, the *inoculation of an attenuated virus confers an immunity* upon the animal inoculated.

2. If the attenuated bacillus be sown in a flask and incubated at 33°–37° C. it will again form spores but the virulence will be that of the bacillus in which they develop; in this way the virulence is fixed and may be indefinitely perpetuated.

Restitution of the virulence.—The virulence of an attenuated bacillus which has become saprophytic can be restored by passage through suitable animals.

For instance, take a bacillus which fails to kill an adult mouse, and inoculate it into a mouse which has just been born. The latter dies in 2 or 3 days. Inoculate a little of the blood of this first animal into a second mouse 3 days old and after it is dead inoculate some of its blood into a mouse 6 days old. Inoculate the blood of the latter into an adult mouse then some of the blood of the adult mouse into a young guinea-pig and so on through an adult guinea-pig, a rabbit, a sheep and a bovine animal: finally a fully-virulent organism will be recovered.

Pasteur's method of vaccination.—The more severe the vaccinating infection the more highly immunized will the animal be.

On the other hand there is the danger that if a powerful vaccine be inoculated in the first instance the animal may die and the experiment have to be recommenced.

In practice a compromise is effected by using two vaccines. The first inoculation is made with a very weak vaccine which will kill mice but has no ill-effect on rabbits and sheep (*premier vaccin*). The second inoculation is given 12 days later: it is somewhat more virulent than the first vaccine and will kill mice and guinea-pigs and, twice out of six or eight times, rabbits (*second vaccin*). Immunity is established 12 days after the second inoculation.

The vaccine prepared by the Institut Pasteur is supplied to veterinary surgeons at a trifling cost in tubes containing 100 doses. The first and second vaccines are inoculated successively, the dose for a cow being 0.25 c.c. and for a sheep 0.125 c.c.

As a rule, the inoculations are given as follows: The first vaccine is inoculated into the internal surface of the right thigh and the second into the internal surface of the left thigh, an interval of 12 days elapsing between the two operations. The vaccine must be used as soon as it is procured and the inoculations must be done with a sterile syringe. It is important not to use a contaminated vaccine, because by contamination it has lost its properties.

Immunization of small animals.—The immunization of small animals is difficult but necessary for laboratory investigations. Rabbits and guinea-pigs are so highly susceptible that death often occurs during the process. For such animals three vaccines of different virulence ought to be available, the first very attenuated, the second the *premier vaccin* and the third the *second vaccin* described above. The inoculations should be carried out very cautiously.

Marchoux succeeded in immunizing laboratory animals by using only the "sheep vaccines." These vaccines were grown at 37° C. in a peptonized veal broth and used when 24 hours old. The first vaccine given under the skin of a rabbit consisted of 0.5 c.c. (maximum non-fatal dose) of the more attenuated of the two sheep vaccines. It caused a rise of temperature, diarrhoea and loss of weight. The second vaccine given 12 days later consisted of a double dose of the same vaccine. The third inoculation given after another interval of 12 days consisted of 0.25 c.c. of the more virulent of the sheep vaccines (*second vaccin*) and 12 days later again a fourth inoculation of 0.5 c.c. of the latter vaccine was inoculated. A week after the last inoculation the animal was tested by the inoculation of a few drops of anthrax blood under the skin. If the reaction was not too violent the immunizing process was continued and completed by the frequent inoculation of anthrax blood or of virulent cultures 24 hours old. Marchoux succeeded in immunizing some of his rabbits to such a degree that they were able to resist the daily inoculation of 1 c.c. of fully virulent bacilli while other rabbits could resist the inoculation every fifth day of gradually increasing doses up to 20 c.c.

Immunization by avirulent cultures.—De Christmas showed that white rats can be immunized with totally avirulent cultures. He injected into the peritoneal cavity of white rats 1 c.c. of a watery emulsion of a young avirulent culture on three different occasions at intervals of a month. The material for sowing the cultures was taken from a non-sporing strain which had been grown for a number of years at the Institut Pasteur and which was totally devoid of virulence for white rats. All the animals vaccinated in this manner were inoculated a month after the last immunizing inoculation with a large dose of a virulent anthrax bacillus which was certainly fatal to control animals, and were found to be immune.

3. The toxin of anthrax.

The nature of the toxin secreted by the anthrax bacillus is not yet definitely determined.

The toxalbumin which Hankin prepared from cultures of the bacillus grown in Liebig's broth containing fibrin and that which Brieger and Fränkel extracted from carcasses dead of anthrax were only obtained by complicated processes hardly compatible with the isolation of a very delicate chemical substance. It is to be feared that impurities were responsible for many of the results which followed the inoculation of these toxins.

Sidney Martin obtained an albumose in solutions of alkali albumin which in doses of 3 cg. killed mice weighing 22 grams with symptoms very similar to those seen in anthrax septicæmia.

Marmier's toxin.—Marmier obtained an active toxin by growing the organism at a low temperature in a solution of pure peptone containing glycerin.

Marmier's medium.—To prepare Marmier's medium the first step is to purify ordinary commercial peptone, thus: dissolve a certain amount of peptone in water, add sufficient sulphate of ammonium to saturate the solution at 100° C. then boil for a few minutes and filter. To the filtrate add sufficient barium hydroxide to precipitate all the sulphuric acid present. Heat the mixture for several hours to a temperature near the boiling point to drive off the ammonia: filter to remove the barium sulphate and keep the filtrate boiling while passing a current of air through it to remove all traces of ammonia; then pass through it a current of carbon-dioxide to precipitate the excess of barium hydroxide, and finally filter. With this purified peptone solution the following medium is prepared:

| | | | | | | | | | | |
|----------------------|---|---|---|---|---|---|---|---|------|--------|
| Water, | - | - | - | - | - | - | - | - | 1000 | c.c. |
| Peptone, | - | - | - | - | - | - | - | - | 40 | grams. |
| Common salt, | - | - | - | - | - | - | - | - | 15 | „ |
| Sodium phosphate, | - | - | - | - | - | - | - | - | 0.5 | gram. |
| Potassium phosphate, | - | - | - | - | - | - | - | - | 0.2 | „ |
| Pure glycerin, | - | - | - | - | - | - | - | - | 40 | grams. |

Filter, distribute in flasks of 250 c.c. capacity and sterilize at 115° C.

To prepare the toxin sow the medium with a virulent anthrax bacillus and incubate for 48 hours at 37° C. and afterwards at 20° C. for a fortnight.

Now filter the culture through porcelain and saturate the filtrate with ammonium sulphate at the temperature of the laboratory. After standing for about 15 hours filter through paper and wash the filter with a saturated solution of ammonium sulphate. Wash the precipitate which remains on the filter paper with as small a quantity of glycerin as possible: leave for 2 days, decant the glycerin, replace it by fresh glycerin and decant again. Mix the glycerin solutions together and add the mixture to four times its weight of strong alcohol: pour the precipitate on a filter and wash first with absolute alcohol, then with ether and finally dry *in vacuo*. The product is an amorphous, easily powdered substance dark brown in colour and contains small quantities of ammonium sulphate. It is soluble in distilled water and in 1 per cent. carbolic acid. It has none of the properties of albuminoid substances, peptones, parapeptones nor alkaloids.

This substance is rather toxic for rabbits and the inoculation of small doses may cause the death of the animal, but the dose varies for each individual within somewhat wide limits. Thus some rabbits succumb to the inoculation of 25 mg. (in aqueous solution) while for others the fatal dose is as much as 120 or even 200 mg.

A few hours after inoculation there is a well-marked rise of temperature: for a few days the temperature oscillates widely, and then if the animal is going to die it falls steadily (perhaps as low as 8° C. below normal), if on the other hand the animal is going to recover the temperature oscillates less and less. The animal is ill, cachectic, and may lose one-third of its weight; as a rule diarrhœa is a symptom.

Before death symptoms of paraplegia appear, respiration is laboured and the animal lies on its side and may have convulsive attacks.

Death may take place at any time between the 2nd and 15th or 20th day after inoculation, the duration of life depending upon the amount of toxin inoculated.

Guinea-pigs and mice are susceptible to the toxin.

Contrary to Hankin's experience animals immune to anthrax are almost unaffected by the toxin: this is also true with rabbits immunized with attenuated cultures.

The toxin is weakened but not completely destroyed by heating it to 110° C. The addition of alkaline hypochlorites, chloride of gold, or Gram's solution destroys its toxic properties, as does also prolonged exposure to sunlight in presence of air.

Cultures of anthrax in other liquid media (ox serum or broth made with beef, veal or horse) contain but little toxin. Marmier was able to extract an active toxin from recent cultures on agar: the growth from 48-hour old cultures on agar was scraped and macerated in alcohol containing a few drops of ether at 20° C.; after autolyzing for 24 hours the emulsion was filtered and the filtrate precipitated with absolute alcohol: the precipitate on the filter was washed with absolute alcohol then with ether and finally dried *in vacuo* over sulphuric acid. The powdery product was as toxic as the toxin prepared from cultures in glycerin-peptone-water. This indicates that primarily the toxins are intra-cellular.

Vaccination with Toxin.

I. Toussaint conferred immunity on sheep by inoculating them with defibrinated anthrax blood heated to 55° C. for 10 minutes.

Better results are obtained if the anthrax blood be heated to 60° C. on three or four different occasions before injecting the sheep. A slight degree of immunity is obtained in this way which disappears after a lapse of time varying from a month to 3 years (Roux and Chamberland).

II. Hankin stated that with a toxin which he had prepared by growing the bacillus in broth made with Liebig's extract and containing fibrin, animals could be easily immunized against anthrax. After certain objections had been raised by Peterman, Hankin reinvestigated the subject and obtained less satisfactory results. If the inoculation of toxin in amounts equal to $\frac{1}{1,000,000}$ of body weight has any immunizing action at all on mice it must be of a transitory nature and in any case only a small proportion of animals treated in this way resist the test inoculation.

III. Marmier succeeded in immunizing laboratory animals with a toxin prepared by growing the bacillus in glycerin-peptone-water. Rabbits after being repeatedly inoculated with small doses acquired a certain degree of immunity which however did not last longer than 5 or 6 weeks after the last inoculation. It is nevertheless possible to immunize rabbits against doses of toxin which if given to untreated animals would cause their death.

The method is as follows: The rabbit is first of all inoculated with a very small dose of this toxin, for example 3 mg., and when it has recovered, that is to say in about 6 days, a larger dose (6 mg.) is administered and when the reaction has subsided a third dose of 15 mg. is given. About 12 days after the third inoculation the animal can, in the majority of cases, survive the inoculation of a virulent culture of anthrax. By gradually increasing the amount inoculated to 20 and 30 mg. immunity can almost certainly be ensured. Care must be taken to see that the animal has completely recovered from the effects of the immunizing inoculations before giving the test inoculation.

4. Serum therapy.

I. Behring has shown that the serum of white rats exhibits bactericidal properties against the anthrax bacillus. When a small quantity of a culture

of the anthrax bacillus is mixed with some rat serum and inoculated into mice, the mice suffer no harm (p. 518).

Roux and Metchnikoff have proved that the bactericidal action of the rat serum is only exercised when the serum is mixed with the bacilli; if the culture and serum be separately inoculated, the mice die of anthrax. These observers also showed that the high degree of immunity to anthrax usually possessed by the white rat is not due to the bactericidal action of its serum for they found that a large number of white rats whose serum was known to be bactericidal were susceptible to the disease.

II. Marchoux has shown that the serum of rabbits and sheep immunized against anthrax by means of attenuated cultures, while possessing both prophylactic and therapeutic properties, has no bactericidal or antitoxic action.

The rabbits should be immunized by the method described at p. 528. Sheep after being vaccinated by Pasteur's method are inoculated with larger and larger doses of virulent cultures at intervals of a week until an amount equal to 200-300 c.c. is given in one inoculation. The sheep must be able to withstand these enormous doses before their serums become prophylactic or curative. The animal is bled 15 or 20 days after the last protective inoculation as experience has shown that the serum is most potent at this period. The serum retains its properties for a long time.

(a) Marchoux obtained a sheep serum which had a titre of $\frac{1}{2,000}$ (1 c.c. inoculated 24 hours before 0.25 c.c. of a virulent culture protected a rabbit weighing 2 kg.). The inoculations were made beneath the skin of the flank, the serum on one side the culture on the other.

Inoculation of culture beneath the skin of the ear has more severe results, and to protect the animal twice the quantity of serum used in the preceding case must be given. Inoculation of culture into the peritoneum requires a still larger protective dose of serum, at least 15 c.c. of a $\frac{1}{2,000}$ serum being required to protect a rabbit weighing 2 kg. When the culture is administered intra-venously 20 c.c. of a $\frac{1}{2,000}$ serum only prolongs the life of the rabbit for 3 days beyond that of the control.

The serum is equally effective whether inoculated intra-peritoneally or sub-cutaneously. Intra-venous injection however appears to be less effective since 10 c.c. of a $\frac{1}{2,000}$ serum does not protect a rabbit weighing 2 kg. against the sub-cutaneous inoculation of 0.25 c.c. of a virulent culture.

Note.—A $\frac{1}{2,000}$ serum has no prophylactic properties for guinea-pigs. Even by using very large doses of serum Marchoux was able only to prolong life and that but for a variable length of time.

(b) The serum of a vaccinated rabbit inoculated at the same time as a virulent culture ensured the recovery of the animal (rabbit) in 7 out of 24 experiments: in the remaining 17 cases the animal always lived longer than the controls. The amount of serum inoculated varied from 7-17 c.c. The rabbits which survived showed no symptom of illness while all those in which an œdema developed, died.

(c) A rabbit which was given 6 c.c. of the serum of a vaccinated rabbit 4 hours after the inoculation of bacilli survived. And another in which the serum was administered 7 hours after the inoculation of bacilli died 108 hours after the control.

With a $\frac{1}{3,000}$ sheep serum Marchoux was able to cure a rabbit inoculated 7 hours previously (dose, 7 c.c. of serum). With a $\frac{1}{2,000}$ serum the inoculation of 10 c.c. given 24 hours after the culture was followed by recovery.

If at the moment of inoculation of the serum there is a well-marked œdema recovery does not take place even though relatively enormous doses of serum be used (e.g. 15-20 c.c. of a $\frac{1}{2,000}$ serum).

Note.—When the serum is inoculated before or immediately after a virulent culture, the rabbit shows no signs of illness but it has acquired no immunity against the bacillus: for, if inoculated later, it succumbs to anthrax after the same lapse of time as control animals. On the other hand, when there has been some delay so that the serum is not given for 7–24 hours after the infection the animal has become sufficiently ill to enable it to acquire, during recovery and with the aid of the serum, a marked resistance to anthrax.

III. Sclavo undertook a series of experiments which enabled him to produce serums endowed like that of Marchoux with prophylactic and therapeutic properties but devoid of all bactericidal or antitoxic properties.

(a) Sheep after being first treated with the two vaccines of Pasteur were then repeatedly inoculated with virulent cultures in gradually increasing quantities. A serum was thus obtained which in doses of 2 c.c. protected rabbits against doses of anthrax fatal to animals not so treated.

(b) Asses are still more useful for the preparation of antianthrax serum. Ottolenghi prepared an ass serum by Sclavo's method which protected guinea-pigs against a very virulent virus provided that it was administered intra-peritoneally 24 hours before the test inoculation.

(c) It is easy to secure a sero-vaccination in guinea-pigs by inoculating 6 c.c. of immunized ass serum sub-cutaneously and 1 c.c. of Pasteur's first vaccine intra-peritoneally.

IV. Sobernheim, repeating and extending Sclavo's work immunized sheep by inoculating them with 10 c.c. of serum intra-venously and with a culture of anthrax sub-cutaneously: if sheep immunized in this way be repeatedly inoculated with virulent cultures a very active serum is obtained.

Sobernheim succeeded in conferring a substantial immunity on horses and sheep in 10–12 days. The animals were inoculated with 5 c.c. of serum and 0.25–0.5 c.c. of a culture of anthrax sub-cutaneously in different parts of the body. According to Sobernheim the successful use of the serum depends above all in using it in combination with the virus.

V. Sanfelice prepared a dog serum having very marked prophylactic and therapeutic properties. The dogs were first of all inoculated sub-cutaneously with cultures attenuated by growing them for 5–7 days at a temperature of 37° C. and subsequently with more and more virulent cultures. The process of immunization lasted about a month. The serum was then found to be very powerfully prophylactic for rabbits but not for guinea-pigs. It possessed neither bactericidal or antitoxic properties but nevertheless proved of value as a therapeutic agent: in doses of 7 c.c. per 1 kg. of body weight it arrested the infection in rabbits if given within 40 hours of the inoculation of bacilli. If the delay were greater than this death ensued whatever the dose employed.

In a man infected with anthrax Sanfelice observed that the symptoms abated on the third day after the inoculation of 56 c.c. of serum.

[Human serum therapy.—Immune ass serum prepared by Sclavo's method has been used in the treatment of anthrax in man since 1897 with distinctly encouraging results.

[The inoculations are administered sub-cutaneously. The first inoculation consists of a dose of antianthrax serum followed the next day by a dose of a broth culture of the second vaccine; ten days later an inoculation consisting of a mixture of antianthrax serum and virulent anthrax bacilli is given and then at more or less regular intervals of 10 days gradually increasing doses of virulent anthrax bacilli without serum until, when tested on rabbits, it protects these animals from a dose of living virulent bacilli sufficient to kill control rabbits. The ass is bled to the extent of about 150 c.c. after a suitable interval from the last inoculation and the immunity is maintained by the inoculation of young gelatin-broth cultures sub-cutaneously at intervals.

[For the treatment of anthrax in man the initial dose of the serum should be large—40 c.c.—and may be repeated if necessary. The serum is generally inoculated sub-cutaneously but in severe cases intra-venously. As with all other therapeutic serums the sooner it is administered after the infection has taken place the better will be the result of the treatment.

[The immediate results following inoculation of the serum are sometimes rather startling; the temperature rises often to over 105° F. and the patient becomes very ill, at the same time the local lesion appears to get much worse and the œdema increases. Then follows a period of recovery during which the temperature falls to normal, the size of the inflamed area diminishes and the bacilli disappear from the lesion.

[The rapid disappearance of bacilli from the lesions is one of the most striking results of serum treatment. In one of the first cases treated in England Andrewes found that no bacilli could be cultivated from the fluid of the vesicles 19 hours after the administration of 40 c.c. of serum though previously abundant colonies developed on the medium sown with the fluid.

[" The claims which have been made as to the effect of serum treatment can be summarized by saying that: (1) even in very large doses it is innocuous; (2) it can be well borne even when introduced into the veins; (3) no case taken in an early stage or of moderate severity is fatal if treated with serum; (4) with the serum some cases are saved when the condition is most critical and prognosis almost hopeless; (5) when injected into the veins the serum quickly arrests the extension of the œdematous process so as to reduce notably the danger from suffocation which exists in many of the cases where the pustule is situated on the face or neck; (6) if used soon enough it reduces to a minimum the destruction of the tissues at the site of the pustule; (7) in some situations of the pustule, as the eyelid, serum treatment must be used in preference to any other as it alone can hold out hope of success without permanent injury; and (8) in internal anthrax it is the only treatment which holds out any hope of benefit" (Legge).

[In 1903 Sclavo tabulated all cases known to have been treated with his serum up till that time in Italy. In all 164 cases were treated with 10 deaths—a rate of 6.09 per cent. as against 24.1 per cent. for the whole of Italy.]

5. Agglutination.

Cultures of the anthrax bacillus do not lend themselves to the demonstration of the phenomena of agglutination because the bacilli are linked together in chains. To study the phenomenon it is necessary to work with attenuated cultures (and especially Pasteur's No. 1 vaccin) with which fairly homogeneous emulsions can be obtained. These emulsions are agglutinated by the serum of various untreated animals (rat, rabbit, guinea-pig, ox, horse, etc.) in dilutions of 1 in 10 to 1 in 50. Normal human serum agglutinates them powerfully—even in dilutions of 1 in 500 in some cases. "Great care should be exercised in the serum diagnosis of anthrax" (Lambotte and Marechal). Sobernheim arrived at a similar conclusion namely that there is no relation between the degree of agglutination reaction and the degree of immunization: sometimes a normal serum will agglutinate as powerfully as a serum obtained from immunized animals.

SECTION IV.—DETECTION, ISOLATION AND IDENTIFICATION OF THE ANTHRAX BACILLUS.

The anthrax bacillus should be looked for—

I. In the serous fluid of the malignant pustule in man and in the gelatinous œdema in the lower animals.

2. In the blood and urine, and in smears and sections of organs, in both man and the lower animals.

The clinical diagnosis of malignant pustule in man should always be confirmed by bacteriological investigation; and in any suspected or ascertained case of the disease the blood and urine should be immediately examined microscopically since in both man and the lower animals the entrance of the bacillus into the blood stream denotes generalization of the infection and a fatal termination, death occurring soon after its appearance.

The blood in the living human subject should be obtained by pricking the finger or the lobe of the ear. In the case of animals the blood is best collected from the ear.

Serum from the malignant pustule may be obtained by scratching the surface of the pustule with a lancet after sterilizing the skin with antiseptics.

Other material can be collected in the ordinary way.

To make a complete bacteriological examination it is necessary to confirm the microscopical examination by sowing cultures and inoculating animals.

(a) **Cultures.**—Sow the material (blood, scraping from organs, exudates etc.) on ordinary media and incubate aëroically.

(b) **Inoculations.**—Inoculate a guinea-pig (for preference) or a mouse subcutaneously with a few drops of blood, or with a scraping from one of the internal organs rubbed up in sterile water, or preferably with a 24-hour growth obtained by sowing the medium with blood or other material.

(c) **Microscopical examination.**—For microscopical examination prepare:

1. *Blood films.*

2. *Smears of the internal organs* and especially of the spleen.

3. *Smears from the gelatinous œdema* or exudate from the malignant pustule.

4. *Mesentery.*—This is best examined in the mouse. Remove a small piece of the mesentery, spread it out on a slide with needles leaving the edges to dry a little so as to assure its adhering to the glass, then pull on it in such a manner as to stretch the membrane, treat with alcohol-ether then stain.

5. *Sections of tissues.*—Cut off small pieces of the liver, spleen, lungs, and kidneys, fix in absolute alcohol and embed in paraffin. Stain as indicated above (p. 522).

The examination of carcasses dead of the spontaneous disease.

When examining material from a dead body it should be remembered that anthrax carcasses very soon after death become invaded by the bacillus of malignant œdema (Chap. XXXVIII.), a micro-organism which on superficial examination is liable to be confounded with the anthrax bacillus (Jaillard and Leplat).

[In England the carcase of an animal suspected to have died from anthrax may not be opened. For bacteriological examination the Board of Agriculture require that an ear shall be cut off.

[The ear should be pinned out on a board and the outer surface washed with 2 per cent. lysol. An incision should then be made with a sterile scalpel from the base to the tip and the skin reflected from the subjacent cartilage. With another sterile knife one of the small veins thus exposed should be cut across an inch or so from the base—to avoid organisms which may have contaminated the cut surface—and the blood squeezed out. Films are then prepared and stained (p. 522) and cultures sown.

[It is of importance to recognize that the mere microscopical examination of blood films cannot be relied upon for the recognition of anthrax in animals suspected to have died of the disease. It is true that in the great majority of cattle which have died of anthrax, bacilli can be seen in large numbers in

blood films prepared as described above but there is a minority of cases in which anthrax exists but in which the bacilli cannot be found on microscopical examination because the organisms are present only in very small numbers in the blood. In horses, and especially in pigs, a negative result on microscopical examination is of no value. Agar cultures must be sown therefore in every suspected case of anthrax in animals. If bacilli resembling anthrax bacilli were found in the blood films, examination of the cultures will confirm the diagnosis;—the bacillus of malignant œdema does not grow on agar under aerobic conditions. In those cases in which no bacilli were found in the blood films and cultures yield an organism resembling the anthrax bacillus the diagnosis must be confirmed by the inoculation of a guinea-pig.]

Cinça and Stoiesco have shown that it is of great advantage to examine the skin in cases where the carcass has begun to decompose. The anthrax bacillus can always be found in the skin even though it may have disappeared from the blood and internal organs.

Cut off small pieces of the skin and leave them to dry, then scrape them with a scalpel and rub up the scrapings with sterile saline solution (10 volumes of saline to 1 volume of tissue). To a series of broth tubes add 1–5 drops of the emulsion, heat the tubes to 65° C. for thirty minutes, then sow on agar, and examine and identify the colonies which develop.

Examination of the intestinal contents may also, according to Cinça and Fenea, afford valuable evidence in diagnosis.

Isolation of the bacillus from soil.

Pasteur utilized the resistance of the spores to heat for the purpose of isolating the organism from the soil of infected fields. The technique is as follows:

Crush a little of the soil in a mortar and make a suspension in sterile water. A granular precipitate is immediately deposited. Decant the supernatant liquid containing only fine light particles with care and let it settle in a sterile test-tube on a foot. The turbid liquid becomes clear and a deposit is formed in the bottom of the tube. Decant the supernatant liquid again. Aspirate the deposit into pipettes and after sealing heat them in a water-bath at 85° C. for 15–20 minutes and use the contents for sowing gelatin plates in Petri dishes. The plates must be carefully watched, and every suspicious colony should be examined microscopically, sown on various media, and inoculated into guinea-pigs and mice.

The pyogenic micro-organisms are destroyed by heating the material to 85° C. and the method of cultivation eliminates all anaerobic species such as the bacillus of malignant œdema which might lead to error in the investigation. In the method originally used by Pasteur the deposit obtained by powdering the soil was inoculated immediately after heating and before colonies were isolated, but this technique is not so exact.

By utilizing a method very similar to that just described, Diastroff succeeded in isolating the organism from the mud at the bottom of a well.

CHAPTER XXXVI.

BACILLUS TETANI.

Introduction.

Section I.—Experimental inoculation, p. 536.

1. Inoculation of soil or pus, p. 537.
2. Inoculation of pure cultures, p. 537.
3. Inoculation of spores, p. 538.

Section II.—Morphology, p. 539.

1. Microscopical appearance and staining reactions, p. 539.
2. Cultural characteristics, p. 540.

Section III.—Biological properties, p. 541.

1. Vitality and virulence, p. 541.
2. Toxin, p. 541.
3. Vaccination, p. 544.
4. Serum therapy, p. 545.
5. Agglutination, p. 548.

Section IV.—Detection, isolation and identification of the tetanus bacillus, p. 548.

Bacillus botulinus.

TETANUS is a disease which affects not only man but all species of domestic animals and is due to the bacillus of tetanus discovered by Nicolaïer.

Tetanus in horses, asses, cows, etc. generally follows wounds of the foot. Tetanus has been known to affect a number of horses in an almost epizootic manner after castration, the organism in these cases being conveyed by the instruments employed in the operation.

Tetanus in man is known to follow accidental wounds or surgical operations: the organism having been introduced at the time of the injury.

Much has also been said about *idiopathic tetanus* which develops in the apparent absence of all solution of continuity of the integuments. These so-called idiopathic cases are due either to an infection through the alimentary canal (Süsser) or more likely to the introduction of the organism some time previously through a wound which has since healed and been forgotten. Vaillard and Rouget have shown that spores introduced into the tissues can remain dormant for a very long time, germinating when the conditions become favourable, and thus setting up a disease which would appear to be *spontaneous*.

The spores of the tetanus bacillus are very widely distributed outside the body. If a guinea-pig be inoculated with garden soil, or with dust or mud from the street it almost always dies either from tetanus or malignant œdema (Nicolaïer). The tetanus bacillus is also found in the contents of the large gut and in the excreta of many animals.

SECTION I.—EXPERIMENTAL INOCULATION.

Mice, rats and guinea-pigs are very susceptible to tetanus, rabbits less so, while dogs are very difficult to infect, and pigeons and fowls are naturally immune to the disease.

Susceptible animals may be infected in many ways.

1. By inoculation of specifically infected pus from a wound in man or the lower animals.
2. By inoculation of soil.
3. By inoculation of a pure culture of the bacillus.
4. By inoculation of the spores from a culture of the organism.
5. By inoculation of tetanus toxin (*vide infra*).

Whatever the mode of infection the tetanus bacillus never invades the tissues of the organism but remains strictly localized at the site of inoculation.

When animals have been inoculated intra-venously or into the peritoneum with a large dose of culture the bacillus may be found in cultures sown with the blood and internal organs. Sanchez Toledo and Veillon occasionally obtained a growth of the bacillus from the blood of an animal dead of tetanus by allowing a certain time to elapse after death before sowing the cultures. But these results are quite exceptional.

A few hours after inoculation the bacilli have diminished in number and it is not long before their presence at the site of injection can only be demonstrated by culture methods. If a minimal lethal dose be inoculated, the material collected *post mortem* from the infected part is not infectious on reinoculation. On the other hand, pus from an infected wound will convey the disease to susceptible animals but it is impossible to effect more than four passages from animal to animal. The second passage animal does not die so quickly as the first and so on; at the fourth passage the virulence of the bacillus is greatly diminished.

1. Inoculation of soil or infected pus.

The inoculation is best effected either beneath the skin or into the muscles of the thigh of a guinea-pig or mouse.

Symptoms and lesions.—A swelling forms at the site of inoculation and the part is puffy and painful; 3 or 4 days after the inoculation symptoms of tetanus appear beginning in the neighbourhood of the infected area, and becoming generalized: the slightest stimulus, such as a noise, a draught of air, a touch etc., will produce spasmodic movements. The clinical condition is exactly the same as in human tetanus. Death occurs 24–48 hours after the onset of the symptoms.

Post mortem: at the site of inoculation there will either be a purulent focus, or a lesion resembling a dry yellow slough, or a thick membranous exudate. The neighbouring tissues are the site of an œdematous infiltration. On microscopical examination numerous other micro-organisms—one or two species predominating—will be found associated with the tetanus bacillus. The purulent, membranous and necrotic lesions are due to organisms other than the tetanus bacillus. The internal organs are healthy and merely show a slight congestion due to the embarrassed respiration which precedes death.

2. Inoculation of pure cultures.

Infection may be set up by inoculating pure cultures sub-cutaneously, intra-muscularly, intra-peritoneally, intra-venously, sub-durally or on to the ocular conjunctiva. Ingestion is the only mode of introduction which fails to produce the disease. Sub-cutaneous or intra-muscular inoculation is the most certain and rapid method of infecting an animal.

Very small doses of broth cultures suffice to set up the disease in susceptible animals. 0·02 c.c. will produce a typical tetanus in mice and guinea-pigs: the symptoms begin 12–20 hours after inoculation and terminate fatally in 36–40 hours.

In the case of rabbits, a dose of 0·5–1·5 c.c. is necessary and even then the

earliest symptoms do not appear until between the second and eighth day and death does not occur until 3–10 days after the onset of the symptoms.

Symptoms and lesions.—Whatever the dose inoculated there is, before symptoms appear, a period of incubation the length of which varies with the virulence of the culture, the dose inoculated and the resistance of the animal. As a general rule, the severity of the disease varies inversely as the incubation period—the shorter the incubation period the more severe and more rapidly fatal the disease. If the incubation period exceed 5 days in guinea-pigs and 8 days in rabbits, the disease assumes the chronic type, lasts some 10–30 days and may end in the recovery of the animal.

As in the previous case the symptoms always begin in the neighbourhood of the inoculation and then, if the dose be sufficient, become generalized. If the dose be very small the symptoms may be limited to the limb or group of muscles affected by the inoculation.

Post mortem.—Beyond the occasional occurrence of a little hyperæmia or a slight œdema, both very circumscribed, there is no lesion at the site of inoculation. Neither can any lesions be found in the internal organs.

Cultures of the tetanus bacillus do not multiply when inoculated into the living tissues, but, on the other hand, the organism quickly disappears.

Cultures filtered through a Chamberland bougie produce the same symptoms as unfiltered cultures. This matter will be dealt with later, here it is sufficient to point out that the results obtained by inoculating cultures are due to the toxin they contain.

3. Inoculation of spores alone (Vaillard, and Vincent and Rouget).

If a broth culture of the tetanus bacillus containing spores be heated at 80° C. for 3 hours, the toxin is destroyed and the broth contains only spores which remain unaffected by the heating process.

Doses of 0·5 or 0·6 c.c. of these heated cultures can be inoculated into guinea-pigs without the animal showing any symptoms of tetanus. Pure spores do not germinate in the living, healthy tissues and cannot therefore manufacture the toxin necessary to produce the symptoms of the disease. Spores inoculated in the pure state are rapidly ingested and digested by the phagocytes.

If however a negatively chemiotactic substance, such for instance as a little drop of lactic acid, be mixed with the spores before inoculation the leucocytes are unable to approach the spores which now, left to themselves, quickly germinate with the result that symptoms of tetanus appear.

The same result may be arrived at by mechanically protecting the spores against the attacks of the leucocytes. For instance, if the spores be mixed with a little sterile sand and wrapped in a small piece of previously sterilized filter paper, the paper envelope constitutes a defence which the leucocytes cannot penetrate; the spores therefore are free to germinate and manufacture toxin with the result that the animal dies of tetanus.

Again, if an injury be produced at the site of inoculation, such as a burn, or a traumatism of the tissues, etc. phagocytosis is interfered with, the leucocytes cannot attack the spores, and the latter develop with the result that the animal will suffer from tetanus.

Numerous cases of tetanus have been recorded following the hypodermic injection of quinine. Vincent has shown that, like lactic acid, the salts of quinine favour the germination of tetanus spores. In a "carrier" of latent tetanus spores an injection of quinine will be followed by a multiplication of tetanus bacilli at the site of inoculation of the quinine.

Equally interesting and important in the ætiology of tetanus is the rôle of ancillary organisms. When an animal succumbs after the inoculation of

soil containing the tetanus bacillus, other organisms in addition to the latter are found in the pus. Vaillard and Rouget isolated several of these organisms and obtained cultures which when mixed with pure spores assisted in the development of the disease just as would the addition of a negatively chemio-tactic substance. Soil containing spores of tetanus only gives rise to the disease provided that it contains such ancillary organisms.

Experiment.—Take a little soil containing tetanus spores and divide it into two portions, one of which acts as the control. Mix the other portion with sterile water and aspirate it into a pipette as far as the constriction. Seal the pipette and heat the contents at 85° C. for an hour. The spores of tetanus can survive this temperature while non-sporing organisms are destroyed. If, now, some of the unheated soil be inoculated into guinea-pigs, the animals will die of tetanus, while guinea-pigs inoculated with the same amount of heated soil will be unharmed.

On the other hand cultures sown aëroically with the same (unheated) soil and inoculated into guinea-pigs give rise to purulent lesions but never to tetanus. A third series of guinea-pigs may be inoculated with a little of the heated soil to which a small amount of an aërobic culture has been added. In this case all the animals will die of tetanus.

SECTION II.—MORPHOLOGY.

1. Microscopical appearance.

The bacillus of tetanus occurs sometimes as spores, sometimes in the non-spore-bearing condition.

A. In young cultures, and in some cases in pus, the organism assumes the form of very slender, elongated rods with square-cut ends measuring 3–4 μ by 0.3–0.4 μ , and showing in the absence of oxygen slow wavy movements which cease when the bacillus becomes spore-bearing.

The non-spore-bearing bacillus is flagellated. The flagella are numerous, wavy and long and are attached laterally to the body of the bacillus (peritrichous) (fig. 261). They can be readily stained by the usual methods (p. 148).



FIG. 259.—*Bacillus tetani*. Pus from a guinea-pig showing a double infection with a coccus. Carbol-blue. (Oc. II, obj. 1/3th, Reich.)



FIG. 260.—*Bacillus tetani*. Broth culture showing spores. Carbol-fuchsin and methylene blue. (Oc. 2, obj. 1/3th, Zeiss.)



FIG. 261.—*Bacillus tetani*. Showing flagella. $\times 1000$.

B. Spore-bearing bacilli will be found in cultures incubated at 37° C. for 36–48 hours and sometimes in pus. Cultures 10 days old consist almost

entirely of bacilli with spores. In cultures incubated at 20° C. or 25° C., spore formation is slower and only commences after the cultures have been incubated for about 10 days.

Spore-bearing bacilli occur as rather short, slender rods with a small sphere situated exactly at one end: the spore is refractile and has a diameter two to four times the width of the bacillus. This is known as the pin form of the bacillus (fig. 260).

In old cultures, the body of the bacillus breaks off and spores and swollen, irregular, dumb-bell shaped involution forms only are found.

Staining reactions.—The bacillus of tetanus is easily stained with the basic aniline dyes, and is gram-positive. If spore-bearing bacilli be stained in the ordinary way the rods and the outline of the spores alone are stained, leaving the centres of the latter unstained and giving the organism its characteristic appearance, which has been compared to a tennis racquet.

The spores may easily be stained by the methods already described (p. 145).

2. Cultural characteristics.

Conditions of growth.—The tetanus bacillus is an anaërobic organism though not so strictly anaërobic as the bacillus of malignant œdema. Growth will take place in media containing small quantities of oxygen and the organism can be trained to grow in a slightly rarefied atmosphere.

Growth takes place at all temperatures between 14° and 43° C. Below 20° C. the growth is very poor. Spores form very slowly below 25° C. The optimum temperature is 38° C. At 42° and 43° C. the bacilli multiply rapidly but few of them form spores.

The tetanus bacillus grows on the ordinary neutral or slightly acid or alkaline media made from broth provided they be made with *fresh broth* (Kitasato). Ordinary fresh beef broth, Martin's broth or Nicolle's medium (*vide infra*) are among the best, while such media as white of egg and fresh serum yield very poor growths.

Debrand has shown that in presence of the *Bacillus subtilis* the tetanus bacillus can be easily cultivated in broth in contact with air. Under these conditions the tetanus bacillus retains its properties and secretes as powerful a toxin as when grown under strictly anaërobic conditions.

Characters of growth. Broth.—Under anaërobic conditions growth is rapid at a temperature of 37° C. After incubating for about 24 hours the medium is generally cloudy and small bubbles of gas will be seen rising to the surface of the medium. The turbidity increases during the next few days and after incubating for about a fortnight growth begins to slacken and a precipitate falls to the bottom of the tube, the broth becoming clear.

During cultivation, hydrogen, nitrogen and hydrocarbons are given off in moderate quantity. The culture has a characteristic but most disagreeable odour, which has been compared to that of burnt hoofs.

The tetanus bacillus forms indol in broth.

Gelatin. Deep stab culture.—A deep stab culture in a tube of gelatin from which the air has been removed gives, after incubating for 4 or 6 days at a temperature of about 20° C., a growth of small cloudy-looking points from which numerous very fine spicules shoot out at right angles to the line of the stab. The cloudiness extends and gradually invades the whole of the gelatin, which commences to liquefy about the tenth day. A flocculent deposit forms at the bottom of the tube and above it the gelatin is clear and liquid. Spores only form when the gelatin has begun to liquefy. Bubbles of gas are also formed.

Single colonies in a Vignal's tube.—Small whitish points appear after incubating for about 4 or 6 days: these soon form cloudy spheres from which fine spicules radiate on all sides. Bubbles of gas appear around the colonies. Liquefaction of the gelatin commences about the tenth or fifteenth day and progresses slowly. The colonies appear as whitish flakes floating in the liquefied gelatin.

Agar.—A deep stab culture in agar incubated at 37° C. rapidly gives rise to a cloudy growth which is not very characteristic. The agar is split by numerous gas bubbles.

Serum.—In stab culture in coagulated serum, covered after sowing with a layer of agar, a cloudy growth results. The serum is not liquefied.

Potato.—The tetanus bacillus grows on potato under anaërobic conditions, but poorly and with difficulty. In an experiment of Vaillard and Vincent the bacillus formed a thin, moist, glistening layer rather like that of the typhoid bacillus and microscopically was seen to be made up of long rods without spores.

Milk.—The bacillus grows in milk and does not coagulate the medium.

SECTION III.—BIOLOGICAL PROPERTIES.

1. Vitality and virulence.

The spores of the tetanus bacillus are very difficult to sterilize. In a closed vessel and in a moist atmosphere they withstand a temperature of 80° C. for 6 hours, 90° C. for more than 2 hours, and the temperature of boiling water for 3 or 4 minutes; but they can be destroyed with certainty by boiling for 8 minutes.

Spores dried and mixed with soil and kept exposed to the air but in the dark, retain their vitality and virulence for several months (Kitasato), but if dried on paper or silk thread and exposed to air and diffused daylight or direct sunlight they rapidly undergo profound modification.

These modifications vary with the length of time of exposure. At first, the germination of the spores is slower and their growth less rapid. Later they develop into non-sporing, non-pathogenic bacilli and finally perish. All these changes can be brought about in less than a month. But when exposed to light alone in the absence of air the dried spores are more resistant; in the experiments of Vaillard and Vincent they were still able to germinate and give rise to spore-bearing toxicogenic bacilli after more than 2 months, during which they were exposed to sunlight for 59 hours.

The tetanus bacillus in the superficial layers of the soil is evidently continuously exposed to these destructive and attenuating influences, and it rapidly disappears if by *passage* through the alimentary canal of herbivora it does not find conditions favourable to life and multiplication (Sanchez Toledo and Veillon).

If dried in pus or albuminous fluids or on porous substances—such as splinters of wood taken from tetanus infected wounds—the bacillus retains its virulence and vitality for a long time.

2. Toxin.

Faber, and after him Vaillard and Vincent, by filtering broth cultures of the organism obtained a very toxic liquid the inoculation of which into animals gave rise to a typical attack of tetanus.

Preparation of tetanus toxin.—Experience has shown that the composition of the medium has considerable influence on the toxin content of the product. Peptone-beef-broth is the best medium for preparing tetanus toxin.

Sow the bacillus in fresh peptone-beef-broth and arrange the flask as

described on p. 94. Incubate at 38° C. anaerobically for 4 or 5 weeks then filter the culture through a Chamberland bougie. In this way a very toxic liquid is obtained of which a dose of $\frac{1}{4,000}$ c.c. is fatal to a mouse when inoculated sub-cutaneously.

Marie advised the addition of a little gelatin to the broth.

Ch. Nicolle proposes the following medium :

| | | |
|------------------------------------|-----|--------|
| Water, - - - - - | 100 | c.c. |
| Peptone, - - - - - | 2 | grams. |
| Gelatin (extra quality), - - - - - | 1 | gram. |
| Salt, - - - - - | 0.5 | " |

Grow beneath a layer of vaseline oil (p. 97). This medium yields a toxin in 6-10 days which is fatal to mice in doses of $\frac{1}{10,000}$ c.c.

The toxicity of broth cultures may also be increased to a remarkable degree by making use of the property possessed by the organism of growing in a medium which has already served for the growth of the bacillus and in which it has elaborated its toxin.

After incubating tetanus bacilli in broth for 3 weeks filter the culture through a bougie and sow the filtrate with the bacillus. Incubate again for 3 weeks and after a second time. To the filtrate, add about $\frac{1}{3}$ th of its volume of fresh sterile broth and sow a third time with the bacillus. This third culture when filtered gives a very powerful toxin.

Action of tetanus toxin on living animals.—The inoculation of very small doses of toxin is fatal. The most powerful toxins obtained by Vaillard and Vincent by the methods just described will kill guinea-pigs in doses of 0.001 c.c. and mice in doses of 0.00001 c.c.

If a sub-lethal dose of toxin be inoculated a local tetanus results involving only the muscles in the neighbourhood of the site of inoculation.

Tetanus toxin diffuses very quickly through the tissues. If a fraction of a drop of the toxin be inoculated towards the distal end of a rat's tail, in a part, that is, where absorption is very slow, the tail may be cut off 2 or 3 cm. on the proximal side of the site of inoculation three-quarters of an hour after the operation without in any way affecting the course of the disease; the animal dies almost as quickly as the control.

Tetanus toxin inoculated sub-cutaneously or intra-muscularly only passes in minute quantities into the blood but is absorbed by the peripheral expansions of the neurones and carried gradually to the cells of the central nervous system, producing in them lesions which are responsible for the characteristic spasms. Tetanus toxin has a special affinity for the nerve cells. This can be demonstrated *in vitro*.

Wassermann and Takaki, by mixing an emulsion of cerebral substance in normal saline solution with tetanus toxin and centrifuging the mixture, obtained an opalescent solution containing almost no toxin at all. The toxin had not been destroyed by this treatment but was simply fixed by the nerve substance in the same way as a dye might be fixed to a fabric. The toxin merely combines loosely with the cerebral substance from which it may be again set free; its nature is not altered (Metchnikoff and Marie, Danysz). Neutral mixtures of brain emulsion and tetanus toxin become toxic on keeping: the toxin diffuses into the surrounding liquid and is again free in solution. On the other hand, toxic mixtures of toxin and anti-toxin become in time less toxic (Knorr). An emulsion of carmine in normal saline solution acts in a similar manner: provided that it has not been sterilized in steam nor macerated it fixes the toxin and renders the filtrate harmless (Stoudensky).

In these mixtures the toxin is fixed by the particles of cerebral substance or carmine respectively and, if injected into animals, it has no time to diffuse before the leucocytes absorb and destroy it.

In the living tissues, tetanus toxin induces phenomena similar to those just studied *in vitro*. Tetanus toxin inoculated sub-cutaneously into guinea-pigs is fixed after the lapse of some hours by the cells of the central nervous

system and it is then that the symptoms of tetanus show themselves. Direct proof of this fact is afforded by the severity of the symptoms produced by the inoculation of the toxin into the intact nervous tissue. For example, rabbits are very resistant to sub-cutaneous or intra-venous inoculation of tetanus toxin; to produce a fatal result in 4 days a dose of 2.5 c.c. must be used. But a dose of 0.1 c.c. of the same toxin inoculated intra-cerebrally is fatal in less than 20 hours. In this case the disease runs a special course—the cerebral tetanus of Roux and Borrel. The animal exhibits an extraordinary degree of excitability, is subject to hallucinations, to sudden fears, and, in short, to mania. Later, intermittent convulsive crises, motor troubles and polyuria appear; these symptoms terminate in the death of the animal. Guinea-pigs and rats suffer similarly from cerebral tetanus after the inoculation of very small doses of toxin into the brain.

The resistance of rabbits to sub-cutaneous and intra-venous inoculation is not, therefore, due to a relative insusceptibility of the nerve cells but to the fact that much of the toxin injected does not reach the cells, being destroyed (probably by the phagocytes) in some part of the body as yet undetermined (Roux and Borrel).

Technique of intra-cerebral injection.—After incising the soft parts make a hole in the skull with a gimlet being careful to protect the dura mater from injury: then plunge the needle of the syringe to the desired depth—previously determined by a probe—and inject the toxin. The animals stand these intra-cerebral inoculations very well and it is possible to inject 8 drops of sterile broth in 2 stabs into a guinea-pig's brain without producing symptoms. In a rabbit 0.5 c.c. can be similarly inoculated.

Nature of tetanus toxin.—The product of the tetanus bacillus (or, tetanospasmin) is extraordinarily toxic.

Evaporated *in vacuo*, 1 c.c. of a toxin which is fatal to mice in doses of 0.00001 c.c. gives a constant residue of 0.04 gram. On calcining, this residue loses 0.025 gram which represents the organic matter. This organic matter consists largely of inactive substances such as peptone, etc. (Vaillard and Vincent): but assuming for the moment that the whole of the organic matter consists of toxin it follows that these 25 mg. of toxin are sufficient to kill one hundred thousand mice; on this assumption the lethal dose of the active principle for a mouse is 0.000,000,25 gram. And the premise of the argument shows that this is a very conservative estimate.

Tetanus toxin has all the characteristics of enzymes or diastases. Chemically, it is very similar to diphtheria toxin. It undergoes considerable change if heated to 65° C. for half an hour and is completely destroyed by heating for 3 hours at 80° C.

Stored in sealed vessels in the dark and away from air, the toxin retains its virulence for a long time. The toxin is rapidly weakened by exposure to the air and diffused light and entirely loses its virulence in a few days if exposed to direct sunlight and air.

Tetanus toxin has the property of adhering to amorphous precipitates produced in liquids in which it is dissolved.

The addition of calcium chloride to the toxin precipitates calcium phosphate and a part of the toxin is carried down with the precipitate. A minute portion of this precipitate—as large as a pin's head—if carefully washed and inserted beneath the skin of a guinea-pig, will cause the death of the animal from tetanus in 30 hours. After precipitation a large amount of toxin still remains in solution in the liquid.

If a little tetanus toxin obtained by filtration be added to a tube of sterile gelatin the medium will be liquefied in a few days. The phenomenon is due to the presence in the toxin of a peptonizing diastatic ferment. This ferment does not appear to be identical with the toxic principle.

Evaporated at 25° C. *in vacuo* over sulphuric acid the toxin leaves a brown,

amorphous, extremely virulent residue. 90 per cent. alcohol dissolves a small quantity of this residue, and leaves after evaporation a whitish, non-toxic substance having a waxy smell. The remainder of the residue not dissolved by alcohol is readily soluble in water and produces typical symptoms of tetanus in guinea-pigs: it can be precipitated from its aqueous solution by alcohol. The active substance contained in the residue dialyzes slowly.

Tetanolysin.—Ehrlich and Madsen have demonstrated the presence of an hæmolysin in filtered cultures of the tetanus bacillus. Tetanolysin differs from tetanus toxin: it is highly unstable and is destroyed if heated for 20 minutes at 50° C. or for some hours at 20° C.

It dissolves the red cells of domestic animals and especially those of the rabbit and horse. Animals immunized with filtered cultures rich in hæmolysin elaborate an antitetanolysin simultaneously with tetanus antitoxin.

Detection of toxin in the living tissues.—When, in a case of traumatic tetanus, the bacillus cannot be found, an attempt may be made to demonstrate the presence of toxin in the blood by inoculating a few cubic centimetres of the patient's serum into a mouse. The animal may die but the method is not to be relied upon and should not in any case be adopted when the patient has been treated with antitoxin.

3. Vaccination.

(i) Behring and Kitasato failed in their attempts to immunize animals by repeated inoculations of small doses of tetanus toxin. They obtained more satisfactory results, however, when they inoculated rabbits with a mixture of toxin and iodine terchloride.

Brieger, Wassermann and Kitasato by inoculating repeated and progressively increasing doses of cultures attenuated by growing on thymus-broth only obtained unreliable results. Tizzoni and Cattani succeeded in immunizing rabbits by inoculating them with attenuated cultures.

Vaillard was able to immunize rabbits with toxin which had been partially deprived of its toxic properties by heat. Rabbits were inoculated intravenously on several occasions with 10 c.c. of toxin heated for 1 hour first at 60° C. then at 55° C. and finally at 50° C. To increase the degree of immunization, progressively increasing doses of non-heated toxin were then given viz.: first 5 c.c. then 10 c.c. followed by doses of 15 and 30 c.c. Guinea-pigs were immunized in the same way.

(ii) Roux and Vaillard prefer to use, for the purpose of vaccination, toxin to which a solution of iodine has been added (*vide Diphtheria*). Their toxin is obtained as described above and it should kill mice in doses of 0·00025 c.c. It is mixed with Gram's solution immediately before use. The immunization of a rabbit and of a horse will be described in illustration of the method.

Immunization of a rabbit.—Inoculations given sub-cutaneously:—

| | |
|---------|--|
| 1st day | 3 c.c. of toxin mixed with 1 c.c. Gram's solution. |
| 5th .. | 5 c.c. of toxin + 2 c.c. of Gram's solution. |
| 9th .. | 12 c.c. of toxin + 3 c.c. of Gram's solution. |

On the seventeenth day the immunization of the animal is complete. Its serum is antitoxic. It can then be inoculated at intervals of a week with progressive doses of 5, 10, 15, 20, 30 and 40 c.c. of pure toxin. Later, the inoculations may be given intra-venously or intra-peritoneally, and finally, a dose of as much as 100 c.c. of toxin can be given at a single inoculation.

Immunization of an horse.—The treatment is begun with a dose of 1-5 c.c. of a mixture of equal parts of toxin and Gram's solution sub-cutaneously. The inoculations are repeated every 3 or 4 days. At the end of a fortnight 10 c.c. of a mixture of 2 parts toxin and 1 part iodine solution are inoculated and the quantity is gradually increased until about the twenty-fifth day the injection of pure toxin is com-

menced, doses first of 10, then of 15 and 20 c.c. being given every 2 or 3 days. At the end of 6 weeks increasing doses of 50, 100, 150 c.c. can be inoculated into the jugular vein. After these enormous doses intra-venously the horse may suffer from temporary disturbances of health such as sweating, colic, diarrhoea and rise of temperature (1° or 2° C.). Immunization is complete in about 3 months.

The blood may be collected for therapeutic purposes 10 days after the last inoculation.

(iii) Behring advises inoculating the horse in the first instance with a mixture of toxin and antitoxin prepared in such a way that its inoculation into small animals leads to a slight illness. The treatment is subsequently continued by inoculating pure toxin. This method is based upon that described for the preparation of diphtheria antitoxin (p. 265).

(iv) Vaillard immunized a rabbit by injecting it sub-cutaneously on several occasions with very small doses of the spores of tetanus free from toxin but mixed with a little lactic acid. An animal treated in this way resists the inoculation of ordinarily lethal doses of tetanus toxin but its blood shows no appreciable antitoxic property.

4. Serum therapy.

The antitoxic properties of the blood of animals immunized against tetanus were demonstrated by Behring and Kitasato.

The blood of an immunized rabbit is capable of neutralizing tetanus toxin. This property is present in serum free from all cellular elements and is demonstrable both *in vivo* and *in vitro*. It is not found in the blood of non-immunized animals.

The blood of naturally immune animals, such as the fowl, possesses no antitoxic property though it easily acquires the property if the animal be inoculated with tetanus toxin. After two or three inoculations of 20 c.c. each into the peritoneum of a fowl the blood of the animal exhibits, after the lapse of 12–20 days, powerful antitoxic properties. Similarly, the blood of rabbits immunized by the inoculation of small doses of spores does not possess antitoxic properties but these properties may be conferred by inoculating the animal with tetanus toxin.

The milk of immunized animals is also actively antitoxic. The white of egg of fowls which have been treated with toxin is not antitoxic.

Preparation of tetanus antitoxin.—For the practical application of serum therapy to man and animals the serum of the horse is used. For laboratory work, rabbits are a good source of antitoxic serum.

Horses are immunized in the manner described above.¹

After 3 months the serum of the horse is ready for use. The antitoxic property is maintained and even increased by inoculating large doses of toxin into the jugular vein or beneath the skin of the animal at intervals. After each inoculation the antitoxic strength of the serum is lowered for the time being; the horse therefore must not be bled until 12 days have elapsed.

The serum preserves its properties when dried *in vacuo*. In this way, a very powerful serum may be kept indefinitely and in small bulk.

Standardization of the antitoxin.—In determining the antitoxic content of a serum the notation of Roux and Behring is used, which calculates the content according to the volume of serum required to immunize 1 gram weight of mouse. A serum is said to be active in $\frac{1}{10,000,000}$ if 0.1 c.c. of the serum is sufficient to immunize 100 kg. of mice or when a mouse weighing 20 grams is rendered immune by the inoculation of 0.000,002 c.c. of serum.

In vitro the antitoxic content of the serum is measured by the quantity

¹ For full details of technique, reference should be made to the section on immunization against diphtheria.

of serum required to neutralize a given volume of toxin of known strength. The immunizing property of a serum does not increase *pari passu* with the antitoxic strength.

Properties of tetanus antitoxin.—*In vitro* the serum of immunized animals mixed with tetanus toxin neutralizes the latter instantly. The volume of serum required to neutralize a given volume of toxin varies with the antitoxic content of the former. Antitoxic serums can be obtained of which 0·000,01 c.c. neutralizes 100 fatal doses of toxin (Pasteur Institute, Paris).

It may be again mentioned that in a toxin-antitoxin mixture, the toxin is not destroyed (p. 224); the toxin has merely entered into unstable combination with the antitoxin and its toxic properties are easily brought into evidence again. Thus, for example, if a guinea-pig already inoculated with a culture of *M. prodigiosus* or *B. coli* be inoculated with a toxin-antitoxin mixture which is harmless for a normal animal the inoculated animal soon shows symptoms of tetanus intoxication.

The inoculation into the peritoneum of a guinea-pig of a dose of serum (active in $\frac{1}{10,000,000}$) equivalent to the three hundred and forty-fifth part of the weight of the animal, rapidly leads to the manifestation of distinct antitoxic properties in its blood. The blood of a rabbit inoculated with $\frac{1}{175}$ th part of its weight of serum is antitoxic and has marked immunizing properties.

The sub-cutaneous inoculation of 1 c.c. of antitoxic serum administered 10–40 minutes before the inoculation of 0·0066 c.c. of toxin (a dose fatal to the control animals in 48 hours) protects guinea-pigs against tetanus. But in animals inoculated with the toxin less than 40 minutes after the inoculation of serum the protection is not complete. Symptoms of tetanus result the severity of which is inversely proportional to the length of time elapsing between the inoculation of serum and toxin; the longer the interval the less severe the symptoms. But the animals always recover.

It is a much more difficult matter to prevent the onset of tetanus if serum be given only after the inoculation of toxin, during, that is to say, the period of incubation. Similarly, it is less easy to prevent the affection resulting from the multiplication of the bacillus in the tissues.

Immunity is developed in half an hour or so after the inoculation of serum, but it does not last long, rarely exceeding a fortnight or a month in the case of laboratory animals and a week in the case of the human subject.

Roux and Vaillard summarize their investigations on the prevention of tetanus as follows:

“1. Anti-toxic serum even in extremely small doses will certainly protect against tetanus if inoculated before the toxin. *The immunity conferred by the serum is transitory.* It begins to diminish after about a fortnight and disappears altogether in about 6 or 7 weeks.

“2. When serum and toxin are inoculated at the same time a local tetanus always results however large the dose of serum.

“3. When the serum is inoculated after the toxin but before the appearance of any symptom of tetanus a local tetanus is always observed. The longer the administration of serum is delayed the larger must be the quantity administered. After the lapse of a certain length of time—varying in different animals—prevention is impossible even though very large quantities of serum be used.

“4. Tetanus develops more or less rapidly and is therefore more or less easy to prevent according to the site of inoculation of the toxin. (Animals inoculated in the paw are more resistant than those inoculated beneath the skin of the thorax or abdomen.)

“These conclusions refer to moderate doses of toxin.

“5. When infection is due to the bacilli multiplying in the tissues, prevention again depends upon the amount of serum inoculated and on the time elapsing between the moment of infection and the administration of the serum. When animals are

inoculated in such a way as to suffer from an attack of the disease which rapidly runs its course the serum will in most cases be ineffective. It may succeed in slowly developing infections but in these cases again the prevention of the disease is not always certain unless the site of infection be excised. The disease may appear to be checked but it is liable to break out again and terminate fatally even after a considerable lapse of time."

The cure of the disease after the symptoms have manifested themselves is therefore always difficult because the appearance of the symptoms is itself evidence that the nerve elements are already involved. Antitoxin neutralizes toxin circulating in the body but is totally ineffective against existing lesions. Very large doses of the more powerful serums are without effect on a rapid case of tetanus: such doses render the blood antitoxic and immunizing but the disease pursues its course. In less severe cases the serum prolongs life but unless the focus of infection be removed the disease will develop so soon as the antitoxic power of the blood shall begin to diminish.

In man also, the serum therapy of tetanus has yielded but indifferent results. The treatment fails in the more severe forms of the disease. It only seems to give positive results in sub-acute or chronic cases, and it is well known that these cases when treated by the ordinary methods often terminate in recovery. However that may be, the serum treatment of tetanus is harmless and should be adopted in all cases of the disease in man.

Roux and Vaillard define the course of treatment in cases of tetanus in man as follows:

"Inoculate at once, and without waiting, 100 c.c. of a very powerful serum, and if possible excise the infected area. Another 100 c.c. should be administered on the following day and on the day after that. If the symptoms are checked, and especially if the focus of infection has not been excised, give a further dose of serum ten days later to obviate any recurrence of the disease such as has been described as taking place in animals."

In view of the failure of treatment, attention has been directed to the prevention of the disease in man and animals. Whenever a contused wound soiled with earth has to be treated it is well to inoculate, as a precautionary measure, 20-30 c.c. of antitetanus serum and the inoculations should be repeated in doses of 10-15 c.c. every week until all danger of tetanus has vanished. Nocard, in veterinary practice, has obtained very good results with prophylactic inoculations in cases of wounds of the foot and after castration.

Calmette has shown that animals can easily be immunized against tetanus by sprinkling a small wound involving the whole thickness of the dermis with dry powdered serum (*vide ante*). As a prophylactic measure, he advises the use of dried serum for dressing wounds liable to be infected with tetanus and especially in those countries where the disease is rife.

Intra-cerebral inoculation.—These facts render it difficult to understand how tetanus toxæmia continues to develop in animals which have been treated with antitoxin and whose blood is prophylactic and antitoxic. The researches of Roux and Borrel have thrown some light on the mode of action of antitoxin and have given a new impetus to the serum treatment of the disease.

A neutral mixture of toxin and antitoxin is harmless to the nerve cells. It can be inoculated into the brain of a rabbit without any untoward incident occurring. Again, a rabbit immunized with serum, while unaffected by the sub-cutaneous inoculation of a quantity of toxin which is five times the lethal dose for an untreated animal, will nevertheless die if 0.1 c.c. of toxin be inoculated into the brain.¹ However, its blood is so antitoxic that a few

¹ This quantity when inoculated sub-cutaneously is absolutely without any effect on a normal rabbit.

drops neutralize considerable quantities of toxin. And further, a trace of the blood accidentally spilt in the path of the inoculating needle as it traverses the brain is sufficient to neutralize the toxin and the animal does not die.

Antitoxin given sub-cutaneously or intra-venously remains in the blood. It has no affinity for the nerve elements. These latter, on the other hand, pick out and fix the toxin (*vide ante*). In an animal suffering from tetanus the antitoxin given sub-cutaneously or intra-venously limits the poisoning by destroying the toxin circulating in the blood but it does not come in contact with the toxin already fixed by the nerve elements, which diffuses from cell to cell and so extends its ravages. Antitoxin should, therefore, not be inoculated into the blood of those suffering from the disease but rather into the nerve centres. Proof of the correctness of these views is afforded by the results of direct inoculation of antitoxin into the brain.¹ Roux and Borrel took a number of guinea-pigs and inoculated them sub-cutaneously with a lethal dose of toxin. Twenty-four hours later these animals showed symptoms of tetanus. Some of them were then inoculated with 1 c.c. of serum sub-cutaneously and in spite of this they died. The remainder were treated with 4 drops of the same serum in each cerebral hemisphere with the result that the disease was arrested and the animals recovered, though some of them suffered from localized spasms for a long time. In these cases the inoculation preserved the upper parts of the cord against the diffusion of the toxin but was without effect on the lesions already present in the lower parts; hence the persistence of the spasms present at the time of the therapeutic inoculation. Similar experiments showed that when the upper part of the cord is affected the inoculation is too late and fails to save the life of the animal.

The cure of human tetanus would seem to follow from these investigations. Unfortunately, in practice, the results are very inconstant. Against the rare cases of recovery following intra-cerebral inoculation of antitoxin recorded by Lucas-Championnière, Girard, Chauffard, Nimier, Ledoux, Maunoury, Holub and others have to be recorded the numerous failures and even rapidly fatal accidents reported by other observers (Vallas, Girard, Tailhefer and others).

5. Agglutination.

The serum of normal persons does not agglutinate the tetanus bacillus. In cases of tetanus in man, the blood does not acquire agglutinating properties (Courmont). The same is true of laboratory animals.

Normal horse serum agglutinates the tetanus bacillus feebly (1 in 50 to 1 in 100). The serum of an highly immunized horse agglutinates the bacillus in dilutions of 1 in 2,000 and even in 1 in 50,000.

The inoculation of antitetanus serum only confers an agglutinating property when given in considerable doses (Courmont).

SECTION IV.—DETECTION AND ISOLATION OF THE TETANUS BACILLUS.

When it is desired to isolate the bacillus from or to detect its presence in soil, a small quantity should be inoculated into a guinea-pig; the bacillus if present can be easily demonstrated in and isolated from the tissues after death.

¹ Inoculation of antitoxin into the spinal cord is difficult to effect without producing lesions and moreover does not appear to be as efficient as intra-cerebral inoculation. Sub-arachnoid inoculation does not give satisfactory results.

The examination of the dead bodies of man or the lower animals for the tetanus bacillus should be strictly limited to the site of the infection.

It has already been pointed out that the bacillus only exceptionally becomes generalized in the tissues of inoculated animals. In man, cases have been recorded in which the bacillus has been found in the blood and also, but very rarely, in the lymphatic glands at a distance from the infected wound.

The investigation should take the following lines :

(a) **Microscopical examination.**—Examine the pus or membranous material from the wound in films stained with carbol-crystal-violet or dilute carbol-fuchsin and by Gram's method.

It is often necessary to prepare several films before the bacillus can be found, as it occurs in very small numbers and moreover its presence may be masked by the large number of other organisms present. Occasionally, the reverse is the case and the tetanus bacillus occurs in fairly large numbers while other organisms are scanty. Fig. 259 is a reproduction of a film of pus from a case of this kind in which the presence of the bacillus was easily and rapidly demonstrated.

If microscopical examination fail to reveal the bacillus there is no justification for concluding that the organism is not present; cultures must then be sown with the material.

(b) **Cultures. Isolation.**—Kitasato was the first to devise a means of isolating the tetanus bacillus in pure culture from pus containing the organism. The method is based upon the resistance of the spore to heat and upon the anaërobic properties of the bacillus, and is as follows :

1. Sow the pus or other material from the infected wound in beef broth and incubate *in vacuo* at 38° C.

2. After 5 days the broth now cloudy contains together with other anaërobic bacteria numerous pin-shaped [drum-stick] bacilli, which are readily identified as tetanus bacilli. In order to isolate the organism, pipette a little of the impure culture into a fine tube, such as the narrow part of a Pasteur pipette, seal the tube at both ends in the flame and heat at 100° C. for 1 or 2 minutes. The spores of the tetanus bacillus survive while most of the other organisms are killed.

3. Sow the contents of the heated tube in broth and incubate *in vacuo* : in the resulting growth the tetanus bacillus predominates and may even be in pure culture. By thus alternately heating and cultivating two or three times the bacillus can be isolated in pure culture.

4. Still, it often happens that the tetanus bacillus cannot be altogether freed from the bacillus of malignant œdema and another anaërobic bacillus which is not pathogenic and the spore of which is not strictly terminally situated. In a case such as this the experiment will have to be completed by isolation in a Vignal's or Veillon's tube (p. 103).

(c) **Experimental inoculation.**—Inoculate a little of the pus or a small fragment from the infected wound directly into guinea-pigs or mice. Symptoms of tetanus soon follow the inoculation. Cultures also should be tested by inoculation into animals.

Bacillus botulinus.¹

The *Bacillus botulinus* was isolated by van Ermengem from some ham the consumption of which at Ellezelles in December 1895 was followed by the symptoms of botulism² in a number of persons who had partaken of it and of whom three died.

Römer investigated a similar epidemic at Alsfeld and isolated an organism practically identical with van Ermengem's bacillus.

¹ This section has been added.

² *Botulus*, a sausage.

Fischer and Landmann have also recorded an outbreak of food poisoning at Darmstadt attributable to the same organism. In this epidemic the illness was traced to some preserved peas mixed with which were some fragments of meat. Twenty-one persons were affected of whom eleven died.

Van Ermengem recovered the bacillus from the spleen of a patient who had died of botulism. Kempner isolated the *Bacillus botulinus* from the excreta of pigs.

The *Bacillus botulinus* is now generally accepted to be the specific cause of botulism. It appears to be normally a saprophyte which does not multiply to any extent in the living body. Botulism is regarded therefore as a toxæmia due to the consumption of meat which has been accidentally contaminated with the *B. botulinus* and in which the toxin is present at the time it is eaten.

The toxin is quite easily destroyed by boiling and by other methods of cooking so that the danger of botulism is limited to the consumption of uncooked or very insufficiently cooked food; and Sacquépée points out that the symptoms of botulism only follow the consumption of "preserved" foods, that is to say, of such articles of diet as sausages which are made some months before they are eaten, ham, meats preserved in tins and bottles, game pies, etc.

Experimental inoculation.—The inoculation of a large quantity (10–20 c.c.) of an emulsion of a culture of the bacillus or of an infected food proves fatal to rabbits in 48 hours. Small doses lead to a chronic illness which however ultimately terminates in the death of the inoculated animal.

Guinea-pigs and mice are also susceptible.

The most characteristic results are obtained with cats. The inoculation of cultures of the *Bacillus botulinus* into cats is followed by a typical attack of botulism with its characteristic symptoms of bulbar paralysis.

Morphology.—The *Bacillus botulinus* is a straight, rod-shaped, slightly motile organism with rounded ends. It measures from $4-9\mu \times 0.9-1.2\mu$. The bacilli are often seen in pairs and in short chains and resemble closely the bacilli of malignant œdema and quarter ill.

Under favourable conditions, e.g. on an alkaline gelatin medium incubated at $20^{\circ}-25^{\circ}$ C. the bacillus forms oval spores; these are generally terminally situated and are rather wider than the bacillus. Spores are not formed at 37° C.

The *Bacillus botulinus* stains with the ordinary aniline dyes and is gram-positive though relatively somewhat easily decolourized.

Cultural characteristics.—The bacillus is a strictly anaërobic organism. The optimum temperature of growth is below that of the majority of pathogenic micro-organisms, viz. $20^{\circ}-30^{\circ}$ C.

The bacillus will not grow except on media made with meat, and pig's flesh is better than that of either cattle or sheep.

In *agar* media it produces a considerable amount of gas with a strong odour of butyric acid.

In *gelatin* the growth is characteristic. Circular, transparent, yellowish-brown colonies appear in 4–6 days and around each colony the medium is liquefied. The gas which is formed either splits the medium or, if the latter be largely liquefied, rises to the surface and forms a layer of bubbles.—In *stab culture* the growth assumes an arborescent form (Distaso).

In *milk* the bacillus grows slowly but does not coagulate the medium (Distaso). Von Hibler however finds that the *B. botulinus* first coagulates the milk and then peptonizes the clot.

Vitality.—The spores of the *Bacillus botulinus* retain their vitality for about a year. They can be destroyed in 15 minutes at 85° C. and in 30 minutes at 80° C.

Toxin.—Van Ermengem was the first to show that the *Bacillus botulinus* produces an extra-cellular toxin which has all the generic properties of the

extra-cellular toxins of diphtheria and tetanus. Its action is specific and it always gives rise to symptoms of botulism; moreover the illness which follows its administration is always preceded by an incubation period.

Preparation.—The toxin may be prepared by any of the methods described for the preparation of tetanus toxin.

Properties.—The toxicity of the toxin is lowered by exposure to light and air and by heating at 58° C. for 3 hours. Its properties are destroyed altogether by heating at a temperature of 100° C.

The toxin is highly poisonous. For man the lethal dose is said to be 0·035 mg.; rabbits succumb in 72 hours and guinea-pigs in 4–5 days after being inoculated with quantities of 0·005 c.c.; in cats a dose of 0·5 c.c. of a filtered culture produces the characteristic symptoms of botulism and death takes place in about 8–10 days.

The toxin acts specifically on the nervous system.

Kempner and Pollack, and Marinesco have demonstrated changes of toxic degeneration in the anterior columns of the cord. Kempner and Schepilewski have shown that the toxin combines with the tissues of the brain and spinal cord and that an emulsion of these tissues has the property of neutralizing the toxin—cf. Wassermann and Takaki's experiments on tetanus toxin (p. 542).

Charrin and Bardier have shown that the toxin acts also specifically on the heart.

Antitoxin.—Kempner by adopting the ordinary procedure (*vide* Diphtheria and Tetanus) has been able to prepare an antitoxic goat serum. Unfortunately it would appear that to obtain any curative effect in animals the antitoxin must be administered within 12 hours of the administration of the toxin so that it seems probable that the use of the antitoxin in medical practice will not yield any very striking results.

CHAPTER XXXVII.

THE BACILLUS OF QUARTER ILL. (BACILLUS CHAUVÆL.)

Introduction.

Section I.—The experimental disease, p. 552.

1. Susceptible animals, p. 552.
2. Methods of infection, p. 553.
3. Symptoms and lesions, p. 553.

Section II.—Morphology, p. 554.

1. Microscopical examination and staining reactions, p. 554.
2. Cultural characteristics, p. 555.

Section III.—Biological properties, p. 556.

1. Vitality and virulence, p. 556.
2. Vaccination, p. 556.
3. Toxin, p. 558.
4. Serum therapy, p. 559.
5. Agglutination, p. 560.

THE bacillus of quarter ill, symptomatic anthrax or black quarter was discovered by Arloing, Cornevin and Thomas.

Quarter ill is a disease of cattle and also, but rarely, of sheep and goats; other animals are not subject to the spontaneously contracted disease. Cattle are only affected between the ages of 4 months and 5 years; in the early weeks of life they are immune and again become insusceptible after 5 years of age.

The virus is present in soil and infection takes place through the skin, trachea and probably the alimentary canal (Arloing). Epizootics occur generally in the summer and are particularly prevalent in certain districts: for instance in the Pyrenees, in the district of Haute Marne, and in Switzerland. The disease is almost always fatal and is responsible for a heavy mortality among cattle.

Quarter ill has the clinical symptoms of a septicæmia: the temperature is raised, the animal is dull, loses its appetite and ceases to chew the cud: swellings appear on the limbs, in the angle of the jaws, in the throat, on the thorax and in the testicles; the swellings most commonly involve the neighbouring muscles, where they rapidly grow to a very large size becoming emphysematous and crepitant in the centre; the œdema increases peripherally and the animal dies in 3-5 days.

SECTION I.—THE EXPERIMENTAL DISEASE.

1. Susceptible animals.

Guinea-pigs, oxen and sheep are very susceptible to experimental inoculation: goats less so. Donkeys and horses suffer from a painful œdematous swelling at the site of (sub-cutaneous) inoculation but rapidly recover.

Rabbits are immune, but their immunity can easily be overcome (Roger, Leclainche and Vallée).

If the site of inoculation be traumatized or if a little lactic acid or a small quantity of a culture of *Micrococcus prodigiosus* be inoculated with the bacillus the resistance

of the tissues is broken down and the phagocytic action of the leucocytes hindered, with the result that a septicæmic condition develops. Leclainche and Vallée obtained in this way cultures very virulent for the species, 3 c.c. of which subcutaneously injected was sufficient to cause death.

Mice, rats, dogs, pigs, cats and birds are immune.¹

2. Methods of infection.

The *Bacillus chauvæi* being a strict anaërobie only grows when inoculated deeply into the tissues, and does not infect superficial wounds.

The influence of the site of inoculation is very marked. The same dose of the virus which will kill an ox when inoculated into the cellular tissues of the body will set up merely a benign infection if inoculated into the connective tissue of the neck.

In the latter case however if the inoculated part be warmed the bacillus will multiply and the animal may die.

The influence of temperature is emphasized by the fact that frogs under normal conditions resist infection but succumb to the disease if kept in the incubator at 25° C. after being inoculated.

The inoculation of a virulent virus into the veins of an ox merely leads to a temporary rise of temperature: but if at the time of inoculation a trace of the virus gain access to the perivascular tissues a fatal septicæmia ensues. Infection may also be established by rupturing a blood vessel after intravenous inoculation (Arloing).

The disease may be produced experimentally in several ways:

(i) **By the inoculation of cultures.**—If ordinary cultures be inoculated the result will be uncertain, but if young cultures in Martin's broth be used infection will certainly follow: three or four drops inoculated beneath the skin will kill a guinea-pig (500 grams) in 18–24 hours (Leclainche and Vallée).

(ii) **By inoculation of infected blood.**—Blood from the heart of a guinea-pig or sheep recently dead of the disease should be sealed up in pipettes, incubated for 48 hours and then used for inoculation.

(iii) **By inoculation of serous exudates. Method recommended.**—The fluid from the local oedemata may be inoculated without heating: take a portion of one of the swellings and crush it up in a mortar with a little sterile water and inoculate the emulsion. The dried exudate (Arloing's powder, *vide infra*) may also be used: in this case grind up a little of the powder with a few drops of sterile water and add a trace of lactic acid.

(iv) **By inoculation of spores alone.**—By applying methods similar to those described in the chapter on malignant oedema (Chap. XXXVIII.), Leclainche and Vallée have shown that the inoculation of spores free from toxin does not lead to the death of the animal: but the spores, like those of the bacillus of malignant oedema, will, if protected from the action of the phagocytes, germinate and originate a fatal disease; certain substances and certain organisms (e.g. *Staphylococcus aureus*) will also assist the germination of the spores and so favour infection.

3. Symptoms and lesions.

The disease produced experimentally in the guinea-pig will be taken as the type.

If the material be inoculated into the muscles of the thigh a painful and

¹ It has been suggested that the bacillus of malignant oedema and the bacillus of quarter ill are identical species. This position however cannot be maintained, for apart from morphological and cultural differences, they differ widely in their pathogenicity; all the animals which have just been mentioned as immune to the latter bacillus are susceptible to the bacillus of malignant oedema.

characteristic swelling soon appears surrounded by an œdematous infiltration which rapidly encroaches on the abdominal wall. The animal curls itself up and does not move: its coat is dull and rough and the hair can be easily pulled out from over the œdematous area: death takes place 2 or 3 days after inoculation.

Post mortem.—The characteristic appearances are limited to the local lesion. The site of inoculation is marked by a swelling, and the neighbouring connective tissue is infiltrated with an exudate rich in red cells; the muscles are yellowish or dull red in colour while the fibres are vitreous and degenerated. The centre of the swelling is black and sanious and contains bubbles of gas. The lesions have a peculiar odour, which Arloing compared to that of rancid butter, and contain numerous bacilli. The area of œdema extends for a variable distance around the swelling and invades the abdominal and thoracic walls, and the exudate is rich in bacilli but contains no leucocytes. The inguinal glands are œdematous and swollen. In the peritoneal cavity there is a small quantity of a slightly cloudy exudate containing numerous bacilli and the intestine is frequently congested. The

FIG. 262.—The bacillus of quarter ill. Scraping from muscle—Dilute carbol-fuchsin. (Oc. II, obj. A₁₃h, Reich.)

blood is almost unaltered in appearance: during life bacilli cannot be found on microscopical examination: after death they are present though few in number even after incubation at 37° C.

SECTION II.—MORPHOLOGY.

1. Microscopical appearance and staining reactions.

The bacillus of quarter ill is a small rod-shaped organism ($3-8\mu \times 1\mu$) and occurs singly or in pairs: it is straight and rigid and has absolutely square-cut ends. The bacillus is motile but the motility can only be observed under anaërobic conditions in the centre of the microscopical preparations.

The bacillus of malignant œdema differs from the bacillus of quarter ill in the following respects. It forms long chains, which are never met with either in cultures or tissues in the case of the latter bacillus; it is also more slender, more wavy, longer and more motile, than the bacillus of quarter ill.

Spores are rapidly formed in the muscular swellings but may not appear if death occur very soon. The spore is first apparent as an oval refractile spot in the centre or towards the end of the bacillus often giving rise to an appearance like a tennis racquet or clock pendulum. As a rule spores are not found in the fluid which accumulates about the swellings and are never seen in serous exudates: in cultures, both bacilli and spores are formed.

The relatively large size of the bacillus renders the examination of unstained preparations easy.

Staining reactions.—The bacillus of quarter ill stains readily with solutions of the basic aniline dyes containing a mordant. It is gram-positive and retains the stain by Claudius' method.

The spores may be stained in the usual way (p. 146). They do not stain in the cold with aqueous solutions of the aniline dyes.

(a) *Cultures.*—For cultures the most useful stains are carbol-crystal-violet or dilute carbol-fuchsin.

(b) *Smear preparations.*—Films may be prepared from scrapings from the

swellings, by smearing a little of the peritoneal exudate or œdema fluid on a cover-glass, or by rubbing a cover-glass lightly over the surface of the liver of a guinea-pig dead of the disease. These films may be stained with carbol-crystal-violet, Gram's stain or Claudius' stain.

(c) *Sections*.—The swellings should be used for cutting sections and are best stained with Kuhne's carbol-blue or by Gram's method with counterstain.

Note.—The tissues of carcasses dead of symptomatic anthrax rapidly become invaded by the bacillus of malignant œdema, a normal inhabitant of the intestine.

2. Cultural characteristics.

Conditions of growth.—The bacillus of quarter ill is a strict anaërobie and must therefore be cultivated by the methods applicable to anaërobic organisms.

The media should be recently prepared. Ordinary broth is not a good medium and though the addition of glycerin (4 per cent.), glucose (1 per cent.), or sulphate of iron (1 per cent.), etc. has been proposed, such additions are said to offer no advantages (Kitasato). Leclainche and Vallée obtained very good results with recently prepared Martin's broth. A considerable amount of gas is formed in culture (H_2 , CO_2 , CH_4) which has a characteristic odour of butyric acid.

Growth commences at 15° C. the optimum temperature being about 37° C.

For isolating the organism the peritoneal exudate or heart blood or some of the fluid from the swelling should be used for sowing cultures, but it is rather difficult to obtain pure cultures: in the pulp from the swellings the bacillus is almost always associated with other organisms (facultative aërobes, *Vibriion septique*, etc.).

It is necessary also to test the purity of the culture from time to time by microscopical examination (as indicated above, the appearance of long and wavy threads denotes a contamination with the *Vibriion septique*) and by the inoculation of a rabbit and guinea-pig. If only the guinea-pig die the virus is pure and four or five drops of blood from the heart should be sown immediately after death—this affords in any case a certain method of obtaining pure cultures.

Maintenance of virulence.—In the laboratory the virulence of the micro-organism is maintained by passage through guinea-pigs. It should be remembered that infection with the *Bacillus chauvoei* predisposes in a marked degree to infection with the *Vibriion septique* and that after a few passages the animals die of a double infection.

Culture media. Broth.—Recently prepared Martin's broth is better than ordinary broth. After incubating for about 20 hours at 37° C. there is a general cloudiness of the medium and gas is given off in considerable amount. After 2 or 3 days flocculi form which fall to the bottom and the broth gradually becomes clear.

Albuminous media.—The growth is more luxuriant and the virulence is maintained for a longer time than in broth. Serum or serum diluted with two parts of sterile water or meat juice prepared according to the method given when dealing with the *Vibriion septique* should be utilized.

Gelatin. Deep stab cultures.—Small irregularly spherical colonies throwing out lateral offshoots slowly make their appearance along the line of the needle puncture when the medium is incubated at 20° C.: when they begin to become confluent the gelatin is split by the formation of gas bubbles. The culture spreads irregularly and liquefies the medium.

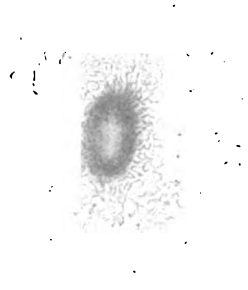

FIG. 263.—The bacillus of quarter ill. Single colony on a glucose-gelatin plate. $\times 60$.

Discrete colonies.—Small whitish spheres with lateral offshoots appear in the depth of the gelatin which subsequently become cloudy and irregular in shape. Gas is formed and the gelatin liquefied.

Agar. Deep stab cultures.—When incubated at 37° C. a cloudy whitish line rapidly appears along the line of the stab, the agar is then broken up by the gas evolved and the gaps are invaded by the culture.

Potato.—No apparent growth.

Milk.—Abundant growth.

White of egg.—White of egg is not sensibly attacked (Jungano and Distaso).

SECTION III.—BIOLOGICAL PROPERTIES.

1. Vitality and virulence.

The bacillus of quarter ill has considerable vitality and since it forms spores is able to resist the ordinary methods employed for the destruction of micro-organisms. In cultures, the spores resist a temperature of 100° C. for several minutes. If some of the exudate in the muscles be dried the spores can only be killed by exposure to moist heat at 110° C. for several hours. Ordinary antiseptic solutions and putrefactive changes have no action on the spores.

The virulence of the organism disappears somewhat rapidly in culture: after being sub-cultivated five or six times in broth it fails to set up a fatal disease in guinea-pigs. Its virulence in culture is readily destroyed by physical agents, *e.g.* an exposure to a temperature of 100° C. for 2 minutes renders it avirulent: serum cultures are more resistant than broth cultures.

In the dried exudate from swellings on the other hand the virulence is as persistent as the vitality; in such an exudate the bacilli after being dried at 35° C. will remain alive and virulent for years. They are able also to resist exposure to high temperatures for several hours (see under Vaccination, *infra*).

In the living tissues the organism retains its properties for a long time: *e.g.* if a frog which has been inoculated but has resisted infection be left for a fortnight or 3 weeks and then be put in the incubator at 25° C. it will suffer from the disease (Arloing).

2. Vaccination.

One attack of symptomatic anthrax confers immunity, and the disease does not recur in the same subject.

1. The injection of the virus into the veins of an ox, a harmless proceeding if properly done, will render the animal immune (Arloing, Cornevin, and Thomas). Cattle can be vaccinated by inoculating 5 or 6 c.c. of a virulent exudate into the jugular vein but on account of inherent difficulties and dangers it has been abandoned as a practical method of vaccination.

(ii) The principle of a method of vaccination devised by Arloing, Cornevin and Thomas is the inoculation of an attenuated virus into the tip of the tail. It has already been mentioned that inoculation in this situation is not a severe method of infection. The attenuated virus is prepared by exposing dried serous exudate from the muscles to the action of heat as follows:

The infected muscles of an ox or sheep dead of quarter ill are finely minced and added to two-thirds their weight of sterile water. The mixture is rubbed up in a mortar and filtered through muslin: the filtrate is poured on to porcelain plates and kept in a dry incubator at 35° C. until completely dry, after which the dried extract is ground up in a pepper mill and then in a mortar until reduced to a very fine powder. In this way a very virulent product is obtained which retains its toxicity for years.

To attenuate the product some of the powder is mixed with twice its weight of sterile water, spread in a thin layer and heated at 100° C. or 105° C. for 5-6 hours. This constitutes the first vaccine and on inoculation leads to no untoward symptoms.

Another portion of the powder is similarly moistened and heated for 5 or 6 hours at 90° or 94° C. only. This is the second vaccine; it is more virulent than the first and is dangerous to inoculate in the first instance.

To vaccinate an animal emulsify in a mortar the contents of a packet of the first vaccine with 10 c.c. of boiled water, stirring meanwhile. Filter the emulsion through a piece of fine linen and inoculate 1 c.c. of the filtrate into the tip of the tail (or into the tip of the ear) after cutting the hair and washing the skin with soap and water. Some days later the immunity is strengthened by inoculating the second vaccine.

The immunity is permanent and accidents are uncommon. If the reaction be over-violent, which is not the case if the inoculation has been properly done, the animal's tail should be cut to remove the focus of infection. The method is now extensively practised in France and Switzerland.

The full virulence of the powder can be restored if necessary by mixing a little lactic acid with it; the acid produces a small necrotic focus and prevents the leucocytes reaching the site of inoculation, and so allows the organism to develop. Alcohol, trauma and certain micro-organic toxins act in the same way. The organism in the powders is never really attenuated: it is true that the virus is modified but only in the sense that its germination is retarded, during which time the inoculated tissues have time to arrange their phagocytic defences. Proof of this view is furnished by the fact that when a little of the powder is sown on artificial media a virulent culture is obtained.

Arloing's powders contain numerous impurities since contaminating micro-organisms are present in very large numbers in the swelling. It is to these latter that the occasional accidents which occur during vaccination are to be attributed. Leclainche and Vallée have described a method by which vaccines containing pure cultures of the organism may be prepared:

The heart blood of a guinea-pig or sheep dead of quarter ill is collected and incubated in sealed capsules for 48 hours at 37° C. The contents are then spread in thin layers in sterile Petri dishes and kept in the incubator at 37° C. until desiccation is complete. The dried blood is powdered and rubbed up with a little sterile water. This paste is spread in thin layers on glass plates and divided into two portions. One is heated in an hot air chamber for 7 hours at a temperature of 102° C. (first vaccine), the other at a temperature of 92° C. (second vaccine). The vaccines are powdered and stored in sterile tubes in the same way as Arloing's.

Note.—Pure vaccines behave like spores of the bacillus in that they are not mixed with toxin and are not fatal to animals in moderate doses, but on the other hand they are efficient for purposes of vaccination which is not the case with pure spores (obtained by heating cultures to 80° C. for 3 hours). If spores be inoculated they are phagocytosed immediately, whereas the physical state of the vaccine when inoculated to a certain extent retards phagocytosis so that the destruction of the spores is delayed until the tissues have had time to elaborate antibodies, which antibodies constitute the immunity of the animal.

(iii) Kitasato and also Kitt state that the inoculation of broth cultures more than a fortnight old does not kill guinea-pigs but confers immunity upon them, and that virulent cultures heated at 80° C. for 30 minutes have similar vaccinating properties whereas if heated at 80° C. for 3 hours these properties are destroyed.

(iv) Leclainche and Vallée have shown that virulent cultures heated at 70° C. for 2 hours do not kill young guinea-pigs but are toxic for adult guinea-pigs. One c.c. of a culture treated in this way confers a lasting immunity on young guinea-pigs: 2 c.c. inoculated into cattle behind the shoulder

gives rise to trifling symptoms and confers a certain degree of immunity ; a second inoculation 7 days later completes the immunization.

On these facts Leclainche and Vallée have based the following method of vaccination.

Pure cultures are sown in Martin's broth and after incubating for 5-8 days are distributed in glass ampoules, which are then sealed and heated in a water bath at 70° C. : this is the first vaccine. The second vaccine is prepared in a similar manner but the ampoules are not heated. This method does away with all need for powdering the vaccines and yields a vaccine of which the dosage is simple.

Vaccination with these pure vaccines is not unattended by danger, and in a later paper Leclainche and Vallée recommend the administration of a dose of immunizing serum as a condition precedent to the inoculation of the pure attenuated virus (*vide infra*).

Note.—*Animals vaccinated against quarter ill with pure vaccines are not immune to malignant œdema* (Leclainche and Vallée).

Roux and Chamberland however had stated that guinea-pigs rendered immune to quarter ill are often immune to the bacillus of malignant œdema, and Dünschmann having obtained an antiserum for quarter ill affirmed that it neutralized fatal doses of the bacillus of malignant œdema. These results were due to the fact that the cultures used by the authors for preparing the immunizing vaccines were impure ; they immunized the animals against both infections at one and the same time.

3. Toxin.

(i) Roux showed that broth cultures sterilized by filtration through porcelain or by heating at 115° C. contain slightly toxic soluble products which on inoculation into animals produce a certain degree of immunity. He was able to immunize guinea-pigs by inoculating them with a total quantity of 40 c.c. of the sterilized cultures administered on three separate occasions at intervals of 2 days.

(ii) Dünschmann obtained a toxin which killed guinea-pigs when given intra-peritoneally in doses of 2 c.c. The bacillus was grown in meat pulp (p. 566) for 7 days ; the fluid was then expressed, filtered through porcelain and inspissated *in vacuo* over sulphuric acid.

(iii) Leclainche and Vallée have shown that the *Bacillus chauvoæi* when grown in Martin's broth produces a powerful toxin the inoculation of which is not followed by any incubation period. The toxicity reaches its maximum about the fifth day of incubation and then diminishes. The decanted fluid is so rapidly fatal to laboratory animals that the bacillus has not time to develop. Three or four drops of such a culture inoculated into the cerebral hemispheres of a guinea-pig lead to a fatal result in a few hours : a dose of 2-5 c.c. inoculated into the ear vein of a rabbit kills the animal in from 5 minutes to 5 hours : 10 c.c. injected into the jugular vein of a horse is fatal in about 6 minutes.

The toxicity diminishes in presence of air : free aëration destroys the toxin in 48 hours. The toxin is not completely destroyed by heating at 115° C., but by heating at 70° or 75° C. its chemiotactic properties which before were negative become positive. A large proportion of the toxin is held back on filtration, but the filtrate is still fatal to experimental animals : guinea-pigs die a few hours after the inoculation of 5 c.c. of the filtrate into the peritoneal cavity, and in smaller doses symptoms of intoxication appear in 7-9 days and the animals die from cachexia.

Eisenberg has confirmed Leclainche and Vallée's experiments. A six-day-old culture in Martin's broth containing normal rabbit serum, after being decanted and centrifuged, killed rabbits in a few minutes when 1 c.c. was inoculated into a vein. This toxin is almost destroyed by heating at 60° C. and is neutralized by the serum of a vaccinated rabbit.

(iv) Grassberger and Schattenfroh find that the toxins produced by different strains of the *Bacillus chauvoei* are not all of the same degree of toxicity, and that in order to prepare a satisfactory toxin it is necessary to select a strain carefully and adapt it to a medium suitable for toxin production. These investigators recommended a lactose-broth containing calcium carbonate as the best medium on which to grow strains which ferment rapidly, and broth containing calcium lactate for strains which do not set up a violent fermentation—since the toxicity is materially diminished by filtration (Leclainche and Vallée) it is necessary to work with decanted cultures. In this way Grassberger and Schattenfroh obtain a toxin which is fatal to guinea-pigs in 2–4 days in doses of 0.01 c.c. inoculated sub-cutaneously (normal toxin). Rabbits, monkeys, dogs, mice, fowls and pigeons are also susceptible to the toxin: inoculation of 40 c.c. beneath the skin of a calf is fatal in 2–6 days: sheep succumb to the inoculation of 2 c.c.

4. Serum therapy.

(i) Kitt was the first to make experiments on the serum therapy of symptomatic anthrax; working with sheep and horses he inoculated the virus first intra-venously and then sub-cutaneously. The serum of these animals, in doses of 5–10 c.c. sub-cutaneously, protects sheep against a virulent inoculation given 3 days to a week later.

(ii) Dünschmann increases the natural immunity of the rabbit by the inoculation of increasing doses of the virus. The serum of the rabbit is then both prophylactic and antitoxic for the guinea-pig, if given either separately, before or at the same time as the virus, or if well mixed with the latter. The serum however has no therapeutic property.

(iii) Arloing immunized an heifer by inoculating it with increasing doses of the virus over a period of 6 months. The animal was then immune to the inoculation into the blood and connective tissues of very large quantities of fluid from a local lesion. Its blood was found to possess prophylactic, therapeutic and antitoxic properties.

Arloing's serum neutralizes double its weight of fresh virulent virus *in vitro*. The mixture may be safely inoculated into sheep.

If inoculated in doses of 10 c.c. into the connective tissues of another part of the body it will, if administered at the same time, protect a sheep weighing 30 kg. against a fatal dose of fresh virus. A similar result is obtained if one-tenth the dose be inoculated intra-venously.

The immunity conferred is of short duration: it is still in evidence on the fourth day but has completely disappeared at the end of a week. If however the inoculation of the serum be followed by an ordinarily fatal dose of fresh virus a much more stable immunity is established.

The inoculation of the mixture of serum and virus produces few symptoms but does not lead to any appreciable degree of immunity. Animals treated with the serum-virus mixture survive the test inoculation rather longer than control animals but always succumb in the end.

The sub-cutaneous inoculation of a powerfully prophylactic serum arrests the extension of a fatal inoculation in sheep, if given within 3 hours of the latter. The same dose is effective if given intra-venously 9 hours after infection, but has no effect after 12 hours.

The properties seem to be preserved intact if the serum be rapidly dried in the air in a thin layer at a temperature of 38° C.

(iv) Leclainche and Vallée obtain an antiserum by hyper-immunizing goats and horses.

(a) **Goats.**—First a virulent culture is inoculated into the veins, and then at intervals of 10 days, 5, 10, and 15 c.c. of a filtered product obtained by crushing

the muscles of infected guinea-pigs in an equal volume of water is inoculated sub-cutaneously.

The serum of the goat after the second sub-cutaneous inoculation protects guinea-pigs against the inoculation of a virulent maceration provided that the test inoculation (0.5 c.c.) be made 1-3 days after that of the serum (1.5 c.c.).

A mixture of the serum with the virus is harmless: serum inoculated at the same time as the test inoculation but into a different part of the body does not protect the animal, and similarly, the serum is without effect if inoculated after the virus.

(b) **Horses.**—Horses are inoculated intra-venously with 10-135 c.c. of cultures in Martin's broth. The serum in doses of 1-5 c.c. immunizes guinea-pigs against the inoculation of a drop of virulent exudate. No immunity is apparent until 12 hours after the inoculation of the serum and is of short duration—at the most a week.

A mixture consisting of 3 c.c. of serum with 5 drops of culture is harmless. Guinea-pigs treated with such a mixture show merely a transitory immunity lasting at the outside 10 days. The serum is without any therapeutic effect on guinea-pigs.

(v) Grassberger and Schattenfroh were unable to immunize guinea-pigs with their toxin (*supra*). Rabbits and cattle on the other hand were easily immunized: calves which had received a total quantity of 60-70 c.c. of toxin in two or three doses no longer reacted to the inoculation of 10 c.c.: in 4-5 months their serum was so antitoxic that 0.0025 c.c. neutralized 1 c.c. of normal toxin.

This serum is prophylactic for guinea-pigs if inoculated before the toxin. If mixed with the toxin the mixture is neutral (guinea-pigs, bovine animals, sheep and rabbits) and induces a permanent immunity against the toxin (rabbits, sheep and cattle, but not guinea-pigs).

Guinea-pigs which have been treated with a prophylactic dose of the antitoxic serum are immune to an inoculation of the *Bacillus chauvæi*. In cattle, prophylactic inoculations of toxin or of the toxin-serum mixture do not always immunize against the experimental disease but appear to yield better results in the case of the naturally contracted infection.

5. Agglutination.

The serums of Leclainche and Vallée agglutinate the bacillus in dilutions of 1 in 30 to 1 in 6,000. The serum of a cow infected with quarter ill agglutinates the bacillus in a dilution of about 1 in 300.

The serum of healthy animals only agglutinates the *Bacillus chauvæi* in dilutions of less than 1 in 12.

The bacillus of malignant œdema is not agglutinated by the serum in dilutions above 1 in 12 and in the same way the anti-malignant-œdema serum has no agglutinating action on the bacillus of quarter ill: both serums have a strictly specific action (Leclainche and Vallée).

CHAPTER XXXVIII.

BACILLUS MALIGNI ŒDEMATIS.

Introduction.

Section I.—Experimental inoculation, p. 561.

1. Susceptible animals, p. 561.
2. Methods of infection, p. 562.
3. Symptoms and lesions in experimental animals, p. 563.

Section II.—Morphology, p. 563.

1. Microscopical appearance and staining reactions, p. 563.
2. Cultural characteristics, p. 564.

Section III.—Biological properties, p. 565.

1. Vitality and virulence, p. 565.
2. Toxin, p. 565.
3. Vaccination, p. 567.
4. Serum therapy, p. 568.
5. Agglutination, p. 568.

THE bacillus of malignant œdema (Fr. *Vibrion septique*) is the oldest known anaërobic pathogenic micro-organism. In 1887 Pasteur determined its morphology and biological properties and described, as "*acute experimental septicæmia*," the disease which follows the introduction of the organism into the sub-cutaneous cellular tissue of laboratory animals. Chauveau and Arloing showed that the bacillus of malignant œdema is the ordinary cause of the rapid gaseous gangrene of man¹ (gangrenous septicæmia). Krannhals attributed "rag-pickers' disease" to this organism. German writers describe the organism under the name "*Malignes Œdem*."

Certain traumatic gangrenes of domestic animals are also caused by the bacillus of malignant œdema.

The bacillus of malignant œdema is very widely distributed outside the body. In the spore form it is found in garden soil, in dirt from the street, in the mud of different waters, etc. It occurs as an harmless saprophyte in the intestine and in the excreta of man and animals. After death the bacillus may pass from the intestine into the blood stream: this infection of the blood stream takes place very rapidly in animals which have died of anthrax.

SECTION I.—EXPERIMENTAL INOCULATION.

1. Susceptible animals.

Most animals are susceptible to infection with the bacillus of malignant œdema and guinea-pigs and mice particularly so: one-millionth of a drop of an infected exudate is sufficient to kill a guinea-pig (Davaine).

¹ The bacillus of malignant œdema is not the only cause of gangrene. In Chap. XXXIX. a number of other anaërobic organisms which may be concerned in gangrenous conditions are described.

Besson has shown that passage through guinea-pigs increases the virulence of the organism. A bacillus is rapidly obtained of such virulence that less than one-hundredth of a drop of a broth culture is fatal to guinea-pigs and rabbits in 8 hours, and one drop is fatal to cats in 12–15 hours.

Rabbits and white rats come next in the scale of susceptibility. Sheep, goats and horses are also very susceptible; the same is true of cats, a species which is often erroneously said to be only slightly susceptible. Asses, small birds, fowls and pigeons are less susceptible, next come dogs and finally oxen.

Sewer rats are almost immune and only succumb to considerable doses of very virulent viruses.

2. Methods of infection.

The bacillus of malignant oedema is a strict anaërobe and only multiplies in the living tissues when introduced deeply beneath the skin or into the muscles or peritoneal cavity. It does not lead to septicæmia when inoculated into the veins and does not infect superficial wounds (Chauveau and Arloing). The disease may be produced experimentally in animals in many ways.

(i) **By inoculation of a culture or infected exudate.**—Sub-cutaneous inoculation is a very severe method of infection. Doses of less than 0·01 c.c. will rapidly kill susceptible animals.

(ii) **By inoculation of the spores alone. Ancillary organisms.**—Besson has shown that when the spores of the bacillus alone are inoculated into the sub-cutaneous tissues of guinea-pigs and rabbits even in considerable doses (4 or 5 million in the case of the guinea-pig, 14 million in the case of the rabbit), they do not germinate but are rapidly phagocyted, and the animal shows no lesion other than a small hard nodule at the site of inoculation which disappears in a few days.

Pure spores are easily obtained by destroying the toxin in broth cultures by heat. Aspirate a few drops of a spore-bearing broth culture into a small glass tube, seal it at both ends and keep it in a water bath at 80° C. for 3 hours. If the heated culture be inoculated even in large quantities the animal suffers no ill-effects but if it be sown in a fresh tube of broth a very virulent culture is obtained. An even more simple method consists in using cultures which have been in the warm incubator (37° C.) for several months; under these conditions the toxin disappears and the spores alone remain.

It is, however, only necessary to add a small quantity of some negatively chemiotactic substance to spores to prevent the phagocytes fulfilling their protective rôle to induce a condition of septicæmia. Thus, if a small drop of lactic acid be mixed with the spores and the mixture be inoculated the animal will die. A similar result is obtained if a small quantity of the toxin of the bacillus, which possesses chemiotactic properties, be added to spores: or if the latter be mechanically protected against the action of the phagocytes—as by enclosing them in a little piece of sterile filter-paper or in a small cube of agar before introducing them beneath the skin of a guinea-pig.

The septicæmia can be still more easily produced by spores free from toxin if they be mixed with some other micro-organism, harmless in itself but the secretions of which are negatively chemiotactic. Many organisms found in soil can be used in this experiment as well as other species *e.g.* the *Micrococcus prodigiosus* and the *Staphylococcus pyogenes aureus*.

In the same way, traumatic injuries leading to death of the tissues (burns, ligatures, etc.) lead to a diminished activity on the part of the phagocytes and so favour the development of the spores.

(iii) **By inoculation of soil containing spores.**—The inoculation of a trace of mud from the street or of garden soil sub-cutaneously beneath the skin of a guinea-pig or rabbit often results in a fatal septicæmia. The development

of the spores which are in the soil is facilitated by the numerous other organisms present.

3. Symptoms and lesions.

The septicæmia of Pasteur runs a similar course in all animals but the duration of the disease varies with the species inoculated.

The symptoms in the guinea-pig which are typical of those seen in other animals are as follows: very soon after the inoculation of a trace of a virulent culture beneath the skin of the thigh or abdomen an œdema forms at the site of inoculation; a few hours later the animal with its coat staring is found crouching in a corner of its cage showing no inclination to move, convulsions soon appear and death supervenes often in less than 12 hours.

When the virulence of the organism is very high, the œdema is negligible and the septicæmia develops very rapidly, death taking place after a very few hours' illness.

Post mortem, there is more or less œdema at the site of inoculation; the muscles in the neighbourhood are bright red and infiltrated with a serous exudate, while the connective tissue is distended with bubbles of fetid gas and crepitates beneath the finger. A variable amount of almost clear serous exudate is present in the peritoneal cavity: the liver is discoloured and the spleen diffuent while the lungs are normal in appearance. A most disagreeable smell emanates from the carcase.

The fluid of the local œdema contains large numbers of bacilli but no leucocytes. The peritoneal exudate examined under the microscope also gives the appearance of a pure culture of the bacillus with numerous filamentous forms: spores are not found in the living animal, but are formed rapidly after death, especially if the carcase be kept in the incubator at a temperature of 35° C.

The bacillus of malignant œdema is very seldom found in the blood of animals during life, but it enters the blood stream soon after death. If the body be left in the incubator (35° C.) for a few hours and blood films be then made a large number of bacilli will be found.



FIG. 264.—The bacillus of malignant œdema. Smear preparation from the surface of the liver of a guinea-pig. Carbol-blue. (Oc. II, obj. 1/3th, Reich.)

SECTION II.—MORPHOLOGY.

1. Microscopical appearance and staining reactions.

The bacillus of malignant œdema is a rod-shaped organism measuring 3–15 μ \times 0.6–1 μ , more slender than the anthrax bacillus, and occurring singly or in chains. Chains are particularly numerous in the blood of carcases kept for a few hours at 37° C.: under these conditions the bacilli form long filaments (40 μ) made up of unequal segments. The rods though sometimes straight are more often curved and wavy; their ends are clean cut and very slightly rounded at the angles, in contrast to the ends of the anthrax bacillus which are sinuous but form a right angle with the lateral surface.

The bacillus is motile, but only under anaërobic conditions, so that the centre and not the edge of the preparation should be examined. The vibrios move with a slow undulating creeping movement due to flagella arranged laterally on the organism.

Spores are rapidly formed in the bodies of dead animals and in cultures. The spore appears as a brilliant refractile oval point which causes a swelling in the centre or towards the end, but very rarely exactly at the end of the bacillus.

There appear to be several varieties of the bacillus distinguished by differences of motility, degrees of virulence and the rapidity with which they liquefy serum. Great uncertainty, however, still exists on this point and it is reasonable to suppose that the so-called different varieties are merely modified forms of one and the same organism.

Staining reactions.—The bacillus of malignant œdema is easily stained by the basic aniline dyes. It is gram-positive but the reaction is inconstant



FIG. 265.—The bacillus of malignant œdema. Film from a 3 days' growth on agar. Dilute carbol-fuchsin. (Oc. IV, obj. $\frac{1}{3}$ th, Reich.)

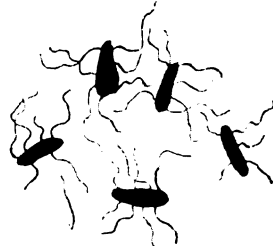

FIG. 266.—The bacillus of malignant œdema. Flagella. $\times 1200$.

unless certain precautions be observed. The best dye is carbol-gentian-violet, and it should be left on the film for 5 minutes before being replaced by the iodine solution. The bacillus stains well by Claudius' method.

Spores and flagella may be stained by the methods described in Chap. IX.

2. Cultural characteristics.

Conditions of growth.—The bacillus of malignant œdema is a strict anaërobie and can only be grown by the methods described in Chap. VI.

The bacillus of malignant œdema is one of the least strictly anaërobic of all the anaërobic organisms and grows quite well in media from which the air has been only partially removed. Rosenthal has been able to adapt it to aërobic conditions.

Growth does not take place below 15° C. The optimum temperature is about 37° C. Very satisfactory cultures can be obtained by incubating at 41° C. (Besson).

Culture media. Broth.—A well marked cloudiness appears after incubating at 37° C. for 12 or 20 hours. Indol and evil smelling gases (CO₂, H₂, hydrocarbons and volatile sulphur compounds) are produced in considerable amount. The broth soon clears, the growth precipitating to the bottom of the tube. As long as the broth is cloudy it contains numerous bacilli which form spores after about 20–24 hours. In the deposit spores and granular disintegrated bacilli only are to be found.

Albuminous media.—The culture is similar to that in broth but more abundant. Broth containing blood or ascitic fluid, Martin's broth, serum either pure or diluted with an equal volume of water or broth, and meat juice sterilized by filtration through a Chamberland bougie all give very abundant growths.

The following medium appears to give the best cultivations (Besson).—To 500 grams of finely minced lean meat add 500 c.c. of distilled water and a large pinch

of salt. Leave the mixture in the ice-chest for 12 or 20 hours. Decant the liquid and squeeze the residue in a meat press. Add normal soda solution until the reaction of the fluid is feebly alkaline then heat to 115° C. for 5 minutes. Filter through Chardin paper and sterilize the dark brown filtrate at 112° C. for 20 minutes. A slight coagulum forms during sterilization but dissolves during the growth of the organism.

Gelatin. *Deep stab culture.*—At 20° C. growth begins after incubating about 48 hours. Small cloudy spheres appear along the line of the stab and these rapidly become confluent forming a long, whitish streak. Bubbles of gas then appear which split the gelatin and the culture spreads irregularly along these fissures. Liquefaction rapidly follows and involves the whole of the medium.

Single colonies.—On the second or third day small cloudy whitish spots with ill-defined margins appear in the depth of the medium. The medium liquefies around them and bubbles of gas are formed.

Agar. *Deep stab culture.*—Growth in the form of a cloudy whitish streak along the line of the stab very quickly appears on incubating at 37° C. The agar is soon split by bubbles of gas and the culture spreads along the fissures.

Potato.—No apparent growth.

Coagulated serum.—The bacillus grows and liquefies the serum. Cooked white of egg is also digested by the bacillus.

SECTION III.—BIOLOGICAL PROPERTIES.

1. Vitality and virulence.

Vitality.—Bacilli which are not in the spore condition are soon killed by exposure to air or by heating for a few moments at 60° C.

Spores are only formed in the complete absence of air but once formed they are highly resistant to the action of oxygen. Ordinary antiseptic solutions are almost without action upon them (Chauveau and Arloing). In the moist state they resist temperatures of 80° C. for several hours and 90° C. for more than 30 minutes (Besson). They are only killed by moist heat above 100° C. when contained in dried albuminous material. According to Sanfelice they are not affected by exposure to sunlight for 50 hours nor by desiccation extending over several months.

Virulence.—The virulence of the organism is preserved by the spore: this virulence is maintained indefinitely in cultures, but for purposes of inoculation it is always necessary to make a new sub-culture, since the spores alone in ordinary doses are harmless and the toxin is weakened by keeping (*infra*). If this precaution be not observed the organism may be erroneously thought to have become attenuated.

All strains of the bacillus are not equally virulent: some are non-virulent even for guinea-pigs (*vide ante*), but as has already been pointed out these variations are not stable, for the virulence of a slightly virulent bacillus may be easily raised by passage through guinea-pigs.

Leclainche and Vallée have shown that the method of attenuation by heat devised by Arloing, Cornevin and Thomas for the bacillus of quarter ill (Chap. XXXVII.), is equally applicable to this bacillus. Heat the blood of an animal dead of malignant œdema in sealed ampoules at 37° C. for 5 days and treat the contents of the ampoules by Arloing's method (p. 556). The resulting powder constitutes an attenuated virus with which animals may be immunized against the disease.

2. Toxin.

(i) As early as 1887 Roux and Chamberland studied the toxin which the bacillus produces in cultures and in the living organism.

After inoculation the vibrio multiplies and rapidly invades all the tissues of the body: it is not therefore to be expected that its toxin will be as powerful as that of micro-organisms which like the tetanus bacillus and the diphtheria bacillus only grow at the site of inoculation. While the toxins of these latter organisms are fatal to small laboratory animals in almost infinitesimal doses, filtered cultures of the bacillus of malignant œdema have to be inoculated in doses of several c.c. to produce a similar result.

Roux and Chamberland by filtering through a porcelain bougie an emulsion made with the muscles of guinea-pigs and rabbits which had died of the disease obtained a liquid which proved fatal when inoculated in quantities of 40 c.c. into the peritoneal cavity of a guinea-pig.

(ii) Besson re-investigated the toxin of the bacillus. Cultures and the exudate from animals which had just died of the acute experimental disease were used after being filtered through a Chamberland bougie.

(a) For cultures, it was necessary to select a medium favouring the formation of the largest quantity possible of toxin. Cultures in ordinary broth were not suitable. Better results were obtained with cultures grown on meat pulp.

Besson's method for the preparation of the toxin.—To 500 grams of minced beef in a flask of 1500 c.c. capacity and plugged with wool add a few c.c. of a 1 per cent. solution of soda and heat at 115° C. in the autoclave for 20 minutes. When cool, sow the medium with a little of the exudate obtained from a guinea-pig which has died as the result of the inoculation of a bacillus the virulence of which has been increased by passage through guinea-pigs. For the cotton-wool plug substitute a sterile india-rubber cork carrying two tubes, one of which dips into the contents of the flask and outside is bent at an acute angle and terminates in a fine point: this tube serves for the decantation of the toxin after incubation. The other tube only passes just through the cork and outside is bent at a right angle, plugged with wool, and constricted near the end. Attach the latter tube to the water pump and when a vacuum is created seal the tube in the blow-pipe at the constricted part. Incubate the flask at 37° C. After incubating about 20 hours numerous bubbles of gas burst on the surface of the doughy mixture in the flask, the meat has a characteristic bright pink colour and tends to divide into two layers, i.e. the culture consists of a semi-solid irregular broken mass bathed in a reddish turbid fluid. A considerable amount of gas is formed during incubation and if allowed to accumulate will check the growth of the organism and prevent the formation of toxin; it is therefore advisable after about 48 hours to break off the sealed end of the tube, when the gas, which has a most offensive odour, will escape under considerable pressure. The tube need not be sealed again because the amount of gas formed is sufficient to keep the culture under anaërobic conditions.

Experience has shown that the toxin content is greatest about the sixth day of incubation and afterwards rapidly diminishes, so that the flask must then be taken out of the incubator. Decant the liquid and press the solid portion in the meat press. Add the juice obtained from the latter to the liquid and filter the mixture through a Chamberland bougie.

This toxin is more active than Roux and Chamberland's. A dose of 3–5 c.c. injected into the peritoneal cavities of guinea-pigs weighing 450–600 grams produces symptoms similar to those seen in the last stages of the septicæmic form of the disease but from which the animals rapidly recover. Similar or larger doses inoculated into the sub-cutaneous tissues have much less effect on the general condition and hardly any effect at all on the temperature, but give rise to a local œdema or slough.

Intra-peritoneal inoculation of doses of 5–10 c.c. is rapidly fatal to guinea-pigs weighing 300–400 grams and the symptoms are not preceded by any incubation period.

Guinea-pigs and rabbits inoculated frequently with small doses of toxin suffer as a rule from a chronic intoxication and ultimately die.

Post mortem examination of animals dying as the result of the intra-peritoneal inoculation of toxin shows the intestines and peritoneum to be congested and the peritoneal cavity to contain a little sterile exudate.

The addition of iodine solution seems to modify the properties of the toxin very slightly. Heat, on the other hand, has a distinct effect: a temperature of 80° or 100° C. markedly diminishes the toxic property of cultures.

If the toxin be kept for some time at 35° C. in diffused daylight it soon loses its properties, but if stored in a closed vessel away from air and light at room temperature it does not deteriorate.

(b) The product obtained by filtering the œdematous fluid of animals dead of the disease is much less toxic than the toxin prepared as above. Doses of 2–10 c.c. of the filtered exudate inoculated into the peritoneal cavities of guinea-pigs weighing 280–350 grams do the animals no harm. In guinea-pigs weighing 300 grams doses of 15–20 c.c. produce more or less severe symptoms but the animals always recover. Death only occurs when doses of 30–40 c.c. are given intra-peritoneally.

Chemiotactic properties.—The toxin of the bacillus of malignant œdema has negative chemiotactic properties (Besson).

Aspirate the toxin into capillary tubes 2–3 cm. long and seal one end. Introduce the tubes beneath the skin of guinea-pigs and rabbits through very small incisions and after 8, 10 and 20 hours remove them and examine their contents. Although control tubes containing a little of the broth used for the cultures and inserted beneath the skin at the same time now contain a turbid liquid very rich in leucocytes the contents of the tubes containing the toxin are clear and no leucocytes can be detected on microscopical examination. It is only after 24 or 30 hours that the latter contain leucocytes: this may be due either to the fact that the properties of the toxin have undergone modification from their prolonged contact with the living tissues or to the fact that the toxin has diffused out and been replaced by lymph.

Heating at 85° C. for 2 or 3 hours fundamentally alters the chemiotactic properties of the toxin: previously negative they are now positive and tubes inserted beneath the skin of guinea-pigs and rabbits quickly fill with leucocytes.

(iii) Leclainche and Morel obtained an active toxin by growing the organism in Martin's broth: the culture was decanted not filtered, because the filter retained a portion of the toxin. The product obtained killed rabbits in doses of 5 c.c. when inoculated intra-venously. Intra-cerebrally 5–6 drops produced a fatal result.

3. Vaccination.

Roux and Chamberland succeeded in vaccinating guinea-pigs by repeatedly inoculating large doses of broth cultures heated at 110° C. for 10 minutes into the peritoneal cavity. After inoculating a total quantity of 120 c.c. of the heated culture on three separate occasions at intervals of 3 days the animals were found to be immune.

Immunization by the injection of increasing doses of filtered meat cultures is very difficult (Besson). Most of the animals submitted to the treatment died of a chronic cachexia.

Roux and Chamberland immunized guinea-pigs by inoculating them on seven or eight occasions with 1 c.c. of œdema fluid which had been filtered through a porcelain bougie.

Besson has succeeded in immunizing rabbits by repeatedly inoculating them in the cellular tissue of the ear with the unfiltered exudate. On the first occasion $\frac{1}{10}$ – $\frac{1}{2}$ th of a drop is inoculated into the extreme tip of the ear: a sharp reaction occurs and the inoculated part has an erysipelatous appear-

ance. The inoculations are repeated every week or 10 days, gradually increasing the doses inoculated to $\frac{1}{4}$, $\frac{1}{2}$ and 1 drop, and inoculating each time a little nearer the base of the ear. After 5 or 7 weeks the animal may be inoculated with 1 drop of virulent exudate beneath the skin of the abdominal wall, and the degree of immunity is increased by successive inoculations into the cellular tissue of the trunk. When large doses are being administered it is not uncommon to find that an abscess forms in which phagocytosis is very active: these abscesses resolve. The immunity so acquired is permanent and may be transmitted from the mother to the offspring.

It should be mentioned that Leclainche and Vallée have succeeded in immunizing guinea-pigs by Arloing's vaccination method (*supra*).

4. Serum therapy.

Leclainche obtained a very powerful serum by inoculating asses, animals which are only slightly susceptible to the disease, intra-venously and then intra-muscularly (into several muscles) first with the exudate and afterwards with cultures grown in Martin's broth.

This serum is powerfully antitoxic and neutralizes the toxin of the bacillus.

A mixture of 2 c.c. of the serum with 5 drops of an exudate is harmless to guinea-pigs. The animals show no degree of immunity as a result, and die as quickly as the controls when tested by inoculation. The serum is without action on the virus of quarter ill.

5. Agglutination.

Leclainche's serum agglutinates young cultures grown in Martin's broth in a few minutes. This agglutination occurs in dilutions of 1 in 30 to 1 in 3,000 and is more marked under aërobic than under anaërobic conditions. The bacillus of quarter ill is not agglutinated by a malignant oedema serum.

CHAPTER XXXIX.

CERTAIN ANAËROBIC MICRO-ORGANISMS FOUND IN GANGRENOUS SUPPURATIONS.

- I.—*Bacillus perfringens*, p. 569.
Ghon and Sachs' bacillus, p. 571.
- II.—*Bacillus pseudo-œdema*, p. 571.
- III.—*Bacillus ramosus*, p. 571.
- IV.—*Bacillus serpens*, p. 572.
- V.—*Bacillus thetoides*, p. 572.
- VI.—*Bacillus fragilis*, p. 573.
- VII.—*Bacillus fusiformis*, p. 574.
- VIII.—*Spirillum nigrum*, p. 577.
- IX.—*Staphylococcus parvulus*, p. 578.
- X.—*Micrococcus fœtidus*, p. 578.
- XI.—*Bacillus aërobicus sepsis*, p. 578.

THE study of the pathogenic anaërobic micro-organisms has until recently been much neglected, but thanks to the work of Veillon and his pupils, interest in this branch of bacteriology has now been aroused. A rich bacterial flora has been found in gangrene and in gangrenous suppurations and it is desirable that the principal species isolated should be shortly described here.

I. BACILLUS PERFRINGENS.

THE *Bacillus perfringens* is an anaërobic organism discovered in 1898 by Veillon and Zuber in conditions of gangrene. Certain organisms which were previously known and to which various names were given are now believed to be identical with the *Bacillus perfringens*: the following must be regarded as coming within this category:—

1. The bacillus discovered by Achalme in 1891 in acute articular rheumatism;
2. The *Bacillus aërogenes capsulatus* of Welch, which was found in the tissues of a dead body;
3. The *Bacillus phlegmonis emphysematosæ* isolated by Fränkel from a phlegmonous inflammation.

The *Bacillus perfringens* is exceedingly wide-spread. Achalme found it in the blood of persons suffering from rheumatism and in the myocardium of two individuals who had died of acute articular rheumatism; Veillon and Zuber in gangrenous suppurations (appendicitis, etc.); Guyon, Albarran, Jungano, in urinary abscesses; Fränkel in an inflammatory swelling; Guillemot in a case of gaseous gangrene; Jungano in cases of chronic urethritis; Chaillous and Benedetti in ocular infections.

It is a normal inhabitant of the alimentary canal of man and many of the lower animals and it possibly plays a part in the aetiology of certain forms of diarrhoea (Tissier, Metchnikoff). It is also present in bodies undergoing decomposition.

1. Experimental inoculation.

Guinea-pigs are the animals most susceptible to experimental inoculation. Death follows sub-cutaneous inoculation in 24–48 hours with lesions similar to those of malignant oedema: at the site of inoculation the skin is stripped up by a gas-containing abscess: the internal organs are crowded with micro-organisms.

Rabbits are not so susceptible. Sub-cutaneous inoculation is followed by the formation of a large gas-containing abscess which generally resolves: if death occur it does not usually take place until about a week after the inoculation. Inoculation into the veins even is not always fatal.

2. Morphology.

The *Bacillus perfringens* is a large, straight, non-motile bacillus of variable length and a little larger than the anthrax bacillus. The ends are square cut or slightly rounded. In the tissues the bacilli are as a rule shorter than in cultures, are often surrounded by a very distinct capsule, and are occasionally (e.g. in the peritoneal exudate) arranged in somewhat long chains. In cultures on liquid media the bacilli are generally long and slender: in old cultures involution forms occur—deformed bacilli with rounded ends and staining irregularly.



FIG. 267.—*Bacillus perfringens*. Film from a glucose-broth culture. Carbol-thionin. $\times 1000$.

Spore formation does not occur in sugar-containing media but in media containing no sugar and especially on cooked white of egg in normal saline solution an oval spore is formed towards one end which stains with difficulty (Muscatello).

Staining reactions.—The *Bacillus perfringens* stains easily with the basic aniline dyes and is gram-positive.

3. Cultural characteristics.

The *Bacillus perfringens* is a strictly anaerobic organism and grows best on media containing glucose. At 37° C. and even at ordinary temperatures it grows very rapidly. It decomposes powerfully sugars and proteins giving off a considerable quantity of gas which has an odour of butyric acid. It produces no indol. According to Achalme it reduces nitrates to nitrites.

The vitality of the bacillus is rather low and it should be frequently sub-cultivated.

Rosenthal claims to have been able to adapt the *Bacillus perfringens* to aerobic conditions. Rosenthal distinguishes two varieties of the bacillus, the common variety which grows with a fetid odour, and a variety which does not give rise to this disagreeable smell and is less active in attacking culture media: the latter variety is said to correspond to Achalme's rheumatism bacillus.

Broth.—The medium soon becomes cloudy and later the growth precipitates in the form of whitish flakes leaving the broth clear.

Gelatin.—In gelatin containing no sugar, some strains distinctly liquefy the medium while with others liquefaction only takes place slowly and to a slight degree.

Discrete colonies are round with irregular margins, and are slightly granular : the medium is split by bubbles of gas and liquefaction then occurs.

Agar.—According to Jungano and Distaso, isolated colonies on agar are characteristic : they are small, lenticular or heart-shaped, with regular sharp-cut edges, and under the microscope are somewhat granular. Numerous bubbles of gas are rapidly formed.

Milk.—Coagulation takes place in 24 hours and is accompanied by a smell of butyric acid.

White of egg.—White of egg is attacked very slowly and a black pigment is formed at the bottom of the tube.

4. Toxin.

Cultures sterilized by filtration or by chloroform have no action on guinea-pigs or rabbits (Jungano).

Korentchevsky obtained a toxin from a bacillus isolated from a dog the virulence of which had been increased by passage through three rabbits. This toxin was fatal to rabbits in quantities of 1 c.c. per kilogram of body weight.

GHON AND SACHS' BACILLUS.

Ghon and Sachs found a bacillus resembling the *Bacillus perfringens* in the liver of a person affected with gaseous gangrene. This bacillus, however, was more slender than the *B. perfringens* and was sometimes motile and curved : the spore was situated in the middle and took Gram's stain when young. The organism is very slightly pathogenic for laboratory animals (mice, guinea-pigs and rabbits), in which it produces a temporary swelling.

II. BACILLUS PSEUDO-ŒDEMA.

The *Bacillus pseudo-œdema* was first isolated by Liborius from garden soil and afterwards by Sanfelice from soil and the excreta of animals. The *Proteus hominis capsulatus* obtained by Bordoni Uffreduzzi from a case of human septicæmia is apparently the same organism.

Experimental inoculation.—The *B. pseudo-œdema* is pathogenic for rabbits, guinea-pigs and mice ; if a considerable quantity of culture be inoculated the animals suffer from lesions similar to those of malignant œdema.

Morphology.—The bacillus is stouter than the bacillus of malignant œdema and sometimes forms filaments. It has a very distinct capsule, and generally shows two oval terminal spores. It stains easily with the aniline dyes and irregularly with Gram's stain.

Cultural characteristics.—The *Bacillus pseudo-œdema* is a strict anaërobe and grows abundantly on the ordinary culture media producing a considerable quantity of gas and giving off a fetid odour. It liquefies gelatin.

III. BACILLUS RAMOSUS.

This bacillus was found by Veillon and Zuber in a number of instances in pus from gangrenous inflammations (otitis, appendicitis, etc.), and by Monnier in dental caries. It is a normal inhabitant of the intestine. The bacillus described by Lotti in a case of appendicitis, Grigoroff's "A" bacillus (appendicitis), and the *Bacillus pœciloides* of Roger and Garnier are, according to Jungano and Distaso, the same organism.

Experimental inoculation.—The *Bacillus ramosus* is pathogenic for rabbits, guinea-pigs and mice ; these animals die in 6–8 days after being inoculated sub-cutaneously with cultures.

Morphology.—The *Bacillus ramosus* is a small slender non-motile bacillus, a little larger than the bacillus of mouse septicaemia, occurring singly, or in pairs parallel to one another or at an acute angle. In cultures it is often longer, and then has somewhat the appearance of the diphtheria bacillus. Occasionally the bacilli are arranged end to end forming long filamentous chains; and branching forms have been described. It does not appear to produce spores.



FIG. 268.—*Bacillus ramosus*
(Veillon and Zuber).

Staining reactions.—The *Bacillus ramosus* stains easily with carbol-violet and is gram-positive.

Cultural characteristics.—The *Bacillus ramosus* is a strict anaërobe; it grows on the ordinary media and best between 33° C. and 39° C. Cultures grow slowly and are scanty and have a fetid odour. The bacillus produces a little gas and retains its vitality for a long time.

Broth.—Uniform turbidity.

Gelatin.—No growth.

Agar.—Isolated colonies are small, rounded or cuneiform, with regular edges.

Milk.—Milk is coagulated; the casein is not attacked.

IV. BACILLUS SERPENS.

The *Bacillus serpens* was found by Veillon and Zuber in pus from a mastoid abscess, by Rist and Guillemot in gangrene of the lung, and by other observers in similar morbid processes.

Experimental inoculation.—The *Bacillus serpens* is pathogenic for rabbits, guinea-pigs and mice. In guinea-pigs, sub-cutaneous inoculation is followed by the formation of a fetid abscess and death takes place in about a week.

Morphology.—The *Bacillus serpens* occurs as large straight rods with rounded ends. In cultures the bacilli are often arranged in pairs end to end, are motile and move with a sort of an undulatory movement.

Staining reactions.—The *Bacillus serpens* stains easily with the basic aniline dyes containing a mordant. It is gram-negative.

Cultural characteristics.—The *Bacillus serpens* grows anaerobically on all the ordinary media and at the temperature of the laboratory. Cultures have a fetid odour and give off a little gas.

Broth.—Broth soon becomes cloudy but the growth subsequently precipitates and the medium slowly clears.

Gelatin.—Small round greyish colonies appear about the fourth or fifth day. The medium is slowly liquefied.

Agar.—After about 24 hours, isolated colonies appear as small, grey, round, granular points, translucent at first but opaque later.

V. BACILLUS THETOIDES vel FUNDULIFORMIS.

This organism was found by Hallé in the vagina and in the pus in cases of inflammation of Bartholin's glands, and by Rist and Guillemot in pulmonary gangrene, mastoid abscesses, etc.

The *Bacillus thetoides* is described by Veillon and Zuber as *B. funduliformis*.

Experimental inoculation.—Guinea-pigs appear to be the only laboratory animals susceptible to infection with the bacillus.

Morphology.—The *Bacillus thetoides* is a pleomorphic organism. In the tissues, it generally occurs as a slender fairly straight rod: in cultures, rods, filaments, and forms with terminal enlargements are found. It is non-motile.

Staining reactions.—The *Bacillus thetoides* stains badly with the basic aniline dyes: portions of the organism remain unstained and particularly the ends so that the bacillus not uncommonly resembles the Greek letter θ . It is gram-negative.

Cultural characteristics.—The *Bacillus thetoides* is a strictly anaërobic organism and does not grow at temperatures below 22° C.—25° C. It produces no gas.

It grows on agar at 22° C. but not on gelatin. Agar appears to be the best medium: on this medium the growth of the organism takes the form of small rounded homogeneous pale yellow almost punctiform colonies with regular margins.



FIG. 269.—*Bacillus thetoides*. Film from an agar culture. Carbol-fuchsin.

VI. BACILLUS FRAGILIS.

This bacillus was isolated by Zuber and Veillon from some pus from a case of appendicitis and it has since been frequently found in pus from gangrenous conditions of the appendix (Veillon and Zuber, Grigoroff), in peri-urethral infections (Cottet, Jungano), in pulmonary gangrene (Guillemot), in dental caries (Monnier), etc.

Experimental inoculation.—The *Bacillus fragilis* is not very pathogenic for laboratory animals.

A gangrenous inflammation generally follows the sub-cutaneous inoculation of the bacillus into a guinea-pig and the animal may die from 20–30 days later. The inoculation of large doses of cultures into the veins of rabbits leads to death from cachexia; there is no multiplication of the organism.

Morphology.—The *Bacillus fragilis* is a small short non-motile organism with rounded ends sometimes having the appearance of a diplococcus: it is generally longer in culture than in the tissues. It does not form spores.

Staining reactions.—The *Bacillus fragilis* stains with some difficulty with the basic aniline dyes containing a mordant, so that in stained films it frequently has a granular appearance due to parts of the organism not having taken the stain. It is gram-negative.

Cultural characteristics.—The *Bacillus fragilis* is a strict anaërobe and grows slowly and feebly with a disagreeable smell and the production of a small quantity of gas. Cultures have very little vitality and die if kept in the incubator for 6–8 days.

Broth.—The medium becomes cloudy about the third day.

Gelatin.—Small punctiform colonies appear in about 10 days to a fortnight.



FIG. 270.—*Bacillus fragilis*. Film from a broth culture. Carbol-fuchsin. $\times 1000$.

Agar.—Very small translucent colonies often having a muriform appearance are visible about the third or fourth day (Jungano and Distaso).

VII. BACILLUS FUSIFORMIS.

1. Introduction.

The *Bacillus fusiformis* was discovered by Vincent in cases of **Hospital gangrene**.

The bacillus is constantly found in the lesions of hospital gangrene being present in very large numbers in the pseudo-membranous tissue covering the surface of the wounds. It does not invade the tissues and is never found in the blood or lymphatic glands.

In the lesions the *Bacillus fusiformis* may be found in pure culture or associated with other organisms: sometimes micrococci or bacilli are found (especially on the surface of the lesions) but the organism most commonly associated with the bacillus is a spirillum (40 times out of 47 cases examined) which is very delicate and difficult to stain (*vide infra*). Other organisms which may be found are: *staphylococci*, *streptococci*, *proteus vulgaris*, *bacillus pyocyaneus*, *bacillus coli*, *pneumobacillus*.

The bacillus has also been found by the same observer in cases of sore throat (Vincent's angina), in diphtheroid stomatitis (accompanied by various organisms) and in membranous stomatitis associated with a spirillum.¹ Vincent's observations have been confirmed by Bertheim, Raoult and Thiry, Abel and others.

The bacilli described by Veillon and Zuber and by Grigoroff and Perrone in appendicitis, by Bernheim and Popischill in gangrenous laryngitis, by Silberschmidt in fetid bronchitis, by Freimuth and Petruschy, Passini, Leiner and others in noma, as well as the organism described by Zeitz as the *Bacillus hastilis* and found by him in the crypts of the tonsil, are all identical with the *Bacillus fusiformis*.

The *Bacillus fusiformis* has been shown to be present in the mouths of healthy persons and in the tartar on the teeth by Muhlens and others.

2. Experimental inoculation.

A. Hospital gangrene. Man.—Direct inoculation from man to man attempted long ago by Willaume and others, and more recently by Vincent on himself and on a number of Arabs has always failed to set up the lesions of hospital gangrene.

Animals.—1. In *guinea-pigs*, *rabbits* and *white rats* artificial wounds covered with fresh pieces of membrane have healed rapidly without any of the features of hospital gangrene. The inoculation of emulsions of false membranes either beneath the skin or into the peritoneum, blood, or muscles leads to nothing more serious than an abscess due to the other organisms present. Inoculation fails even after cutting the sciatic nerve, tying the femoral artery or crushing the limb.

Coyon, however, succeeded in producing an infection in a guinea-pig. He lacerated the muscles of the thigh of the animal and made a deep ragged opening into which he introduced the pseudo-membrane from a case of hospital gangrene. The wound was sutured and the skin painted over with collodion. A funnel-shaped wound developed covered with a tough membrane in which the *Bacillus fusiformis* was present in enormous numbers.

Healthy animals even when fasting are not susceptible.

¹ This spirillum will be referred to later in connexion with the spirochæte of syphilis which it resembles closely.

2. By operating upon animals whose resistance had been lowered by a micro-organic disease, or by mixing the bacillus in the emulsion with other organisms Vincent succeeded in producing hospital gangrene.

A *tuberculous rabbit* was inoculated sub-cutaneously in the flank with 1 c.c. of an emulsion of gangrenous material: at first a small abscess formed, and later an ulcer appeared covered with a membrane containing the bacillus.

Hospital gangrene has been produced in rabbits by mixing the virus with a few drops of a culture of *streptococci*, *staphylococci*, *bacillus coli*, bacillus of Friedländer or *bacillus pyocyaneus*. In these lesions the ancillary organism always tends to disappear leaving the specific organism in practically pure culture. Most frequently the ancillary organisms occur on the surface of the lesions while the *Bacillus fusiformis* predominates in the deeper layers of the exudate. Inoculations from animal to animal do not succeed.

B. Vincent's angina.—Inoculation of the false membranes from cases of Vincent's angina beneath the skin or into the muscles of laboratory animals produces abscesses and ulcerating foci of necrosis in which the *Bacillus fusiformis* together with many other organisms is found. The inoculation at the same time of a 1 in 5 solution of lactic acid stimulates the formation of the lesions and the growth of the bacillus.

The inoculation of impure cultures obtained by sowing pieces of the false membranes in Martin's broth gives rise to similar lesions.

C. Pure cultures.—The inoculation of pure cultures of the bacillus from whatever source derived is generally followed by negative results; the pathogenic power of different strains varies and in any case rapidly disappears in sub-cultures (Ellermann).

Muhlen, and Tunnicliffe have invariably had negative results: the former inoculated pure cultures (5th and 7th generations) intra-venously, intra-peritoneally, and sub-cutaneously into rabbits, guinea-pigs, and mice and only once obtained a small abscess in a rabbit.

Leiner and Repaci investigated some strains which were pathogenic for rabbits and mice. Ellermann produced suppuration but not necrosis.

3. Microscopical appearance and staining reactions.

Microscopical appearance.—The *Bacillus fusiformis* is a long rod-shaped organism measuring $5-10\mu \times 0.6-0.8\mu$ slightly swollen in the middle and pointed at the ends; it is non-motile.

In films prepared from the false membranes of hospital gangrene or Vincent's angina and stained with carbol-fuchsin or one of the carbol-violet stains, numerous bacilli of the type described above will be seen, often straight but sometimes slightly curved or assuming the form of an elongated S. Many of the bacilli are arranged in pairs. The appearance of these organisms recalls to some extent the appearance of the bacillus of malignant oedema, but with this difference, that the ends of the *Bacillus fusiformis* are not square-cut but rounded or tapering which gives them their characteristic fusiform appearance.

The number of the bacilli in a preparation depends upon the severity of the case from which it is derived: if it be a mild case twenty or thirty may be found, but if severe the number is so considerable as to be truly described as a pure culture.



FIG. 271. — *Bacillus fusiformis*. "Vincent's angina." Mixed infection with spirilla. Carbol-thionin.

Numerous other organisms are always found in association with the *Bacillus fusiformis* in these lesions (*vide ante*).

In wounds which have been treated with antiseptics many involution forms are found: vacuolated bacilli with spindle-shaped ends or indented edges, and long forms with constrictions which stain well and swellings which do not take the stain.

Staining reactions.—The *Bacillus fusiformis* is easily stained by the basic aniline dyes and best by carbol-fuchsin or one of the carbol-violet stains. The bacillus is gram-negative.

When stained with methylene blue portions of the organisms do not take the stain: these unstained areas are not round and are obviously not spores, as they do not stain by the methods used for staining spores.

Sections.—Fix the pieces of tissue for cutting sections in a saturated aqueous solution of corrosive sublimate, and harden in increasing strengths of alcohol. Stain in carbol-thionin. Vincent recommends the following technique:

1. Stain for 10 minutes in carbol-thionin.

2. Treat for a few seconds with the following solution:

| | | | | | | | | | |
|-------------------|---|---|---|---|---|---|---|------|-------|
| Absolute alcohol, | - | - | - | - | - | - | - | 200 | c.c. |
| Iodine, | - | - | - | - | - | - | - | 0.01 | gram. |

3. Pour off the iodine solution and treat with absolute alcohol or alcohol tinted with safranin or fluorescin.

4. Clear in aniline oil. Wash in toluene.

5. Mount in balsam.

In sections stained by this method two layers may be made out:

(a) A superficial layer 1–3 mm. thick, stained bluish grey, and composed of a diphtheroid exudate remarkably poor in cellular elements in its superficial part but in its deeper layers packed with bacilli. Below the layer of bacilli a mass of leucocytes will be noticed.

(b) A layer composed of dead tissue from which all trace of structure has disappeared for part of its thickness.

Note. (a) There are certain discrepancies in the different descriptions of the *Bacillus fusiformis*. By the majority of bacteriologists the bacillus is regarded as non-motile (Vincent, Muhlen, Ellermann, Weaver and Tunnicliffe) but Letulle describes it as motile in saliva, and according to Vespremy it is provided with numerous flagella: Plaut moreover describes very numerous, very delicate flagella like a layer of cotton-wool all round the bacillus. Nearly all observers state that the bacillus is gram-negative but Plaut is of a contrary opinion and is supported by Jungano and Distaso.

(b) The variations in the morphology of the *Bacillus fusiformis* have led Ellermann to describe several species (three types) but of this there is no proof. Similarly, there is no reason to suppose that the *Bacillus fusiformis* is merely a cultivation form of a spirochæte as Silberschmidt has suggested.

4. Cultural characteristics.

Vincent had always failed no matter what media he used to obtain pure cultures of the *Bacillus fusiformis* from cases of hospital gangrene or Vincent's angina.

If a portion of the exudate on the tonsil were sown on Martin's broth an impure culture was obtained in which the bacillus took the form of elongated, non-motile filaments.

More recently however several observers utilizing Veillon's technique have obtained pure cultures of the bacillus. It is a strictly anaerobic organism, grows only at 37° C. and in media to which serous fluids have been added: sugar appears to favour its growth. Eichmeyer lays stress on the importance of keeping the material at a constant temperature of 37° C. and of heating the medium to that temperature before sowing. In cultures the bacillus

remains alive for 20–25 days : it produces no gas but gives off a disagreeable smell.

Isolation.—Lewkowicz isolates the bacillus in Veillon's tubes containing glucose agar to which one-third its volume of the peritoneal fluid of a child is added. After incubating at 37° C. for 4 days sub-cultures can be sown in glucose-agar or glucose-broth to both of which it is necessary to add some serous fluid.

Ellermann recommends the following method for the purpose of isolating the bacillus from the mouths of healthy persons :

1. Sow some dental tartar in Cibil's broth and incubate at 37° C. : after 2 days a deposit will have formed consisting of cocci and the *Bacillus fusiformis*.

2. At the same time sow a tube of sloped agar freely with dental tartar ; then sow a tube of broth with the growth obtained (*staphylococci* and *streptococci*).

3. Sterilize the aerobic broth culture, decant the broth and sow it anaerobically with the impure culture in Cibil's broth : the medium is exhausted for the cocci, and the fusiform bacillus grows abundantly in pure culture. After sowing a few sub-cultures anaerobically on serum-agar a pure culture of the *Bacillus fusiformis* is obtained.

Glucose-serum-agar. (a) *Stab culture.*—Deep stab cultures in glucose-serum-agar give rise, after incubating for 3 or 4 days, to a minimal growth consisting of a greyish streak which extends to within 1 cm. of the surface of the agar (Lewkowicz).

(β) *Isolated colonies.* *Veillon's tubes.*—After incubating for 24–48 hours small, delicate, opaque colonies appear, greyish or yellowish-white in colour with a deeper coloured centre : on further incubation (a fortnight or 3 weeks) the colonies may attain a diameter of 2 mm. (Mühlens, Ellermann).

(γ) *Plates.*—When sown *in vacuo* on the surface of glucose-agar containing an albuminous fluid the *Bacillus fusiformis* grows as small grey points, translucent and thin, which may reach a diameter of 1.25 mm. and which show under the microscope a very delicate festooned margin (Lewkowicz).

Broth.—In glucose-broth containing a serous fluid, after incubating for a few days, the bacillus produces a somewhat abundant greyish white deposit, the broth remaining clear (Lewkowicz).

VIII. SPIRILLUM NIGRUM.

The *Spirillum nigrum* was described by Rist in suppurations of the ear.

Guinea-pigs are the most susceptible animals, but the pathogenic properties of the organism for the lower animals are very slight.

Microscopical appearance.—The *Spirillum nigrum* is a small, very slender organism of the shape of a parenthesis or an S ; its ends are rounded and it is marked by a small black point either in the centre or at one of the ends. It is highly motile.

Staining reactions.—The *Spirillum nigrum* stains with considerable difficulty ; the only satisfactory dye is carbol-fuchsin without heat. The spirilla stain bright red and present a granular appearance.

The organism is gram-negative.

Cultural characteristics.—The *Spirillum nigrum* is a strictly anaerobic



FIG. 272.—*Spirillum nigrum*. Film from an agar culture. Carbol-fuchsin. $\times 1000$.

organism and grows on the ordinary media even at the temperature of the laboratory. Cultures remain alive for a long time and give off an odour of rotten eggs.

Colonies on agar and gelatin are characterized by their intense black colour: gelatin is not liquefied.

IX. STAPHYLOCOCCUS PARVULUS.

This organism was isolated by Veillon and Zuber from pus from a case of appendicitis and has since been found in appendicitis, in cases of pulmonary gangrene (Guillemot), in cases of infection of the urinary tract (Cottet, Jungano), and in the mouths of very young children (*Micrococcus gazogenes alcalescens* of Lewkowicz).

The organism is only slightly pathogenic for laboratory animals; it gives rise to an abscess when inoculated sub-cutaneously into rabbits and guinea-pigs (Veillon and Rist).

Microscopical appearance.—The *Staphylococcus parvulus* is a very delicate coccus smaller than the *Staphylococcus pyogenes* and arranged in diplococci or in masses.

Staining reactions.—The *Staphylococcus parvulus* stains feebly with methylene blue; the best stain is carbol-fuchsin. It is gram-negative.

Cultural characteristics.—The coccus grows anaerobically on all media, and at the ordinary temperature but better at 37° C. It produces a little gas. Broth becomes cloudy and a dust-like deposit is formed. Cultures on agar and gelatin are in no way characteristic. Gelatin is not liquefied.

X. MICROCOCCUS FETIDUS.

This organism was found by Veillon in pus from cases of gangrene, by Rist in cases of suppuration of the ear, by Guillemot and Cottet in cases of pulmonary gangrene, by Jeannin in cases of putrid puerperal infection, and by Hallé in the vagina, in pus from Bartholin's glands, etc.

It is pathogenic for rabbits and especially for guinea-pigs which succumb in a few days after sub-cutaneous inoculation.

Microscopical appearance.—The organism occurs as single cocci or as cocci arranged as diplococci, and occasionally it forms small masses. In cultures the diplococci are arranged in very short chains of three or four diplococci.

Staining reactions.—The *Micrococcus fetidus* stains easily with the basic aniline dyes and is gram-positive.

Cultural characteristics.—The *Micrococcus fetidus* grows anaerobically on all the ordinary media between 22° and 37° C.: at 22° C. the growth is poor and small in amount. In artificial culture it produces very fetid smelling gases. In broth it gives rise to an uniform turbidity; isolated colonies on agar are small and round and are not particularly characteristic. Growth on gelatin at 22° C. is slow and scanty; the medium is not liquefied.

XI. BACILLUS AEROBICUS SEPIIS.

Legros has recorded two cases of gaseous gangrene in man which were caused by an aerobic bacillus to which he has given the name *Bacille septique aërobie*. Mauté found the same organism associated with staphylococci and streptococci in a case of puerperal infection and also in a case of appendicitis.

The bacillus is a rod-shaped organism with rounded ends, motile, straight or slightly curved and measuring about $3\mu \times 0.5-1\mu$, and sometimes occurs as short

chains. It forms spores. The bacillus stains with the basic aniline dyes and is gram-positive.

Though principally aërobie it can nevertheless grow under anaërobie conditions: the temperature of growth lies between 18° and 43° C.

Broth cultures give off a most offensive butyric odour.

Gelatin is rapidly liquefied. The bacillus grows exceedingly well on agar and potato. It does not produce indol, and coagulates milk in fine granular flakes without altering the reaction of the medium. It slowly liquefies coagulated serum.

Inoculated sub-cutaneously into guinea-pigs it produces sometimes a gaseous gangrene with a sub-normal temperature which terminates fatally (adult animals), at other times a septicæmia without local lesions (young animals and pregnant does). The virulence of the organism is maintained with difficulty: it can be increased by inoculating a little lactic acid with the culture.

The experiments of Rosenthal have shown that it is easy to modify the conditions of the growth of the bacillus and to vary the capacity of one and the same strain for living in oxygen-containing media or in those from which air is removed. It is unnecessary perhaps to point out that it is under anaërobie conditions that the bacillus sets up the lesions of gaseous gangrene.

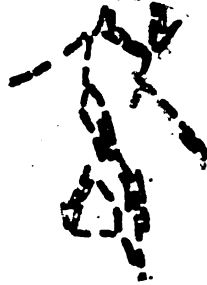

FIG. 273.—*Bacillus aërobieus sepis*.
(After Legros.)

CHAPTER XL.

THE PNEUMOCOCCUS.

Synonyms: *Streptococcus lanczolatius*: *Micrococcus pasteurii*.

Introduction.

Section I.—Experimental inoculation, p. 581.

Section II.—Morphology, p. 582.

1. Microscopical appearance and staining reactions, p. 582. 2. Cultural characteristics, p. 584.

Section III.—Biological properties, p. 585.

1. Vitality and virulence, p. 585. 2. Bio-chemical reactions, p. 586. 3. Toxins, p. 586. 4. Vaccination, p. 587. 5. Serum therapy, p. 588. 6. Agglutination, p. 589. 7. Precipitins, p. 590. 8. Immune body, p. 590.

Section IV.—Detection, isolation and identification of the pneumococcus, p. 590.

THE pneumococcus is the infecting agent in acute lobar pneumonia (Talamon, Fränkel), but this does not represent the limit of its aetiological rôle for it is concerned in by far the greater number of the complications of pneumonia, as well as in certain other affections.

(i) The pneumococcus is frequently found in the saliva of *healthy persons* (Pasteur and others). Netter found it in the saliva of persons who had recently recovered from an attack of pneumonia in four out of five cases examined, and once out of five cases examined in that of persons who had never suffered from the disease. He showed that during the early stages of the disease the pneumococcus in the saliva of the persons included in the former series was virulent, that it disappeared at the time of the crisis, and reappeared at the end of a fortnight. The pneumococcus is an habitual inhabitant of the tonsillar mucus (Bezançon and Griffon), and Burger isolated it from the mouths of many healthy persons (34 out of 100 examined). In the latter it lives as a harmless parasite in the mouth: but should the resistance of the tissues from any cause become lowered, the organism overcomes the leucocytic defences and invades the lung.

(ii) In *lobar pneumonia*, the pneumococcus is always found in the area of hepatization where it may be present in pure culture or be associated with other micro-organisms, generally streptococci, staphylococci and the bacillus of Friedländer: it occurs also in the characteristic rusty sputum. Some cases of broncho-pneumonia are due to the pneumococcus.

(iii) The pneumococcus occasionally passes into the *blood-stream* and gives rise to complications, often of the nature of a suppuration, in the neighbourhood of the lung or in more distant parts (Friedländer, Talamon, Fränkel). Pneumococcal pus is thick and viscous, very rich in cellular elements and greenish in colour. Suppuration due to the pneumococcus tends to undergo spontaneous resolution.

(iv) Pleurisy, pericarditis—fibrinous or purulent, endocarditis—vegetative or ulcerative, meningitis, nephritis, suppurative parotitis, suppurative arthritis, peritonitis, metritis and abscesses, as *complications of pneumonia* may any or all

of them be due to the pneumococcus, though it is to be remembered that they may be caused equally by any of the other organisms of suppuration.

(v) Over and above such cases as these in which pneumonia is a co-existent symptom, the pneumococcus may also be the *primary cause* of fibrino-purulent pleurisy, sero-fibrinous or suppurative pericarditis (Osler, Banti), conjunctivitis, keratitis, suppurative otitis (Zaufal, Netter), ulcerative endocarditis (Jaccoud and Netter, Weichselbaum), simple or membranous inflammation of the throat (Cornil, Jaccoud, Ménétrier, Rendu and Baulloche), peritonitis, and suppuration of the biliary passages.

(vi) The pneumococcus is also the primary cause of a large number of cases of *meningitis*, frequently of the cerebro-spinal type: Netter found this organism in eighteen out of thirty-one cases of meningitis neither accompanied nor followed by pneumonia.

The pneumococcus is the cause of a small minority of cases of epidemic cerebro-spinal meningitis (Foa, Landouzy) though it is now well known that epidemic cerebro-spinal meningitis is usually due to the *Meningococcus* (*q.v.*).

Marchoux has described an epidemic of cerebro-spinal meningitis among the natives of Senegal which occurred coincidentally with numerous cases of pneumonia and which was caused by the pneumococcus.

SECTION I.—EXPERIMENTAL INOCULATION.

Mice are the most susceptible animals: then in order of decreasing susceptibility come rabbits, rats, sheep, guinea-pigs and dogs. Pigeons are immune.

Mice.—Sub-cutaneous inoculation of a small quantity of a culture of the pneumococcus or of a pneumococcal exudate invariably leads to the death of the animal in 12–30 hours. Mice succumb as the result of a pneumococcal septicæmia without showing any pulmonary symptoms: at the site of inoculation only is there a little œdema. *Post mortem*, there is no lesion other than an enlargement of the spleen: the blood is black and contains a large number of encapsulated pneumococci, as do also the spleen and other internal viscera, the peritoneum and bone marrow.

Rabbits.—The inoculation of rabbits may be productive of either one of two types of disease according to the virulence of the organism inoculated.

(a) *Inoculation of a virulent virus.*—Sub-cutaneous, intra-peritoneal or intra-venous inoculation leads to the death of the animal from septicæmia in 24–72 hours. There is only a slight local reaction. *Post mortem* the spleen is enlarged and the pneumococcus may be found in the blood and internal organs.

Lobar pneumonia often accompanied by pleurisy on the same side follows inoculation of material into the lung.

(b) *Inoculation with an attenuated virus.*—Sub-cutaneous inoculation proves fatal though much less rapidly than in the former case. There is an inflammatory reaction at the site of inoculation and the animal dies, not from a septicæmia without visceral localization, but from a true lobar pneumonia frequently accompanied by pleurisy, pericarditis, peritonitis, arthritis, etc.

Rats.—Rats only succumb after the inoculation of very much larger quantities of the virus than are necessary to kill mice and rabbits. There is an intense inflammatory reaction at the site of sub-cutaneous inoculation, and the œdema may extend over the whole of the abdominal and thoracic walls: lobar pneumonia not infrequently results. *Post mortem* only a few pneumococci are found in the blood. Intra-pulmonary inoculation produces a patch of lobar pneumonia accompanied by a sero-fibrinous pleurisy.

Sheep.—To produce a fatal infection in sheep by sub-cutaneous inoculation more than 1 c.c. of culture must be used. An extensive œdema develops around the site of inoculation: when death takes place only a few micro-organisms are found in the blood.

Intra-pulmonary inoculation is followed by a fatal attack of pneumonia.

Intra-tracheal inoculation appears to do no harm, though Gamaléia after irritating the respiratory passages by the injection of a solution of tartarated antimony produced a fatal pneumonia by this method.

The vitality and virulence of the pneumococcus become rapidly attenuated by passage through sheep so that serial inoculations are impossible.

Guinea-pigs.—Guinea-pigs are comparatively immune to the pneumococcus. Sub-cutaneous inoculation is followed by a more or less marked local reaction which very often spontaneously resolves. Intra-peritoneal inoculation is more severe and is often followed by death.

Dogs.—Dogs only succumb to extremely large doses. A very extensive œdema is produced as the result of sub-cutaneous inoculation, and on rare occasions death may take place about the fourth or fifth day: the blood will contain a very few pneumococci.

Intra-pulmonary inoculation sets up a pneumonia which runs the same course as in man, but which as a rule resolves.

Intra-tracheal inoculation is generally without effect: Tchistovich however produced a fatal result in 3 out of 19 dogs inoculated by this method. In performing the experiment great care must be taken that the tissues around the trachea are not infected (for technique, see p. 179), otherwise the result will be misleading.

To summarize. *The most susceptible animals die from a pneumococcal septicæmia. Pneumonia occurs more often in the less highly susceptible animals. Further, in accordance with the general rule, the severity of the infection is in inverse ratio to the extent of the local lesion.*

SECTION II.—MORPHOLOGY.

1. Microscopical appearance and staining reactions.

The pneumococcus presents under the microscope two different appearances according as to whether it has been obtained from human or animal tissues or from cultures on artificial media. In cultures on liquid albuminous media (serum, or broth containing fresh blood, etc.) the pneumococcus has however the same characteristics as in the tissues.

A. Appearance in the tissues.—The pneumococcus in sputum, blood, scrapings of organs, etc. occurs as a coccus, sometimes rounded but generally

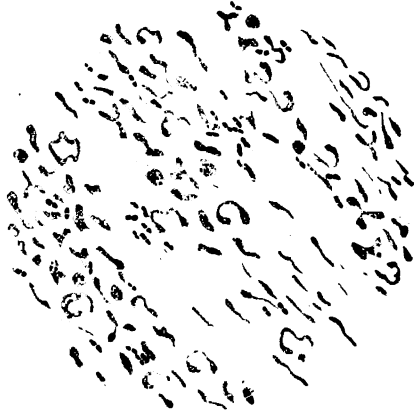

FIG. 274.—Pneumococcus in sputum. Gram's stain and dilute carbol-fuchsin. (Oc. 2, obj. $\frac{1}{4}$ th, Zeiss.)

oval, and slightly pointed at the ends (hence the comparison with grains of barley or a candle flame and the synonym *Diplococcus lanceolatus*). Two cocci are generally joined together—with their long axes in the same straight line, like a figure of 8—forming a diplococcus, but here and there a few single cocci may be found, and sometimes short chains composed of three or four cocci. The organisms whether occurring as single cocci, diplococci or in chains are surrounded by a capsule or areola, which is a sort of albuminous envelope: this capsule can be stained by appropriate methods.

The pneumococcus varies considerably in size: 0.5 or 0.75μ to 1 or 1.25μ .

Staining reactions.—The pneumococcus is readily stained with the basic aniline dyes and is gram-positive. The following methods are recommended for diagnostic purposes.

(a) **Nicoll's method. Recommended.**—Films prepared in the ordinary way are stained with carbol-thionin for some seconds then passed quickly through alcohol-acetone (1 to 3), washed, dried and mounted.

(b) **Gram's method.**—Gram's method should always be used in the identification of the pneumococcus; blood-films give very pretty preparations. The double staining method recommended on p. 207 should be adopted. The capsules, as a rule, remain unstained.

(c) **Capsule staining.**—The method (a) recommended above for staining the pneumococcus will stain the capsules: several other methods of capsule staining applicable to the pneumococcus have already been described in the earlier part of the book (p. 147).



FIG. 275.—*Pneumococcus*. $\times 1000$.
Stained to show capsules.

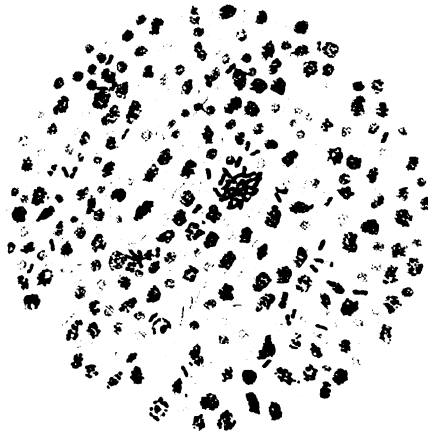

FIG. 276.—*Pneumococcus*. Section of lung. Gram's stain and eosin.
(Oc. 2, obj. 13th, Zeiss.)

(d) **Section staining.**—(i) Sections are best stained by Gram's double or triple stain (p. 219). Weigert's method may also be used (p. 216).

(ii) It is a somewhat difficult matter to stain capsules in sections: one or other of the following methods may be tried.

Friedlander's method.—1. Stain the section in the following solution for 24 hours :

| | |
|--------------------------------|----------|
| Fuchsin, - - - - - | 1 gram. |
| Absolute alcohol, - - - - - | 5 grams. |
| Glacial acetic acid, - - - - - | 2 " |
| Distilled water, - - - - - | 100 " |

2. Wash in alcohol and then in 2 per cent. acetic acid for 2 minutes.

3. Wash in distilled water, dehydrate in absolute alcohol, clear in clove oil or xylol and mount in balsam.

Ribbert's method.—1. Stain the section for a few minutes in the following solution :

| | |
|---------------------------------|----------------------------------|
| Distilled water, - - - - - | 100 grams. |
| 95 per cent. alcohol, - - - - - | 50 " |
| Glacial acetic acid, - - - - - | 12.5 " |
| Violet-dahlia, - - - - - | Q.S. to saturate in the warm. |

2. Wash in water, dehydrate in absolute alcohol, clear in clove oil or xylol, and mount in balsam.

B. Appearance in cultures.—In cultures on artificial media generally the pneumococcus is not encapsulated ; capsules are only found in cultures in liquid serum or blood-broth.

In cultures, the pneumococcus appears either as lancet-shaped cocci, or as rounded grains : the latter may be found to the absolute exclusion of the lanceolate forms. The organism may occur as single cocci, as diplococci, or in short streptococcal chains of 3 to 8 elements : the chains consist of chains of diplococci, the long axes of the cocci being disposed along the line of the chains. The latter are especially numerous and long in broth cultures.



FIG. 277.—*Pneumococcus*. Surface culture on agar (3 days at 37° C.).

2. Cultural characteristics.

Conditions of growth.—The pneumococcus is a facultative aërobie. Growth does not take place below 25° C. so that the organism cannot be cultivated on ordinary gelatin. The optimum temperature is about 35°–37° C., and development ceases at 42° C. Growth is more vigorous in liquid than on solid media, and the medium must be faintly alkaline : ordinary media are not very suitable for cultivating the pneumococcus.

Agar.—After incubating for 24 hours at 37° C. a delicate growth of small transparent colonies resembling drops of dew is seen. The colonies are difficult to see and are never confluent.

Coagulated serum.—The growth is similar to that on agar, but differs from the latter in that the colonies occasionally coalesce and form a thin semi-transparent film.

Burger's serum (p. 590).

Broth.—After incubating at 37° C. for 24 or 36 hours the medium is very slightly cloudy : a very delicate powdery deposit is precipitated later. Broth containing 8 per cent. glucose is a much better medium than ordinary broth (Turrô).

Broth containing rabbit's blood.—To prepare this medium a little blood is collected aseptically from the ear vein of the rabbit (p. 194) and added to sterilized broth in the proportion of 1 part of blood to 3 or 4 parts of

broth. In this medium the pneumococcus grows abundantly at 37° C. producing a marked cloudiness of the medium and later a mucoid precipitate very rich in micro-organisms.

Liquid serum.—The best serum is that prepared with young rabbit blood collected aseptically and not heated: in such a serum a very copious growth is obtained on incubating at 37° C. At first the medium is thickened and becomes markedly turbid, and later a heavy precipitate composed of capsulated pneumococci is thrown down.

Milk.—The pneumococcus coagulates milk [but not invariably, see p. 602].

Potato.—No growth takes place on this medium.

Inulin media.—American observers recommend media containing inulin for isolating and differentiating the pneumococcus. The pneumococcus does not ferment inulin, herein presenting a contrast to the streptococci (*cf.* p. 602).

Hiss uses the following medium: To 1 part of ox serum add 2 parts of distilled water and 1 part per cent. of litmus solution. Heat to 100° C., add 1 per cent. of inulin and sterilize on three successive days at a low temperature.

Ruediger recommends the following medium for the isolation of the pneumococcus: to 1 litre of broth add 15 grams of agar and 15 grams of inulin and, after sterilization, 20 c.c. of a 5 per cent. solution of Merck's litmus. Distribute in tubes and to each tube add 1 c.c. of ascitic fluid.

SECTION III.—BIOLOGICAL PROPERTIES.

1. Vitality and virulence.

I. In sputum and in albuminous exudates the pneumococcus retains its vitality and virulence for a long time and can resist even prolonged desiccation (Bordoni): it also shows prolonged vitality in the soil and in dust. Emmerich found virulent pneumococci in the dust between the joists in wards where pneumonia patients were lying, and Uffelmann discovered the organism in the air of a vault.

II. In artificial cultivation the pneumococcus soon loses its virulence and even its vitality. Cultures on solidified serum and on agar die after 4 or 5 days; cultures in liquid media remain alive longer, but are avirulent at the end of a week. The less suited the medium is to the growth of the pneumococcus the more rapidly does the virulence diminish; thus it disappears more quickly in ordinary broth than in blood-broth. According to Bezançon and Griffon, the pneumococcus will live for a year in defibrinated blood containing ascitic fluid. (In this medium the pneumococcus appears as chains: sown afterwards on agar or broth it preserves this inherited appearance but reverts to the diplococcal form in rabbit-serum.) Defibrinated rabbit or dog blood either pure (Gilbert and Fournier) or, better still, blood-agar (Bezançon and Griffon) may also be used as media on which to preserve the vitality of the organism. In ordinary media the virulence rapidly diminishes and is altogether lost in the third sub-culture.

Cultures are sterilized in 24 hours at a temperature of 42° C.; in 10 minutes at 56° C. and instantly at 65°–70° C. Desiccation rapidly kills the organism in culture.

Pasteur showed that the attenuation in culture is largely due to the action of the oxygen of the air; hence it follows that the virulence can be maintained for a long time in anaërobic culture (Fränkel). In cultures on egg sown as described on p. 53 (A) the organism will remain virulent for several months (Bunzl-Federn). An efficient method of preserving the virulence of the pneumococcus is to inoculate the culture into a rabbit, collect a little of the heart-blood *post mortem*, and store it in a sealed pipette: in the pipette the blood retains its virulence for a very long time. For future experiments sow the blood in broth, incubate for 24–36 hours and inoculate the culture.

Another cause of the attenuation and death of the pneumococcus in culture is the rapidity and extent to which it forms acid (for the most part formic acid). The addition of calcium carbonate to the medium neutralizes the acid as it is formed, and in this way the vitality of the organism can be preserved for more than a month (Wurtz and Mosny). According to Bolduan, the calcium salt maintains the life of the culture not because it neutralizes the acid but on account of a special action of the calcium on the pneumococcus.

Restitution and exaltation of virulence.—(a) The virulence of an attenuated pneumococcus can be restored by inoculating into a rabbit fairly large doses (1 c.c.) of a broth culture of the organism and at the same time an equal quantity of a filtered culture of *Proteus vulgaris*. The animal will die from a pneumococcal septicæmia and the organism in the blood will be found to be virulent.

(b) The virulence of the pneumococcus can be increased by passages through rabbits. Intra-venous inoculation is better for this purpose than sub-cutaneous, but intra-peritoneal inoculation is a more certain method than either (Issaëff).

Inoculate 1 or 1.5 c.c. of the blood of a rabbit dead of a pneumococcal septicæmia into the peritoneum of a rabbit (A). Inoculate a second rabbit with the blood of A and so on in series until eight or nine rabbits have been inoculated. The amount of blood inoculated is at this stage diminished; for the eleventh rabbit, for instance, 6 or 8 drops of the virus are sufficient.

From about the twelfth passage onward the blood loses its power of coagulation, becomes extremely toxic and virulent and contains very numerous pneumococci. One drop of this blood inoculated into the peritoneum of a rabbit will prove fatal in 10 or 12 hours: if too large a dose (for example 1–2 c.c.) be given the rabbit will die very quickly (5 or 6 hours) of toxæmia and not of septicæmia.

Sub-cutaneous inoculation of 4 or 6 drops of blood containing a pneumococcus the virulence of which has been increased in this way will kill rabbits in 12 or 15 hours. It is to be noted however that after a long series of passages through rabbits the virulence of the organism becomes attenuated but can be restored by two or three passages through another species such as the guinea-pig or dog.

2. Bio-chemical reactions.

The bio-chemical reactions of the pneumococcus and the characteristics which distinguish this organism from the streptococci are described on p. 602.

3. Toxins.

(i) Filtered cultures of the pneumococcus are only slightly toxic. If inoculated in large quantities into the veins of rabbits they give rise to a transitory rise of temperature and loss of weight: death does not generally result.

A somewhat more toxic product is obtained by sterilizing cultures of the organism by chloroform or heat (a temperature of 58° C. for 2 hours will sterilize the culture without altering the toxin). Cultures on young rabbit-serum yield the most powerful toxin.

Anaërobic cultures in broth or serum which are kept alkaline offer no advantage from the point of view of toxin production.

The brothers Klemperer isolated a toxin by precipitating filtered broth cultures with alcohol or sulphate of ammonia: Foa and Carbone obtained similar results. Andreini attributed the toxicity of cultures to an alkaloidal base.

(ii) Emmerich obtained a more toxic product by crushing and expressing the organs of rabbits which had died of a pneumococcal septicæmia and filtering the juice through a bougie. Mosny modified this method as follows:

Immediately after death the organs of the rabbit are minced and macerated in

twice their weight of water for 24 hours, a few pieces of thymol being added as an antiseptic. The fluid is then filtered several times through paper and finally through a Chamberland bougie.

(iii) From the blood of rabbits killed by his virulent virus (*vide ante*) Issaëff obtained a toxin capable of killing rabbits on intra-venous inoculation when administered in a dose equivalent to one one-hundredth of the weight of the animal. The toxicity of the product is considerably diminished by heating it to 70° C., and is destroyed at 100° C. His method is as follows :—

1. Collect under aseptic precautions the heart-blood of three or four rabbits which have recently succumbed to the inoculation of a virulent pneumococcus (80–100 grams of blood) and mix the various samples in a sterile vessel.

2. Add an equal volume of sterile water containing 1 per cent. of glycerin and 5 or 6 drops of a saturated solution of bicarbonate of sodium per 100 c.c. Mix.

3. Filter the mixture through a Chamberland bougie.

The toxicity of the product is much diminished by heating to 70° C. and destroyed at 100° C.

By filtering pleural and peritoneal exudates of rabbits which had died after the inoculation of a virus of increased virulence Issaëff was also able to obtain a product sufficiently toxic to kill rabbits.

4. Vaccination.

(i) **With toxins.**—It is possible to immunize an animal against the pneumococcus by inoculating it with filtered cultures or with toxins prepared by the methods of Emmerich, Mosny or Issaëff; the immunity however is of short duration, and to render the animal more permanently immune it must be inoculated afterwards with living cultures.

A. Heat the serum of rabbits which have died of a pneumococcal infection to 58° C. and inoculate it in doses of 10–20 c.c. into the ear vein of a fresh rabbit. After four or five inoculations at intervals of a few days the animal is able to resist the inoculation of virulent cultures (Foa).

B. A similar result is obtained by inoculating in the same way toxins prepared by the methods of Emmerich or Mosny.

C. Issaëff immunizes rabbits by inoculating into the veins at intervals doses of 10–50 c.c. of sterilized cultures (broth or serum). Each inoculation is followed by a fairly sharp reaction so that the next inoculation must be withheld until the animal appears to have completely recovered from the previous experiment.

The same observer has also immunized rabbits by inoculating them with toxins extracted from the blood as described above. A single injection of 10 c.c. of toxin into the blood or peritoneal cavity is sufficient to render rabbits highly immune against the pneumococcus.

The immunized animals are tested by inoculating them sub-cutaneously with the blood of a rabbit just dead of a pneumococcal infection; on the first occasion 2–4 drops and on the second 0·5 c.c. of the blood are administered. To keep up the immunity the animal should be re-inoculated once a month with a dose of not more than 0·5 c.c. sub-cutaneously. Before giving the test inoculation it is necessary to wait until the animal has completely recovered from the effects of the immunization and until the weight has begun to increase.

D. Neufeld and Händel immunized horses by inoculating them intra-venously with organisms killed by heat. Highly virulent cultures in broth were heated to 60° C. and centrifuged. The organisms alone were inoculated: the animals tolerated the inoculations very well even when they were repeated in very large doses at frequent intervals. The resulting serum was rich in thermostable substances which assisted the phagocytosis of virulent pneumococci; a dose of 2 c.c. intra-peritoneally immunized mice against the inoculation of 0·1 c.c. of a very virulent culture.

Rabbits vaccinated with toxin are absolutely immune to infection with living cultures, but not to toxins, to which they react even more violently than do normal rabbits.

(ii) **With attenuated cultures.**—Animals can be immunized by inoculating them with living cultures the virulence of which is attenuated by age. Thus, for example, broth cultures 5 or 6 days old are used for the first inoculation, and the immunization is continued by using younger and younger cultures, until finally a 24-hour growth, or a dose of virulent blood, is inoculated (Foa and Scabia, Netter, Washbourn).

(iii) **With stained cultures.**—Sergent sows agar cultures with the blood of a rabbit which has died of a highly virulent pneumococcal infection. After incubation the growth is scraped off and made into an emulsion with sterile normal saline solution containing a few drops of a sterile aqueous solution of crystal-violet. After about an hour all the organisms are stained but are still living and on sub-culture give rise to a new culture. A volume of this stained emulsion equivalent to one-tenth of an agar culture will kill rabbits in 12–48 hours when inoculated sub-cutaneously, but it produces no effect if inoculated intra-venously or intra-peritoneally. Rabbits which have received several of these harmless intra-venous or intra-peritoneal inoculations at intervals of 6–8 days (the dose of emulsion inoculated may be progressively increased) are able to resist the inoculation of a quantity of a virulent culture which is sufficient to kill a normal animal in less than 24 hours. These rabbits are more highly immunized than animals vaccinated with sterilized cultures.

(iv) **With bacteriolized cultures.**—Neufeld found that if 0·1–0·2 c.c. of rabbit bile was added to 2 c.c. of a 24-hour-old broth culture of the pneumococcus the culture became clear in 15–20 minutes: the cocci were killed and bacteriolized and disappeared entirely. The same result is obtained by using a 5 per cent. solution of cholate or taurocholate of sodium instead of bile. Other micro-organisms, and especially the pyogenic streptococci, are not destroyed under these conditions.

Neufeld, Nicolle and Adil Bey, have shown that rabbits can be highly immunized by a single inoculation of 2 c.c. of a culture bacteriolized as above.

5. Serum therapy.

(i) The blood of animals naturally immune to the pneumococcus has neither therapeutic nor immunizing properties.

(ii) The blood of vaccinated animals is not antitoxic and is incapable of neutralizing the toxins of the pneumococcus either *in vitro* or *in vivo* (Issaëff).

(iii) The serum of vaccinated animals has no bactericidal action on the pneumococcus *in vitro*. The pneumococcus will grow in the serum but somewhat poorly and will retain its virulence though it undergoes some morphological modifications—the rounded forms predominate and the micro-organisms are agglutinated in clumps (Behring and Nissen, Issaëff).

In verifying the virulence of a pneumococcus grown in the serum of a vaccinated animal it is necessary to exclude a source of error which may arise from inoculation of the entire culture. The culture is composed of two parts: (1) the micro-organisms and (2) the serum which serves as the culture medium and which, as will be seen immediately, has the power of conferring immunity. If the whole culture be inoculated the animal being immunized by the serum inoculated with the organisms will survive the inoculation, and the—erroneous—conclusion will be that the serum is bactericidal. One or other of the following devices must therefore be adopted.

(a) Sow a trace of the serum culture into a tube of broth and inoculate the broth culture. This method is open to criticism.

(b) Pour the serum culture on a sterilized filter paper. Wash the organisms two or three times with sterile normal saline solution. Collect the residue with a brush, dilute it in 2 c.c. of a normal saline solution and inoculate the emulsion sub-cutaneously.

(iv) The serum of vaccinated animals has both prophylactic and thera-

peptic properties which depend upon phagocytosis and not upon any bactericidal or antitoxic properties.

The serum of a satisfactorily vaccinated rabbit is very potent; 2 or 4 drops of the serum of such a rabbit is sufficient to immunize a mouse (Foa and Carbone): Neufeld and Handel's serum protects mice against 100,000 fatal doses (*vide ante*).

G. and F. Klemperer arrested a pneumococcal septicæmia in a rabbit infected 24 hours previously by inoculating it with 8 c.c. of the serum of a vaccinated rabbit. Tizzoni and Panichi prepared a serum which exhibited therapeutic properties for the rabbit when given intra-venously in doses of 0.25 per 1000 of the weight of the animal.

The same observers have shown that at the moment of the crisis in human lobar pneumonia the serum of the patient—which is toxic during the febrile period—acquires immunizing and therapeutic properties.

Therapeutic applications.—Many observers relying upon the satisfactory results obtained in laboratory experiments have treated pneumococcal infections in the human subject with immunized rabbit serum and with the serum of patients who have survived the crisis. The results so far obtained though satisfactory are not sufficiently striking to warrant the method being generally adopted.

Klemperer has shown that the inoculation of antipneumococcal serum into the healthy human subject is unaccompanied by any untoward symptoms. In cases of pneumonia he inoculated immunized rabbit serum in doses of 6 c.c. sub-cutaneously with favourable results. Foa and Carbone provoke the crisis on the fourth day by giving two consecutive inoculations of 5 c.c. of the immunized rabbit serum. Foa and Scabia and also Janson also noticed a rapid improvement in several cases of pneumonia following the injection of 5–25 c.c. of the serum of a vaccinated rabbit. Neufeld and Handel recommend the inoculation of large doses of their serum: Römer favours the use of a polyvalent serum: Pane uses immunized ass serum.

Audéoud inoculated cases of pneumonia with 2–4 c.c. of blood taken from patients who had passed the crisis, and in two of them he obtained a marked improvement and a fall of temperature in 15 hours after the inoculation. Bouchard, Roger, Charrin, Maragliano have obtained favourable results under similar circumstances.

For the purposes of these experiments the blood can be collected from cases of pneumonia in the early stages of convalescence without causing any inconvenience, by adopting the technique described on p. 193.

6. Agglutination.

In pneumococcal infections the serum of man and the lower animals acquires the property of agglutinating the pneumococcus. The agglutinating power is never other than feeble: it cannot be demonstrated by the Grünbaum-Widal method but only in undiluted serum cultures (Bezançon and Griffon).

The serum must be collected aseptically and should not be stained with hæmoglobin. It is sown with a trace of culture on normal rabbit-serum and incubated at 37° C. for 15 or 16 hours.

The agglutination may be visible to the naked eye or only evident on microscopical examination. It is very distinct in a drop of culture spread out, dried, and stained (the "Medusa head" appearance of Bezançon and Griffon). The pneumococcus is never agglutinated by normal human, rabbit or dog serum.

In human pneumococcal infections (pneumonia, broncho-pneumonia, sore throat, etc.) the agglutination reaction is always positive, but diminishes during convalescence and soon vanishes altogether.

Agglutination is not obtained with all strains of the pneumococcus; it is in a way an individual and not a specific property. Very often agglutination

is obtained with the micro-organism recovered direct from the infected person while laboratory strains give negative results (Bezançon and Griffon).

7. Precipitins.

The serum of persons suffering from pneumonia and the serum of immunized animals contain specific precipitins for filtered cultures of the pneumococcus.

8. Immune body.

The serums of pneumonia patients (Römer) and of vaccinated animals (Neufeld and Handel) contain specific immune bodies (*Sensibilisatrices*).

SECTION IV.—DETECTION, ISOLATION AND IDENTIFICATION OF THE PNEUMOCOCCUS.

I. Man. A. During life.—To find the pneumococcus in a case of pneumococcal infection the following materials should be examined:—

(a) **Sputum.**—Collect the sputum with the ordinary precautions (p. 191) and with a stout wire remove a small portion from the centre of one of the rusty nodules.

1. Prepare films for microscopic examination (*vide infra*, methods of staining).

2. It is hardly worth while to sow cultures with sputum since the other organisms present will interfere with the growth of the pneumococcus.

American observers have described several ways of isolating the pneumococcus from sputum and saliva. Burger recommends sowing stroke cultures on glucose-serum-agar (p. 53). The agar is prepared with 2 per cent. peptone water to which 2 per cent. glucose is added, and then made neutral to phenol-phthaleïn. On this medium a characteristic culture of the pneumococcus is obtained in 18–20 hours—i.e. ring-shaped colonies with raised edges and depressed centres: by oblique vision the ring is milky, the centre more transparent.

3. Another portion is used for *inoculation*.—Rub up a little of the sputum with sterile distilled water [or normal saline solution] and inoculate the emulsion into the root of the tail of a mouse. If the material be rich in pneumococci the animal will die quickly. When the animal is dead aspirate a little of the heart blood, or take a little of the medulla from one of the long bones—being careful to avoid contaminating it—and sow tubes of agar and broth. Incubate at 37° C.

Inoculation for the purpose of identifying a suspected pneumococcus ought always to be made into a mouse and not into a rabbit. Rabbits are not so susceptible to the disease as mice, and indeed in some cases of pneumococcal pneumonia the sputum contains pneumococci almost avirulent for rabbits (Gamaléia).

(b) **The inflammatory exudate.**—Collect the exudate by putting a syringe needle into an hepatized area (p. 198). The material must be examined by microscopical examination and by inoculation. Bezançon and Griffon prefer to sow the exudate in a young rabbit's serum which has not been coagulated and to inoculate mice with the culture obtained after incubating for 24 hours.

(c) **Pus and inflammatory exudates in other situations.**—The technique is the same as for the material from the lung.

(d) **Blood.**—The pneumococcus is not found constantly in the blood of persons suffering from pneumonia (Foa, Talamon, Klemperer, Widal), though it is usually present in severe cases.

The examination in such cases should preferably be made about the fifth or sixth day. When the disease is likely to prove fatal the pneumococcus can generally

be found in the blood during the last days or last hours of life. The presence of the organism in the peripheral circulation does not however necessarily imply a fatal issue.

The blood should be examined *microscopically, culturally and by inoculation* into mice. The blood can be collected either by pricking the finger or from a vein at the bend of the elbow (p. 193). Widal recommends sowing 5 c.c. of blood in 300–500 c.c. of broth: by this method he has been able to isolate the pneumococcus from the blood of persons suffering from pneumonia in one-third of the cases examined.

B. After death.—(The *post mortem* examination should be made as soon as possible after death.) The examination of the following fluids and tissues will suffice for the detection of the pneumococcus.

(a) **The inflammatory exudate in the lung.**—Cauterize the surface of an hepatized area. Introduce a Pasteur pipette and aspirate the fluid. With the material prepare cover-glass preparations, sow culture media and inoculate a mouse.

(b) **Sections of the lung.**—Put a few small pieces of the hepatized area of the lung at once into alcohol or acid perchloride. They must be subsequently embedded in paraffin, cut and stained by the methods described on pp. 216 and 219.

(c) **Pus and exudates.**—Collect the material in the ordinary way and then prepare films, sow cultures and inoculate a mouse.

II. In animals.—In animals the following tissues and fluids may be examined for the pneumococcus viz. the blood, bone marrow, pleural fluid, peritoneal exudate, pericardial effusion, films and sections of the internal organs, etc.

Blood films and scrapings from tissues should be examined microscopically. Cultures on rabbit serum sown with the blood, bone marrow, and exudate will yield pure cultures which can be used for inoculation of other animals.

Portions of the internal organs for sections should be fixed in alcohol or acid perchloride and embedded in paraffin.

CHAPTER XLI.

STREPTOCOCCI HOMINIS.

Introduction.

Varieties of streptococci, p. 593.

Section I.—Experimental inoculation, p. 594.

Section II.—Morphology, p. 595.

1. Microscopical appearance and staining reactions, p. 595. 2. Cultural characteristics, p. 597.

Section III.—Biological properties, p. 599.

1. Vitality and virulence, p. 599. 2. Bio-chemical reactions, p. 600. Andrewes and Horder's classification, p. 601. 3. Toxins, p. 602. Streptocolysin, p. 603. 4. Vaccination, p. 604. 5. Serum therapy, p. 605. A. Monovalent serums, p. 606. B. Polyvalent serums, p. 608. 6. Agglutination, p. 609. 7. Bordet-Gengou reaction, p. 609.

Section IV.—Detection and isolation of streptococci, p. 609.

The streptococcus of Bonome, p. 610.

STREPTOCOCCI were first described by Pasteur and Doleris who found them originally in the blood of women suffering from puerperal fever.

Streptococci as the primary cause of disease.—Streptococci are the primary cause of many inflammatory, suppurative and septicæmic processes. Thus they are the cause of puerperal septicæmia (Pasteur and Doleris) and erysipelas (Fehleisen): they are a common cause of osteo-myelitis and of purulent surgical affections and have also been found to be the primary infecting agent in certain cases of each of the following among other diseases:—phlebitis, broncho-pneumonia, pleurisy, peritonitis, meningitis, endocarditis, salpingitis, otitis, and dermatitis.

In all pathological conditions of the throat of whatever nature streptococci are to be found either as the primary cause of the lesion or as an associated infection.

[Acute rheumatism is attributed by some observers to infection with a streptococcus (Beattie; Poynton and Paine and others).]

It is now generally conceded that streptococci are not the specific cause of scarlet fever though these organisms are almost constantly present as secondary infections. Weaver, for instance, found streptococci nearly always present in the throat during an attack of scarlet fever. Hektoen, however, only found streptococci in the blood in 12 out of 100 cases of scarlet fever which he examined.

Streptococci as secondary infections.—As secondary infections streptococci are not infrequently found complicating an already existing infective disease and under these conditions are even more dangerous than when acting as primary infections.

They associate themselves with the primary cause of the disease and increase its virulence, as may happen, for instance, in influenza, enteric fever, and diphtheria. Streptococci are also found as secondary infections following infection with the pneumococcus, the tubercle bacillus and the bacillus of hospital gangrene. A great many of the complications of scarlet fever are due to a secondary infection with streptococci.

Streptococci occur in the healthy human subject both on the skin and in those cavities which open on the surface of the body (alimentary canal, nose, and, but rarely, in the vagina). They are present also in the saliva, stools, etc.

Streptococci are also the cause of certain diseases in the lower animals (Chap. XLII).

Streptococci are also found widely distributed in the air, soil, well water, etc. [and wherever found they seem always derived directly or indirectly from the animal body (Andrewes)]. The virulence of the organism appears to be rapidly lost outside the body.

VARIETIES OF STREPTOCOCCI.

The large number of pathological conditions to which the streptococci can give origin and its occurrence as a saprophyte in the healthy human tissues have for long attracted the attention of bacteriologists. The question naturally arises as to whether or no the streptococci found under these different conditions are all identical.

For a time there was a tendency to regard the streptococci as including several species: Fehleisen, for instance, stoutly defended the specificity of the streptococci isolated from cases of erysipelas (*Streptococcus erysipelatos*) and Rosenbach stated that he could with certainty distinguish streptococci obtained from pus (*Streptococcus pyogenes*) from Fehleisen's erysipelococcus.

But Petruschky showed that the same strain of streptococcus would produce indifferently both in man and in the lower animals such varied clinical conditions as erysipelas, suppuration and septicæmia.

[Clinical experience also rendered Fehleisen's and Rosenbach's views untenable: in clinical practice a streptococcus from a case of erysipelas can originate a puerperal infection. "One and the same strain of streptococcus may at different stages in its career produce now a rapidly fatal septicæmia, now a spreading erysipelas, now a localized suppuration and now no effect at all" (Andrewes and Horder). "It may therefore be accepted as an established fact that a streptococcal infection may assume different clinical manifestations depending upon the resistance of the person infected and upon the structure of the tissue invaded and that quite independently of the source whence the organism was originally derived" (Besredka).]

The saprophytic streptococcus which is a normal inhabitant of the [mucous surfaces of the] human body should not be differentiated from the pathogenic streptococcus: its saprophytic character will vanish and its virulence increase under the influence of various determining causes such as traumatism, cold, the ancillary action of other organisms, etc. [Andrewes however is of a contrary opinion and holds that the *S. pyogenes* should be clearly differentiated from the saprophytic streptococci (*vide infra*).]

The marked pleomorphism of the streptococcus also led many observers to classify these organisms according to their microscopical appearances; thus streptococci were divided into *S. tenuis*, *S. brevis*, *S. longus*, etc. But microscopical appearances and cultural characteristics are in the case of the streptococci as in the case of the majority of the bacteria very variable and cannot alone be used as a basis of classification.

Chiefly as the results of the experiments of Marmorek and Aronson the opinion gained ground that there was but a single species of streptococcus which according to the conditions prevailing might cause any one of a number of different pathological conditions.

[Andrewes and Horder from a study of the bio-chemical reactions, morphological appearances and other characteristics of a large number of streptococci from various sources have provisionally but without any idea of finality classified these organisms into six groups (*vide* p. 601).

[Reviewing these conflicting opinions, it may be said that all observers are at least agreed that there are many and important characteristics possessed by all streptococci in common, and that the controversy hinges on the question whether the differences which undoubtedly exist between various strains are to be regarded as of minor importance—as those who consider all streptococci identical maintain—or whether as the other side insists these differences are of capital importance necessitating a division of the streptococci into species.]

At the moment it would seem best to take up the position that in the case of the streptococci, as in that of the cholera vibrio, there are several races—one might almost say species, but an authoritative definition of the term is lacking.

[The subject is not merely one of academic interest but is from the point of view of serum therapy of considerable practical importance.]

It is not within the province of this book to discuss the arguments brought forward by the opposing theorists—the subject is still one of the most acutely discussed problems in bacteriology—but the differences between various strains of streptococci will have to be noticed as will also the facts upon which the two sides base their conclusions.

SECTION I.—EXPERIMENTAL INOCULATION.

Generally speaking, streptococci isolated from man, even from severe infections, are only slightly virulent for animals.¹ Consequently, the first inoculation of a streptococcus of unknown virulence should be made with a large dose of culture either into the veins or into the peritoneal cavity. The virulence of the organism for animals is rapidly increased by passage through animals.

Rabbits.—Rabbits are the most useful animals for the study of the experimental disease. For purposes of inoculation cultures 2 or 3 days old should be used (*vide infra*).

A. Sub-cutaneous inoculation.—As a rule, the animal is inoculated beneath the skin of the ear; this enables the progress of the lesion to be readily observed. According to the virulence of the organism an inoculation of 10–20 drops of culture will produce one of the following results:

- (a) A small abscess.
- (b) A temporary erysipelatos blush.
- (c) An erysipelas involving the whole ear, possibly becoming phlegmonous but not ending in generalization.
- (d) A phlegmonous erysipelas followed by suppurative arthritis and ending in death in 15–30 days. Streptococci cannot, as a rule, in this case be found either in the articular pus or in the blood after death.
- (e) A rapidly fatal septicæmia ending in death in a few days. Streptococci can be found in the blood *post mortem*.

B. Intra-venous inoculation.—Inoculation of a virulent streptococcus into

[¹ But see later on under the heading of “Virulence.” Streptococci from severe human infections are generally of the *pyogenes* variety and are pretty virulent for mice at least (Andrewes).]

the veins leads to a septicæmia fatal in 24–48 hours; streptococci are present in the blood in very large numbers.

With a less virulent organism, localized foci of suppuration form on serous surfaces; from these the animal may recover but death often takes place within 10–20 days. In such cases streptococci are not found in the blood.

C. Intra-peritoneal inoculation.—Inoculation into the peritoneal cavity is followed by as severe an infection as inoculation into the veins. A virulent streptococcus will kill a rabbit in 24–72 hours.

The virulence of a given streptococcus for the rabbit may be indefinitely increased by passage through rabbits. Marmorek, for instance, was able to increase the virulence of a streptococcus to such an extent that one-millionth and even one-thousand-millionth of a cubic centimetre of a broth culture was sufficient to kill a rabbit when inoculated into the peritoneal cavity.

Mice.—Mice are almost as susceptible to infection with streptococci as rabbits. A virulent streptococcus inoculated beneath the skin will kill a mouse in 24–72 hours. In the case of less virulent organisms death does not occur so soon and is preceded by the formation of abscesses.

Guinea-pigs.—Guinea-pigs are less susceptible than rabbits and mice. The inoculation of a virulent streptococcus beneath the skin generally gives rise to a local abscess which ultimately resolves.

If the virulent passage streptococcus of Marmorek be inoculated into the peritoneal cavity in quantities of not less than 0.2 c.c., a purulent peritonitis and bacteræmia results which is fatal in about 15–20 hours.

Large animals.—Of the larger animals, asses and horses are moderately susceptible to infection with streptococci [of average virulence], the latter somewhat less so than the former. Dogs and sheep, on the other hand, are relatively immune.

Man.—Numerous experiments have been carried out on the human subject. The results of inoculation have often been negative, but, on the other hand, in several instances a typical erysipelas has been produced and in one case the experiment terminated fatally.

SECTION II.—MORPHOLOGY.

1. Microscopical appearance and staining reactions.

Streptococci consist of non-motile cocci arranged in chains.

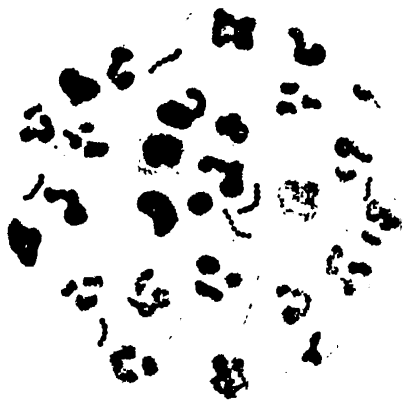

FIG. 278.—Streptococci in pus. Jenner's stain. (Oc. 2, obj. Λ th, Zeiss.)

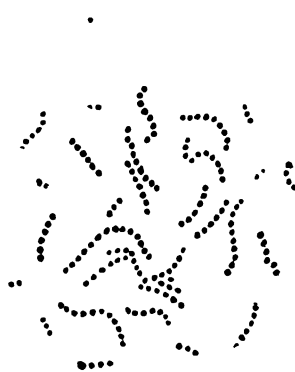

FIG. 279.—Streptococcus. Film from a broth culture. Carbol-crystal-violet. (Oc. III, obj. Λ th, Reich.)

In blood and pus the individual cocci measure $0.6-1\mu$ in diameter, but in cultures their size is subject to considerable variation: they occasionally assume a somewhat oval shape.

The number of cocci in the chains varies. Thus, in a typical streptococcus (*Streptococcus erysipelatos* of Fehleisen, *Streptococcus pyogenes* of Rosenbach) the chains, as seen in preparations from blood and pus or from a culture on a solid medium, will be found to consist of six to fifteen cocci; but when the same organism is grown on a liquid medium the chains will show as many as fifteen to forty and more cocci.

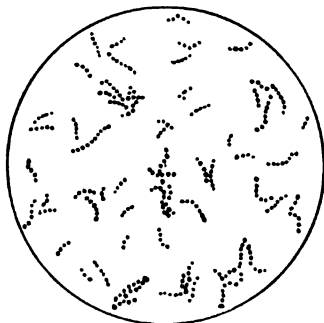

FIG. 280.—Streptococcal chains composed of very small cocci.

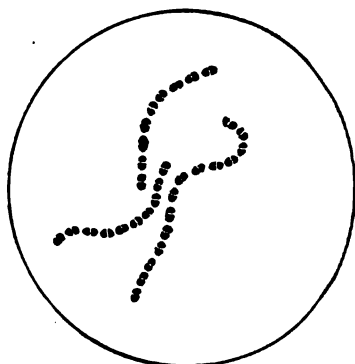

FIG. 281.—Diplococcal streptococci.

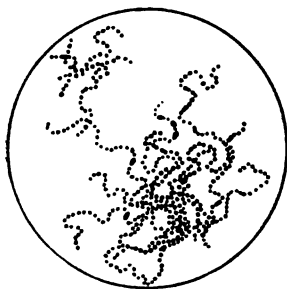

FIG. 282.—*Streptococcus conglomeratus*.

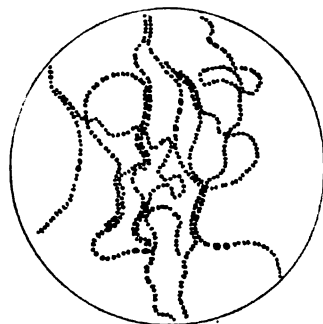

FIG. 283.—Very long chains.

FIGS. 280-283.—Various forms of streptococci. Carbol-fuchsin.
(Oc. 2, obj. 43th, Zeiss.)

Classification on morphological grounds.—Nothing is more variable than the number and even the shape of the cocci forming a streptococcus chain: and hence several types of streptococci have been described (figs. 280 to 283).

The *streptococcus tenuis* of Veillon, found in some cases of sore throat, consists of short chains of two to six very small oval cocci. The *streptococcus brevis* of von Lingelsheim, found in the saliva in some cases of pseudo-membranous inflammation of the throat and also sometimes in pus, is a streptococcus in which the cocci are arranged as diplococci or as chains of four to six diplococci. [The *streptococcus longus* (von Lingelsheim) consists of long chains, and includes most of the strains virulent for man.] The *streptococcus conglomeratus*, which Kurth considered to

be the specific cause of scarlet fever, is characterized by its tendency to form long chains massed together like staphylococci.

Many authors regard these differences in form as accidental. Marmorek who, in common with many other observers, holds that all streptococci are identical, has shown that the number, shape and arrangement of the cocci in the chains can be altered at will by modifying the composition of the culture medium (fig. 284).

Practically all bacteriologists are now agreed that these purely morphological differences are insufficient to justify a differentiation into species.

Staining reactions.—Streptococci stain readily with the ordinary basic aniline dyes and are gram-positive.

It is to be noted however that there are streptococci which do not stain by Gram's method. Von Lingelsheim, for instance, described a gram-negative streptococcus, Etienne found a similar strain in a case of sore throat, and other instances of gram-negative streptococci have been recorded. Lemoine isolated a gram-variable streptococcus from a case of erysipelas. [But Andrewes and Horder, and Gordon, found no gram-negative streptococci during their researches provided they used decently vigorous cultures. The reaction to Gram's stain depends partly upon whether Gram's method or the individual observer's modification be employed and partly upon the age of the culture. It is far from uncommon to find dead and dying cocci in a chain gram-negative (Andrewes).]

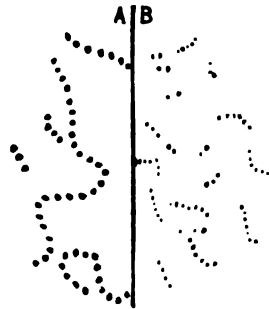

FIG. 284.—Different appearances presented by the same streptococcus (A) when grown on agar and (B) when grown in serum-broth. (After Zenoni.)



FIG. 285.—*Streptococcus pyogenes*. Stab culture in gelatin (5 days at 22° C.).



FIG. 286.—*Streptococcus pyogenes*. Surface culture on agar (4 days at 37° C.).

2. Cultural characteristics.

Conditions of growth.—Streptococci are facultative aërobic organisms [and grow anaërobically quite as well as aërobically (Andrewes).] Growth takes place between 20° and 46° C., the optimum temperature being 37°-38° C. [Andrewes and Horder point out that all pathogenic streptococci grow best at the temperature of the body but while some are capable of vigorous growth at 20° C. others are altogether incapable of growth at that temperature.]

Streptococci require a neutral or slightly alkaline medium and grow better on media containing serum or blood than on the ordinary laboratory media.

Characters of growth. Broth.—A typical pathogenic streptococcus does

not render broth turbid. After incubating for 24 hours at 37° C. the growth takes the form of a light flocculent precipitate adhering to the walls of the tube which, increasing in amount for the next 3 or 4 days, ultimately falls to the bottom forming a somewhat abundant greyish deposit: the reaction of the medium is then distinctly acid (lactic acid).

Some streptococci, however, and especially the short chain forms produce a turbid growth after incubating for 24 hours at 37° C. : later finely granular masses appear in the medium and these after 3-5 days' growth fall to the bottom leaving the medium clear.

[Aronson uses glucose-broth for growing streptococci]: and according to Ucke, 5 per cent. glycerin-broth is a very useful medium for the growth of the organism.

Marmorek's phenomenon.—If a broth culture of a streptococcus be filtered and the filtrate be then resown either with the same or with another strain of streptococcus the organism fails to grow while any other organism, e.g. a staphylococcus, a pneumococcus, etc., will grow abundantly. This failure to grow in a filtered broth culture is common to all streptococci found in human disease processes; it is to be noted, however, that streptococci isolated from cases of scarlet fever may give a very poor growth. The streptococcus of strangles (Chap. XLII.) can, by means of this test, be readily distinguished from all other streptococci: in a streptococcal filtrate this organism grows almost as well as any other organism. Marmorek quotes this experiment as a valuable argument in favour of his view that all streptococci of human origin are identical.

Liquid serum.—Fresh rabbit serum is a very favourable culture medium, but ascitic fluid and bovine and horse serum alone, without any addition, are not particularly useful: the growth on the latter media is poorer than in broth but otherwise has similar characteristics.

Serum-broth and blood-broth.—Marmorek recommends the following media as giving rich and virulent cultures.

- (a) Equal parts of peptone-broth and human serum. The best.
- (β) Equal parts of peptone-broth and ascitic or pleural fluid.
- (γ) One part of peptone-broth and two parts of horse, mule, or donkey serum.

The characteristics of the growth are similar to those on broth.

[Besredka keeps his stock cultures of streptococci in a mixture consisting of equal parts of Martin's broth and heated (56° C. for ½ hour) horse serum. This observer finds that the organisms remain alive in this medium for a long time and retain their virulence well.]

Milk.—When streptococci are grown in milk the medium is coagulated usually after 4 or 5 days, occasionally later. In some cases no clot is formed. [Andrewes and Horder found that among the streptococci pathogenic for man studied by them, the commonest, which they describe as *S. pyogenes*, does not coagulate milk. On the other hand those which they refer to the groups *S. salivarius*, *S. anginosus*, *S. faecalis* all produce clot in milk (*vide infra*). Schottmüller's *Streptococcus pyogenes* does not clot milk.]

Gelatin.—The growth in gelatin stab culture is poor and consists of isolated, circular, opaque-white colonies barely the size of a pin's head. Growth ceases about the fifth day and the organisms soon die. [As already pointed out some streptococci do not grow at all at the temperature of solid gelatin, 20° C.]

[As a rule] the medium is not liquefied. [Andrewes and Horder, however, isolated a few pathogenic streptococci which liquefied gelatin. *S. faecalis* (*vide infra*) liquefies gelatin far more commonly than *S. pyogenes*.]

Agar.—After incubating for 12-24 hours at 37° C. a number of small whitish colonies, resembling grains of semolina, appear along the line of sowing. On further incubation the colonies increase in size, and may become confluent forming a somewhat thin, semi-opaque, greyish band with more or less sharply defined edges. The culture soon dies out.

[**Blood-agar.**—Schottmüller used a medium consisting of 2 parts of sterile human blood mixed with 5 parts of ordinary agar.

[By the characteristics of the growth on this medium, Schottmüller considered that streptococci could be divided into three groups.

[1. *Streptococcus pyogenes* vel *erysipelatos* which is a long-chained form giving rise to greyish colonies and hæmolyzing the blood.

[2. *Streptococcus mitior* vel *viridans* growing in short chains and giving origin to greenish colonies but producing very slight hæmolysis.

[3. *Streptococcus mucosus* consisting of capsulated organisms and giving rise to colonies of a mucous, slimy consistency.]

Coagulated serum.—The colonies are more often discrete otherwise the growth is the same as on agar.

Marmorek recommends agar over which a drop or two of human serum has been run.

[**Serum-agar.**—To obtain large quantities of growth for immunizing horses, Besredka uses Roux's bottles 22 × 11 cm. and sows on agar which is watered 1 hour before sowing with 1–1.5 c.c. of heated horse serum (56° C. for $\frac{1}{2}$ hour.)]

Potato.—No growth apparent to the naked eye takes place on potato though if the surface of the medium be scraped and the scrapings examined under the microscope it is evident that some multiplication has taken place. The chains are always short. Marot has described a streptococcus giving rise on this medium to small discrete whitish colonies visible to the naked eye.

SECTION III.—BIOLOGICAL PROPERTIES.

1. Vitality. Virulence.

Vitality.—Under aërobic conditions, streptococci soon die out in artificial culture. Cultures more than a fortnight old often fail when resown.

When sub-cultivated from agar to agar the organism soon dies out, but in broth sub-cultures can be maintained for a much longer time. Marmorek's [and Besredka's] serum media are better for keeping the organism alive. Sub-cultures from agar can often be obtained by sowing in serum-broth when they fail on ordinary media. Meyer and Ruppel kept streptococci in human blood sealed up in tubes in the ice chest and found that they retained both their vitality and virulence for years.

In culture, streptococci are readily destroyed. A temperature of 52° C. for 1 hour or 100° C. for an instant suffices to kill the organisms. Antiseptics, even the weakest, are powerfully bactericidal; chloroform vapour, for example, sterilizes cultures of streptococci almost at once.

In pus, especially when dried, the organism is more resistant. A temperature of 100° C. for a few minutes kills it but it will resist ordinary antiseptics for a fairly long time.

[Some of the non-pathogenic forms of streptococci—the *S. equinus* of Andrewes and Horder (*vide infra*)—are highly resistant and will withstand drying on garnets for several months.]

Virulence.—Streptococci soon lose their virulence when grown on the ordinary culture media, but the virulence may be maintained by keeping the organism under anaërobic conditions or in broth containing calcium carbonate or, more certainly still, in human blood or in the serum media of Marmorek [and Besredka]. The virulence is not raised by sub-culturing in the latter media but is maintained for several generations.

Streptococci isolated from human lesions (suppurative lesions, sore throats, septicæmias, etc.) are, as a rule, very slightly virulent for the lower animals and may even be totally non-virulent for rabbits and mice: Veillon's *Streptococcus tenuis* and von Lingelsheim's *Streptococcus brevis* are examples of the

latter type. No relation has been established between the virulence for man and the virulence for the lower animals.

[Andrewes and Horder found that streptococci of their *pyogenes* and *anginosus* groups, which include 145 out of 194 strains examined, were pathogenic to mice when first isolated from the body; those of the *salivarius* and *faecalis* groups were non-pathogenic. In their experience a streptococcus may be the cause of a septicæmia or of an inflammatory affection in man and yet produce little or no effect when inoculated into a rodent, and they formed the opinion that while there was a general correspondence in pathogenic effect upon man and rodents it was not universal.]

Method of increasing the severity of experimental streptococcal infections.—

(a) The pathogenic power of a streptococcus for a rabbit may be increased by inoculating with it sterilized culture of *Proteus vulgaris* (Roger and others).

(b) Vincent has shown that the streptococcus is more virulent for laboratory animals when associated with the typhoid bacillus and its products.

A streptococcal culture, 0·25 c.c. of which inoculated into the veins of a rabbit caused no rise of temperature, led to a fatal septicæmia in an animal which had, previously to inoculation with the streptococcus, been inoculated with a culture of the typhoid bacillus. Cultures of the typhoid bacillus, sterilized by filtration, and inoculated at the same time as a streptococcus render the latter much more virulent. A highly immune animal such as the guinea-pig dies of a streptococcal septicæmia if it be inoculated intra-peritoneally with a mixture consisting of 2 c.c. of a filtered culture of the typhoid bacillus and 1 c.c. of a streptococcus the virulence of which has not been artificially raised.

Exaltation of virulence.—(a) The method recommended for obtaining a very virulent virus for the preparation of toxin is that of Marmorek who increases the virulence of the organism by passage through rabbits. The technique is as follows :

Inoculate a fatal dose of the streptococcus into the ear vein of a rabbit. As soon as the animal is dead, sow some of the heart blood in a tube of human-blood-serum. Incubate at 37° C. for 48 hours and then inoculate a second rabbit with the culture. Sow a second culture and inoculate a third rabbit and so on indefinitely. The virulence can only be maintained by repeated passage through animals. After passage experiments extending over 2 months Marmorek found that the streptococcus was so virulent that 0·000,000,000,01 c.c. sufficed to kill a rabbit. (This exceedingly minute dose diluted with 1 c.c. of broth and inoculated into the peritoneal cavity led to death from septicæmia in 30 hours.)

(b) In a similar manner, Aronson increased the virulence of streptococci by passage through mice.

2. Bio-chemical reactions.

Formation of indol.—Streptococci do not form indol in culture.

Neutral red.—Using ordinary broth tinted with the dye it has been found that some streptococci after anaërobic cultivation for 48 hours change the colour of the medium from cherry red to orange green, while others leave the original colour unaltered (*vide infra*).

Fermentation reactions.—Gordon tested ten “representative” streptococci obtained from disease processes and other sources upon 33 substances of the carbohydrate, glucoside and polyatomic alcohol series.

The medium was made up thus :

| | |
|--|-------------|
| Lemco, - - - - - | 1 per cent. |
| Peptone, - - - - - | 1 ” |
| Test organic substance, - - - - - | 1 ” |
| Sodium bicarbonate, - - - - - | 0·1 ” |
| 10 per cent. watery solution of ordinary solid litmus, - - - - - | 10 ” |
| Water, - - - - - | 87 ” |

and the cultures were incubated for 3 days at 37° C.

[In glucose, fructose, mannose, galactose, maltose and dextrin all the ten streptococci tested gave an acid reaction.

[No acid was formed by any of the streptococci in starch, glycogen, arabin, convolvulin, hesperidin, jalapin, methyl glucoside, saponin, glycol, erythrite or dulcitol.

[In the presence of the following substances some gave an acid reaction. Rhamnose (iso-dulcitol), saccharose, lactose, raffinose, inulin, amygdalin, arbutin, coniferin, digitalin, helicin, populin, salicin, syringin, glycerin, sorbite, and mannite.

[With a view to classifying streptococci according to their bio-chemical characters, Gordon selected from among these last-named substances the following: saccharose, lactose, raffinose, inulin, salicin, coniferin and mannite. He took into account also the reactions in neutral red broth and litmus milk. The reactions with these nine media constitute Gordon's "metabolic" tests for the streptococci.

[Over 1200 strains of streptococci have now been submitted to Gordon's tests. 300 from normal saliva (Gordon), 300 from normal human stools (Houston), 200 from air (Gordon), 172 from milk (Houston), over 200 from disease processes (Andrewes and Horder) as well as a number from air, sewage, milk and the intestines of carnivorous and herbivorous animals (Andrewes).

[Andrewes and Horder have summarized the results obtained and conclude that while in themselves the chemical tests are too arbitrary to form a basis for a systematic classification yet taken in conjunction with other characters "they afford a clue to the nature of any given streptococcus which is invaluable." And as a result of their investigations these observers consider it possible to roughly classify all streptococci into seven groups:

[A. *Streptococcus equinus*.—A saprophytic group apparently derived from the herbivorous intestine. It is chiefly found in air, dust and horse dung: on rare occasions also in human saliva, human stools and urine. So far as is known it is totally devoid of pathogenic properties for man.

[B. *Streptococcus mitis*.—Essentially saprophytic and occurring chiefly in human saliva and faeces but occasionally associated with disease. It is non-pathogenic and is never associated with suppuration.

[C. *Streptococcus pyogenes*.—This group has as its type the classical organism first described by Fehleisen as *streptococcus erysipelatos*. It is pathogenic for man and is typically associated with suppurative processes. It is only occasionally found as a saprophyte.

[D. *Streptococcus salivarius*.—Characteristically found in saliva though it is common in the intestine. This is the type which many authors describe as the streptococcus brevis of the mouth. In many ways it is related to the pneumococcus but is certainly not identical with it being usually non-pathogenic. According to Rosenau *S. salivarius* is a modified pneumococcus.

[E. *Streptococcus anginosus*.—A pathogenic form of *S. salivarius* "and seems to have a special connexion with inflammation of the fauces and with scarlet fever." It occurs in other forms of sore-throat and in the alimentary canal, and also but less commonly in other diseased conditions.

[F. *Streptococcus faecalis*.—This is the typical intestinal streptococcus of man and, according to Gordon, is not found in normal saliva. It is sometimes found in disease processes notably in cystitis.

[G. The Pneumococci.—The distinguishing feature of this group is the presence of a capsule when growing in the animal body and on certain special media. The cocci frequently form chains and for this reason, and because the capsule is not formed on ordinary media, Andrewes and Horder are of opinion that "there seems no justification for removing the pneumococci from the genus streptococcus."

[The chemical characters, pathogenic properties, etc. of each of the groups are shown in the subjoined table which has been compiled from Andrewes and Horder's papers in the *Lancet*, 1906 ii.]

| TYPES. | GORDON'S "METABOLIC" TESTS. | | | | | | | | Growth in Gelatine at 20° C. | Morphology. | IN MAN. | | Pathogenesis for mice on isolation. | |
|----------------------|-----------------------------|---------------------------|-------------|----------|------------|---------|----------|------------|------------------------------|-------------|----------|--------------------------|-------------------------------------|--------------------------|
| | Clot in milk. | Reduction of Neutral red. | Saccharose. | Lactose. | Raffinose. | Inulin. | Salacin. | Coniferin. | | | Mannite. | Definitely Pathogenic. | | Associated with disease. |
| <i>S. equinus</i> - | . | . | + | . | . | . | + | + | . | . | Medius | Non-pathogenic. | | . |
| <i>S. mitis</i> - | . | ± | + | + | . | . | ± | ± | . | + | Brevis | Almost never pathogenic. | | . |
| <i>S. pyogenes</i> | . | . | + | + | . | . | ± | . | . | + | Longus | 71 Cases | 20 Cases | + |
| <i>S. salivarius</i> | + | ± | + | + | ± | . | . | . | . | ± | Brevis | 26 ⁽¹⁾ Cases | 7 ⁽¹⁾ Cases | . |
| <i>S. anginosus</i> | + | ± | + | + | . | . | . | . | . | ± | Longus | 16 Cases | 38 ⁽²⁾ Cases | + |
| <i>S. faecalis</i> - | + | + | + | + | . | . | + | + | + | + | Brevis | 13 Cases | 3 Cases | . |
| Pneumococci | ± | . | + | + | + | ± | . | . | . | . | Brevis | 34 Cases | . | + |

[It is not pretended by the authors that this is a hard and fast classification, on the contrary, it is frankly admitted that one group fades insensibly into another: "we venture to believe that some such conception of the streptococci as we have set forth is preferable to the idea that they are all one kind or that they present a hopeless chaos" (Andrewes and Horder).]

3. Toxins.

1. Roger grew a streptococcus anaerobically in meat broth at 30° C. for 5 days and then filtered the culture through porcelain.

When inoculated into the veins of a rabbit in doses of 15–20 c.c. per kg. of body weight the filtrate caused diarrhoea and wasting and the animal died in 2 days. Rabbits inoculated with 5–12 c.c. of the filtrate and subsequently (15–30 days later) with a virulent culture died more quickly than control animals. On the other hand, if the filtrate were heated to 104° C. and then inoculated into the veins in doses of 5–30 c.c. it produced a certain degree of immunity. From this it must be assumed that the filtrate contained two substances, one, thermostable at 104° C. and precipitable by alcohol, which was toxic and predisposed to infection, the other, thermostable at 104° C. and possessing immunizing properties.

¹ Mostly terminal or chronic infections.

² Principally from cases of scarlet fever.

2. Marmorek sowed a *passage* organism of increased virulence on human-serum-broth and after incubating for 3 months filtered it through porcelain.

The filtrate inoculated in doses of 1 c.c. into a rabbit weighing 2 kg. killed the animal in 3 or 4 days. The virulence of the toxin was diminished by heating at 58° C.

Marmorek prepared another, more powerful, toxin by growing the organism in broth to which a little leucin and glycocoll and some guinea-pig leucocytes had been added.

3. Bonome and Bombicci are of opinion that the toxin of the streptococcus is an endotoxin.¹ By treating streptococci with 10 volumes of a 0.75 per cent. solution of potash, filtering and precipitating with a 1 per cent. aqueous solution of acetic acid, they obtained a product which was toxic for rabbits. Rabbits inoculated with gradually increasing doses of the filtrate acquired a slight degree of immunity against the organism used in the preparation of the toxin but not against any other strain.

Hæmolysin. (Streptocolysin.)

Marmorek observed that the streptococcus is capable of producing an hæmolysin in the tissues of living animals and in this way appeared to differ from all other organisms. He considered that all streptococci of human origin were hæmolytic, and adduced this opinion in further support of his reasons for regarding all such streptococci as identical.

[Schlesinger however has described streptococci, both pathogenic and non-pathogenic, which were not hæmolytic.] Besredka also has isolated strains of streptococci which not only did not produce hæmolysin *in vitro* but, and this is very uncommon, were non-hæmolytic *in vivo*. [Schottmüller observed the same fact and, as has already been pointed out, divides streptococci into three groups according to the extent of hæmolysis produced when grown on blood-agar (p. 599). Andrewes and Horder find that among the pathogenic streptococci examined by them those referable to their "*pyogenes*" and "*anginosus*" groups alone produce hæmolysis on blood-agar.]

Besredka has investigated the nature of the streptococcal hæmolysin.

Cultures in Marmorek's ascitic broth are powerfully hæmolytic but lose this property on being filtered through a Chamberland bougie. [Besredka, however, points out that the phenomenon of hæmolysis in unfiltered cultures is of only minor importance; most micro-organisms are more or less hæmolytic in artificial culture but, curiously enough, lose this property on filtration. In the case of a few streptococci, however, a specific hæmolysin (streptocolysin) is formed which is filtrable, and for the test of hæmolysis to be of value filtered cultures should be used.]

Preparation of streptocolysin.—Besredka recommends the following technique for the preparation of a powerful streptocolysin:

Inject a few drops of a 24-hour culture of a streptococcus in ascitic-broth beneath the skin of a rabbit. Next day, as soon as the animal is dead, ascertain that the red cells are dissolved, and then sow two or three drops of the heart's blood into a tube of pure rabbit-serum or equal parts of broth and horse-serum. Incubate for 24 hours, then add an equal volume of normal saline solution and filter through a Chamberland bougie.

The filtrate readily dissolves rabbit, human, guinea-pig and sheep red-cells and to a less extent those of the horse and bovine animal: it is most actively hæmolytic at 37° C. It is not toxic. Attempts to immunize animals with the object of preparing an anti-hæmolysin have failed.

At the temperature of the laboratory, streptocolysin deteriorates in a few

¹ Simon considers that there is both an endotoxin and an extra-cellular toxin.

days and is destroyed in about a fortnight at 15°–18° C. A temperature of 55° C. for 30 minutes has no effect, but exposure to this temperature for 10 hours or to 70° C. for 2 hours totally destroys its properties.

4. Vaccination.

(*a*) **With toxin.**—Attempts to immunize animals by inoculating them with heated cultures (even when cultures heated to 60° C. were used) have given no conclusive results (Marmorek, Schonkewitch).

Marmorek tried to immunize a horse by inoculating it with increasing doses of a toxin which he had prepared (*vide ante*) and which killed rabbits in doses of 1 c.c. A horse weighing 300 kg. was inoculated with 1260 grams of the toxin in 14 injections carried out over a period of 2 months. There was only a slight reaction and the serum proved to be of very little value.

(*β*) **With living cultures.**—This is the most certain and rapid method of immunization.

Rabbits.—Marmorek immunized rabbits by inoculating them first with old cultures then with increasing doses of virulent cultures.

The most satisfactory results were secured in those cases in which the animals were in the first instance inoculated beneath the skin of the ear with an organism sufficiently virulent to cause a severe erysipelas: some of the animals succumbed after the first inoculation. But even those animals which were satisfactorily vaccinated by this method were not immune to the inoculation of the highly virulent *passage* streptococci of which the lethal dose was 0·000,000,01 c.c. The serum of these rabbits while immunizing other rabbits against infection with the streptococcus which had been used for immunization, exhibited as might have been anticipated no prophylactic properties against a *passage* streptococcus.

Mironoff had similar results with rabbits treated first with sterilized cultures then with increasing doses of virulent cultures.

Gromakowski inoculated rabbits in the peritoneal cavity first with an old culture heated to 100° C. then with an old culture unheated (5–10 c.c.) and lastly with increasing doses (1–10 c.c.) of virulent cultures. The animals had fifteen inoculations, a fortnight intervening between each inoculation. In the end the rabbits were immune against an intra-peritoneal inoculation of 30 c.c. of a virulent culture.

Large animals.—Marmorek immunized an ass, an horse and a sheep by inoculating small doses of an extremely virulent streptococcus beneath the skin: as soon as the animal recovered it was re-inoculated with a larger dose. Each inoculation was followed by a marked reaction.

Horses.—Begin with an inoculation of 0·75–2 c.c. of a serum-broth culture of a virulent organism beneath the skin of the neck. (When large quantities of culture are required ascitic fluid or ass serum may be used instead of human blood-serum.) The animal reacts violently; the temperature reaches 40° C. and this rise is accompanied by the development of a firm oedema at the site of inoculation. To obtain an efficient serum it is essential that the animals should be made to react violently. When the animal has recovered completely re-inoculate it with a double dose (5 c.c. for example) of a virulent culture. In this way the animal can gradually be brought to tolerate doses of 40 c.c. or more.

Asses.—Asses are much more susceptible than horses and react very violently. In Marmorek's experience, a dose of 5 cg. of a culture of which the lethal dose for a rabbit is 1 mg. produces a very severe reaction. It is well to begin with less virulent cultures and to increase the doses very slowly.

[(*γ*) **Anti-scarlatinal vaccination.**—Gabritchewsky relying on the analogy which he says exists between strangles in horses and scarlatina in man proposed to immunize children against the latter with a vaccine.

[The vaccine consists of a broth culture of a streptococcus isolated from a case of scarlet

fever. The culture is sterilized at 60° C. and centrifuged: part of the supernatant fluid is then decanted until each cubic centimetre contains 0·005 gram of dried organisms.

[Three inoculations are given. The first, for children of 2–10 years, consists of 0·5 c.c. of the vaccine, the second of 0·75–1 c.c. and the third of 1·5–2 c.c.]

[Inoculation is followed by a slight local and general reaction: in some cases by a scarlatiniform eruption and sore throat. Gabritchewsky considers that the latter symptoms prove the specificity of the vaccine.]

[For various reasons, it is hardly likely that this method of vaccinating against scarlet fever will prove to be of any value.]

[(δ) **Vaccines in human streptococcal infections.**—Autogenous vaccines are now very generally used in the treatment of human streptococcal infections and with much success especially if the vaccine treatment be combined with the ordinary surgical procedures and with the use of a specifically immunized serum.]

[*Preparation of the vaccine.*—Agar tubes are sown with material from the lesion and incubated for 24 hours at 37° C. The growth is then scraped off with a slender glass rod and made into an emulsion with normal saline solution to which 0·5 per cent. carbolic acid has been added. The emulsion is then sterilized either by heating at 60° C. for half an hour or by placing it in the incubator for 24 hours at 37° C. The sterility must be tested by cultivation.]

[*Standardization.*—The emulsion is then standardized either by Wright's method (p. 381) or by means of a Thoma-Zeiss counting chamber. If the latter be employed it will be found convenient to use a dilute solution of Azur II containing 1 per cent. of commercial formalin (to precipitate the organisms) as the diluent—the dye stains the organisms and so renders them more distinct.]

[*Method of use.*—The vaccine should be inoculated at the earliest possible moment and while it is being prepared it is recommended that a dose (10×10^6) of stock vaccine—prepared from a mixture of streptococci of the variety which are known commonly to cause the same type of lesion—should be administered. The dose (10 to 100 millions) and the intervals between the inoculations will vary according to circumstances—"the more acute and the more generalized the lesion the smaller should be the dose introduced" (Girling Ball).]

[**Sensitized vaccines.**—Sensitized vaccines prepared according to Besredka's method (p. 382) have recently been introduced for the treatment of human streptococcal lesions with encouraging results. As in the case of non-sensitized vaccines an autogenous vaccine, i.e. a vaccine prepared from the lesion to be treated, must be used.]

5. Serum therapy.

[The serum therapy of streptococcal infections is highly unsatisfactory. It is now more than 14 years since Marmorek introduced his antistreptococcal serum and though it would appear in some cases that the success following the use of the serum has been very striking, in the vast majority of cases it is far otherwise.]

[The difficulties attending the preparation of an antistreptococcal serum are greatly enhanced by the fact that it is still unknown whether the organisms isolated from streptococcal infections are all identical or whether several different species of streptococci exist. Upon the solution of this question the whole problem of streptococcal serum therapy largely turns.]

[Marmorek regarded all streptococci as identical, and this view was shared by Neufeld, and until recently by Aronson also. These observers therefore prepared a *monovalent* serum using a single strain of streptococcus artificially]

increased in virulence by passage through animals. In the laboratory these serums give good results with all streptococci whatever their source provided that the virulence of the latter be first raised by passage. But as Besredka points out, a "passage" streptococcus—whose properties have been profoundly altered by artificial means—differs widely from an organism which has not been subjected to treatment and whose pathogenicity is that natural to it, and herein probably lies the explanation of the discrepancies between laboratory results with these serums and clinical experience.

[Other observers acting on the theory that there are a number of different streptococci have prepared *polyvalent serums*. These latter may be regarded as of two types: (1) serums, as for instance that of Tavel, prepared by immunizing animals with a number of strains from different clinical streptococcal infections but previously "exalted" by passage and (2) Besredka's serum which is also prepared with a number of different strains which however have not been increased in virulence previously to being used for immunization.]

A. Monovalent serums.

Marmorek's serum.—Marmorek was the first to prepare an antistreptococcal serum for therapeutic purposes.

Preparation of Marmorek's serum.—Marmorek obtains his serum from horses. The animals are immunized in the manner described above and should, in order to yield a potent serum, be inoculated with considerable doses of virulent cultures, each horse receiving at least 2 litres of culture administered in increasing doses over a period of 6–12 months. An interval of 4 weeks should elapse after the last inoculation before the horse is bled (*vide B. diphtheriæ* for the technique of the collection of serum).

Each inoculation of a living culture into a horse for purposes of immunization is followed by a period of reaction during which the blood is toxic but contains no streptococci. The two following experiments illustrate this. (1) A rabbit was inoculated with 2 c.c. of serum which was collected during a period of febrile reaction from an already highly immunized horse. The rabbit died in a week. (2) Serum taken from a horse in a less advanced stage of immunization and a fortnight after the temperature had become normal was found, when inoculated in doses of 0.5–1 c.c. into animals weighing 1400 grams, to kill rabbits in 5–10 days.

The serum ceases to be toxic, and is therapeutic 3 weeks after the last inoculation; its therapeutic properties are most pronounced at the end of the fourth week (Marmorek).

Properties of the serum.—Marmorek's serum exhibits curative, prophylactic and antitoxic properties when tested on rabbits. It is not bactericidal *in vitro* and has very feeble agglutinating properties.

Bactericidal properties.—Streptococci grow in the serum slowly and feebly as they do in normal horse-serum. Growth also takes place in a mixture of the serum and rabbit-serum as in a mixture of normal horse-serum and rabbit-serum and the virulence of the organism is unimpaired (Mironoff: Bordet).

Agglutination.—The property of agglutinating streptococci possessed by Marmorek's serum is very feeble and irregular. To a given volume of culture emulsion at least one-third of that amount of serum must be added (Bordet).

Antitoxic properties.—Using a toxin of which 1 c.c. is fatal to rabbits in 3 or 4 days it is found that if 3–5 c.c. of the serum be mixed with the fatal dose the mixture is harmless on inoculation into a rabbit.

Prophylactic properties.—If a rabbit be inoculated under the skin with 2 c.c. of the serum and 24 hours later with 0.000,001 c.c. of a culture which will kill a control animal in a dose of 0.000,000,1 c.c. the animal survives the inoculation. A dose of serum equivalent to $\frac{1}{7000}$ th of the weight of an animal protects it against infection.

Curative properties.—1 c.c. of the serum will save the life of a rabbit inoculated 3 hours previously with 10 times the lethal dose of an exalted (*passage*) virus: 5 c.c. will in like manner cure rabbits inoculated 5 hours previously: but in the case of animals inoculated with the virus 6 hours before the administration of the serum, the latter is powerless to prevent infection. When an organism of ordinary virulence for the lower animals is used as the test [streptococci taken direct from human lesions are sometimes non-virulent for animals], inoculation of serum even 24 or 30 hours later leads to the recovery of the animal.

According to Behring and Knorr, Marmorek, Aronson and others, if an animal be immunized against one strain of streptococcus it is equally immunized against related strains and the serum is efficient in both cases. This opinion would, however, not seem to be justified by clinical experience: thus, Méry was unable with Marmorek's serum to immunize rabbits against a streptococcus isolated from the blood of a case of scarlet fever (*vide infra*) and Courmont has proved that a serum prepared according to Marmorek's directions is only effective against the strain used for its preparation and not against strains from other sources.

Use of Marmorek's serum in practice.—Marmorek's serum has been used in cases of streptococcal infections in man but without any striking result.

In cases of *erysipelas* and *puerperal septicæmia* the results have not come up to expectation. The serum is generally inoculated in doses of 10 c.c. repeated, if necessary, daily for a week or more: in serious cases 20 c.c. has been the initial dose.

In *scarlet fever*, Marmorek's serum has yielded encouraging but not conclusive results. [It is conceivable that these results were obtained in those cases—which are very common—in which the streptococci were associated as a secondary infection.]

In cases of *faucial diphtheria* in which streptococci are present as a secondary infection, Roux has tried mixing antidiphtheria serum with the serum of rabbits immunized by Marchoux against streptococci: the results were not successful. Martin used Marmorek's horse-serum in combination with antidiphtheria serum and obtained rather more satisfactory results.

In the disease known as *anasarca* of the horse, caused by a streptococcus similar to those found in man, Marmorek's serum has given good results (Nocard and others) and has lowered the death-rate considerably.

Aronson's serum.—Like Marmorek, Aronson regarded all streptococci occurring in human disease processes as belonging to one and the same species. His investigations were carried out on 17 strains of streptococci.

Preparation of the serum.—Aronson increased the virulence of the organism by passing it through a number of mice. In this way a streptococcus was obtained which would kill mice in a dose of 0.000,000,01 c.c. of a glucose-broth culture. Horses were then immunized with increasing doses of this passage virus.

The serum of these animals is **prophylactic** in the case of mice against streptococci of human origin *provided always that the virulence has been raised by passing it through mice*. It does not protect mice against the streptococcus of strangles (Chap. XLII.) when first isolated from the horse but is very efficient against that organism when it has been passed through several mice.¹

The prophylactic properties of Aronson's serum are shown by the fact that if 0.0002 c.c. be inoculated into the peritoneal cavity of a mouse and 24 hours later one hundred fatal doses of a *passage* virus be inoculated, the mouse survives.

Aronson's serum also possesses **curative properties**.

Thus, if inoculated 7 hours after an intra-peritoneal inoculation of the virus the animal recovers, and even if the administration of the serum be delayed for 24 hours it still leads to recovery in 50 per cent. of the animals.

¹ Marmorek's serum has very little effect on a virus which has been passed through mice.

Agglutination.—Aronson's serum has considerable agglutinating properties for most streptococci. Some cultures are agglutinated in a dilution of 1 in 20,000.

[More recently Aronson, in immunizing horses, has used in addition to his *passage* organism a number of other streptococci which have not been passed through animals.]

Moser's serum.—With a view to the preparation of an antiscarlatinal serum Moser used a number of streptococci isolated from cases of scarlet fever. He immunized horses by repeatedly inoculating them with living cultures obtained by sowing broth with blood from persons suffering from scarlet fever. No attempt was made to increase the virulence of the organism by passage before using it for immunization.

Moser's serum agglutinated streptococci isolated from cases of scarlet fever. In the laboratory it has some action, though feeble and inconstant, on streptococci which have been passed through mice (Sommerfeld).

In the treatment of scarlet fever opinions differ as to its value. According to some observers it has a very beneficial action on the streptococcal infections of the disease (Moser; Paltauf; Pospischill). Others unfortunately have failed to secure these beneficial results (Moltchanoff, Baginski, Czerny) and as a therapeutic agent it is now practically discarded. There is "nothing, from the biological point of view, to justify the specificity of such a serum" (Besredka) and it has already been said above that in scarlet fever the streptococcus is merely a secondary, associated, infection.

[**Andrewes and Horder's serum.**—Seeing that in their experience the *Streptococcus pyogenes* as defined by them (*vide ante*) is the commonest variety in human streptococcal lesions, Andrewes and Horder prepare a specific monovalent antipyogenes serum by using for the inoculation of horses strains of their *Streptococcus pyogenes*. This serum seems to give much more satisfactory results than any other antistreptococcal serum of which they have had experience (Andrewes).

[The most beneficial results are obtained in practice by using the serum in conjunction with autogenous vaccines as adjuvants to the ordinary surgical procedures. Thus in puerperal cases—in which the serum has been more extensively used than in any other class of streptococcal infection—if the temperature should rise above normal, a dose (50 c.c.) of the serum is administered there and then and a swab taken from the interior of the uterus. The uterus is then douched. Twenty-four hours later a small dose (5 to 10 millions) of a vaccine prepared from the organism, usually *S. pyogenes*, grown from the swab is given, followed later by other doses of the vaccine. Cases treated thus at the first sign of infection almost invariably do well and do not pass on to septicæmia (Andrewes). The secret of success lies in commencing the treatment during the earliest stages of infection and before the organism has passed beyond the uterine cavity.

[A like procedure has been followed in other forms of streptococcal infections—appendicitis, cellulitis, arthritis, etc.—with distinctly encouraging results (Girling Ball).

[In streptococcal infections caused by varieties of streptococci other than *S. pyogenes* similar treatment should be adopted and in infective endocarditis the use of a specifically immunized serum combined with an autogenous vaccine offers the best hope of recovery (Horder). It seems quite likely as suggested by Horder that the combination of a specifically immunized serum and an autogenous vaccine acts in a similar way to the "sensitized vaccines" of Besredka.]

B. Polyvalent serums.

Convinced of the multiplicity of streptococci and noting the failure of Marmorek's serum in clinical practice, various authors (Denys, Van de Velde, Tavel) have prepared, by inoculating animals with emulsions of different

strains of streptococci, *polyvalent serums* which they hoped would be effective against these different viruses. The results however have been disappointing.

Tavel's serum is prepared in a manner similar to that adopted by Marmorek but *passage* streptococci from various sources are used for inoculation. This serum is said to be only prophylactic.

Besredka's serum.—This is the anti-streptococcal serum now prepared at the Pasteur Institute in Paris.

For the preparation of the serum, Besredka uses streptococci kept in a medium consisting of equal parts of Martin's broth and horse serum heated to 56° C. for half-an-hour.

In order to obtain a large quantity of growth for purposes of inoculation the medium used is agar contained in Roux bottles (p. 78) which is watered with about 1 c.c. of horse serum before sowing the cultures. An abundant growth is obtained in 24 hours and this is scraped off and made into an emulsion with normal saline solution.

Horses are immunized by intra-venous inoculation, each inoculation being made with six to eight different strains of streptococci isolated from human lesions to which, for purposes of standardization, a streptococcus virulent for mice or rabbits is added. The streptococci are not passed through animals. The immunizing process is rather tricky, each inoculation being marked by a sharp temperature reaction lasting about 48 hours. Occasionally articular symptoms and inflammatory phenomena develop 10 days to a fortnight after the inoculation: these symptoms however rarely terminate fatally.

The serum is not bactericidal but has considerable prophylactic and curative properties. For example a mouse inoculated sub-cutaneously with ten times the fatal dose of streptococci can be saved by an injection 18–24 hours later of 0·001 c.c. of the serum into the peritoneal cavity. Under similar conditions the dose for a rabbit is 1·5–2 c.c.

The therapeutic value of the serum in human infections is still *sub judice*.

6. Agglutination.

Attention has already been directed to the agglutinating properties of the different serums, and from what has been said it will be gathered that this property is very inconstant. It not infrequently happens that a strain other than that used for the preparation of a serum is more powerfully agglutinated than that used for immunization.

In culture, streptococci grow together and form large granular masses so that for agglutination tests an homogeneous emulsion must be prepared.

The serum of persons suffering from streptococcal infections has no agglutinating capacity for streptococci.

7. Bordet-Gengou reaction.

[Besredka expresses the opinion that it may be possible by means of the Bordet-Gengou reaction to establish a natural classification of the streptococci. In some experiments carried out with Dopter he found that three streptococci from very different sources all had a common *fixateur*: one of these streptococci was recovered from a child who had died of septicæmia another from a case of erysipelas and the third from a child who had died of scarlet fever. On the other hand he several times found that two streptococci both isolated from the blood of the heart of a case of scarlet fever reacted differently to the same *fixateur*.]

SECTION IV.—THE DETECTION AND ISOLATION OF STREPTOCOCCI.

(a) **Microscopical examination.**—A number of films should be prepared with the material (pus, blood, serous fluid, etc.) and stained, some with carbol-thionin [or dilute carbol-fuchsin] and others by Gram's method.

Tissues for sections (erysipelas skin, internal organs, etc.) should be fixed

in acid perchloride or absolute alcohol and subsequently stained by Gram's method (double or triple staining, p. 219).

(b) **Cultures.**—*Blood* should be sown in broth and on agar.

Pus.—To isolate streptococci from pus when other organisms are present, sow a little of the material on three agar-slope tubes by the dilution method (p. 82). In this way single colonies will be obtained.

To isolate streptococci from a case of erysipelas: cleanse the skin, make a prick with a lancet, and wipe away the first drop or two of blood with a piece of sterile filter paper, then with the thumb and index finger pinch up the skin on either side of the puncture, collect the fluid which wells up in a Pasteur pipette and sow it in broth.

(c) **Animal inoculation.**—To determine the virulence of a streptococcus either inoculate the material containing the organism directly into a rabbit; or, better, make a preliminary culture in broth or blood-broth, incubate at 37° C. for 2 days and then inoculate a rabbit.

[Mice may, of course, be used instead of and are, in many ways, more convenient than rabbits.]

Meyer and Ruppel sowed material containing streptococci direct from various human diseases (erysipelas, scarlet fever, inflammatory conditions, etc.) on to defibrinated human blood and obtained cultures which were from the first virulent for rabbits and mice: 0.01–0.000,001 c.c. of these cultures was fatal to mice on intra-peritoneal inoculation.

Streptococcus of Bonome.

Bonome isolated a streptococcus from the pus of cases of cerebro-spinal meningitis and the same organism has since been found by Netter, Chantemesse, Bezançon and Griffon in many cases of epidemic meningitis. This streptococcus apparently plays merely the part of a secondary infection in epidemic meningitis and indeed has frequently been found associated with the meningococcus.

According to Netter this organism is an attenuated variety of the pneumococcus: well-marked differences however exist between the two organisms. The *streptococcus meningitidis* appears to be very closely related to the *streptococcus mucosus* of Schottmüller.

Experimental inoculation.—White mice are very susceptible; after sub-cutaneous inoculation they die in 24 hours of septicæmia. Rabbits are rather less susceptible and guinea-pigs are as a rule refractory to sub-cutaneous inoculation. Intra-pleural inoculation is fatal to white rats. After several *passages* through rats the organism no longer forms chains but has the morphological appearance of the pneumococcus (Netter).

Microscopical appearance.—The streptococcus of Bonome is an ovoid coccus which forms short chains generally seen extra-cellularly and which in pus and serum cultures shows a capsule.

It is readily stained by the aniline dyes and is *gram-positive*.

Cultures.—This streptococcus grows easily on the ordinary media. Growth takes place at 20° C. and consequently the organism can be grown on gelatin. The optimum temperature is 37° C.–38° C. The vitality of the streptococcus of Bonome is greater than that of the pneumococcus (Bezançon and Griffon).

Broth.—Sown in broth and incubated at 37° C. the streptococcus of Bonome gives rise to a slight cloudiness in 24 hours and later to a minimal deposit.

Gelatin.—On gelatin at 22° C. the organism gives rise to a scanty growth of small white opaque discrete points. The medium is not liquefied.

Agar.—A delicate growth of transparent colonies similar to those of the pneumococcus is formed on agar on incubation at 37° C.

Liquid rabbit serum.—The culture on this medium is characteristic (Bezançon and Griffon). After 24 hours' incubation at 37° C. there is a very slight cloudiness of the medium and a little deposit. Under the microscope it will be found that the growth consists of chains of variable length and of diplococci *agglutinated* in small clumps. The capsules are delicate and shrivelled.

Milk.—Growth takes place and the medium is sometimes coagulated but often unchanged.

Potato.—No apparent growth on potato.

CHAPTER XLII.

STREPTOCOCCI ANIMALIUM.

- I, *Streptococcus equi*.
- II, *Streptococcus mammitis bovis*, p. 613.
- III, *Micrococcus mammitis of ewes*, p. 615.

I. *Streptococcus equi*.

(*The streptococcus of strangles.*)

STRANGLES in horses is caused by a streptococcus discovered by Schütz, which is found also in a number of other though very different clinical conditions in the horse. This organism has been confused with the equine pasteurella which, as a matter of fact, prepares the way for the streptococcus of Schütz.

It has been pointed out already (Chap. XXVIII.) that in a large number of conditions originated by members of the pasteurella group the original infecting agent disappears early in the course of the disease, so that bacteriological examination reveals only the presence of the secondary or associated infection, in this case the streptococcus.

Strangles is chiefly a disease of young horses from 1-5 years old. The common symptoms are:—nasal catarrh, swelling and suppuration of the glands in the sub-maxillary space (*strangles*) and lymphangitis. The lungs and pleuræ are not infrequently involved and the pleurisy may be of the purulent variety. Sometimes the disease may become generalized, in that case there is septicæmia with metastatic abscesses. The streptococcus can be found in the discharge from the nose, in the enlarged glands, in the abscesses, in the pus from the pleura, in the pulmonary lesions, etc.

The *streptococcus equi* though differing from them in certain respects is very closely related to the *streptococci hominis*. It grows well in the filtrate of a broth culture of the *streptococci hominis* (p. 598). Marmorek's serum has no action upon it.

SECTION I.—EXPERIMENTAL INOCULATION.

White mice.—White mice are the animals most susceptible to experimental infection. After subcutaneous inoculation an abscess forms at the site of inoculation: this is followed by lymphangitis and enlargement of the related glands, and as in the horse, the lungs and pleuræ may become involved and abscesses may form in the internal organs. The streptococcus is found in pure culture in all the lesions: in the blood it only occurs in

small numbers, so that cultivation experiments are necessary to demonstrate its presence. A very highly virulent strain will cause a fatal septicæmia with only slight œdema at the site of inoculation.

Horses.—The disease may also be produced experimentally in the horse. Sub-cutaneous inoculation leads to the formation of an abscess. By rubbing the nasal fossæ with a plug of wool soaked in a culture, a clinical condition similar to the spontaneous disease is produced (Schütz and others). Intra-venous inoculation is followed by an interesting result: it leads merely to a transitory illness but appears to produce immunity (Sand and Jensen). [An abscess forms at the site of inoculation which discharges externally.]

Mules, and more particularly **asses**, are less susceptible to the disease than horses.

Rabbits are even more highly immune and to produce an infection in these animals the material must be inoculated intra-venously. In that case death takes place from septicæmia.

Guinea-pigs are almost completely immune though it is possible to set up a fatal infection by inoculating large quantities of a virulent virus into the peritoneal cavity.

Material for inoculation.—For purposes of experimental inoculation a young growth of the first sub-culture in broth, or pus from an abscess should be used.

SECTION II.—MORPHOLOGY.

1. Microscopical appearance.

The micro-organism of strangles is a coccus generally arranged in chains or diplococci, only rarely as isolated cocci; the chains may be short consisting of three or four cocci only, or long and wavy and made up of a large number of cocci. The individual cocci measure 0.7–0.9 μ in diameter but oval-shaped cocci with their long axes transverse to the length of the chain are often seen. Encapsulated cocci are not infrequently present in stained films from serum cultures. A distinct capsule has been seen surrounding the cocci in films made with pus from the pleura in a case of strangles (Besson).

Staining reactions.—The *streptococcus equi* stains easily with the basic aniline dyes—Kühne's blue or carbol-thionin. The organism is gram-positive. Pus from a case of strangles gives very pretty preparations when treated with Gram's stain and counter-stained.

2. Cultural characteristics.

Conditions of growth.—The streptococcus of strangles is an aerobic and facultative anaerobic organism: it grows best at 37° C. and only poorly below 20° C. According to Schütz it only grows in broth or on serum; scanty growths can at times be obtained on agar and gelatin (Nocard, Sand and Jensen).

Characters of growth. Broth.—Glycerin-broth is the best medium. The organism grows like the streptococcus of erysipelas and forms small white flocculi which quickly fall to the bottom of the vessel leaving the medium clear.

Agar.—Cultures have been obtained on sloped agar (Nocard, Sand and Jensen). The growth is more luxuriant if sown in deep stab culture.

Besson had a strain which grew fairly well on sloped agar for two or three generations; the colonies were semi-transparent and lenticular-shaped but never exceeded in size that of a pin's head.

Gelatin.—Schütz and Poels failed to grow the organism in stroke culture; Sand and Jensen succeeded in obtaining cultures both on the surface and in stab culture, but the former were very scanty indeed.

With the strain mentioned above Besson secured a distinct growth on the surface of gelatin at 22° C.; the colonies were discrete and transparent, and numbered about ten. A sub-culture sown on gelatin on the eighth day failed to grow.

Potato.—No apparent growth takes place on this medium.

Serum.—On sloped serum the growth is fairly abundant. Small, semi-transparent, lenticular colonies at first appear; these soon become confluent and form a rather thick, grey, iridescent layer. The streptococci often show a very distinct capsule on microscopical examination.

Milk.—The streptococcus coagulates milk in 6–8 days.

SECTION III.—BIOLOGICAL PROPERTIES.

Viability.—The streptococcus of strangles is a very delicate organism.

Besson found that a very actively growing culture in broth was dead in 12 days. When sown from agar on to agar or from gelatin on to gelatin, sub-cultures almost always fail. With an organism which grew well when first sown on agar from broth, Besson obtained a scanty growth on the second sub-culture on agar but practically none on the third.

Immunity.—The immunity resulting from an attack of the naturally acquired disease is of very short duration. Sand and Jensen succeeded in immunizing a horse by inoculating it intra-venously with a virulent culture and the animal subsequently proved to be immune to intra-nasal inoculation.

The antistreptococcal serum of Aronson has proved effective as a prophylactic in experiments with the streptococcus of Schütz, provided that the latter had undergone several passages through mice: it is however totally ineffective in the case of an organism obtained direct from the horse (Aronson).

II. *Streptococcus mammitis bovis*.

(*Contagious mammitis of cows*.)

Contagious mammitis of milch cows is due to an infection with streptococci (Nocard and Mollereau): the organism may be found in very large numbers in the milk of the affected beasts.

The disease is characterized by the formation in the gland of an indurated nodule, which may attain the size of the fist and even invade the whole organ. The disease runs a chronic course and does not endanger the life of the animal: it is spread by the conveyance of the specific organism from one cow to another on the hands of the milker.

The milk shows the following characteristic changes. Microscopically it is seen to contain pus cells and numerous chains of cocci. The reaction is occasionally acid. Sometimes the milk is normal in appearance at the time of milking, but it rapidly turns acid and coagulates. If collected aseptically in sterile tubes (p. 201) and kept at room temperature the milk soon turns acid and clots while the streptococci increase in number.

SECTION I.—EXPERIMENTAL INOCULATION.

The inoculation of a few drops of a young culture or of some infected milk into the teats of cows or goats produces a mammitis with all the features of the spontaneous disease. Laboratory animals are not susceptible.

SECTION II.—MORPHOLOGY.

1. Microscopical appearance.

The infecting organism in this disease is a coccus about 1μ in diameter, round or somewhat oval and arranged in chains. In cultures the chains are very long, often extending beyond the field of the microscope, while in milk and in the affected tissues they are distinctly shorter.

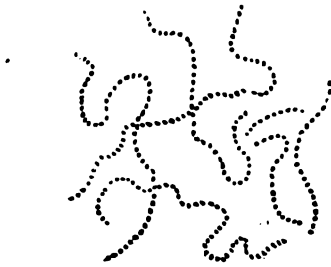

FIG. 287.—*Streptococcus mammitis bovis*.
Film from a broth culture. Carbol-thionin.
(Oc. II, obj. $\frac{1}{3}$ th, Reich.)



FIG. 288.—*Streptococcus mammitis bovis*.
Film from the milk of an infected cow.

Staining reactions.—The *streptococcus mammitis* stains well with the basic aniline dyes: it stains badly by Gram's method and is easily decolourized. Films prepared with milk or cultures should be stained with carbol-thionin or carbol-blue.

Sections of the gland are best stained with carbol-blue and tannin (p. 217).

2. Cultural characteristics.

Conditions of growth.—The streptococcus is indifferently aerobic; the ordinary media are quite suitable if slightly modified; the optimum temperature is from 35° – 37° C. and growth also takes place at room temperature.

Characters of growth. Milk.—The organism grows well in milk which it turns acid and coagulates in about 34 hours.

Broth.—The most suitable broth is meat extract (p. 32) containing 2–4 per cent. of glucose or lactose. Incubated in this medium at 37° C. the streptococcus rapidly forms a small whitish deposit sometimes flocculent and consisting of long chains of cocci. When left undisturbed the medium remains clear but becomes cloudy if gently shaken.

The broth soon becomes very markedly acid and this stops further growth. A richer culture and one which lives longer is obtained by adding 2 per cent. calcium carbonate (p. 35) to the broth. Although the organism dies in a few weeks in ordinary media it lives several months in media containing calcium carbonate.

Gelatin. Stab culture.—After 3 or 4 days small, whitish, opaque, rounded colonies appear, these then run together and form a thick line of growth. The gelatin is never liquefied.

Stroke culture.—Small, rounded, translucent colonies are formed which coalesce to form a pellicle thicker at the edges than in the centre.

Agar. Serum.—On these media the stroke cultures have the same characteristics as on gelatin but the growth is more scanty.

Potato.—The organism either fails to grow altogether or produces a barely visible film.

III. *Micrococcus mammitis*.¹*(The coccus of gangrenous mammitis in ewes.)*

Nocard has proved that gangrenous mammitis in milking ewes is due to a coccus which has no tendency to form chains.

Bridré believes that this organism is a normal inhabitant of the udder of milking ewes and that mammitis only occurs when through some internal lesion of the gland the organism can penetrate into its tissues.

Mammitis in ewes is usually fatal in 24–48 hours. The mammary gland is hot, red, painful and hard; the lesion then extends into the sub-cutaneous cellular tissue of the thighs and trunk, while the skin becomes infiltrated with a serous œdema and has an erysipelatous appearance; later the affected parts become gangrenous and the animal dies. The coccus is present in large numbers in the milk, in the mammary gland, and in the blood-stained fluid in the sub-cutaneous cellular tissue and peritoneal cavity. The infection may perhaps be carried by the milker's hands: Nocard certainly failed to cause infection by painting the teats of healthy ewes with a virulent culture, but the injection of a few drops of the same culture into the milk ducts resulted in infection even though the mucous membrane was intact.

SECTION I.—EXPERIMENTAL INOCULATION.

Ewes readily contract the disease if a few drops of infected milk or of a 24-hour culture of the coccus be injected into the teats or substance of the gland.

Goats and laboratory animals are not susceptible. In rabbits an abscess forms at the site of inoculation and the animals recover.

SECTION II.—MORPHOLOGY.**1. Microscopical appearance.**

The micro-organism of the mammitis of ewes is a very small coccus measuring about 0.2μ in diameter. The cocci are arranged in pairs, in tetrads or in small clumps. They stain very well with the basic aniline dyes and can be seen but with difficulty in unstained preparations. They are gram-positive.

2. Cultural characteristics.

Conditions of growth.—The coccus of Nocard is indifferently aerobic. It grows in the ordinary neutral or alkaline media. The optimum temperature lies between 35° and 39° C. but it will grow at the ordinary temperature of the room.

To preserve its virulence sub-cultures should be re-sown daily.

Like the *Streptococcus mammitis* of cows, Nocard's coccus remains alive longer in broth containing calcium carbonate than in ordinary broth.

Characters of growth. Milk.—The medium becomes strongly acid and is coagulated in 24 hours.

Broth.—Ordinary broth or glucose broth become very markedly turbid and a large white precipitate is deposited. A considerable amount of acid is formed.

Gelatin. Stab cultures.—The coccus grows rapidly at 20° C. Liquefaction commences after the second day and is conical below but the upper layers are completely liquefied and turbid.

¹ For convenience of reference the organism causing mammitis in ewes will be considered here, though morphologically the infecting agent is distinct from that of the mammitis of milch cows.

Agar.—On agar slopes a thick spreading growth is formed which is at first white and then somewhat yellowish.

Potato.—On potato growth is always poor. A greyish, scalloped film forms which slowly acquires a yellowish tint.

SECTION III.—VACCINATION.

Bridré vaccinated ewes by giving them two inoculations on each side of the abdomen of 0·5 c.c. of a broth culture attenuated by keeping it in the hot incubator (37° C.) for 3 or 4 months. A small abscess or slough often formed at the site of inoculation; the animals were immunized in about a fortnight.

Bridré has shown that the serum of hyper-immunized sheep has prophylactic properties.

CHAPTER XLIII.

STAPHYLOCOCCI PYOGENETES.

Introduction.

Section I.—The experimental disease, p. 618.

Section II.—Morphology, p. 619.

1. Microscopical appearance and staining reactions, p. 619. 2. Cultural characteristics, p. 619. *Staphylococcus pyogenes aureus*, p. 619. *S. pyogenes albus*, p. 620. *S. pyogenes citreus*, p. 620.

Section III.—Biological properties, p. 620.

1. Vitality and virulence, p. 620. 2. Bio-chemical reactions, p. 621. 3. Toxin, p. 622. 4. Vaccination, p. 623. 5. Serum therapy, p. 624. 6. Agglutination, p. 624.

Section IV.—Detection and isolation of the staphylococci, p. 625.

Diplococcus crassus, p. 626.

SINCE the discovery by Pasteur of the *Staphylococcus aureus* two other pyogenic staphylococci have been described, namely the *Staphylococcus pyogenes albus* and the *Staphylococcus pyogenes citreus*. In their biological properties these three micro-organisms are similar, differing from one another only in the colour of their growths. Rodet and Courmont regard them merely as three races of the same species and this view is probably correct. The three organisms will therefore be described together: the *Staphylococcus aureus* will be taken as the type and the characteristics by which the other two varieties are differentiated from it will be noted in the proper places.

The pyogenic staphylococci are very widely distributed in nature, and are found in the air and sometimes in water, and in man on the skin and mucous membranes, under the finger nails, and in the alimentary canal.

Staphylococci are always present in the mouth: the organisms found in this situation and described by Biondi as *Micrococcus salivarius pyogenes*, *albus* and *aureus*, are identical with the *Staphylococcus albus* and *aureus* respectively.

In human pathological lesions they are frequently found in pus, especially in furunculosis, osteo-myelitis (Pasteur), abscesses in various parts of the body, etc. Occasionally the staphylococcus enters the blood stream giving rise to a purulent infection known as pyæmia.

The pyogenic staphylococci are found in the lesions of suppurative pleurisy, pericarditis and peritonitis, and also in ulcerative endocarditis: they are the cause of some cases of broncho-pneumonia, of inflammatory conditions of the throat, bronchitis, coryza, etc. They are frequently associated with the tubercle bacillus in pleurisy and suppurative meningitis: they complicate infections with the trichophyton parasites, and are often associated with the pneumococcus in pneumonia and with the diphtheria bacillus in diphtheria: they favour the germination of the spores of the bacillus of malignant œdema (Besson), of the bacillus of hospital gangrene (Vincent), of the bacillus of influenza (Grassberger), and of some other organisms.

Staphylococci are found in a very large number of the suppurative conditions occurring in the mammalia and birds. The *Staphylococcus aureus* is the infecting agent of an osteo-myelitis occurring in young geese (Lucoet). The organism can even develop in fish and was the cause of an epizootic which broke out among the gudgeon in the Rhone (Charrin).

SECTION I.—THE EXPERIMENTAL DISEASE.

Among the very numerous staphylococci which can be readily isolated from the circumambient media as well as from the various suppurations occurring in the human body it is but rarely that a very virulent organism is found; in the great majority of cases staphylococci isolated from these sources are either very slightly virulent or totally avirulent.

In the human subject.—Garré produced boils by rubbing the skin energetically with a piece of wool soaked in a culture of *Staphylococcus aureus*.

Rabbits.—The rabbit is the best animal for purposes of experimental inoculation.

Sub-cutaneous inoculation.—The sub-cutaneous inoculation of a few drops of a virulent culture produces an abscess and at the same time a rise of temperature; then the abscess points and discharges and the animal is well again, but on rare occasions the organism may infect the blood stream with fatal results.

Muscatello and Ottaviano using a virulent culture of the staphylococcus on serumbroth produced a rapidly fatal result in rabbits with general dissemination of the micro-organism after sub-cutaneous inoculation. No metastatic abscesses were formed but the internal organs and especially the spleen showed lesions of necrosis.

According to these observers, if a culture of a very virulent strain be inoculated death takes place from toxæmia before the organism has had time to become generalized through the tissues.

Intra-peritoneal inoculation.—Intra-peritoneal inoculation is more severe than sub-cutaneous inoculation: it leads to a rapidly fatal septic peritonitis. Passage through rabbits increases the virulence of strains of staphylococci, and the organism can be found in the blood and internal organs of animals that die.

Intra-pleural and intra-articular inoculation.—Inoculation into the pleural cavity or into a joint leads to a purulent effusion into the cavity, and the animal succumbs in a few days. If the strain be very virulent it rapidly produces septicæmia followed by death in 24–48 hours.

Intra-venous inoculation.—Inoculation of a staphylococcus into the veins is as a rule followed by grave complications. In severe cases the organism rapidly invades the tissues and sets up a condition of pyæmia with septic foci in the internal organs and especially in the kidneys. Death takes place in 48 hours or more. With a culture of increased virulence, death supervenes more quickly; no metastatic abscesses are formed but the internal organs show areas of necrosis. Staphylococci are found in masses in the lumens of the uriniferous tubules of the kidney: after the second day no micro-organisms can be found in the blood (Muscatello and Ottaviano).

In some cases, especially if lesions be artificially produced in the heart beforehand, inoculation determines fatal ulcerative or vegetative endocarditis (Wysokowitch, Ribbert, Bonome).

Rodet and Lannelongue reproduced the lesions of osteo-myelitis by intravenous inoculation. This can very easily be done if a bone be traumatized before inoculation. In the rabbit it is possible to produce an inflammation at the junction of the bone and epiphysis similar to that occurring in the human subject.

If the staphylococcus be only slightly virulent or the dose injected be small, a suppurative arthritis is produced which may either prove fatal or end in recovery (Courmont). Bezançon and Griffon described a staphylococcus which invariably produced articular lesions.

Occasionally death does not take place for a long time: in such cases lesions of myelitis will be found and the animal will suffer from paralysis and convulsions.

Guinea-pigs, Rats, Mice and Dogs.—These animals are not so constantly susceptible as rabbits. In them, sub-cutaneous inoculation produces an abscess; intra-peritoneal inoculation may terminate in a fatal septicæmia.

Geese.—Lucet, by inoculating staphylococci isolated from a case of the peculiar osteo-myelitis of young geese, was able to reproduce the characteristic lesions of the disease in geese. Feeding experiments and sub-cutaneous inoculation were without result, but inoculation of broth cultures or of pus from the bone into the vein of the wing proved fatal in 3–4 days. *Post mortem*, a multiple osteo-myelitis was found, and the liver was very much enlarged: the organism was isolated from the bone marrow, the pus in the bone, and from the spleen.

SECTION II.—MORPHOLOGY.

1. Microscopical appearance.

The staphylococci are spherical cocci measuring 0.6–1 μ in diameter, non-motile, generally arranged in irregular-shaped masses of five to thirty cocci which are often compared to bunches of grapes, and rarely occurring singly or in pairs or in short chains composed of quite a few cocci.

Staining methods.—The staphylococci stain readily with the basic aniline dyes and are gram-positive.

These characteristics are common to all varieties of the pyogenic staphylococci.

2. Cultural characteristics.

Physical conditions.—The staphylococci grow at any temperature between 10° and 44° C., on all culture media, aërobically as well as anaërobically: the optimum temperature is about 35–37° C. The most favourable temperature for pigment production lies between 20° and 25° C.; the colour does not appear when the cultures are grown *in vacuo*.

Staphylococcus pyogenes aureus.

Broth.—At 37° C. the medium becomes cloudy in 12–24 hours, after which an abundant white precipitate is thrown down but the broth still remains cloudy. Later on, the precipitate assumes a yellowish tint and may become bright orange in colour. Sometimes the pigment is slow in making its appearance and may never be very marked. In old cultures, the *Staphylococcus aureus* often loses its power of producing pigment and then cannot be distinguished from the *Staphylococcus albus*.

Gelatin. Stab culture.—At 20° C. in 24–36 hours a granular growth appears along the line of sowing: towards the fifth day it forms a funnel-shaped liquefaction filled with a turbid liquid and at the bottom a yellowish-white



FIG. 289.—*Staphylococcus pyogenes aureus*. Film from a broth culture. Carbol-crystal-violet. (Oc. III, obj. 1/4th, Reich.)

precipitate: the funnel of liquefaction subsequently enlarges and reaches the sides of the tube and little by little becomes cylindrical, but it rarely extends to the bottom of the tube. Some strains of the *Staphylococcus aureus* liquefy gelatin much more slowly than others. One of these strains which in every other respect resembled the *Staphylococcus aureus* did not commence to liquefy gelatin until it had been incubated at 20° C. for a fortnight, and even then the liquefaction was always minimal in amount (Besson).



FIG. 290.—*Staphylococcus pyogenes aureus*. Deep stab culture in gelatin.

Single colonies.—After incubating for 2–4 days at 20° C. small greyish circular colonies with a yellow centre appear: a little later an annular liquefaction occurs around these colonies, which extends more or less rapidly. Yellow flakes can be seen swimming in the cloudy liquid.

Agar. Coagulated serum.—At 37° C. numerous white rounded colonies appear in 24 hours along the line of inoculation; these rapidly coalesce to form a more or less shiny moist broad band, and the growth soon acquires a colour varying between a dirty yellow and a bright orange yellow. Sometimes the colour does not appear until about the eighth or tenth day.

Potato.—It is on this medium that the *Staphylococcus aureus* produces the most intense colour. Towards the second or fourth day at 37° C. the growth forms a more or less bright yellow thick layer.

Milk.—Growth rapidly leads to coagulation of the medium.



FIG. 291.—*Staphylococcus pyogenes aureus*. Surface colony on a gelatin plate (5 days). $\times 10$.

Staphylococcus pyogenes albus.

This organism has the same characteristics as the *Staphylococcus aureus* except that the growths are always white. On agar the colour is dull white like porcelain. It often liquefies gelatin more slowly than the *Staphylococcus aureus* [and Gordon has shown that some strains fail to liquefy gelatin. The larger number of the strains examined by Gordon did not clot milk].

Staphylococcus pyogenes citreus.

Here again, the characteristics are the same as those of the *Staphylococcus aureus* save that the colour of the cultures is a citron yellow. [Two out of the three strains examined by Gordon did not clot milk.]

SECTION III.—BIOLOGICAL PROPERTIES.

1. Viability. Virulence.

Viability.—The staphylococci do not form spores: but retain their vitality in culture for a very long time. In broth they will still be found living after the lapse of a year and on gelatin after an even longer time.

Cultures of staphylococci are easily killed by heat: e.g. exposure to a temperature of 55° C. for 24 hours, or of 80° C. for 15 minutes is sufficient to sterilize them. In dried pus or other albuminous material staphylococci will resist the action of steam at 100° C. for several minutes.

Staphylococci in culture are very susceptible to the action of antiseptics but when mixed with albuminoid substances are much more resistant.

Virulence.—The virulence of the staphylococci is subject to variation which cannot be anticipated. As a rule, virulence is markedly lowered in old cultures, and to maintain it, it is necessary to sow sub-cultures every 5 or 6 days and to pass the culture through a rabbit from time to time by intraperitoneal inoculation.



FIG. 292.—*Staphylococcus aureus*. Surface culture on agar (5 days).



FIG. 293.—*Staphylococcus albus*. Surface culture on agar (5 days).



FIG. 294.—*Staphylococcus citreus*. Surface culture on agar (5 days).

Staphylococci recovered from the circumambient media are often avirulent; sometimes even the staphylococcus isolated from a septic infection in man is absolutely devoid of virulence for laboratory animals.

The addition of glucose to culture media increases the virulence of staphylococci (Budjwid, Nicholas).

2. Bio-chemical reactions.

[Gordon from an investigation of a number of staphylococci obtained from various sources (air, skin, saliva, scurf, urine, sputum and pus) showed that "comparison between various staphylococci in regard to nine selected actions has revealed differences not merely of degree, but of kind, and has shown that a differentiation far more elaborate than has yet been supposed to exist naturally obtains amongst staphylococci."

[The tests used by Gordon were as follows:—

1. The action on gelatin (12 per cent.) with regard to liquefaction when incubated for one week at 22° C.
2. The clotting of litmus milk when incubated for one week at 37° C.
3. The peptonization of milk under the same conditions.
4. The reduction of nitrate to nitrite during incubation at 37° C. for three days.
5. The reduction of neutral red in a broth medium when incubated at 27° C. anaerobically for two days.
6. The production of acid in a slightly alkaline litmus broth containing 1 per cent. lactose when incubated at 37° C. for one week.

7. Similar conditions, but with maltose.
8. With glycerin.
9. With mannite.

[Though the experiments were not sufficiently extensive to allow of a classification of staphylococci they show quite clearly that the generally accepted grouping into three types depending upon the colour of the growth on an agar medium is insufficient.]

3. Toxin.

In cultures the staphylococcus produces fatty acids from sugars: it converts lactose into lactic acid and under certain conditions produces acetic, valerianic, butyric and propionic acids. Cultures also soon give off a musty smell if kept.

Staphylococci produce a little indol. The property of liquefying gelatin is due to the elaboration of diastases which also peptonize the white of egg. The cultures also contain soluble toxins.

I. De Christmas filtered a broth culture of the *Staphylococcus aureus* through a Chamberland bougie and precipitated the filtrate with 4 or 5 volumes of strong alcohol. The precipitate was poured on to a filter paper, washed with alcohol and dissolved with water. The solution thus obtained has some power of producing inflammation, and injected into the anterior chamber of the eye of a rabbit sets up a slight degree of suppuration.

II. Leber extracted from cultures a crystallizable substance soluble in alcohol, which has marked properties of producing inflammation, suppuration and even necrosis of the tissues into which it is injected. Leber calls this substance *Phlogosine*.

III. Rodet and Courmont investigated the toxic products of the *Staphylococcus pyogenes* more thoroughly.

(a) Broth cultures incubated for 20 days at 35° C. were heated for 24 hours at 55° C. to kill the micro-organisms and then filtered through paper. The filtrate was feebly toxic for dogs and rabbits.

In dogs symptoms of poisoning were seen after the inoculation of 1.3 c.c. per kg. of body weight, but death only occurred rapidly (at the earliest in 17 hours) on the inoculation of a formidable dose (35 c.c. per kg.) into the jugular vein. Under these conditions it produced a fall of temperature, sickness, convulsions and tremors and tended to stop the heart and respiration.

Rabbits are still less susceptible. A rabbit weighing 1900 grams inoculated with 10 c.c. of heated culture only died at the end of 6 days after having lost flesh and weight.

The toxin is very unstable and rapidly loses its properties on keeping.

(b) A culture 20 days old filtered through a Chamberland bougie is even less toxic. After the inoculation of doses as large as 10 and 15 c.c. into the veins of rabbits weighing 2 kg. the animals only showed a transitory rise of temperature without any loss of weight.

(c) Cultures 20 days old were decanted and the clear liquid filtered through several folds of paper. The filtrate was precipitated with four times its weight of strong alcohol, and the precipitate washed with alcohol, dried and dissolved in water.

1. The extract so obtained was only slightly toxic.

To kill a dog weighing 6 kg. in 2 hours it was necessary to inject into the veins a quantity corresponding to 260 c.c. of culture. The symptoms were dyspnoea, Cheyne-Stokes' breathing, sub-normal temperature, tremors, convulsions and spasms.

The rabbit is more resistant: it does not succumb to doses corresponding to

50 c.c. of culture. An animal inoculated with the precipitate recovered from 140 c.c. of culture survived for a week.

2. The alcoholic solution was separated by filtration from the albuminoid precipitate and evaporated *in vacuo*: it gave a residue which was dissolved in water.

Two dogs weighing 9 kg. each did not succumb after the intra-venous inoculation of doses of this solution corresponding to 200 c.c. and 500 c.c. of culture. A dog weighing 10 kg. succumbed to an inoculation representing 210 c.c. of culture after suffering from a generalized anaesthesia, loss of reflexes and finally stoppage of the heart and respiration.

The rabbit is less susceptible. It never succumbed rapidly to the inoculation of the material soluble in alcohol. One animal survived the inoculation of a dose representing 85 c.c. of culture for 20 days.

The authors concluded that the substances soluble in alcohol (toxin 2) on the one hand and those insoluble in alcohol (toxin 1) on the other separately injected are more toxic than the mixture: that these two groups of substances are in fact antagonistic to and partially neutralize each other. The feeble toxicity of the products obtained by Rodet and Courmont is of considerable interest and the experiments are worth repeating.

IV. Mosny and Marcano obtained cultures in broth which after filtration killed rabbits in a few seconds when inoculated intra-venously in doses of 10 c.c. In doses of 1-2 c.c. the filtrate produces cachexia terminating in death in 5-6 weeks. Animals which survive the inoculation of toxin never exhibit any immunity against the *Staphylococcus pyogenes*.

Leucocidine.—Van de Velde by inoculating a culture of the staphylococcus into the pleural cavity of a rabbit obtained an exudate rich in degenerated white cells. This exudate mixed with normal leucocytes rapidly destroyed the latter. It contained a substance, leucocidine, which behaved as a soluble ferment and was destructive to white cells. This substance is not a product of reaction of the organism because it is produced in cultures (Bail).

Staphylolysin.—Neisser and Wechsberg have demonstrated the presence of an hæmolysin in cultures of the staphylococcus. If a drop of rabbit's blood be added to a culture of the staphylococcus in broth (either filtered or unfiltered) it will be found that after standing in the ice-chest for a few hours the blood is completely hæmolyzed.

The best method of preparing the hæmolysin is as follows:—Sow a distinctly alkaline broth (add one-third of the quantity of alkali necessary to make the broth alkaline to phenol-phthaleïn) with a staphylococcus and incubate for 12 days. Filter and add a little carbolized glycerin to the filtrate to ensure its keeping. The filtrate must also be kept in the ice-chest, as the hæmolysin is destroyed in a few days at the ordinary temperature of the laboratory and much more rapidly at 48-56° C. Not all strains of staphylococci produce an hæmolysin: non-pathogenic staphylococci are incapable of hæmolyzing blood (Otto).

Small doses of hæmolysin inoculated into rabbits sub-cutaneously cause a rise of temperature and induration at the site of inoculation. If the inoculations be repeated the serum becomes anti-hæmolytic.

Normal human serum and normal horse serum both possess anti-hæmolytic properties.

4. Vaccination.

[Human vaccination in staphylococcal infections.—Since their introduction by Wright the inoculation of killed organisms has been extensively adopted and with much success in the prophylaxis and treatment of human staphylococcal infections and especially of furunculosis, carbuncles, acne, sycosis, chronic bronchitis, catarrh of the upper respiratory passages, etc.

[The organism must be isolated from the particular lesion it is proposed

to treat and the vaccine prepared according to the method described for the preparation of streptococcal vaccines (p. 605). A carbolic vaccine appears to give better results than an heated vaccine and the emulsion should be of such an opacity that quarter-inch type can be read through it when contained in a $6 \times \frac{3}{4}$ in. tube. If a thicker emulsion be made the organisms may survive the action of the carbolic acid for several days.

[For the treatment of staphylococcal infections an initial dose of 250×10^6 organisms may be inoculated and the dose repeated at intervals of five to seven days. If necessary the dose may be increased as the treatment proceeds but care must be taken that too large a dose be not inoculated otherwise the beneficial results will not be obtained.]

5. Serum therapy.

About this branch of the subject there is still much to learn. The experiments are few in number and have not infrequently yielded contradictory results.

Mosny and Marcano failed in their attempts to vaccinate rabbits by inoculating them with small doses of an active toxin.

According to Courmont only toxins soluble in alcohol possess vaccinating properties; the substances precipitated by alcohol on the other hand predispose to infection. By injecting the soluble toxin prepared by the methods described above, Courmont has been able to obtain some degree of immunity. The serum of animals so treated appears to attenuate the virulence of the staphylococcus. Control experiments by Tavel have failed to confirm the researches of Courmont.

Viquerat and Kosc, and Parascandolo obtained a serum which is both prophylactic and therapeutic. This serum, prepared by inoculating into animals virulent cultures in sugar broth which have been sterilized by the addition of 5 per cent. of carbolic acid, is said to be both antitoxic and bactericidal.

Capman inoculated rabbits and dogs with a filtered culture of a staphylococcus grown in 1 per cent. peptone broth and incubated at 37°C . for 3 weeks. After several injections of toxin the animal was left alone for a fortnight or 3 weeks and then bled. This blood was both bactericidal and antitoxic, and inoculated into guinea-pigs and rabbits protected them from and even cured them of a staphylococcal infection.

Paltchikowsky immunized a horse with repeated sub-cutaneous inoculations of a culture of the *Staphylococcus aureus*, and obtained a serum which when injected sub-cutaneously protected the animal against twice the fatal dose of staphylococci injected into the veins.

According to Proscher only the inoculation of living staphylococci leads to the production of an active antistaphylococcal serum. Proscher inoculated goats and horses with a very virulent staphylococcus recovered from a boil on the lip. A goat which in the space of a month was inoculated with 7 agar cultures and 30 broth cultures of this staphylococcus yielded a serum of which 1-3 c.c. inoculated under the skin protected rabbits against five times the fatal dose of the virus inoculated into the veins.

6. Agglutination.

Kolb and Otto prepared a serum possessing marked agglutinating properties. This serum (prepared with a staphylococcus isolated from the human subject) has powerful agglutinating properties for the *Staphylococcus pyogenes* but is without any action on saprophytic non-pathogenic staphylococci (this test may be applied in the identification of the organism).

The serum obtained by Proscher (*vide ante*) agglutinates virulent staphylococci in high dilutions (1–2500).

The serum of a person suffering from a staphylococcal infection has no agglutinating properties.

SECTION IV.—THE DETECTION, ISOLATION AND IDENTIFICATION OF THE STAPHYLOCOCCI.

In suspected staphylococcal infections the pus, blood and exudates should be examined.

(a) **Microscopical examination.**—Films and smears made with blood, pus, etc. should be stained :

1. Some, with one of the solutions containing carbolic acid—(Kühne's blue, carbol-thionin, or dilute carbol-fuchsin).
2. Others, by Gram's method. The staphylococci are gram-positive and

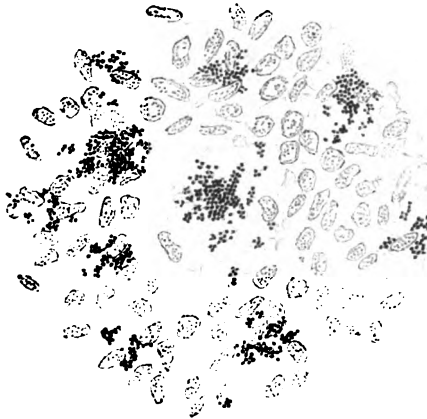

FIG. 295.—*Staphylococcus aureus*. Pyemic abscess of the lung. Gram's stain and eosin. (Oc. 2, obj. $\frac{1}{7}$ th, Zeiss.)

by double staining, using eosin for the ground-work, very pretty preparations are obtained.

(b) **Cultures.**—The staphylococcus may not be present in pure culture in the original material, and sometimes more than one variety of staphylococcus may be present, so that methods of isolating the organisms in pure culture will have to be adopted.

1. Sow a drop of the material in a tube of broth (this will give a culture of all the organisms present).

2. To isolate the different organisms sow a loopful of the material on the surfaces of three agar tubes without recharging the needle, according to the method described at p. 82. In this way single colonies are obtained which it is quite easy to differentiate.

Gelatin plates may also be sown, but this method is liable to lead to error, as some organisms such as the pneumococcus and the streptococcus may pass unnoticed.

Note.—In investigating the organisms present in a septic infection it must be remembered that staphylococci are quite commonly found on the surface of the skin, so that every precaution must be taken to eliminate this possible source of

error (Chap. XII.). It is well to cauterize a small area of the surface through which to pass the needle or pipette for the collection of the material.

(c) **Inoculations.**—To ascertain the virulence of cultures, rabbits should be inoculated both sub-cutaneously and also intra-venously into the ear vein.

Diplococcus crassus.

The organism isolated by Jæger from cases of cerebro-spinal meningitis and identified by Jæger and Huebner with the Meningococcus (Chap. XLVII.) is clearly a different organism from the latter and is identical with the *Diplococcus crassus*. It is a saprophyte inhabiting the pharynx but may be found in association with the Meningococcus and even with the tubercle bacillus in cases of meningitis. It differs mainly from the Meningococcus in the following particulars:

1. **Staining reactions.**—The *Diplococcus crassus* is gram-positive.
2. **Cultures.**—It grows on ordinary media at 20° C. and above.
3. **Fermentation reactions.**—It ferments nearly all the sugars notably levulose, galactose, lactose and saccharose on all of which the Meningococcus has no action.
4. **Agglutination.**—The *Diplococcus crassus* is not, as a rule, agglutinated by an antimeningococcal serum: occasionally however agglutination is noticed with dilutions of 1 in 25 and 1 in 50. But this is a *group-agglutination* similar to that which occurs with the Gonococcus and referred to later (Chap. XLVII.).

An anticrassus serum has no agglutinating action on the Meningococcus (Wassermann).

The organism described by Lepierre as a Meningococcus exhibits all the characteristics of the Jæger-Huebner coccus and is apparently identical with that organism: Lepierre found that the virulence was increased by passage through the peritoneal cavities of rabbits.

CHAPTER XLIV.

THE ENTEROCOCCUS.

Introduction.

Section I.—Experimental inoculation, p. 627.

Section II.—Morphology and biological properties, p. 628.

Section III.—Detection and isolation of the enterococcus, p. 629.

SEVERAL years ago Escherich, Tavel, Eguet, recorded the finding of encapsulated streptococci in the intestines of new-born children, and in 1894-7 Besson described a new "encapsulated streptococcus" which he had isolated from two cases of post-typhoid suppuration (purulent pleurisy, multiple suppurative arthritis). These organisms are identical with the *Enterococcus*, of which Thiercelin gave the classical description.

The *Enterococcus* is a saprophytic micro-organism which under certain conditions may become pathogenic: it is widely distributed and occurs in the alimentary canal, in the mouth, nose and pharynx, on the skin, in the vagina, etc.

It plays an important rôle in the enteritis of children and adults as well as in infections of the liver; it is also the cause of some cases of meningitis, broncho-pneumonia, etc., as well as of some of the complications of enteric fever and tuberculosis.

Rosenthal has described a disease of the lungs due to this organism, characterized by a pseudo-lobar broncho-pneumonia accompanied with severe general symptoms, and followed by a condition of cachexia which may lead to it being mistaken for pulmonary tuberculosis.

SECTION I.—EXPERIMENTAL INOCULATION.

The virulence of the enterococcus is very variable: often the organism is totally devoid of pathogenic power.

Mice are very susceptible to infection; sub-cutaneous inoculation of a virulent strain leads to death from septicæmia in 24-48 hours. The organism may be found in the blood, internal organs and in the diarrhœal contents of the intestine.

Rabbits are less susceptible though intra-venous inoculation of a virulent strain produces a fatal septicæmia: intestinal lesions are always present *post mortem*. The enterococcus isolated by Besson from one of his cases of post-typhoid suppuration produced multiple suppurative arthritis on intra-venous inoculation into rabbits and killed the animals in a fortnight to 3 weeks.

Guinea-pigs again are less susceptible than mice but they also die of cachexia several weeks after being inoculated with an enterococcus the virulence of which has been raised by passage through mice (Thiercelin). According to Rosenthal lesions are found in the intestines of guinea-pigs killed by intra-venous inoculation.

The saprophytic enterococcus becomes virulent after passage through animals (Thiercelin and Jouhaud). These observers inoculated a large dose of a broth culture of the saprophyte beneath the skin of a rabbit : an abscess formed at the site of inoculation and the enterococcus was found in the pus. When this pus was inoculated into mice the latter died of septicaemia in 2 or 3 days : after a second passage the mice died in 24-48 hours.

SECTION II.—MORPHOLOGY AND BIOLOGICAL PROPERTIES.

1. Microscopical appearance.

The enterococcus is highly pleomorphic. In normal stools it appears as a diplococcus, the cocci being rounded, oval, or more or less lancet-shaped, very variable in size and rarely encapsulated; sometimes the two elements are arranged at an angle to each other. Frequently the two cocci in a diplococcus are of different shapes and unequal in size, one rounded, the other lancet-shaped.

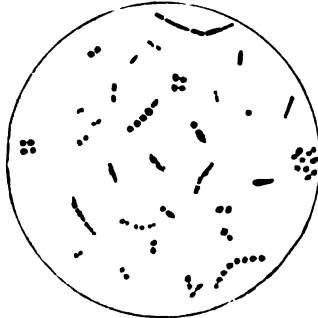

FIG. 296.—*Enterococcus*. Film from an agar culture exhibiting the pleomorphism of the organism. Carbol-blue. (Oc. II, obj. $\frac{1}{3}$ th, Reich.)

In pus, in the stools of cases of enteritis, and in the blood of mice the appearance is similar except that many of the cocci are encapsulated and look like the pneumococcus. Two diplococci arranged in a chain and also—sometimes—diplo-bacilli may be found.

In young cultures numerous diplococci, tetrads and short chains are found; in older cultures the chains are longer and have the appearance of streptococci. Sometimes, and especially on agar, the cocci are elongated and have a bacillary appearance.

Staining reactions.—The enterococcus is easily stained by the basic aniline dyes. It is gram-positive.

2. Cultural characteristics.

Conditions of growth.—The enterococcus grows at ordinary temperatures, but best at 35°-37° C. : it produces neither gas nor indol. Broth and agar are very suitable media for its growth; liquid serum is not a good medium.

In artificial culture the enterococcus is indifferently aerobic. In the tissues while living as a parasite it grows better under anaerobic conditions and is sometimes strictly anaerobic : but this strict anaerobiosis is merely temporary and after passage through broth *in vacuo* the organism grows aerobically (Thiercelin, Rosenthal).

Culture media. Broth.—After incubating for 24 hours the broth is cloudy; later it becomes clear, a whitish mucous deposit falling to the bottom of the tube.

Blood-broth.—There is a slight cloudiness at first, and then a mucous layer containing numerous micro-organisms floats for a time in the liquid, but

later falls to the bottom of the culture vessel. Chains and capsulated diplococci are found on microscopical examination of these cultures.

Liquid serum.—The growth in this medium is very scanty and consists of a small glairy deposit made up of diplococci and encapsulated cocci in chains.

Agar.—The growth consists of small rounded points which are at first transparent but afterwards opaque and often have a streaky blue appearance, resembling a culture of streptococci.

Gelatin.—On gelatin, small white opaque rounded points are formed similar to colonies of streptococci: the medium is not liquefied.

Milk.—The growth in milk is very poor. Coagulation is not a constant phenomenon.

Potato.—No apparent growth takes place on potato but a microscopical examination of the scrapings of the surface of the medium will show that there has undoubtedly been some multiplication.

Vitality and virulence.—In liquid media the enterococcus retains both its vitality and virulence for a long time; Thiercelin was able to sow sub-cultures from a broth culture several weeks old, and Besson killed rabbits with a culture which had been sub-cultivated six times in blood-broth: in anaërobic culture the vitality is maintained for several years. The addition of appreciable traces of antiseptics (carbolic acid, etc.) does not hinder the growth of the cultures.

Toxins.—The saprophytic enterococcus though incapable of infecting the rabbit will nevertheless often kill the animal by toxæmia. Following an injection of culture, the animal sickens and becomes cachectic, develops paraplegic symptoms and dies on an average in a fortnight to 25 days. *Post mortem* large purulent lesions are frequently found, but the only organisms present are organisms of secondary infection (staphylococci, etc.). Sub-cutaneous inoculation of a culture of the saprophyte filtered through a Chamberland bougie leads to the death of the rabbit from cachexia (Thiercelin and Jouhaud): the same result is obtained with cultures which have been sterilized by boiling for half an hour or by heating at 110° C. for 15 minutes. The addition of iodine has no action on the cachexia-producing properties of the toxin (Rosenthal and Charazain).

SECTION III.—DETECTION, ISOLATION AND IDENTIFICATION OF THE ENTEROCOCCUS.

A. The isolation of the enterococcus from pathological material is easy; a small portion should be sown in broth both aërobically and anaërobically, and the organism may then be isolated in the ordinary way on sloped agar or on plates. The colonies of the enterococcus can be recognized by their characteristic appearance, and may be picked off and sown in broth to obtain pure cultures.

Note.—In pathological material the enterococcus, as has already been stated, often closely resembles the pneumococcus and erroneous conclusions may be drawn from microscopical examination if this fact be not borne in mind.

B. The isolation of the enterococcus from stools is more difficult on account of the presence of other easily growing organisms: Thiercelin describes two methods:—

(a) Dilute a trace of the stool in a tube of broth, filter through a double layer of filter paper (the funnel and paper both being sterile) into a sterile tube, and sow several agar-slope tubes with the filtrate. After incubating for 24 hours, the tubes will show numerous colonies of the enterococcus: the

majority of the organisms have been retained on the filter, the enterococcus being almost the only species which has passed through.

(b) Sow a trace of the stool in broth, aspirate the liquid into a Roux's pipette and incubate at 37° C. for 24 hours *in vacuo* ; then sow a number of agar-slope tubes with the contents of the pipette after diluting the latter in sterile broth. After incubating the agar tubes for 24 hours at 37° C. numerous colonies of the enterococcus are seen ; other organisms are few in number.

C. The virulence of the enterococcus should be tested by inoculating mice and rabbits with 24 hour old broth cultures.

D. The identification of the organism should be based upon a consideration of all of the following points :

1. The pleomorphism of the micro-organism : in pathological exudates and in mouse's blood it has the appearance of the pneumococcus, in cultures a few days old it resembles the streptococcus.
2. The growth on gelatin at 20° C.
3. The minimal amount of growth in liquid serum.
4. The prolonged vitality of the organism.
5. The fact that in many cases it must be grown anaërobically before it will grow under aërobic conditions.

CHAPTER XLV.

MICROCOCCUS TETRAGENUS.

Introduction.

Section I.—Experimental inoculation, p. 631.

Section II.—Morphology, p. 632.

Section III.—Biological properties, p. 632.

Section IV.—Detection, isolation and identification of the organism, p. 633.

THE *Micrococcus tetragenus* was first noticed by Koch in some pus from a cavity in the lung. The characteristics of the organism were studied by Gaffky.

The *Micrococcus tetragenus* is very commonly present on the skin and is found also in the saliva, stomach and nasal mucus of healthy persons. Outside the body it occurs as a saprophyte and is often found in the air. Under certain conditions it may become pathogenic: it is frequently associated with the tubercle bacillus in tuberculosis of the lung, in some cases it is the cause of sore throat ("angines sableuses" of Dieulafoy and Appert), sometimes of suppuration in very various parts of the body (purulent pleurisy, adenitis, meningitis, dental abscess, furunculosis, etc.) and occasionally of septicæmia.

SECTION I.—EXPERIMENTAL INOCULATION.

As in the case of the staphylococci the virulence of the *Micrococcus tetragenus* is very variable. For purposes of experimental inoculation a virulent strain must be used.

Mice.—White mice are very susceptible. A few drops of a broth culture inoculated beneath the skin leads to death from septicæmia in 24–48 hours; the blood and internal organs will be found to contain numerous tetrads.

Guinea-pigs.—In guinea-pigs, sub-cutaneous inoculation is followed by the formation of an abscess containing thick pus: death may occur in 3–5 days, but as a rule the disease is less acute. Intra-peritoneal inoculation is a more severe mode of infection than the sub-cutaneous method and leads to a fatal result in a few days: *post mortem* a purulent effusion will be found in the peritoneal cavity and the organism can be isolated from the blood and internal organs.

Rabbits.—Rabbits are less susceptible. Sub-cutaneous inoculation leads to the formation of a cold abscess (Tissier) while intra-peritoneal inoculation is followed by peritonitis with a collection of thick pus in the peritoneal cavity.

SECTION II.—MORPHOLOGY.

1. Microscopical appearance.

In sputum, pus and blood the *Micrococcus tetragenus* appears as single cocci, diplococci or as tetrads. The individual cocci are large, often exceeding 1μ in diameter; they are sometimes oval and shaped like an haricot bean, and are frequently surrounded by an irregular capsule.

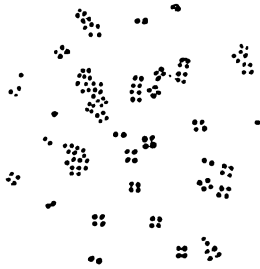

FIG. 297.—*Micrococcus tetragenus*. Film from an agar culture. (Oc. II, obj. A₁th, Reich.)

In cultures on ordinary media the organism grows as single cocci or as diplococci, the diameter seldom exceeding $0.6-0.7\mu$; the tetrad form is rarely seen under these conditions, and capsules cannot be found. In cultures on liquid rabbit serum the tetrad forms with capsules can be demonstrated.

Staining reactions.—The micrococcus is easily stained by the ordinary methods and is gram-positive. Capsules may be stained in the usual way but are often poorly defined and irregular.

2. Cultural characteristics.

The *Micrococcus tetragenus* grows on the ordinary media at temperatures above 15°C . : at 20°C . growth is slow : the optimum temperature is about 37°C . It is aerobic.

Culture media. Broth.—At first the medium becomes slightly cloudy but as growth proceeds a thick ropy deposit is formed.

Gelatin.—Gelatin is not liquefied. Single colonies grow as small convex white points 1–2 mm. in diameter.

Stab cultures give rise to small isolated white colonies in the depth of the medium and a white heaped-up growth on the surface (tylotate growth).

Chauffard and Ramond have described a strain of the coccus which liquefies gelatin to a slight extent. Chromogenic varieties also exist, viz. : *M. t. aureus*, *M. t. subflavus* and *M. t. ruber*.

Agar.—On this medium growth appears as white colonies which become confluent and form a creamy white viscous layer.

Potato.—Rounded colonies appear which coalesce and form a white viscous layer.

Liquid rabbit serum.—The medium becomes cloudy and a whitish deposit consisting of capsulated organisms is precipitated.

Milk.—The organism grows feebly in milk and does not coagulate the medium.

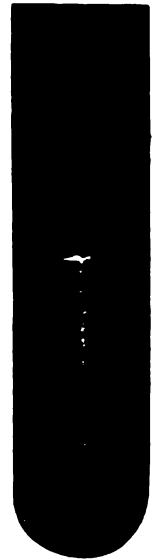

FIG. 298.—*Micrococcus tetragenus*. Stab culture in gelatin.

SECTION III.—BIOLOGICAL PROPERTIES.

Viability.—The organism remains alive in culture media for several months. A temperature of 60°C . for a few minutes is sufficient to sterilize it.

The **virulence** varies much with different strains; virulent strains retain their properties in culture almost indefinitely.

Relying chiefly on differences in virulence some observers have described several varieties of the micrococcus (*M. t. septicus*, *M. t. variabilis*, *M. t. concentricus*, *M. t.*

aureus, etc.) but Boldoni has shown that the characteristics of these varieties are not stable. Pigment formation is not at all constant.

An apparently saprophytic micrococcus can be made virulent by growing it in a collodion sac in the peritoneal cavity of a guinea-pig.

Cultures sterilized by filtration or by heating at 60° C. are very feebly toxic and are not pyogenic.

SECTION IV.—DETECTION, ISOLATION AND IDENTIFICATION OF THE ORGANISM.

On microscopical examination the organism will be recognized by its characteristic appearance. Isolation is easy on gelatin plates—the medium is not liquefied. The micrococcus is differentiated from the staphylococci by the fact that it does not coagulate milk [—some staphylococci however do not clot milk (p. 620).]

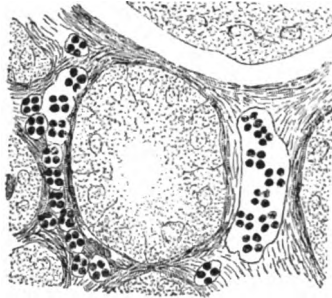

FIG. 299.—*Micrococcus tetragenus*. Section of a mouse's kidney. × 1200.

In those cases in which the strain is virulent the identification of the organism may be completed by the inoculation of a mouse; in this animal the organism will give rise to a condition of septicæmia and the encapsulated micrococci will be found in large numbers in the blood, internal organs, etc.

CHAPTER XLVI.

THE GONOCOCCUS.

Introduction.

Section I.—Experimental infection, p. 635.

1. Man, p. 635. 2. Animals, p. 635.

Section II.—Morphology, p. 635.

1. Microscopical appearance and staining reactions, p. 635. 2. Cultural characteristics, p. 638.

Section III.—Biological properties, p. 640.

1. Vitality and virulence, p. 640. 2. Toxin, p. 640. 3. Serum therapy. Agglutination. Vaccination, p. 641.

Section IV.—Detection and isolation of the gonococcus, p. 642.

THE *Gonococcus* is the infecting agent in gonorrhœa (Neisser). The organism may be found in cases of gonorrhœa in the pus from the urethra¹ and the vagina, and in the other lesions of the genital tract complicating gonorrhœa; for example, it can be recovered from Bartholin's glands, and from the uterus, Fallopian tubes and peritoneum when these structures are affected. The gonococcus leads in some cases to cystitis, to suppurative affections of the kidneys, gonorrhœal proctitis, gonorrhœal ophthalmia and the purulent ophthalmia of newborn children.

It may pass into the blood stream and give rise to a true septicæmia (Hallier, Krause). Glon and Schlagenhauer, and others have recorded cases in which the organism has been found in the lesions of gonorrhœal endocarditis, and Petrone and Kammerer have found it in the pus of gonorrhœal arthritis. As a rule, it rapidly disappears from and cannot be found in the exudation accompanying gonorrhœal rheumatism because it remains limited to the articular tissues in which it lives for a long time but it may be detected by sowing cultures with the inflamed synovial membrane (Vaquez). Bressel found it in a case of pneumonia supervening on the subsidence of an attack of gonorrhœa. De Josselin and de Jong found the gonococcus in the cerebro-spinal fluid of a young man suffering from cerebro-spinal meningitis following an attack of gonorrhœal urethritis.

During the first stage of an attack of gonorrhœa the gonococcus is as a rule present in pure culture in the urethra. But before long other organisms—the colon bacillus, the organisms of suppuration, diplococci, and various organisms described by Bumm

¹ Inflammatory conditions of the urethra are sometimes seen which are not due to the gonococcus (pseudo-gonorrhœa of Bockart); among these may be noted urethral inflammations due to caustics, to the ordinary organisms of suppuration—staphylococci and streptococci (Bockart), to herpes, to the colon bacillus (Van der Bluyin, Haay, Besson), to gout, rheumatism, syphilis, tuberculosis, etc. Urethral inflammations in dogs and other animals are caused by organisms other than the gonococcus.

and others—invaade the urethra and may either live symbiotically with the gonococcus or altogether displace the latter. These secondary organisms may be the cause of various complications of gonorrhœa, as for instance abscesses, suppurations, endocarditis.

Though the gonococcus in many ways closely resembles the meningococcus and the micrococcus catarrhalis, these three organisms constitute distinct species.

SECTION I.—EXPERIMENTAL INFECTION.

Symptoms and lesions in susceptible animals. Man.—(a) Welander produced gonorrhœa in the human subject by inoculating pus containing the gonococcus into the urethra.

(b) Bumm inoculated a pure culture of the gonococcus into the urethra of a woman and set up a typical attack of gonorrhœa which lasted 3 weeks; the pus from the urethra contained the gonococcus.

(c) Bockhart inoculated into the urethra of a man in the last stages of general paralysis a gelatin culture of the gonococcus. A typical attack of gonorrhœa resulted which was followed by suppurative nephritis; the gonococcus was found in pus from the urethra and in the renal abscess.

(d) Bokai inoculated pure cultures into the urethras of six students and produced gonorrhœa in all of them. Brenner, Wertheim, Finger, Schlagenhauer, Keifer similarly all obtained positive results.

Animals.—Animals are not so susceptible to infection with the gonococcus as man. Sub-cutaneous inoculation produces a transitory inflammation: in one case Finger obtained a small abscess.

Urethral inoculations in dogs, rabbits, horses and monkeys fail to produce a clinical condition of gonorrhœa. Fonseca, however, by inoculating cultures into the urethra of a rabbit produced a slight attack of gonorrhœa which only lasted a week or 10 days.

Legrain obtained a slight purulent conjunctivitis in guinea-pigs; gonococci were found within the pus cells. In young rabbits the gonococcus produces a typical purulent conjunctivitis; the organism however does not increase in numbers but rapidly disappears from the ocular conjunctiva. The inflammation is due to the toxin, since sterilized cultures give the same result (Morax).

By inoculating cultures into the joints of rabbits, Finger and Schlagenhauer caused an acute arthritis which very quickly passed off.

By intra-uterine inoculation in female rabbits Malovski set up suppuration of the Fallopian tubes with peritonitis which was fatal in 24 hours.

Inoculation of very virulent cultures into the peritoneum of young guinea-pigs may cause death from septicæmia (Morax). Pinto by inoculating large doses of cultures into the peritoneal cavities of very young rabbits produced a septicæmia with very great difficulty; but after passage through a series of rabbits the virulence of the organism was so increased that a dose of 0·000,02 c.c. per kg. of animal weight was fatal. These researches have been confirmed by Bruckner and Christeanu who have succeeded in considerably raising the virulence of the gonococcus by passage through the peritoneal cavities of rabbits and cats.

SECTION II.—MORPHOLOGY.

1. Microscopical appearance.

The gonococcus occurs as small grains generally arranged in pairs and having the appearance of two kidneys or haricot beans; their long diameter

varies from $0.6-0.8\mu$. The two cocci have their concave faces adjacent: sometimes they are found grouped in staphylococcal masses but never in chains. In cultures the cocci are rounded or oval and very unequal in size.

The two elements of the diplococcus are held together by a mucous matrix analogous to the capsule of the pneumococcus but very difficult to demonstrate. It can be stained in old cultures with carbol-fuchsin.



FIG. 300.—*Gonococcus* in pus from the urethra. Jenner's stain. (Oc. 2, obj. $\frac{1}{15}$ th, Zeiss.)

In cultures the gonococcus shows movements both of oscillation and of translation (Eraud and Hugounenq).

In gonorrhoeal pus, the gonococci are sometimes free but more often situated within pus or epithelial cells. This intra-cellular position is one of the important morphological characteristics of the organism.



FIG. 301.—*Gonococcus* in pus from the urethra. Pappenheim's stain. (Oc. 2, obj. $\frac{1}{15}$ th, Zeiss.)

In pus from the urethra the gonococcus is found in pure culture during the first few days. In the early stages the organisms are few in number and are found almost entirely within the polymorpho-nuclear leucocytes: numbers of epithelial

cells are seen in the films but very few of them contain gonococci. Towards the third day, the number of gonococci increases and a large proportion of the leucocytes contain the organism. A little later still the epithelial cells disappear, and the majority of the gonococci are intra-cellular and are so numerous that about 15-20 per cent. of the leucocytes are invaded. At a later stage of the disease secondary infections take a part in the inflammatory process and as the acute symptoms pass off the epithelial cells again become numerous; but it is only when the disease enters upon the chronic stage that gonococci are again found within them and the pus cells diminish in number.

Staining reactions.—The gonococcus stains easily with the basic aniline dyes and is gram-negative: *it is upon the latter fact that its identification is based* (G. Roux).

A. Stain first with a single stain such as dilute carbol-fuchsin or carbol-thionin. All the organisms are stained.

B. Stain a film with carbol-violet, examine under the microscope and then treat by Gram's method. The gonococci will be decolourized and the only organisms which will retain the violet are organisms of secondary infection such as staphylococci, the diplococcus described by Legrain, Bumm, etc.

C. A film should also be double stained by one of the methods based upon the principle that if a film be stained by Gram's method the gram-positive organisms will be the only organisms stained, and if at this stage some other dye in contrast to violet be applied the gram-negative organisms become stained by it.

The following is a list of the special methods suitable for staining films for the detection of the gonococcus:

Steinschneider's method.—1. Stain with Ehrlich's violet, then with Gram's iodine solution, decolourize in absolute alcohol and wash in water.

2. Stain with an aqueous solution of vesuvin, wash, dry, and mount.

The gonococci and the ground work are stained brown, and the gram-positive organisms violet.

Nicolle's method. Recommended.—1. Stain with carbol-violet, then with Gram's iodine. Decolourize in acetone-alcohol (p. 143), wash in water.

2. Stain with a drop of a diluted alcoholic solution of fuchsin for a few seconds.

| | | | |
|---|---|---|--------|
| Saturated alcoholic (95 per cent.) solution of fuchsin, | - | - | 5 c.c. |
| Distilled water, | - | - | 100 " |

Wash, dry, and mount.

The gonococci are stained by the fuchsin, the other organisms by the violet.

Plato's method.—This method depends upon the use of neutral red, a reagent which stains the living gonococci in fresh pus cells, leaving the leucocytes, the extra-cellular gonococci and the secondary micro-organisms, whether intra-cellular or extra-cellular, unstained.

The method is useful for detecting gonococci but cannot be used for permanent preparations.

The staining solution should be made up immediately before being used:

| | | | |
|--|---|---|--------|
| Saturated aqueous solution of neutral-red, | - | - | 1 c.c. |
| Normal saline solution, | - | - | 100 " |

Mix a drop of pus with a loopful of the stain on a slide, cover with a cover-glass and examine under the microscope.

Wahl's method.—Wahl recommends the following stain for staining gonococci in sections. The solution keeps well:—

| | | | |
|---|---|---|--------|
| Saturated alcoholic solution of auramine, | - | - | 2 c.c. |
| 95 per cent. alcohol, | - | - | 1.5 " |
| Saturated alcoholic solution of thionin, | - | - | 2 " |
| Saturated aqueous solution of methyl green, | - | - | 3 " |
| Distilled water, | - | - | 6 " |

[Jenner's stain and Pappenheim's stain are both useful for staining films of pus when searching for the gonococcus.]

2. Cultural characteristics.

Conditions of growth.—The gonococcus is an aerobic organism which can only be cultivated outside the body with some difficulty. It is necessary to use special media and those containing serum give the best results. The optimum temperature is 36°–37° C. though growth takes place at all temperatures between 21° and 39° C. The gonococcus ferments glucose but no other sugar.

Culture media. Broth.—In ordinary broth at a temperature of 36° or 37° C. the amount of growth is insignificant: towards the second day the medium is cloudy, but subsequently becomes clear, a slight greyish deposit falling to the bottom of the vessel. Vannod recommends veal broth containing no peptone as a useful culture medium. The broth is evaporated to one-fourth its volume and then one-third its volume of ascitic fluid is added.

Bruschettini and Ansaldo obtained abundant growths by adding a few drops of egg-yolk or egg-albumin to ordinary broth. According to these observers the best medium is:—

| | | | | | | | |
|---------------------|---|---|---|---|---|---|---------|
| Sterile beef broth, | - | - | - | - | - | - | 10 c.c. |
| Defibrinated blood, | - | - | - | - | - | - | 1 drop. |
| Fresh white of egg, | - | - | - | - | - | - | 1 " |

Urine (Finger).—In non-alkaline urine to which 0.5 per cent. peptone has been added and the whole sterilized, the gonococcus grows better than in broth. It produces a well-marked turbidity and a fairly copious precipitate. Hammer prefers a highly albuminous urine sterilized either in the autoclave or by filtration through porcelain.

Acid gelatin (Turrô).—The gonococcus grows quite well at 22° C. in an acid gelatin—ordinary gelatin which has not been neutralized—but the cultures are delicate and growth fails after the third or fourth sub-culture. The medium is not liquefied.

Stab culture.—After incubating for several days a very delicate white line appears along the line of the stab. The amount of growth is always very poor.

Single colonies.—Single colonies appear as raised, viscous, white, hemispherical points which always remain very small in size.

Ordinary agar.—A very scanty growth is obtained by sowing gonorrhœal pus on the surface of ordinary agar: the necessary albuminoid material is provided by the pus. The culture takes the form of a very thin glaze.

Cultures have very little viability. It seems impossible to sub-cultivate on agar for more than a generation or two and growth ceases generally after the second sub-culture. Wildbolz however by using a slightly alkaline agar has occasionally succeeded in sub-cultivating for several generations. Thalmann recommends ordinary agar made neutral to phenolphthaleïn. Vannod uses ordinary 1.5 per cent. agar made alkaline with 10 per cent. solution of sodium carbonate so that the mixture turns litmus paper very slightly blue.

Wertheim's agar.—Tubes of sterilized agar (about 6 c.c. in each tube) are liquefied by heat and cooled to 45° C. To each tube about 4 c.c. of human blood serum or sterile ascitic fluid are added with aseptic precautions. The contents of the tubes are mixed, sloped and allowed to cool. The tubes are sown when the medium has set.

It is an advantage both in this and in the following media to use glycerin-agar instead of ordinary agar.

Stroke cultures.—Stroke cultures incubated for 2–3 days at 37° C. give a narrow, thin, greyish, semi-transparent band with a moist lustrous surface.

Single colonies.—To obtain single colonies Wertheim's agar may be poured into Petri dishes and after solidifying sown by the parallel stroke method (p. 81). After incubating for 24 hours at 37° C. small, punctiform, viscous and transparent colonies appear; these increase in size and about the second or fourth day may be as large as a pin's head and hemispherical; examined with a lens, their edges are seen to be slightly sinuous and their centres whitish, semi-opaque or even opaque (Wildbolz).

Král's agar.—Král substitutes calf for human serum in Wertheim's agar.

Heiman's agar.—Proceeding as above, mix two parts of ordinary agar and one part of pleural fluid sterilized by discontinuous heating (p. 47). The medium should be neutral and if the serum be alkaline it should be added to a slightly acid agar.

Wildbolz' agar.—Heffter having shown that fluid from ovarian cysts—which contains a large amount of pseudo-mucin—may with advantage be used instead of ascitic fluid in the preparation of media for the gonococcus, Wildbolz recommends an agar containing pseudo-mucin.

Melt some ordinary agar and add 5 per cent. of finely powdered pseudo-mucin.¹ Heat the mixture to 100° C. for an hour, filter while hot, distribute into tubes and sterilize at 100° C.

Abe's agar.—Take 500 grams of beef, cut off all the fat, mince and macerate in 1 litre of water for 20 hours in the ice chest. Filter through paper, then through a Chamberland bougie.

To the filtrate add ordinary nutrient agar which has been melted and cooled to 50° C. in the proportion of two parts of meat extract to five of agar. Distribute in tubes or Petri dishes. The medium is transparent and very suitable for the growth of the gonococcus.

Pfeiffer's blood-agar.—This medium is prepared by simply spreading a few drops of sterile fresh human blood on agar plates. The characteristics of the growth are the same as those on Wertheim's agar (Ghon and Schlagenhauser, Abel).

Bezanson and Griffon's blood-agar (p. 53).—This is a very useful medium for growing the gonococcus.

Tubes of blood-agar sown with a liberal amount of gonorrhoeal pus and incubated at 37° C. show, after 24 hours, a copious growth consisting of flat, rounded, moist, transparent, lustrous colonies of variable size, sometimes coalescing to form a viscous layer with pinked edges. The medium which is in the first instance red becomes chocolate-coloured as growth proceeds, the colonies being delicately picked out in white.

Nasstikoff's agar.—This medium is recommended by Steinschneider for the cultivation of the gonococcus. Collect the yolk of an egg in a sterile manner (p. 54) and mix it thoroughly with three times its volume of sterile water. Liquefy a few tubes of sterile agar each containing about 6 c.c., and when they have cooled to 45° C. add 2 c.c. of the egg emulsion to the contents of each tube, being careful to avoid contaminations. Mix carefully, slope the tubes and allow to set.

Leipschutz' agar.—Prepare a 2 per cent. solution of the substance sold by Merck as "powdered egg-albumin." To 100 c.c. of this solution add 20 c.c. of deci-normal soda solution. Stand for half an hour and filter through



FIG. 302.—*Gonococcus*. Stroke culture on glycerin-ascitic-agar (3 days at 37° C.).

¹ Pseudo-mucin is obtained by precipitating the fluid from ovarian cysts with alcohol.

filter paper. Distribute in small Erlenmeyer flasks and sterilize by heating at 100° C. on three separate occasions during the next 24 hours. Then add the liquid—which is colourless or pale yellow, transparent, and alkaline to litmus—to ordinary nutrient agar in the proportion of 1-3 of agar. A broth may be prepared with albumin in a similar manner.

Milk-agar.—Milk added to glycerin-agar constitutes a very good medium for the growth of the gonococcus (Bruschettini and Ansaldo).

Steinschneider's agar is prepared by mixing one part of human urine collected aseptically with two parts of sterile agar (the technique is the same as for Wertheim's agar).

Bumm's serum.—Bumm uses solidified human serum. The blood is collected with aseptic precautions during confinement.

Immediately after cutting the umbilical cord, the placenta being still in the uterus, wash the central end in corrosive sublimate solution, and allow the blood to flow into a sterile flask. In this way as much as 100 c.c. of blood can be collected and from the blood a perfectly clear serum can be drawn off 18-24 hours later which is then solidified in the ordinary way.

It is easier to use blood collected from a vein of the forearm (p. 193). The characteristics of the growth on human serum are the same as on Wertheim's agar.

De Christmas uses coagulated rabbit serum instead of human serum and cultivates the organism in tubes of small diameter.

Potato.—No growth takes place on potato. On glycerin-potato Bruschettini and Ansaldo obtained a good growth by sowing from a white-of-egg-broth culture.

SECTION III.—BIOLOGICAL PROPERTIES.

1. Viability. Virulence.

Gonorrhoeal pus is sterilized in a few minutes by heating at a temperature of 55° C. Similarly if kept at a temperature of 0° C. in an ice chest for a few hours cultures cannot be obtained on sowing the material. Desiccation and exposure to the air will rapidly sterilize gonococci in pus. The weakest antiseptics are sufficient to kill the organism.

The gonococcus has very little viability in cultures. If kept in the incubator the cultures may live 2 or 3 weeks but if kept at the ordinary temperature only a few hours. Successive sub-cultures soon become unfertile; as a rule sub-cultures fail to grow after the fourth or fifth generation, but on media containing albumin, Leipschutz succeeded in cultivating the organism for thirty-five generations.

Young cultures on suitable media are virulent but the virulence is soon lost. The lesions produced in animals by cultures are chiefly due to the toxin inoculated at the same time. The virulence of any strain of the organism may be increased by passage through rabbits (p. 635).

2. Toxin.

The toxin of the gonococcus was studied by De Christmas, and his results were confirmed by Wassermann and Nicolaysen. These observers found that the toxin is almost exclusively intra-cellular whence it diffuses only very slowly into the surrounding media. Morax and Elmassian obtained an active toxin by macerating gonococci in a 1 per cent. solution of potash for a week or 10 days.

Preparation of the toxin.—For the cultivation of the organism De Christmas at first used a mixture of one-third ascitic fluid and two-thirds peptone

broth; he now prefers a mixture of meat extract and ascitic fluid. After incubation the growth is filtered.

Macerate 500 grams of fresh minced veal for a few hours in a litre of warm water: add 2 or 3 grams of gelatin at will, but no salt. Heat to 105° C. for half an hour. Filter, concentrate to one-fourth its original volume and sterilize. To 25 parts of this mixture add 75 parts of ascitic fluid.

The gonococcus must be acclimatized to the medium by growing successively in broth containing one-fourth then one-half of its volume of ascitic fluid. After acclimatization the resistance and the toxigenic capacity of the organism increase. The medium should be sown with a young—2 or 3 days-old—culture on rabbit serum; the organism will remain alive in the liquid for 6 weeks.

Twelve hours after sowing the medium is cloudy and the surface is covered with a creamy pellicle; later the fluid becomes clear, the growth being deposited as a greyish viscous precipitate throwing out prolongations which float.

The toxin content is at its maximum after the culture has been incubating for 3–4 weeks at 37° C.

Properties.—The toxin has all the properties of the diastases. It is precipitated from filtered cultures by strong alcohol and sulphate of ammonium. It is soluble in glycerin. It can be heated to 65° C. for 15 minutes without undergoing any change, but between 65° and 75° C. its properties are altered and at 75°–80° C. it is soon destroyed. It does not dialyse through parchment.

The gonotoxin is very toxic to laboratory animals though they are immune to the gonococcus itself.

Sub-cutaneous or intra-peritoneal inoculation of 1–2 c.c. of the toxin will sometimes kill guinea-pigs though generally it is necessary to inoculate 5–10 c.c. of toxin intra-peritoneally to produce a fatal result in these animals. Sub-cutaneous inoculation in guinea-pigs and rabbits is followed by the formation of an abscess which soon becomes the seat of secondary infections. The injection of toxin into the pleural cavity of a rabbit produces a purulent but sterile effusion.

Gonotoxin injected intra-cerebrally in doses of 0.002 c.c. kills guinea-pigs in 4–6 hours. Smaller doses are not fatal but lead to a high degree of immunity so that the animal can resist further intra-cerebral inoculations. Large doses of toxin inoculated sub-cutaneously on several different occasions produce an immunity against intra-cerebral inoculation.

In man, a distinct urethritis is produced by injecting 2 c.c. of a 1 in 10 dilution of toxin into the fore part of the urethra and leaving it there for 2 or 3 minutes.

3. Serum therapy. Agglutination. Vaccination.

Goats which have been treated with large doses of gonotoxin inoculated into the sub-cutaneous cellular tissue yield an antitoxic serum (De Christmas).

A mixture of toxin and antitoxic serum is harmless. Neutralization does not occur immediately but takes 3–4 hours: at 15° C. one-half of a cubic centimetre of the serum neutralizes 10 c.c. of the toxin.

If injected alone into the brain before the toxin, the serum protects the animal for 3 days against an intra-cerebral inoculation of toxin, but if inoculated after the toxin it has neither prophylactic nor therapeutic properties.

Injected sub-cutaneously or into the veins or peritoneal cavity in large doses (1–5 c.c.) the serum has prophylactic properties provided that the inoculation of toxin be not made until after an interval of 48 hours.

Vannod also prepared a rabbit serum which had therapeutic properties against the gonococcus toxin and agglutinated the organism in dilutions of 1 in 200 to 1 in 400.

Rogers and Torrey immunized sheep by intra-peritoneal inoculation. Cultures heated to 65° C. for half an hour were used for the first inoculations, then living cultures. The serum agglutinated the organism and according

to these observers was of therapeutic value in gonorrhœal rheumatism and gonorrhœal infections of the genito-urinary tract in man.

The serum of guinea-pigs and rabbits immunized by intra-peritoneal inoculations of cultures of the gonococcus agglutinates old cultures of the gonococcus and also, but to a less extent, young cultures.

Bruckner and Christeanu after inoculating a horse on several occasions with cultures of the gonococcus obtained a powerfully agglutinating serum. This serum exhibited therapeutic properties against an intra-peritoneal inoculation in rabbits.

The serum of a person suffering from gonorrhœal prostatitis agglutinated an old culture but not a young culture (Wildbolz).

Normal human serum and normal guinea-pig serum did not possess agglutinating properties.

[**Human vaccine therapy.**—Vaccines prepared by Wright's method (p. 605) give distinctly encouraging results in the treatment of gonorrhœa and its complications. An autogenous vaccine must, of course, be used to obtain the most satisfactory results but while this is in preparation a "stock" vaccine—prepared from a laboratory strain—may be administered to avoid delay in the treatment. The initial dose should consist of five or ten million organisms and the amount inoculated on subsequent occasions must be determined by the extent of the local inflammation and by the degree of general malaise following each dose. It is important that a severe reaction be not excited.]

SECTION IV.—DETECTION AND ISOLATION OF THE GONOCOCCUS.

Pus from the urethra and from the various secondary suppurations should form the material for examination.

In collecting pus from the urethra, after cleansing the meatus squeeze the penis from the root to the glans, and aspirate the pus into a pipette or collect it on a platinum loop.

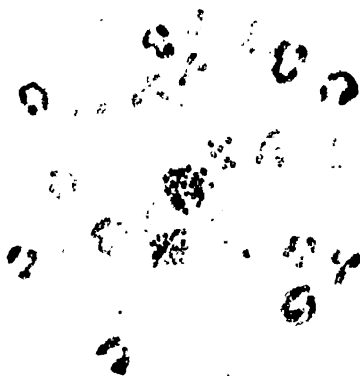

FIG. 303.—*Gonococcus* in pus from the urethra. Gram's stain and dilute carbol-fuchsin. (Oc. 2, obj. $\frac{1}{4}$ th, Zeiss.)

(a) **Microscopical examination.**—In making film preparations the cover-glasses should not be pressed together too firmly and should be slid apart gently so that the pus cells are not broken: if the films be treated roughly

the gonococci will be set free, and one of the characteristic appearances lost. The film should be stained by methods which will differentiate the gonococcus from other organisms likely to be found with it.

In medico-legal cases it sometimes happens that pus dried on linen has to be examined for the gonococcus. Heger-Gilbert recommends that in such circumstances the material should be dealt with as follows :

Cut out the piece of linen on which the pus has dried and lay it in a watch-glass on a piece of filter paper which has been thoroughly saturated with slightly alkaline normal saline solution. Cover with another watch-glass and leave for 1-5 hours. Then apply the fine end of a pipette to the different parts of the linen and aspirate gently. The formed elements in the pus are thus sucked up with a little fluid into the pipette. Spread the fluid collected in the pipette on a slide, dry and stain as already directed (*vide ante*).

(b) **Cultures.**—To isolate the gonococcus in culture the pus should be collected during the first few days of the disease ; later, infection of the urethra with other organisms will complicate the technique. It is best to sow stroke cultures on plates of serum-agar or blood-agar and to aim at getting isolated colonies.

Note.—In chronic gonorrhœa, when the discharge is reduced to a mere drop, the best method of finding the gonococcus is to instruct the patient to pass his urine on waking into a conical vessel, and to let it stand, adding a crystal of thymol as an antiseptic. In a short time whitish threads of mucus or muco-pus are deposited at the bottom of the vessel. Aspirate the deposit with a pipette and prepare films as already described. This method cannot be applied to the isolation of the gonococcus, and if it be necessary to obtain cultures the urine must be collected in a sterile manner in a sterile vessel, and a thread at once removed with a sterile pipette and sown on serum-agar. It is sometimes useful to centrifuge the urine and examine the deposit for the gonococcus.

In cases of gonorrhœa of old standing when the pus contains very few gonococci it often happens that the latter cannot be found. Neisser has shown that a local or general stimulant, *e.g.* an injection of nitrate of silver locally or the consumption of beer, leads in such cases to an increase in the amount of pus, and in this it may be possible to detect the gonococcus.

CHAPTER XLVII.

THE MENINGOCOCCUS.

Introduction.

Section I.—Experimental inoculation, p. 645.

Section II.—Morphology, p. 645.

1. Microscopical appearance and staining reactions, p. 645. 2. Cultural characteristics, p. 647.

Section III.—Biological properties, p. 647.

1. Bio-chemical reactions, p. 647. 2. Vitality and virulence, p. 648. 3. Toxins, p. 648. 4. Immunization and serum therapy, p. 648. 5. Agglutination, p. 649.

Section IV.—The isolation and identification of the meningococcus, p. 650.

1. The diagnosis of meningococcal meningitis, p. 650. 2. The isolation of the organism, p. 650.

Micrococcus catarrhalis, p. 651.

EPIDEMIC cerebro-spinal meningitis¹ is generally caused by the *Diplococcus intra-cellularis meningitidis* discovered by Weichselbaum and now generally known as the *Meningococcus*.

Though the Meningococcus is the most frequent cause of the disease (especially in recent epidemics) it is of course not the only cause of epidemic meningitis.

In some cases of epidemic meningitis a typical pneumococcus has been recovered from the cerebro-spinal fluid (Wolf, Netter and others), and Marchoux described an epidemic of cerebro-spinal meningitis in Senegal which was due to the pneumococcus.

In another epidemic of cerebro-spinal meningitis Jæger and Heubner found an organism quite distinct from the Meningococcus (p. 626). Bonome, again, described an encapsulated gram-positive streptococcus as the cause of an epidemic of cerebro-spinal meningitis: this organism has also been demonstrated in a large number of cases of meningitis, particularly by Netter: it is commonly found in association with the Meningococcus.

The Meningococcus is present in the cerebro-spinal fluid and in the fluid exudate on the meninges in cases of meningitis: it occasionally enters the blood stream (Salomon, Elser, Sacquépée, etc.). It has been shown that meningococcal cerebro-spinal meningitis is always preceded by a more or less well marked naso-pharyngitis, with symptoms of sore throat and coryza, due to infection with the meningococcus (Strümpell, Weigert, Albrecht and Ghon, Kiefer, Jundell, etc.). According to Ostermann it is this naso-pharyngitis which is contagious and disseminates the meningococcus. Some individuals affected with pharyngitis escape an attack of meningitis, which only supervenes when the organism—under conditions still little understood—passes from the naso-

¹The expression "epidemic meningitis" is very commonly used to connote meningococcal meningitis. Such a limitation of the meaning is, of course, very misleading.]

pharynx to the meninges. During an epidemic of meningococcal cerebro-spinal meningitis it is therefore a matter of great importance that the naso-pharynx of contacts should be examined for the presence of the Meningococcus: a person may carry the organism in his naso-pharynx and spread the infection while himself remaining in apparently good health. Indeed Bruns and Hohn venture the opinion that there are ten to twenty times more carriers of the Meningococcus than cases of meningitis. On an average the Meningococcus remains in the pharynx of a "carrier" for about a fortnight, though it may persist for several months.

Meningococcus and Gonococcus.—Many observers have drawn attention to the close resemblance which exists between the Meningococcus and the Gonococcus, *e.g.* their microscopical appearances, reaction to Gram's stain, intra-cellular position within the leucocytes and agglutination by the same specific serums.

It has however been shown that these two organisms though they belong to the same group are nevertheless two sharply differentiated species: the Meningococcus is pathogenic for mice while the Gonococcus is not, and the cultural characteristics of the two cocci are different: Zupnik by inoculating cultures of the second generation of the Meningococcus into the urethra of five medical men in good health failed in every case to produce symptoms of gonorrhœa, while if a gonococcus even of the twentieth generation be similarly inoculated symptoms of gonorrhœa follow. Finally the two organisms can be shown to be different species by a study of the agglutination and complement fixation reactions.

SECTION I.—EXPERIMENTAL INOCULATION.

The virulence of the Meningococcus is subject to considerable variation but in any case it is only slightly pathogenic for laboratory animals

Mice are the most susceptible animals: they generally succumb after intra-peritoneal inoculation of a large dose of culture. *Post mortem* examination reveals a condition of peritonitis, and in the exudate the micro-organisms will be found to be present in very large numbers; the spleen and the heart blood contain very few.

Rabbits and especially guinea-pigs are less susceptible: they only succumb after the inoculation, intra-peritoneally or intra-venously, of very large doses of cultures. In these animals metastatic deposits do not occur and the organism does not multiply; death results from intoxication (Weichselbaum, Jundell). In mice on the other hand some slight degree of multiplication seems to take place but successive passages never lead to any increase in virulence (Bettencourt and França).

Inoculation into the meninges of laboratory animals does not lead to symptoms of meningitis (Weichselbaum, Albrecht and Ghon). But in monkeys, Flexner produced a true meningitis fatal in 24 hours by inoculating the Meningococcus beneath the arachnoid: *post mortem* the lesions typical of cerebro-spinal meningitis were found.

SECTION II.—MORPHOLOGY.

1. Microscopical appearance.

In meningeal exudates and in the cerebro-spinal fluid the Meningococcus generally occurs as a diplococcus. The elements composing the diplococcus resemble coffee beans, the flattened surfaces being opposed to each other. The micro-organism is very similar to the Gonococcus in appearance: not

infrequently two diplococci are seen arranged as tetrads. Isolated individuals are round and of variable size: chains are never seen. Most of the organisms are contained within the leucocytes, some of the latter being crowded with cocci.

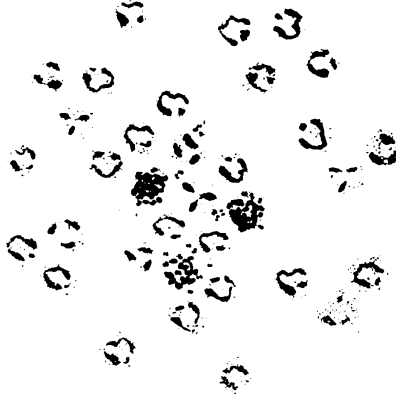

FIG. 304.—Meningococcal exudate. Jenner's stain. (Oc. 2, obj. $\frac{1}{2}$ th. Zeiss.)

In the cerebro-spinal fluid and in meningeal exudates the Meningococcus is rarely encapsulated, but exceptionally individuals show a very distinct membrane. In cultures on rabbit serum the capsules are very apparent.

In cultures, as in pathological exudates, the cocci may occur singly, or in pairs, or as very distinct tetrads: they are frequently found in small agglutinated clumps: chains have never been observed.¹

Staining reactions.—The Meningococcus is readily stained by the basic aniline dyes; carbol-blue and carbol-thionin are especially useful.

The organism is gram-negative.

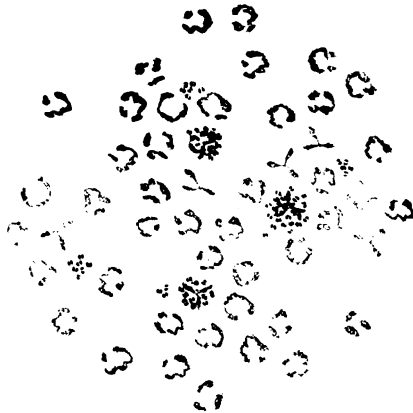

FIG. 305.—Meningococcal exudate. Gram's stain and eosin. (Oc. 2, obj. $\frac{1}{2}$ th. Zeiss.)

Schottmüller examined 43 strains and found that they were all decolourized by Gram's method even after being sub-cultivated many times. But according to

¹ The Jæger-Heubner diplococcus, on the other hand, forms long chains in liquid media.

Lehmann it is not uncommon to find gram-positive individuals in preparations of the *Meningococcus*.

2. Cultural characteristics.

Conditions of growth.—The *Meningococcus* is a strict aërobie. Growth will only take place at temperatures between 25° C. and 42° C., the optimum temperature being 37° C. In attempting to isolate the organism it may be difficult at first to obtain cultures, but once established growth takes place quite well on the ordinary media. Media which contain blood or serum (such as human-blood-agar, ascitic-agar and liquid rabbit serum) are particularly useful, and should be employed for the primary cultures.

Characters of growth. Agar.—When large quantities of pus rich in meningococci are sown on agar a small number of colonies appear. In 24 hours these attain a diameter of 2 mm., are raised—with the surface flattened and borders rounded—greyish, and at first transparent subsequently becoming opaque in the centre.

Blood-agar. Ascitic-agar.—Early sub-cultures give isolated colonies having the same characteristics as those on agar, but after several sub-cultures the colonies become confluent and form a copious greyish deposit with wavy edges.

Kutscher recommends agar made with placenta. Macerate a chopped-up placenta in twice its weight of water, and to each 100 parts of maceration add 2.5 parts agar, 0.5 parts salt, 1 part glucose, 2 parts peptone (Chapoteaut). Prepare as for ordinary agar, make slightly alkaline and to 3 parts of the product mix 1 part of ox serum previously heated to 60° C.

Broth.—In early sub-cultures either no growth occurs, or it may be a very minimal amount insufficient to render the medium cloudy, a few coherent masses and a little deposit being found. When acclimatized the cultures may become more abundant and assume the same characteristics as in serum broth.

Serum-broth. Ascitic-broth.—Coherent masses are first seen and then towards the third day a greyish, thin, delicate film appears.

Rabbit serum.—A slight cloudiness with formation of coherent masses.

Milk is not coagulated by the growth of the organism.

Potato.—Very fine, greyish deposit.

SECTION III.—BIOLOGICAL PROPERTIES.

1. Biochemical reactions.

The *Meningococcus* ferments glucose and maltose, but has no action on levulose, saccharose and inulin.

Media containing glucose and maltose.—If to media containing glucose or maltose litmus solution or neutral red be added to serve as indicators, such media can be used for the diagnosis of the *Meningococcus*.

The *Meningococcus* forms acid out of glucose and maltose and turns the litmus red. To tubes of lactose agar add one-third its volume of ascitic fluid (p. 53) and about 1 c.c. of litmus solution and set in the sloped position.

Buchanan recommends Loeffler's serum-broth containing 1 per cent. glucose and 0.01 per cent. of a 1 per cent. solution of neutral red. This medium at first of a yellowish colour is turned pink in about 24 hours by the *Meningococcus*. Sloped tubes of lactose-ascitic-agar containing a trace of neutral red may also be used.

The meningococcus produces no indol.

2. Vitality and virulence.

Vitality.—At room temperature cultures die in from 4–6 days : in the ice chest they become sterile in 36–48 hours. In early sub-cultures the Meningococcus dies in 3–6 days, but after being resown several times the organism may live in the incubator for as long as 3 months (Albrecht and Ghon).

Cultures are sterilized in 5 minutes at 65° C., in a few minutes at 80° C. and instantly at 100° C. : and are also sterilized by desiccation for 3 hours at 20° C.

Virulence.—The virulence of the Meningococcus is very inconstant, different strains presenting varying degrees of pathogenicity, and it does not appear to be increased by passage through animals.

The severity of the symptoms produced in the human subject by a given strain of Meningococcus bears no relation to the virulence of that strain for the lower animals.

On account of the considerable variation in the virulence of different strains of Meningococci most observers use strains from several sources in immunizing animals for the preparation of antimeningococcal serum.

3. Toxins.

Cultures of the Meningococcus sterilized by heat kill susceptible animals as easily as living cultures. Filtered cultures have no toxic properties (Jundell, Albrecht and Ghon). Flexner has shown that an emulsion of Meningococci sterilized with toluol and filtered to remove the bacteria is toxic.

Dopter from his experiments concludes that the toxin is an endotoxin and that the Meningococcus secretes no soluble toxins. The toxin can be extracted by autolysis by treating the bacteria with distilled water : solutions prepared in this way are often used for immunizing animals and preparing anti-meningococcal serum (*vide infra*).

4. Immunization. Serum therapy.

Ruppel immunizes rabbits by inoculating them sub-cutaneously first with a non-virulent strain then with a strain known to be of high and constant virulence. The serum of these animals has prophylactic properties (0.004 c.c. protects against 100 lethal doses). Ruppel's investigations led Flexner, and then other bacteriologists, to attempt the immunization of horses for the purpose of preparing a therapeutic serum : the various methods which have been employed will be considered under three heads.

A. Flexner immunizes horses by inoculating them sub-cutaneously first with dead cultures, then with living cultures, and finally with an autolytic extract obtained by making an emulsion of virulent cultures in water. (Flexner in his earlier experiments inoculated the horses intra-venously but this method was abandoned in favour of sub-cutaneous inoculation.)

B. Kolle, Wassermann and Leber immunize three horses simultaneously.

One is inoculated with cultures of a single strain of the Meningococcus. The first inoculation given sub-cutaneously consists of one-half a 24-hour agar culture made into an emulsion with normal saline solution and heated to 60° C. : the second of a whole culture similarly treated : the third of one-half a living non-heated culture and the fourth of a whole non-heated culture. Afterwards the horse is inoculated intra-venously on successive occasions with one-half, one, two, three, and four living cultures.

A second horse is treated in a similar manner but with a mixture of 5 or 6 strains of Meningococci from different sources.

The third horse is inoculated with toxins. Young agar cultures in Roux bottles are washed off with sterile distilled water, shaken for 48 hours, 0.5 per cent. carbolic acid added and the whole centrifuged. The supernatant liquid is toxic for guinea-pigs in doses varying from 0.1–1 c.c. intra-peritoneally. The first inoculation for the horse is a quantity equivalent to 10 times the fatal dose for a guinea-pig. The horse is treated for a long time with sub-cutaneous inoculations of the toxic extracts and afterwards by intra-venous inoculation; great care has to be exercised in inoculating these extracts since symptoms of anaphylaxis are not at all uncommon.

The serum of the three horses is mixed in equal parts for therapeutic purposes.

C. Dopter immunizes horses solely by means of living cultures which are inoculated first sub-cutaneously and later intra-venously.

Properties of anti-meningococcal serum.—The serums of animals immunized by any of the above methods exhibit agglutinating, sensitizing, opsonizing and precipitating properties. They possess undoubted therapeutic properties in meningococcal cerebro-spinal meningitis but in no other forms of meningitis.

Therapeutics.—In meningococcal meningitis the serum should be inoculated into the sub-arachnoidal space. Lumbar puncture is first performed and a quantity of fluid let out equal to or rather greater than the volume of serum to be inoculated: then, without withdrawing the needle a fairly large dose of serum is inoculated slowly (20–40 c.c. for an adult, 15–20 c.c. for a young child). The inoculation must be repeated twice, three times and even four times at intervals of a few days, indications for the further use of the serum being shown by the clinical symptoms and more especially by the appearance of the cerebro-spinal fluid. When the latter becomes clear and limpid, and the Meningococci have disappeared, and the pus cells are replaced by normal poly-morpho-nuclear leucocytes or lymphocytes, no further administration of serum is needed.

5. Agglutination.

The serum of persons suffering from meningococcal meningitis generally agglutinates the Meningococcus in a dilution of 1 in 100 (Albrecht and Ghon: Bettencourt and França). The agglutination would appear to be better marked with the strain isolated from the patient than with strains recovered from other sources (1 in 50). Antimeningococcal serum also agglutinates the Meningococcus in dilutions of 1 in 200, 1 in 500 and even 1 in 1000.

Note.—The examination of the agglutination reaction is open to two sources of error.

I. The Meningococcus is not always agglutinated by specific serums. And Kutscher observed that some strains never agglutinate at a temperature of 37° C., but agglutinate very well when left at 55° C. for 24 hours: it is advisable therefore when an organism has been isolated having the morphological appearances of the Meningococcus but which does not agglutinate with a specific serum at 37° C. to test the reaction at 55° C.

II. Some closely related organisms are agglutinated by an antimeningococcal serum. The Gonococcus is an interesting case in point. An antimeningococcal serum will agglutinate both the Meningococcus and—though more feebly—the Gonococcus, and conversely an antigonococcal serum will agglutinate the Meningococcus as well as the Gonococcus. Dopter and Koch have however shown that if an emulsion of the Meningococcus be added to an antimeningococcal serum it will absorb the whole of the agglutinin while absorption with the Gonococcus will not remove the agglutinin for the Meningococcus: if on the other hand an emulsion of the Gonococcus be added to an antimeningococcal serum, and after the organism is agglutinated the mixture be centrifuged, the clear supernatant fluid will agglutinate the Meningococcus but will have no such action upon the Gonococcus. The antimeningococcal serum therefore contains specific agglutinins for the Meningococcus and group agglutinins which act alike on the Meningococcus and on the Gonococcus.

This experiment which demonstrates differences of a specific nature between the

Gonococcus and Meningococcus is further confirmed by the fact that antigonococcal serum contains no immune body (*sensibilisatrice*) for the Meningococcus and conversely (Vannod).

The agglutination reaction.—For the diagnosis of the Meningococcus the agglutination reaction should be carried out as follows :—

1. Take five narrow sterile test-tubes.
2. To the first add 1 c.c. of a 1 in 100 dilution of unheated antimeningococcal serum. To the second 1 c.c. of a 1 in 200 dilution of the same serum. To the third 1 c.c. of a 1 in 100 dilution of normal horse serum. To the fourth 1 c.c. of a 1 in 200 dilution of normal horse serum. To the fifth 1 c.c. of normal saline solution.
3. To each tube add one loopful of a young agar culture of the organism under investigation.
4. Incubate the tubes at 37° C. for 24 hours. (If no agglutination has taken place repeat the experiment and incubate at 55° C.)
5. If the organism be a Meningococcus, on taking the tubes out of the incubator there will be very distinct agglutination in tubes Nos. 1 and 2 while the emulsion in the other three tubes will be cloudy.

SECTION IV.—THE ISOLATION AND IDENTIFICATION OF THE MENINGOCOCCUS.

1. **The diagnosis of meningococcal meningitis.**—The diagnosis of meningococcal meningitis should be based upon the following characteristics of the organism isolated.

1. Microscopical appearance : “ coffee bean ” diplococci situated, in the case of meningeal exudates, within the leucocytes.
2. Staining reactions : gram-negative.
3. Cultural characteristics : capacity to grow on ordinary agar : fermentation of glucose and maltose, no action on lævulose and saccharose.
4. Agglutination by a specific serum.

2. **The isolation of the organism.**—The cerebro-spinal fluid and also the exudate on the naso-pharynx should be examined.

A. Cerebro-spinal fluid.—To establish a diagnosis of meningococcal meningitis it is essential to examine the fluid obtained by lumbar puncture.

In cases of this disease the cerebro-spinal fluid is generally purulent or cloudy : but this indication, though present according to Netter in 96 per cent. of cases, is not pathognomonic. In the early stages of the infection (during the first 24 hours) the cerebro-spinal fluid is clear and it may again become clear later, towards the end of the second week.

Centrifuge the cerebro-spinal fluid in a sterile tube and then proceed as follows :

1. Examine a portion of the deposit microscopically. Stain a film with a simple stain and another by Gram's method.
2. Sow the remainder of the deposit on blood-agar or ascitic-agar and incubate for 24 hours at 37° C. Examine the colonies and sow some on glucose and on maltose tinted with litmus or neutral red (*vide ante*) and use others for the agglutination reaction.

Vincent and Bellot's reaction.—Centrifuge the cerebro-spinal fluid immediately after collection. Drop 50–100 drops of the clear supernatant fluid into each of two sterile tubes : to one tube add 1 or 2 drops of antimeningococcal serum and incubate for 6–12 hours at 37° C. or 55° C. If the case be one of meningococcal meningitis the tube to which the antimeningococcal serum has been added is slightly cloudy while the control tube remains clear.

The reaction sometimes fails; and occasionally both tubes are cloudy when it is of course valueless. But in general it is a useful test especially when meningococci are not found in the cerebro-spinal fluid.

Note.—In a certain number of cases (25 per cent. according to von Lingelsheim) no organism can be detected in the cerebro-spinal fluid though they can be proved to be cases of meningococcal meningitis by examining the agglutinating properties of the blood and by Vincent and Bellot's reaction: and it must be assumed either that the organism was present in the early stages of the disease and has vanished or that it is confined to the upper part of the cerebro-spinal axis.

B. Naso-pharyngeal exudates.—The material must be collected from the naso-pharynx from behind the fold of the palate. A small plug of sterile wool fixed on a rigid metal wire and slightly curved at the end may be used to collect the exudate: pass this wool plug as high as possible behind the palate and sow the material without delay on ascitic-agar plates. Incubate for 24 hours at 37° C. and carefully examine the colonies: any that look suspicious must be tested as described above. Confusion is most likely to arise with the *Micrococcus catarrhalis* (*vide infra*); this organism however grows easily on all the ordinary media and does not ferment either glucose or maltose.

Micrococcus catarrhalis.

In recent years German writers have described the occurrence in some respiratory affections of a gram-negative organism morphologically similar to the Gonococcus and which they designate the *Micrococcus catarrhalis* (Ghon, Pfeiffer, Bezançon, Israël and de Jong).

This organism is frequently found in man in cases of bronchitis and pneumonia, and in the sputum of tuberculous persons whose temperature is raised. Some writers have confused the *Micrococcus catarrhalis* with the Meningococcus, but it is easily differentiated from the latter by its cultural characteristics.

The *Micrococcus catarrhalis* grows well on ordinary media: does not ferment carbohydrates: and is not agglutinated by an antimeningococcal serum.

Experimental inoculation.—The *Micrococcus catarrhalis* is only slightly virulent for laboratory animals. It gives rise to small lesions of the pleura when inoculated in very large doses into the pleural cavities of guinea-pigs or mice: rabbits are not susceptible.

Microscopical appearance.—In sputum the organism is seen as irregular diplococci, looking like coffee beans placed in pairs with their flattened surfaces adjacent. They may be seen singly or in small groups, either free or within the leucocytes. In cultures the appearance is much the same. The diplococci are sometimes arranged in tetrads but more frequently in small clumps. Chains are never seen and the organism is not surrounded by a capsule.

The *Micrococcus catarrhalis* is easily stained by the basic aniline dyes and is gram-negative.

Cultural characteristics.—The organism is aerobic and grows at 20° C. but the optimum temperature is 37° C.

Gelatin.—A slow and scanty growth takes place at 20° C. The medium is not liquefied.

Broth.—In broth at 37° C. a slight cloudiness and powdery deposit is formed.

Agar.—After 24 hours' incubation at 37° C. the growth consists of small, white, irregularly rounded colonies. Later the centre becomes prominent and slightly brownish in colour while the margins are wavy and jagged.

Liquid rabbit serum.—The growth is minimal on this medium and the organism is not capsulated.

Milk.—The medium is not coagulated as the result of the growth of the organism.

Carbohydrate media.—No fermentation.

PART III.
THE PARASITIC FUNGI.

CHAPTER XLVIII.

THE PARASITIC HYPOMYCETES.

Section I.—The genus *Discomyces*, p. 655.

I. *Discomyces bovis*, p. 656.

The parasites of actinomycosis, p. 660.

II. *Discomyces israeli*, p. 661. III. *Discomyces thibiergi*, p. 661. IV. *Discomyces liquefaciens*, p. 661. V. *Discomyces garteni*, p. 661. VI. *Discomyces asteroides*, p. 662. VII. *Discomyces fürsteri*, p. 662. VIII. *Discomyces rosenbachi*, p. 662. IX. *Discomyces maduræ*, p. 662. X. *Discomyces freeri*, p. 664. XI. *Discomyces brasiliensis*, p. 665.

The parasites of mycetoma, p. 665.

XII. *Discomyces minutissimus*, p. 666. XIII. *Discomyces farcinicus*, p. 667. XIV. *Discomyces capræ*, p. 668. XV. *Discomyces hofmanni*, p. 669. XVI. *The polychrome discomyces of Vallée*, p. 669.

Section II.—The genus *Malassezia*, p. 669.

1. *Malassezia furfur*, p. 669. 2. *Malassezia tropica*, p. 670. 3. *Malassezia macfadyeni*, p. 670. 4. *Malassezia mansonii*, p. 670.

Section III.—The genus *Trichosporum*, p. 670.

Section IV.—The genus *Coccidioides*, p. 671.

Section V.—The genus *Sporotrichum*, p. 672.

Section VI.—The genus *Oidium*, p. 674.

Section VII.—A fungus of unknown classification: the parasite of Bursattee, p. 674.

SECTION I.—THE GENUS DISCOMYCES.

Parasites of the genus *Discomyces*—*Streptothrix* (Cohn)—were formerly grouped with the Bacteria, but Sauvageau and Radais have shown that they really belong to the family of the *Oosporidæ* of the *Hypomycetes*. The parasitic species of the *Discomyces* which produce disease in man and the lower animals do not however appear, as was thought, to belong to the genus *Oospora*, and the majority of observers now agree that it is better to accept Blanchard's classification and to group them among the *Oosporidæ*, but with the generic name *Discomyces* (Rivolta).

The *Oosporidæ* are fungi consisting of a branched septate mycelium—the mycelium was for long considered to be non-septate but Gueguen has shown that it is in fact septate—and in which reproduction takes place by rows of rounded conidia.

It is not uncommon to find parasites belonging to the *Oosporidæ* in the mouth, where they may be responsible for white patches, ulcers and abscesses in the tonsil (Roger, Bory and Sartory). In the sputum of persons suffering from various pulmonary diseases both Roger and Flexner have found similar parasites.

The various species of the genus *Discomyces* possess certain characteristics in common. They grow readily in artificial culture media, and in liquid media give rise to a growth somewhat resembling the leaves of the water lily; the medium

never becomes cloudy. On gelatin they form small, spherical, star-like colonies; their growth on potato consists of hard, dry, scaly masses. The appearance of a culture however and also the colour vary to some extent with the different species and with age. In old cultures on solid media numerous aërial hyphæ bearing chains of conidia project from the surface: during germination the envelope of the spore bursts, and from it there originates a young filament which in turn ramifies. Reproduction may also take place by transverse division of the filaments. So that according to the age of the culture, microscopical examination may show branched forms, streptococcal-like chains, or small filaments closely resembling the avian tubercle bacillus. In view of this apparent pleomorphism it is not surprising that observers were for a long time led astray in their investigations into the nature and identity of these parasites.

Organisms of the genus *Discomyces* stain in a manner similar to that of the tubercle bacillus.

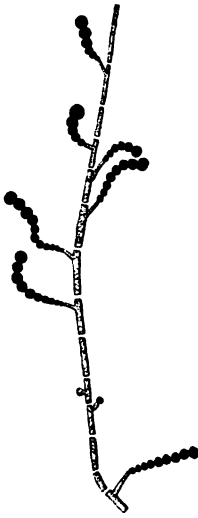

FIG. 308.—Fructification of an *Oospora*. (After Sabouraud.)

I. DISCOMYCES BOVIS. (Hartz; R. Blanchard.)

Syn. *Actinomyces bovis* Bollinger and Hartz.—*Oospora bovis* Sauvageau and Radais.—*Nocardia actinomyces* Trevisan.—[*Streptothrix actinomyces* Rossi Doria.]

That cattle were subject to a peculiar disease characterized by the formation of large, hard, sarcomatous masses in the tongue and jaw bones which had a tendency to break down and become purulent had for a long time been recognized, but the cause of this disease was unknown until Bollinger and Hartz showed that it was due to a specific parasite, to which they gave the name *Actinomyces bovis*. Shortly afterwards Israël and Wolff found the same organism in the pus of an empyema in the human subject. Since then a very considerable number of cases of Actinomycosis in man have been recorded, and the disease can no longer be regarded as a pathological curiosity.

Infection with the parasite in man, as in cattle, may take the form of a swelling of the jaw bone, but lesions localized in other tissues of the body and even generalized infections are frequently seen, and may so closely resemble tuberculosis as to be confounded with that disease. Infection of the lung (broncho-pneumonia, pleurisy) and of the peritoneum is not uncommon. It is a difficult matter to diagnose the disease on clinical evidence alone so that a microscopical examination of the pus, sputum, etc. is of great assistance.

Actinomycosis occurs also in animals other than cattle: it has been found in pigs, deer, sheep, horses, elephants, and other animals.

Outside the body *Discomyces bovis* lives as a saprophyte on cereals, and infection of cattle is thus easily accounted for. Man may become infected by handling corn or by inhaling dust during threshing operations. Delearde produced an osteosarcoma in the maxilla of a sheep by inoculating the bone beneath the periosteum with a grain of barley infected with the parasite.

1. Experimental inoculation.

The earlier experiments made with cultures grown aërobically failed to infect the inoculated animals (Boström). Israël and Wolff, however, were able to infect rabbits by inoculating them with cultures grown anaërobically [vide *D. Israëli*]. Mertens inoculated a rabbit in the anterior chamber of the eye and produced nodules containing clubbed forms of the parasite.

Inoculations with pus from foci of actinomycosis in man have often given positive results in guinea-pigs, rabbits and cows (Israël and others). Rabbits die several months after being inoculated sub-cutaneously or intra-peritone-

ally; in the latter case masses of growth due to the parasite are found *post mortem* in the peritoneum, omentum and mesentery.

2. Morphology. Detection of the parasite.

A. Microscopical appearance.

1. **In the tissues.**—In cases of actinomycosis the pus, sputum, or other infected tissues contain sulphur coloured or occasionally whitish opaque grains, varying in size from a lycopodium spore to a millet seed. It is these grains which must be searched for and examined in a suspected case of actinomycosis, and it is very important that the pus or other material should be quite fresh, as the parasite rapidly degenerates. If the grains be scarce and very small it is best to spread a little of the pus in a thin layer on a slide, in this way the grains can easily be seen and collected for further investigation.

If one of the grains be crushed between a slide and cover-glass in a drop of glycerin the parasite can be readily and easily recognized (fig. 307). When

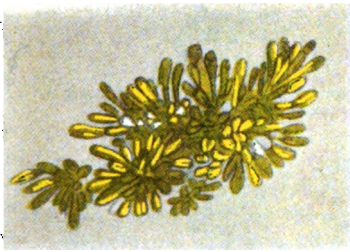

FIG. 307.—An actinomycosis grain. Unstained preparation obtained by crushing between two slides.

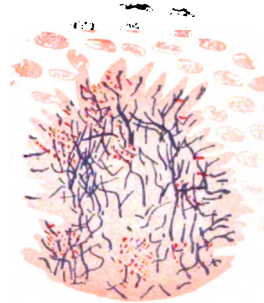

FIG. 308.—Section through an actinomycotic tubercle. Gram's method. (Oc. II, obj. 8, Reich.)

crushed in this way the grain will be seen to consist of small mulberry-like bodies composed of a central mass of filaments closely fitted together with numerous diverging rays (*ákris* = a ray) in many cases club-shaped at the free end (*yellow colonies, clubs, cross-forms*) (*vile infra*).

The central part consists of a tangled mass of *filaments* which appear to be branched, mixed with small swollen corpuscles: here and there a few filaments will be seen to project from the centre and end externally by the side of the clubs: the filaments measure on an average 10–12 μ long, the clubs 20–30 μ long by 8–10 μ broad. The *clubs* are merely degenerated forms of the parasite, the result of the cellular reaction of the tissues; the wall of the filament enlarges at the end, thus giving origin to a swelling or club, in the centre of which the original filament can be recognized. Clubs are at first oval in shape, but later degenerate and assume an irregular outline and frequently undergo calcareous degeneration. Clubs are not present in early lesions, and only occur when the tissues of the host are markedly resistant; often indeed when the lesions caused by the parasite are healing the filaments disappear, and only clubs are found.

In the tissues there is an accumulation around the parasite of epithelioid cells with large oval nuclei. These cells are arranged in a circle and may fuse to form a giant cell containing in addition to several nuclei the parasite itself.

Staining reactions.—The filaments of *Discomyces bovis* stain with the basic aniline dyes as well as by Gram's and Ziehl's methods, but they are not as

resistant to the decolourizing action of acid as the tubercle bacillus. The clubs stain with picrocarmine, safranin or eosin. A fresh specimen stained with picrocarmine shows the clubs detached and stained yellow on a pink background of cells.

Colonies crushed between slides may be stained, after drying and fixing in alcohol-ether, by Gram's method and counter-stained with eosin. The filaments will be stained violet and the clubs yellow or pink (fig. 308). Sections may be stained in the same manner. Weigert's method may also be used.

Equally pretty preparations may be obtained by staining sections for 30-50 minutes in carbol-fuchsin, decolourizing rapidly in 1 per cent. sulphuric acid, washing in alcohol, then in water, and counterstaining with an aqueous solution of methylene blue.



FIG. 309.—*Discomyces bovis*. Section through a bovine lesion. Carbol-fuchsin and methylene blue. (Oc. 2, obj. 1/4th, Zeiss.)

Morel and Dulaus recommend the following technique for sections: Stain for a few minutes in Delafield's hæmatoxylin (acetic acid is added until the solution has a red tint). Wash in water. Treat for 3 minutes in the following solution:—

| | | | | | | | | |
|----------------|---|---|---|---|---|---|---|---------|
| Victoria blue, | - | - | - | - | - | - | - | 1 gram. |
| Alcohol, | - | - | - | - | - | - | - | 10 c.c. |
| Water, | - | - | - | - | - | - | - | 90 " |

Wash again. Treat with Gram's solution for a few moments. Wash in alcohol. Stain for a few minutes in:—

| | | | | | | | | |
|-----------------|---|---|---|---|---|---|---|---------|
| Rosalin-violet, | - | - | - | - | - | - | - | 1 gram. |
| Alcohol, | - | - | - | - | - | - | - | 10 c.c. |
| Water, | - | - | - | - | - | - | - | 90 " |

Wash in water again. Pass rapidly through absolute alcohol. Decolourize very rapidly in a mixture of equal parts of essence of cinnamon and absolute alcohol. When the sections have acquired a red colour wash in alcohol, clear in xylol and mount in balsam. The nuclei of the cells are violet, the mycelium of the parasite blue, the clubs bright red.

For staining pus when no yellow grains can be found with the naked eye, Lemièrre and Bécue recommend the following method: 1. Spread a little of the pus on a slide, dry and wash in ether. 2. Treat for a few minutes with a 30 per cent. solution of soda. 3. Stain for a quarter of an hour in a 5 per cent. aqueous solution of eosin. 4. Wash in a saturated aqueous solution of sodium acetate and examine the preparation in this solution. The centres of the colonies are red, the clubs pale yellowish-pink.

2. In cultures.—The appearance of the parasite in cultures is quite different from its appearance in the tissues. Branched filaments, coccal forms and short rods are found, but no clubs are seen. In young cultures the mycelium

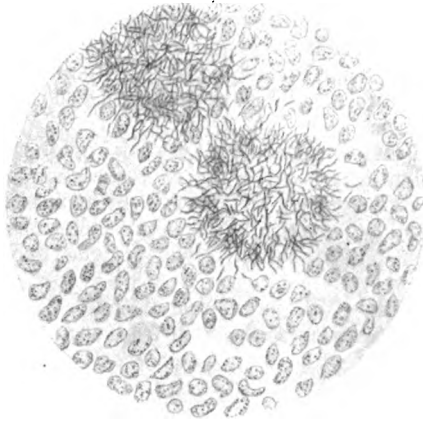

FIG. 310.—*Discomyces bovis*. Section through an human lesion. Gram's stain and eosin. (Oc. 2, obj. $\frac{1}{17}$ th, Zeiss.)

consists of delicate, branched, non-septate filaments which are sometimes very long. In older cultures these filaments divide into short stout rods (bacillary and coccal forms); the aërial hyphæ are thick and carry chains of conidia. In very old cultures, swollen and irregular-shaped involution forms are found.

B. Cultural characteristics.

Conditions of growth.—*Discomyces bovis* grows equally well under aërobic or anaërobic conditions. Growth commences at 20° C. is most luxuriant at 37° C., less abundant at 40° C., but still continues up to about 50° C. Most of the ordinary media are suitable for the cultivation of the parasite, the best growths however are obtained on serum and on media containing glycerin.

Some difficulty is often experienced in isolating the parasite from pus because in most cases it is associated with the ordinary organisms of suppuration, and these grow over the culture medium before the discomyces has had time to start. There are several methods of isolation, the most satisfactory being that described by Boström.

Spread the pus containing the yellow grains on plates of gelatin and incubate for a couple of days. On then examining the plates most of the grains will be surrounded by colonies of contaminating organisms but a few will be seen here and there which are more or less discrete and isolated. Pick these off with a stout platinum wire and transfer them to tubes of coagulated serum and incubate the cultures at 37° C. After 5–6 days the colonies of discomyces begin to grow. If this method be adopted it is advisable to sow a good number of tubes of serum because many of them will ultimately prove to be contaminated.

Culture media. Glycerin-broth.—When sown and incubated at 37° C. white, granular, hemispherical colonies appear in about 5 or 6 days and may grow as large as a pea. The colonies fall to the bottom of the tube leaving the medium quite clear.

Coagulated serum.—After being incubated for about 5 days, small whitish or yellowish colonies appear, dry, firm, and often confluent.

Glycerin-agar.—Growth appears after 2 days and takes the form of small, yellowish-white, dry, wrinkled colonies, firmly adherent to the medium. The colonies soon become confluent and form a broad, yellowish, wrinkled band, covered with rough projections.



FIG. 311.—*Discomyces bovis*. Culture on glycerin-agar (1 week).

Gelatin.—*Discomyces bovis* grows feebly on gelatin. Liquefaction takes place slowly and to a very slight extent. On plates, after incubating for about 6 days, small, greyish, punctiform colonies appear with yellow centres and irregular outline.

Potato.—After about a week or rather less, small colourless colonies appear; a few of these soon become greyish and prominent then the growth thickens and forms a yellowish, wrinkled, mammillated layer sometimes edged with black. The potato turns brown in the neighbourhood of the growth.

Milk.—Milk is not coagulated.

Cultures on seeds.—On fresh grains of corn or dry seeds softened in water *Discomyces bovis* grows as a yellowish, powdery layer and penetrates into the interior of the seed.

3. Biological properties.

Vitality.—*Discomyces bovis* is fairly resistant to heat and other destructive agents. Cultures are killed by exposure to a temperature of 70°–75° C. for 10 minutes (Wolff). Cultures on dried-up agar or gelatin live for more than a year. Poncet found the parasite alive in culture after being neglected for four years. Ordinary antiseptics appear to have little effect on the organism: but on the other hand, 1 drop of a 1 per cent. solution of methylene blue added to 10 c.c. of a broth culture sterilizes the latter.

Virulence.—The virulence of *Discomyces bovis* is attenuated by passage through the tissues of man and some of the lower animals. Its vegetative and pathogenic properties can be restored by growing it on vegetable tissues (Liebmann). A plant which grew from a seed inoculated with *Discomyces bovis*, was found to be infected, the parasite taking the form of very short filaments, and these were pathogenic on inoculation into animals (Liebmann).

Toxins.—Filtered glycerin-broth cultures of *Discomyces bovis* contain a toxin (*Streptothricine*, Delearde) which, like tuberculin, has very little effect on healthy animals, but in infected animals gives rise to a febrile reaction.

Association with other micro-organisms.—In the tissues, *Discomyces bovis* is frequently found in association with other organisms, most frequently with the more common organisms of suppuration, and occasionally in pulmonary lesions with the tubercle bacillus. Sputum in which the *Discomyces* has been found should always be examined for the tubercle bacillus.

The parasites of actinomycosis.

Recent investigations would tend to show that the clinical condition of actinomycosis is not a specific disease but may be due either to *Discomyces bovis* or to one of several other parasites which though differing from are all more or less related to it. Some cases of actinomycosis, for instance, have been shown to be due to *Discomyces asteroides* (*vide infra*) which has been found by several observers in human lesions. [*Discomyces liquefaciens* and *Discomyces garteni* (*vide infra*) have also been isolated from cases of the disease.]

Ferre and Fajuel, Scheele and Petruschky, have described cases of actinomycosis

caused by a *Discomyces* which gave white cultures and did not liquefy gelatin (*Discomyces alba*). In a case recorded by Sabrazès and Rivière the parasite was yellow on cultivation and did not liquefy gelatin (*Discomyces flava*). [*D. alba* and *D. flava* are probably the same species as *D. asteroides*.]

Levy isolated an orange-coloured *Discomyces* from a case of human actinomycosis. The parasite liquefied gelatin but did not appear to be pathogenic to the lower animals. This is possibly the polychrome *Discomyces* of Vallée (*vide infra*).

Lignières and Spitz have described an actinomycotic condition (*actino-bacillosis*) due to a *Discomyces* which is [said to be] readily distinguishable from the classical *Discomyces bovis*; it grows in artificial culture as a short bacillus and only rarely exhibits a filamentous appearance (on potato). This parasite, *Discomyces spitzii*, is pathogenic for cattle, sheep, rabbits and guinea-pigs. According to J. H. Wright, however, it is identical with *Discomyces bovis*. [Brumpt describes the organism as a bacillus (*Actinobacillus lignièresii* Brumpt). "The actinobacillus of Lignières and the tubercle bacillus (*Schlerothrix kochi* of Metchnikoff) are aberrant micro-organisms which many observers consider as fungi related to the *Discomyces*" (Brumpt).]

II. DISCOMYCES ISRAËLI.

[*Syn.*—*Streptothrix israëli* Kruse.—*Streptothrix spitzii* Lignières.—*Discomyces bovis* Brumpt.]

[*Discomyces israëli* closely resembles in its appearance in tissues and cultures *Discomyces bovis*, and by some observers the two parasites are regarded as the same species. The main difference between them would seem to be that cultures of *Discomyces bovis* are not inoculable into animals while *Discomyces israëli* readily gives rise to typical lesions of actinomycosis on inoculation into animals. *Discomyces israëli* moreover grows better under anaërobic conditions than when cultivated in presence of a free supply of air.]

[*Discomyces israëli* has been found in cattle in the Argentine by Lignières and Spitz, in both man and cattle by J. H. Wright in the United States, and in France it would appear that *Discomyces israëli* is a more common cause of actinomycosis in man than *Discomyces bovis*.]

III. DISCOMYCES THIBIERGI (Ravaut and Pinoy).

[This parasite was found by Ravaut and Pinoy in a patient suffering from disseminated nodules beneath the skin and in the muscles.]

[In the pus the parasite sometimes had the form of isolated bacilli, at other times it formed very small white grains quite different from the yellow grains seen with other parasites of actinomycosis. In the tissues it forms clubs.]

[*Discomyces thibiergi* grows easily both under aërobic and under anaërobic conditions. It appears to be devoid of pathogenic properties in the rabbit, guinea-pig, white rat and monkey (*Macacus*).]

IV. DISCOMYCES LIQUEFACIENS.

[*Discomyces liquefaciens* was isolated from a clinical case of actinomycosis. It does not form clubs in the tissues, is an obligatory aërobe, grows well on various media and is not pathogenic to laboratory animals (Brumpt).]

V. DISCOMYCES GARTENI.

[*Discomyces garteni*, isolated from a clinical case of actinomycosis, is an aërobic organism, and is pathogenic to certain animals. It forms no clubs (Brumpt).]

VI. DISCOMYCES ASTEROÏDES (Eppinger).

Syn.—*Oospora asteroïdes* (Sauvageau and Radais), *Nocardia asteroïdes* (Trevisan), *Streptothrix asteroïdes* (Gedoelst).

This organism was originally found by Eppinger in pure culture in the pus of a cerebral abscess in a person who had died of cerebro-spinal meningitis. The same observer has since found the parasite several times in conditions clinically resembling tuberculosis. Almquist also discovered what was apparently the same parasite in pus from a case of meningitis: Schabad, and MacCallum, have published similar observations.

Experimental inoculation.—*Discomyces asteroïdes* is pathogenic for rabbits and guinea-pigs. After inoculation the animals die of a pseudo-tuberculous condition and the parasite is found in large numbers in the tubercles.

Microscopical appearance.—*Discomyces asteroïdes* occurs in pus as branched filaments about 2μ broad. It forms no clubs. In cultures rounded or coccid forms (spores) are found as well as small bacillary filaments and branched forms. In old cultures the mycelial protoplasm is not homogeneous but shows vacuoles, separated by cubical and rounded granulations. In young cultures the filaments are frequently star-shaped—hence the name *asteroïdes*.

Discomyces asteroïdes stains with basic dyes and retains the violet in Gram's method: it stains with carbol-fuchsin but is more readily decolourized than the tubercle bacillus.

Cultures.—Agar containing 2 per cent. glucose is the most useful medium on which to grow the parasite. The colonies are warty in appearance, white at first but eventually becoming red-ochre in colour, while the surface becomes wrinkled and folded. The growth on gelatin is poor: the medium is not liquefied.

VII. DISCOMYCES FÖRSTERI (Gedoelst).

Syn.—*Oospora försteri* (Sauvageau and Radais), *Nocardia försteri* (Trevisan), *Streptothrix försteri* (Cohn).

Discomyces försteri is found in the lachrymal ducts, where it forms small whitish masses consisting of fine, slightly branched filaments, more or less twisted and mixed with coccid forms. Attempts to grow the organism have failed.

VIII. DISCOMYCES ROSENBACHI (Kruse).

Syn.—*Streptothrix rosenbachi*.

This fungus was isolated by Rosenbach from a sort of sub-acute erysipelas of the finger, which he described as *erysipeloid*. Rosenbach infected himself with the parasite and reproduced the symptoms of the condition.

Discomyces rosenbachi occurs as very fine twisted and slightly branched filaments; it grows readily on gelatin at 20° C., forming small grey-brown colonies consisting of bundles of filaments arranged around a more dense centre.

IX. DISCOMYCES MADURÆ.

Syn.—*Oospora maduræ*.—*Nocardia maduræ*.—*Streptothrix maduræ* Vincent.

If one of the small nodes characteristic of the disease known as Mycetoma or "Madura foot" be incised and squeezed a sanious pus exudes which contains small, yellowish-white grains, resembling the grains of actinomycosis.

In size the grains vary from a millet seed to a pin's head and consist of innumerable, closely interwoven hyphæ.

1. Microscopical appearance.—Under the microscope the grains will be found to be composed of very slender closely interwoven filaments straight or wavy and measuring 1μ – 1.5μ across. In the thinner parts of the film the filaments appear to be branched and at the periphery of the tangled mycelial masses there is a tendency to a radiating arrangement. Small irregular swellings measuring about 2μ are often seen at the extremity or in the length of the filaments, but clubs are never seen. All these details can be made out by staining with methylene blue or dilute carbol-fuchsin and examining under a magnification of 400 or 500 diameters.

In cultures the same arrangement is seen but the filaments are more slender and their breadth does not exceed 1μ . In cultures two weeks old the ends of the filaments are often broken up into regular, ovoid segments which are larger than the filaments themselves, and constitute the fertile hyphæ. The spores are refractile, oval in shape, and have sharply defined outlines. They measure 1.5μ – 2μ broad and are variously arranged in pairs, groups of three, chains or in large masses. When sown in a new tube of broth they elongate at one end, giving origin to a short rod with rounded ends.

Staining reactions.—*Discomyces maduræ* stains readily with the basic aniline dyes and retains the violet in Gram's method. Eosin and safranin stain the parasite feebly, iodine colours it yellow, hæmatoxylin, violet. The spores stain well with the basic dyes and by Gram's method.

Sections.—Excise some small pieces of skin containing either the young, hard, painful nodules or nodules which are softening. Examination of the material is rendered somewhat difficult on account of the ease with which the grains drop out of the tissues. Vincent recommends the following technique: Harden the pieces of skin successively in 60 per cent., 80 per cent., 90 per cent. and absolute alcohol. Embed in paraffin. Fix the sections on slides and stain with Orth's alcohol carmine and Gram's stain.

Under the microscope the whole of the diseased area is seen to form a large tubercle in the centre of which is a mycelial mass having the characteristics described above.

2. Cultural characteristics.—*Discomyces maduræ* grows at all temperatures between 20° and 40° C. but best at 37° C. It is a strict aërobie. Growth is always very small in amount on ordinary media: vegetable infusions are the most useful for growing cultures of the organism.

To isolate the parasite in pure culture sterilize the surface of the skin, incise one of the nodes with a sterile bistoury, introduce a fine pipette through the incision, and aspirate the contents of the tumour. Sow the material on one or other of the following media.

Culture media. Vegetable infusions.—An infusion (15 grams to the litre) of straw or hay (the aromatic plants must be removed) forms an excellent medium, as does an infusion of potato (20 grams to the litre). Cultures are best sown in Erlenmeyer flasks, on account of the free supply of air.

After incubating for 4 days at 37° C. small greyish flocculi appear, some of

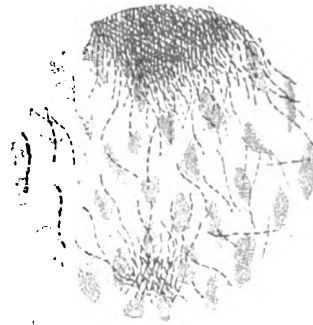

FIG. 312.—*Discomyces maduræ*.
(After Vincent.)

which adhere to the sides of the flask while others fall to the bottom. After 3 weeks' growth these flakes have attained the size of a green pea : some turn brown in the centre ; others, on the sides of the flask or on the surface of the medium, become pink or red in colour after a month or two. The liquid never becomes cloudy, but the surface is often covered with a white efflorescence formed by the spores.

Meat broth.—The growth on this medium is very scanty. After incubating for a fortnight, small, rounded, greyish granules are formed, the liquid remaining clear. After sub-culturing several times in broth the growth becomes more abundant.

Gelatin.—In ordinary gelatin a very scanty white growth forms along the line of the stab and on the surface of the medium. Growth is more abundant in the following medium :

| | | | | | |
|--|---|---|---|---|----------|
| Potato, or hay, infusion (<i>vide ante</i>), | - | - | - | - | 100 c.c. |
| Gelatin, | - | - | - | - | 9 grams. |
| Glycerin, | - | - | - | - | 4 " |
| Glucose, | - | - | - | - | 4 " |

Neutralize. Sterilize.

Disomyces madura does not liquefy gelatin.

Glucose-glycerin-agar.—Ordinary agar is not at all a suitable medium for the cultivation of the parasite, but on glucose-glycerin-agar it grows freely. The culture on the latter medium consists of circular, smooth, raised colonies yellowish-white at first, becoming pink and even bright red later, though the colour eventually disappears. When the colonies do not coalesce they become very large and umbilicated, the central depression being white while the raised margins are reddish.

Potato.—After incubating for 5 days at 37° C. small whitish projections are seen, and these later assume a mulberry-like appearance. Around the growth the potato is depressed, but it does not change colour. When incubated for a month the colonies are pale pink in colour and in places the colour deepens and ultimately becomes bright red, orange or deep red. The more acid the potato the more intense the colour. Some of the colonies appear powdered with a fine whitish dust which consists of spores. Some potatoes are unsuitable for the growth of the organism.

Milk.—Growth takes place without coagulation of the medium.

Serum. Egg.—No growth takes place on these media.

3. Biological properties.—All attempts to inoculate animals have failed (Vincent and Nocard).

Disomyces madura is very resistant to drying ; cultures dried on sterile blotting paper for 9 months have subsequently given a growth when sown on culture media. A culture on potato 21 months old was still alive. Non-spore-bearing cultures are killed in from 3–5 minutes at a temperature of 60° C. Spores resist a temperature of 75° C. for 5 minutes but are killed in 3 minutes at a temperature of 85° C.

Associated micro-organisms.—In suppurating nodules opening externally Vincent found besides the *Disomyces*, *Staphylococcus aureus* and *S. albus*.

X. DISCOMYCES FREERI.

Syn.—*Streptothrix freeri*.

[This parasite was found by Musgrave and Clegg in a mycetoma of the foot in a native woman in Manilla.

[It grows freely on artificial media but only under aërobic conditions.

[By inoculating pus from the lesion and pure cultures of the organism Musgrave and Clegg reproduced a typical mycetoma in the feet of three monkeys (*Macacus philippinensis*). Intra-peritoneal inoculation proved fatal to monkeys, dogs and guinea-pigs. Sub-cutaneous inoculation was not followed by generalization of the disease.]

XI. DISCOMYCES BRASILIENSIS.

[*Discomyces brasiliensis* was isolated by Lindenberg from a case of mycetoma. It is strictly aerobic; it grows poorly at 37° C. but at ordinary room temperature grows well on all ordinary media. The organism does not appear to be pathogenic to rabbits, guinea-pigs and pigeons.]

The parasites of Mycetoma.

Syn.—*Madura foot*.—[*Actinomycosis*.—*Pseudo-actinomycosis*.]

The endemic disease of warm climates for a long time inappropriately described as *Madura foot*, and now at Laveran's suggestion known as *Mycetoma*, comprises several clinical varieties: the *white* or ochroid, the *black* or melanoid and the *red*. As the result of the investigations of Vincent, mycetoma was considered to be due solely to an infection with a single species of *Discomyces* (*D. maduræ* Vincent) but more recent researches have shown that though infection with *D. maduræ* may be the commonest cause of mycetoma, many cases are caused by other and very different species of fungi.

The **white variety** is due to the following parasites stated in the order of the frequency with which they occur, viz.:—*Discomyces maduræ*, [*Indiella somaliensis*, which is perhaps even more common in India than *D. maduræ* (Manson)], *Sterigmatocystis nidulans*, *Indiella mansonii*, *Indiella reynieri*, and occasionally *Discomyces bovis* (actinomycotic mycetoma), [*Discomyces freeri* and *Discomyces brasiliensis*].

The **melanoid variety** is caused by two parasites, *Aspergillus bouffardi* and *Madurella mycetomi*, which though provisionally regarded as distinct are probably identical species.

In a case of mycetoma of the **red variety**, Laveran and Pelletieri found zoogloea masses of pink micrococci (*M. pelletieri*).

Aspergillary mycetomata. *White varieties*.—Nicolle has recorded a case of mycetoma in Tunis due to *Sterigmatocystis* (*Aspergillus*) *nidulans* (p. 699). The grains, yellowish-white in colour, some as large as a pea, were more or less spherical and had a smooth surface. Microscopically they consisted of large septate mycelial filaments.

[*Indiella somaliensis*¹ is described by Brumpt as being the infecting agent in two cases of white mycetoma observed by Bouffard in Somaliland. This form of the disease appears to be very wide-spread in India.]

*Indiella mansonii*¹ described by Brumpt in a case of mycetoma in India and *Indiella reynieri* found by Reynier in a case in Paris appear to be closely related to *Sterigmatocystis nidulans*.

Melanoid variety.—Cases of melanoid mycetoma characterized by the presence of lesions with small, brittle, irregular-shaped black grains have been reported from Africa (French Soudan and Senegal), Italy [and India], and were due to a species of *Aspergillus*,¹ *Madurella mycetomi* (Laveran).

[¹The provisional genera *Indiella* and *Madurella* are classified by Brumpt with the *Hypomycetes*. These parasites have certain affinities with the genera *Aspergillus* and *Sterigmatocystis* (Brumpt).]

The parasite—*Aspergillus bouffardi*—found by Bouffard in cases of mycetoma in Djibouti and India is apparently identical with *Madurella mycetomi*. These parasites have not yet been grown in artificial culture.

[Classification of the parasites of mycetoma.]

- | | | |
|--|----------------------|--|
| [1. Species of Ascomycetes, - - - | - - - | <i>Sterigmatocystis nidulans</i> Nicolle's white mycetoma. |
| By some observers classified with Ascomycetes by others with Hypomycetes, - - - | } probably identical | { <i>Aspergillus bouffardi</i> Bouffard's black mycetoma. <i>Madurella mycetomi</i> Classical black mycetoma. <i>Indiella mansonii</i> Brumpt's white mycetoma. <i>Indiella reynieri</i> Reynier's white mycetoma. <i>Indiella somaliensis</i> Bouffard's white mycetoma. |
| | | { <i>Discomyces maduræ</i> Vincent's white mycetoma. <i>Discomyces bovis</i> Actinomycotic mycetoma. <i>Discomyces freeri</i> Musgrave and Clegg's white mycetoma. <i>Discomyces brasiliensis</i> Lindenberg's white mycetoma. |
| [2. Species of Hypomycetes, - - - | - - - | |
| [3. <i>Micrococcus pelletieri</i> , - - - | - - - | The red mycetoma.] |

XII. DISCOMYCES MINUTISSIMUS.

Syn.—*Microsporium minutissimum*.

The parasite of *erythrasma* was described by Burchardt under the name *Microsporium minutissimum*. This parasite should be placed among the Oosporidæ as a species of the genus *Discomyces*.

Detection.—The same methods are available for the detection of *D. minutissimus* as will be described for *Malassezia furfur*. Sabouraud recommends the following technique. Treat the scales with ether, then with glacial acetic acid, wash in absolute alcohol, stain with Unna's blue, carbol-thionin or Gram's stain, pass through alcohol and xylol and mount in balsam.

Microscopical appearance.—The parasite, which is present in considerable numbers in the corneal layer of the epidermis, consists of a long, delicate, wavy, tangled and branched mycelium, divided into segments which are arranged end to end and often separated from one another in such a way as to resemble bacilli: the filaments occasionally end in a cluster of very small rounded spores.

Cultures.—According to De Michele, *D. minutissimus* grows easily on ordinary media, producing on gelatin a brownish, and on potato a wine-red layer of growth. Man can be inoculated with cultures if the skin be first scratched with a lancet. Ducrey and Reale dispute De Michele's conclusions: they consider that the cultures used by that observer were not cultures of the parasite of *erythrasma* at all. In their opinion *D. minutissimus* grows with

considerable difficulty on ordinary media between 25° and 30° C., and gives a white growth on agar and gelatin, and a reddish-brown growth on potato.

XIII. DISCOMYCES FARCINICUS (Nocard).

Syn.—*Nocardia farcinica*.—*Oospora farcinica*.—[*Streptothrix farcinicus*.]

This species of *Discomyces*, described by Nocard, is not pathogenic to man.

Bovine farcy only affects cattle and must be carefully distinguished from farcy due to the glanders bacillus which occurs in man and the horse. It is characterized by adenitis and superficial lymphangitis followed later by lesions of the lungs and viscera. *Discomyces farcinicus* is probably to be found in stable-litter and soil, and it appears likely that animals become infected through some solution of continuity of the integuments. In Guadeloupe the disease is thought to be transmitted by a tick of the family Ixodidae (*Hyalomma aegyptium*).

1. Experimental inoculation.

The parasite of bovine farcy is inoculable into cattle, sheep and guinea-pigs. Guinea-pigs are the most suitable animals for experimental purposes. Rabbits, horses and dogs are immune.

In guinea-pigs sub-cutaneous inoculation leads to the formation of an enormous abscess complicated by lymphangitis. The abscess ultimately discharges externally and the animal recovers.

Intra-peritoneal inoculation leads in 2 or 3 weeks to a condition resembling tuberculous peritonitis: the omentum and the surfaces of the abdominal viscera are covered with tubercle-like nodules.

Intra-venous inoculation is rapidly fatal and produces a true generalized miliary tuberculous-like condition. All the viscera are infiltrated with miliary granulations.

2. Morphology and methods of detection.

(α) **Microscopical appearance.**—The fungus of bovine farcy occurs as delicate filaments twisted into clusters from the periphery of which numerous prolongations take origin, giving an appearance very like that of the seeds of burrs. The filaments are not much branched. "Clubs" are never seen.

In cultures numerous very small oval spores are found, which do not stain by ordinary methods.

Staining reactions.—The organism stains with the basic aniline dyes and is gram-positive.

(β) **Methods of detection.**—Films should be prepared with the pus and, after staining by Gram's method and eosin, examined for the parasite.

For sections, harden the pseudo-tuberculous lesions in alcohol, embed in paraffin and stain by Gram's method, using eosin or Orth's picrocarmin as a ground stain. The clusters of filaments will be found in the centres of the tubercles.

(γ) **Cultural characteristics.**—*Discomyces farcinicus* is a strictly aerobic organism and grows on ordinary media when incubated at between 30° and 40° C. Pure cultures can be easily obtained by removing with a Pasteur pipette some of the material from the centre of an abscess which has not opened externally.

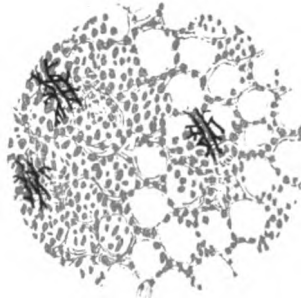

FIG. 313.—*Discomyces farcinicus*. Section of sheep's lung. Gram's stain. (Oc. II, obj. 9, Reich.)

Culture media. Broth.—Whitish irregular flakes appear, some of which float on the surface and form a greyish dusty pellicle while others fall to the bottom. The medium remains clear.

Glycerin-broth.—A similar but more luxuriant growth.

Agar.—Small, rounded, raised, opaque, yellowish-white colonies develop, which coalesce to form a mammillated, folded, dull, dusty-looking culture.

Serum.—The growth has the same characteristics as on agar but is less abundant.

Potato.—An abundant growth develops consisting of considerably raised, dry, scaly, yellowish plaques with sharp cut edges.

Milk.—The growth assumes the form of small greyish granules. The medium is not coagulated.

XIV. DISCOMYCES CAPRÆ (Gedoelst).

Syn.—*Streptothrix capræ* Silberschmidt.

This parasite was found in the lung of a goat affected with pseudo-tuberculosis.

1. Experimental inoculation.

Cultures of *Discomyces capræ* are virulent for rabbits and guinea-pigs: white mice are susceptible but to a lesser degree.

Sub-cutaneous inoculation into rabbits and guinea-pigs leads to the formation of an abscess; inoculated intra-venously the parasite produces tubercles in the internal organs. "On histological examination these tubercles show a structure similar to that of true tubercles due to the tubercle bacillus. Giant cells are found in the lungs. The tubercles rapidly caseate" (Silberschmidt).

2. Morphology.

(α) **Microscopical appearance.**—The mycelium consists of very fine, more or less branched filaments of varying length. In the tissues the longer forms predominate: in agar cultures, on the other hand, and in colonies growing on the surface of broth, short rod-shaped forms are the most noticeable feature.

Discomyces capræ is non-motile: in cultures it forms elongated spores which are readily decolourized and are only slightly resistant to heat.

Staining reactions.—*Discomyces capræ* stains with the basic dyes containing a mordant: it is gram-positive. In the tissues the organism is more difficult to stain than in cultures: use Gram's stain with eosin as a counter-stain.

(β) **Cultural characteristics.**—*Discomyces capræ* is almost strictly aërobic. It grows at ordinary temperatures (but best at 33°–37° C.) on the ordinary culture media, but particularly well on 2 per cent. glucose broth and on potato.

Culture media. Gelatin.—Gelatin is not liquefied. In plate culture, the colonies develop slowly and resemble small colonies of moulds. In stab culture, discrete flocculent colonies develop in the depth of the medium, while on the surface the growth takes the form of a dry brownish layer.

Glycerin-agar.—A dry brownish layer appears, subsequently sprinkled with white. The culture grows into the agar in the form of fine radiating prolongations. Occasionally the colonies have a crater-like depression in the centre.

Broth.—Sugar broth is better than ordinary broth. Growth is visible after about 48 hours in the warm incubator (37° C.); the medium is clear; small

colonies like thin concave discs, dry and whitish, have grown on the surface. Later they become confluent, cover the whole of the surface of the liquid and climb up the sides of the vessel. Some of the colonies fall to the bottom of the tube and form a rather scanty deposit.

Potato.—On potato, a thin whitish growth appears and later becomes prominent, brownish-pink in colour and sprinkled with white.

Milk.—The surface of the medium is covered with a pinkish-white growth. The milk is not coagulated.

XV. DISCOMYCES HOFMANNI.

Syn.—*Oospora hofmanni*.—*Nocardia hofmanni* Trevisan.—*Micromyces hofmanni* Max Grüber.

Max Grüber isolated from air a streptothrix, *Discomyces hofmanni*, which is very like *Discomyces bovis*, but when inoculated into rabbits produces a local abscess which resolves spontaneously. Growth in artificial culture media begins at 22° C. : glucose-agar is the best medium : no growth takes place on potato and ordinary gelatin.

XVI. THE POLYCHROME DISCOMYCES OF VALLÉE.

This streptothrix, found by Vallée in the blood of an horse which had died of an acute pasteurellosis, does not infect either laboratory animals or the larger animals, but in broth cultures forms a toxin which is fatal to rabbits and guinea-pigs.

It is a strict aërobie and grows on all the ordinary culture media. Cultures on peptone media are salmon red : on glycerin media, yellow : on potato the organism forms a pellicle which is at first pinkish-grey, and, as it becomes older, red.

SECTION II.—THE GENUS MALASSEZIA.

1. *Malassezia furfur*.

Syn.—*Microsporum furfur*.

Pityriasis versicolor (*Tinea versicolor*) is due to a fungus, *Malassezia furfur*, discovered by Eichstedt.

Methods of examination.—Detach a few of the epithelial scales from a patch of pityriasis by lightly scraping the latter with the edge of a slide, soak them in a few drops of a warm 40 per cent. solution of potash on a slide and examine them in the solution (p. 690). The scales may also be treated with acetic acid and mounted in glycerin tinted with eosin.

Masses of the fungus will be seen lying in the interstices between the epithelial cells. The parasite consists of mycelial filaments and rounded corpuscles : the corpuscles are spherical, measuring 3–5 μ in diameter, and are enclosed in a cuticle of cellulose arranged spirally : the mycelial filaments are short, measuring 3–4 μ in diameter, septate, somewhat wavy, slightly branched, sometimes placed end to end and often bent on themselves in the form of a V.

Very little is known of the development of *Malassezia furfur*.

Cultures.—*Malassezia furfur* is a difficult organism to grow though cultures have been obtained by Spielschka and by Matzenauer. Media containing glycerin are the best for the purpose (Kotliar). On glycerin-agar at 37° C. small wrinkled pale yellow colonies are formed, and these may attain the

size of a pin's head. On gelatin, growth is very slow. In broth, small white tufted almost translucent flocculi appear.

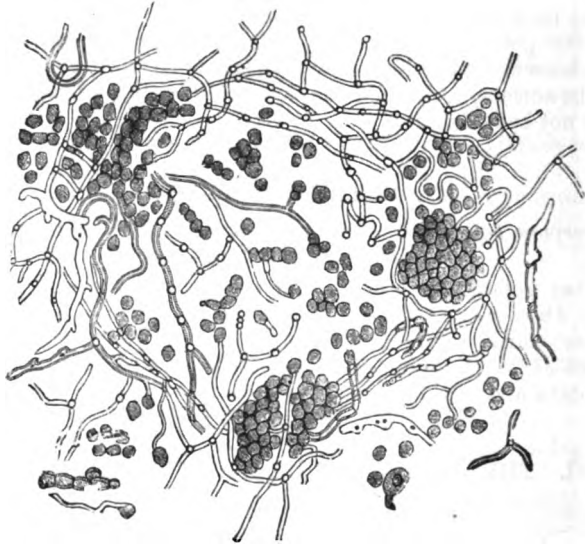

FIG. 314.—*Malassezia furfur*.

Experimental inoculation.—Positive results have been obtained by inoculating cultures on the human arm (Spielschka, Matzenauer).

In rabbits, by rubbing a culture of the fungus into a shaved area of the skin and protecting the inoculated part with a dressing, characteristic patches are formed in about a week.

Species of malassezia found in the tropics.

[2. *Malassezia tropica*.—*M. tropica* is the infecting agent in *Pityriasis versicolor flava* (*Tinea rosea*) a common disease in Ceylon. The fungus has a thick, irregular, constricted mycelium.

[3. *Malassezia macfadyeni*.—This fungus is the cause of another mycotic pityriasis in Ceylon, *Pityriasis versicolor alba*. The fungus has a short, slender, straight mycelium.

[4. *Malassezia mansoni*. (Syn.: *Microsporon mansoni*).—This species is the cause of *Pityriasis versicolor nigra*, a variety described many years ago by Manson as occurring in South China. The parasite contains much dark pigment in the mycelial tubes, and in culture in maltose-agar produces black hemispherical colonies. It is very common in Ceylon.]

SECTION III.—THE GENUS TRICHOSPORUM.

Parasites of the genus *Trichosporum* are fungi which grow on the hair of the head, beard and moustache and form nodosities of firm but variable consistence. The parasite was first found in Colombia, South America, on the hair of a woman affected with *Piedra*.¹ Cases of Trichosporosis have since been

[¹ *Piedra*, a stone: from the consistence of the nodosities, which though very firm are not so hard as the name would indicate (Manson).]

described in Europe in which the hair of the head and beard was attacked.

In trichosporosis the interior of the hair is never affected, but on the surface the parasite forms irregular nodosities which more or less completely surround it.

These little nodosities consist of an amorphous substance containing short or elongated cells which from mutual pressure are polyhedral: after dissociation in potash the greater number of the cells are seen to be placed end to end in branched chains. In cultures on solid media these cells elongate and form true filaments.

Fungi of the genus *Trichosporum* grow easily on agar, gelatin, broth, potato, Raulin's and other media.

Several species have been described: *Trichosporum giganteum*, the cause of Piedra in Colombia, which forms very firm nodosities (Behrend); *Trichosporum ovoïdes* (Behrend), *Trichosporum ovale* (Unna), *Trichosporum beigeli* (Beigel, Vuillemin) found on the hair of the beard and moustache in Europe. [*Trichosporum krusi* and *Trichosporum fori* are species found by Castellani in Ceylon.]

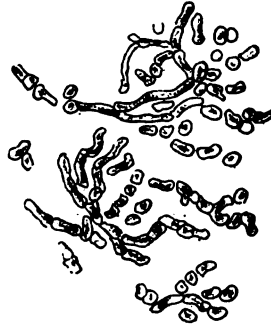

FIG. 315.—Culture of *Trichosporum*.
(After Jubel-Rényoy.)

SECTION IV.—THE GENUS COCCIDIODES.

These parasites are still little known. They were first found in man by Wernicke in Buenos-Ayres in a case of dermatitis (cancerous dermatitis, Guiart), afterwards by Rixford and Gilchrist in the United States, by Posadas in Argentina and has also been seen in San Francisco.

The disease beginning in the skin more or less rapidly infects the lymphatics, becomes generalized, and after a variable length of time terminates fatally; it can be reproduced in mammals and birds by sub-cutaneous inoculation, monkeys being very susceptible to infection (Posadas). In the neighbourhood of the infected spots, the skin becomes covered with papules; these unite and form plaques the centres of which ulcerate and discharge a purulent fluid containing numerous cysts; in the glands and internal organs, the lesions are similar to those in miliary tuberculosis.

In the lesions of the skin the parasite is not found within the epithelial cells but in tubercles similar to the tubercles of actinomycosis (giant cell formation containing the Coccidioides and surrounded by epithelioid cells). The parasite is present in large numbers in the pus.

Blanchard considers that the various parasitic forms which have been described are all identical (*Coccidioides immitis*), though other observers regard them as constituting three different species. Blanchard originally classified the parasite with the Coccidia among the Sporozoa. Since then, however, Büschke, Ophüls, Cohn, have shown that it will grow on agar, giving origin to mycelial filaments and budding forms: it therefore becomes necessary to transfer the parasite to the fungi, and it is possibly closely allied to the genus *Oidium*.

C. immitis consists of spherical corpuscles, 20–80 μ in diameter, enclosed within a thick cuticle. It grows easily on agar and the cultures on inoculation will infect susceptible animals. Both in the tissues and in cultures some of the spherical bodies appear to contain spores which are set free by dehiscence of the enveloping membrane.

SECTION V.—THE GENUS SPOROTRICHUM.

A disease, characterized chiefly by the presence of "chronic sub-cutaneous abscesses" or "multiple disseminated gummata" which in the course of 5 or 6 weeks soften and break down, was first described as occurring in man by Schenk. Since then cases have been recorded by Hektoen and Perkins, de Beurmann, and by Ramond and Matruchot.

This disease has been shown to be due to a fungus to which Smith gave the name *Sporotrichum*. Two species were originally described—*S. schenki* (Hektoen and Perkins), and *S. beurmanni* (Ramond and Matruchot)—but they appear to be identical and should be regarded as one, viz. : *S. schenki*. Numerous cases of sporotrichosis have now been studied by, among others, Dor (*S. dori* ?), de Beurmann and Gougerot, Nattan-Larrier and Lœper, etc. The parasite may infect the buccal, pharyngeal and laryngeal mucous membranes, may produce "gummata" in the muscles and in the mammary gland, and also papular and vesicular dermatitis, osteitis, synovitis and adenitis.

1. Morphology and methods of detection.

To demonstrate the parasite it is best to collect some pus from a non-ulcerated "gumma" with a sterile syringe, using a needle of large calibre and adopting the necessary precautions to prevent contamination. A portion of the material should be examined microscopically after staining with Unna's blue, and some should be sown on Sabouraud's glucose-agar (*vide infra*).

(a) **Microscopical appearances.**—In pus, the *Sporotrichum* has the appearance of a yeast and consists of oval or fusiform bodies representing spores or conidia and measuring $3-6\mu \times 2-4\mu$.

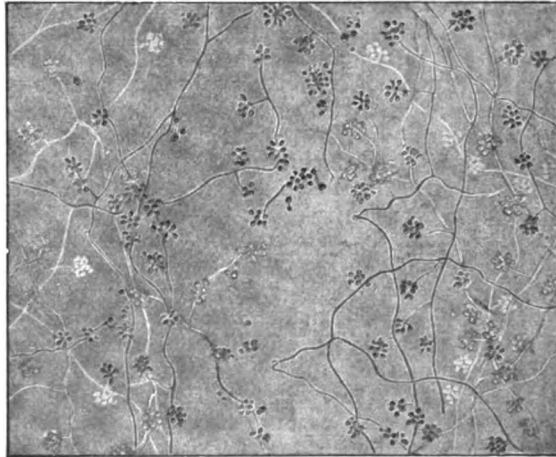

FIG. 316.—Culture of *Sporotrichum*. (After Monier-Vinard.)

To study the morphology of the parasite the slide cultivation method of de Beurmann and Gougerot is the best. Pour a little Sabouraud's agar (*vide infra*) into a large tube, and stand two or three pairs of slides separated by little pieces of cork vertically in the tube: only the lower ends of the slides should touch the agar. Sterilize in the autoclave and then by tilting the tube run the melted agar over the surfaces of the slides. Sow the thin film

of agar deposited on the slides by lightly touching it with a platinum needle charged with pus. Small colonies soon appear on the slides if kept at the ordinary temperature and they can be examined directly.

The colonies consist of a mycelium and spores.

The spreading mycelium is formed of long, delicate, colourless, septate and branched filaments measuring about 2μ across.

The spores or conidia are brown, oval or fusiform ($3-6\mu \times 2-4\mu$) and though occasionally arranged round the mycelial filaments, are more frequently collected in clusters of 3 to 30 on the end of the filaments.

In some sugar media no mycelium is seen, and the parasite then assumes the yeast-like appearance which it has in the tissues.

Staining reactions.—The *Sporotrichum* stains easily with the aniline dyes and particularly well with Unna's blue: hæmatoxylin is useful for staining the spores. The parasite stains irregularly with Gram's stain, portions only of the mycelium retaining the violet. The spores are, to some extent, acid-fast.

(β) **Cultures.**—The *Sporotrichum* grows only in presence of air: on ordinary media the growth is poor but on media containing sugar or glycerin it grows luxuriantly. Sabouraud's agar is the most suitable medium:

| | | | | | | | | | | |
|----------------|---|---|---|---|---|---|---|---|------|--------|
| Water, | - | - | - | - | - | - | - | - | 1000 | c.c. |
| Peptone, | - | - | - | - | - | - | - | - | 10 | grams. |
| Crude glucose, | - | - | - | - | - | - | - | - | 40 | " |
| Agar, | - | - | - | - | - | - | - | - | 18 | " |

The organism grows at any temperatures between 12° - 39° C., but best between 20° and 30° C.

Sabouraud's agar.—Sow 1 c.c. of pus on the surface of the medium and leave at the temperature of the laboratory. De Beurmann and Gougerot adopt this method of cultivation as a means of diagnosis.

In from 4-10 days a characteristic growth develops: at first a dull spot, about the sixth day it becomes whitish streaked with blue, dry and convex; later the colony folds on itself like the convolutions of the brain and is surrounded by a shiny areola; after about 12 days to 3 weeks the colour changes to brown and then to brownish-black, while the areola remains white and becomes covered with a white dust.

If at the same time as the surface of the medium is sown the dry wall of the tube be also sown the organism grows on the glass, and can be examined in that situation.

Glucose-broth.—Growth takes the form of white pellicles which are formed one after another each in turn sinking to the bottom; occasionally in old cultures the pellicle is brown. The broth remains clear.

Glycerin-carrot. Glycerin-beetroot.—White colonies appear in about 3 days; these rapidly coalesce to form a layer which is at first white and later brown or even black, the growth at the same time becoming folded and looking as though dusted with powder.

2. Experimental inoculation.

Rats and white mice are particularly susceptible. Sub-cutaneous inoculation is followed by the formation of an abscess at the site of inoculation, which subsequently softens and ulcerates; then a number of sub-cutaneous "gummata" appear, osteo-arthritis develops in several joints and occasionally abscesses form in the lungs, liver and spleen.

Intra-peritoneal inoculation leads to an acute miliary pseudo-tuberculosis or to lesions of sub-acute pseudo-tuberculosis. In male rats a double orchitis is a common complication (de Beurmann, Gougerot and Vaucher).

Monkeys are also susceptible. Rabbits, newly-born guinea pigs, dogs and

newly-born cats can also be infected (gummata, pulmonary tubercles, granular lesions).

3. Serum diagnosis.

The serum of persons suffering from sporotrichosis agglutinates the spores of the parasite (*sporo-agglutination* of Widal and Abrami).

For the purposes of the reaction take a portion of an one to three-months' old culture on Sabouraud's medium, break it up dry in a mortar, make an emulsion with the powder in a little normal saline solution and filter through paper. Mix the filtrate with the serum to be tested.

Under these conditions the serum from a case of sporotrichosis agglutinates the spores in 50–60 minutes when diluted 400 to 500 times. Normal serum has no agglutinating action. The serum of persons suffering from actinomycosis occasionally agglutinates the spores of *Sporotrichum* but only when much less highly diluted—1–60 at most (group-agglutination).

Complement fixation.—The serum of persons suffering from sporotrichosis contains specific immune bodies (*sensibilisatrices*) (Widal and Abrami, Joltrain and Weil, Brissaud). This can be shown by the ordinary methods of complement fixation (p. 233).

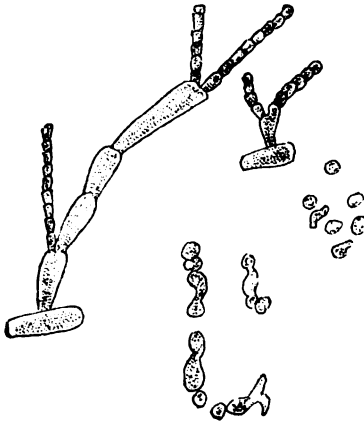

FIG. 317.—*Oidium lactis*.

SECTION VI.—THE GENUS OIDIUM.

The genus *Oidium* includes several parasitic species of phanerogamic vegetable organisms.

One saprophytic species, *Oidium lactis*, is very widely distributed and forms greyish mucous spots: the fungus consists of elongated cells placed end to end: the terminal cells of the chains carry rows of spores: numerous cells can be seen in the act of budding.

Under the name *Oidium subtile cutis* Babès has described a fungus which he found on certain ulcers in a woman. He was able to reproduce similar lesions in rabbits (p. 701, also p. 704).

SECTION VII.—[OF UNKNOWN CLASSIFICATION.]

The parasite of the disease Bursattee, or Leeches.

The disease of horses, mules and cattle in the United States and of horses in India, characterized by the formation of nodules and known in the United States as *Leeches* and in India as *Bursattee*, is caused by a fungus discovered by Steel and described by F. Smith.

In the nodosites irregularly branched and occasionally swollen filaments are found. Around the periphery of the latter small spherical bodies (spores?) are frequently seen, and in the meshes of the mycelial network rounded disc-like bodies are found the significance of which is quite unknown. The parasite has never been grown in artificial culture. Animals cannot be infected by inoculation.

To prepare microscopical preparations, dissociate the nodules by soaking in a 10 per cent. solution of caustic potash in the cold for 12–24 hours. Sections should be stained with methylene blue and eosin or with the Ehrlich-Biondi mixture.

CHAPTER XLIX.

PARASITES OF THE FAMILY MUCORACIDÆ.

Introduction.—General methods of examination, cultivation, etc.

Section I.—The genus *Mucor*, p. 676.

Section II.—The genus *Lichtheimia*, p. 677.

Section III.—The genus *Rhizomucor*, p. 678.

Section IV.—The genus *Rhizopus*, p. 678.

THE Mucoracidae, or moulds,¹ are phycomycetous fungi of very wide distribution.

The Mucoracidae are characterized by a non-septate mycelium carrying spore-bearing hyphæ. Under anaërobic conditions, however, the mycelium breaks up into very short septa resembling yeasts. Reproduction takes place either sexually or asexually; in the former case by means of *zygospores* and in the latter by means of *sporangia*.

For a long time the Mucoracidae were regarded as purely saprophytic organisms, but in recent years it has been recognized that they play a part in human and comparative pathology.

1. Microscopical examination of infected tissues.—Prepare films with the pus or other material and stain with methylene blue, thionin, or gentian-violet. It is often better to examine the material fresh.

For histological purposes, cut sections of the tissue and stain with hæmatoxylin, wash, counterstain with eosin, dehydrate and mount in balsam or dammar resin.

2. Cultures.—The Mucoracidae grow best on an acid medium. They can be easily cultivated on slices of fruit or potato and on pieces of sterile bread. A simple method is to cut a slice of bread into small pieces leaving the crust on one side, and place them in potato tubes with a little water at the bottom, then plug the tube with wool and sterilize at 115°–120° C.

Decoctions made of dried fruit, hay, yeast, or beer-wort, and Nægeli's, Raulin's or Sabouraud's media either as liquid or after solidification with gelatin, are all useful for growing the species of this family.

3. Isolation of the fungus.—According to Gedoelst the most satisfactory method of getting a pure culture from a single spore is to dip a sporangium into a watch-glass containing a little sterile water. The sporangium bursts immediately and the spores are set free in the water; leave them in the water to swell for a few hours. Then with a platinum loop take up a drop of the water, spread it on a sterile slide

¹ The term "mould" as generally used is applied somewhat loosely, and includes beside the Mucoracidae a number of fungi belonging to the order of the Ascomycetes. These will be considered later.

and examine it to see that it does not contain more than one spore; if there should be more than one blot up some of the water with sterile filter paper until the drop which remains contains only a single spore. Now place a drop of nutrient medium on the preparation and by arranging a moist chamber the growth of the fungus can be studied under the microscope.

4. Microscopical examination of cultures.—In making microscopical preparations of cultures certain precautions must be taken. The simplest method is to cut off a small piece of the mould with a pair of fine scissors and transfer it to a drop of alcohol on a slide—water must not be used because not only does it fail to wet the fungus properly but it also causes the sporangium to burst—cover with a cover-glass and run in a drop of glycerin. This is easily done by placing a drop of glycerin at one edge of the cover-glass and drawing it through with a fragment of blotting paper held at the opposite edge.—Another method is to place the mould in a drop of 0.5 per cent. osmic acid on a slide, leave for a few minutes, wash in alcohol then in distilled water and finally mount in glycerin. The preparation may, if necessary, be stained in an aqueous solution of safranin after soaking in osmic acid.

The following is the method recommended by Salomonsen when it is desired to examine a whole colony. Transfer a young colony to a slide, cover gently with a cover-glass, allow it to dry for a few minutes and then place a large drop of osmic acid solution at one edge of the cover-glass. When, after a few minutes, the osmic acid has thoroughly penetrated the preparation, blot up the excess and run first a drop of water and then a drop of glycerin under the cover-glass.

5. Inoculation experiments.—Attention was first drawn to the pathogenic properties of some of the *Mucors* (the white moulds) by Lichtheim and by Lindt and the observations of these investigators have been confirmed by Lucet and Costantin.

The severity of the disease following inoculation of these fungi depends not so much upon the virulence of the parasite as upon the number of individuals inoculated; and herein they present a great contrast to the bacteria. This may be explained by the fact that though the spores germinate when introduced into the tissues, reproduction has never been known to occur in the body. Direct transmission of the parasite from animal to animal has never been observed; when infection occurs, it is the result of the inoculation of spores. It is not possible to produce an infection by direct inoculation of portions of the mycelium, and before infection of a healthy animal can be effected spores must have been formed outside the tissues of the living body.

A disease fatal in a few days follows the inoculation of the spores of *Lichtheimia corymbifera*, *Mucor pusillus*, etc. into the veins or peritoneal cavities of rabbits; and when the tissues are examined *post mortem* numerous mycelial threads will be found in the kidneys (which show lesions of nephritis), Peyer's patches and also in the lungs (Lichtheim, Barthelat). The inoculation of *Rhizomucor parasiticus* into the veins of rabbits, guinea-pigs or fowls also leads to a fatal disease (Lucet and Costantin).

SECTION I.—THE GENUS MUCOR.

Mucor mucedo.

Mucor mucedo is one of the moulds most commonly found in food-stuffs and other organic matter. It grows luxuriantly producing tall, whitish, woolly-looking tufts. The mycelium is branched and gives rise to tall spore-bearing hyphæ or *pedicels*, each of which is swollen at its distal end into a

columella, and around every columella a large bristly *sporangium* is formed (fig. 318 S.). The sporangium opens after the manner of an hinged soap box and sets free the rounded spores contained within it.

Two cases of human pulmonary mycosis have been attributed to this parasite by Fürbinger (but see *L. corymbifera*). And according to Hess, *M. mucedo* is the cause of a fatal disease in bees—*muscardine*. [It is also pathogenic for fish.] On rabbits and guinea-pigs the inoculation of *M. mucedo* has no effect (Barthelat).

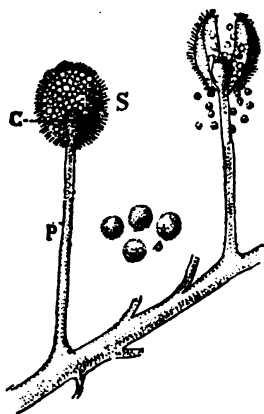

FIG. 318.—*Mucor mucedo*. P, pedicel; C, columella; S, sporangium.

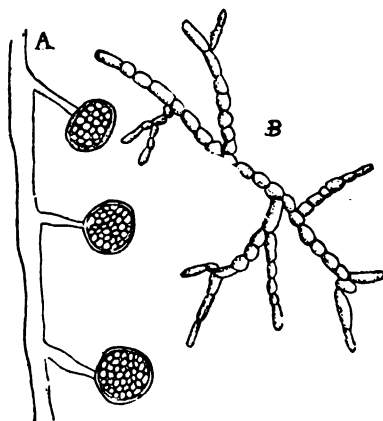

FIG. 319.—*Lichtheimia racemosa*. A, raceme-like sporangia. (After Fischer.) B, yeast-like mycelium.

[SECTION II.—THE GENUS LICHTHEIMIA.]

1. *Lichtheimia racemosa*.

Syn.—*Mucor racemosus*.

This again is a widely distributed species. The spore-bearing hyphæ are straight and irregularly branched, the branches being short, simple and ending in sporangia. *L. racemosa* is not pathogenic to guinea-pigs or rabbits. Several cases of pulmonary mycosis observed in birds were, however, believed by Bollinger to be due to this organism.

2. *Lichtheimia corymbifera*.

Syn.—*Mucor corymbifer*.

The pathogenic properties of this fungus are better known than those of the other moulds. Morphologically, it is differentiated from the preceding species by the fact that its flat hyphæ are indistinguishable by the naked eye from the thick white mycelium. The hyphæ carry several sporangia arranged in a corymb.

In the majority of the experimental inoculations with the Mucoracidæ this has been the species inoculated. It is pathogenic for rabbits (*vide ante*). It has been found in man in the ear (auricular mucor-mycosis) and in the pharynx (naso-pharyngeal mucor-mycosis) (Siebenham, Hückel and others). One case of generalized mucor-mycosis in man in which the symptoms were of a typhoid nature was attributed to this parasite (Paltauf); and it would seem that the two cases of human mycosis (pulmonary mucor-mycosis) described by Fürbinger and referred to above should be attributed to this

species rather than to *M. mucedo*. It has been recorded also in association with a Tricophyton parasite in the epidermal scales of the horse (Lucet and Costantin).

SECTION III.—THE GENUS RHIZOMUCOR.

Rhizomucor parasiticus.

This species was found by Lucet and Costantin in the sputum of a woman suffering from a condition resembling tuberculosis.

In cultures, it gives rise to a mycelium grey at first and later fawn-coloured with erect aërial mucor-hyphæ or *stolons*. The fertile pedicels are branched and form a raceme or, more rarely, a corymb.

R. parasiticus is pathogenic to man [pulmonary rhizomucor-mycosis], rabbits, guinea-pigs and fowls.

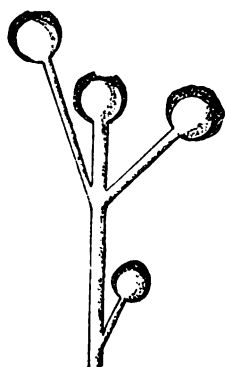

FIG. 320.—*Rhizomucor parasiticus*.
(After Lucet and Costantin.)

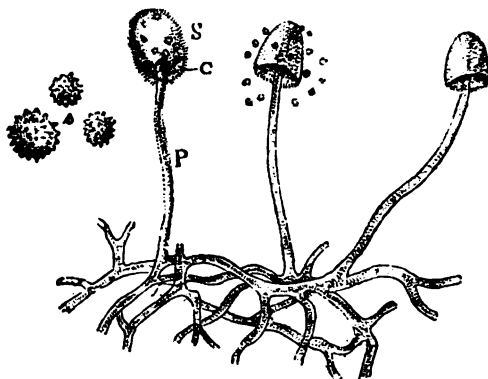

FIG. 321.—*Rhizopus nigricans*. P, pedicel; C, columella
S, sporangium.

SECTION IV.—THE GENUS RHIZOPUS.

1. *Rhizopus nigricans*.

Syn.—*Ascophora nigricans*.

R. nigricans is, according to Mégnin, a dangerous fungus, being responsible for most of the cases of illness following the consumption of mouldy foods. It does not seem, however, to be pathogenic.

Morphology.—*R. nigricans* forms blackish spots which consist of a very freely-growing, blackish-brown, highly-branched mycelium with internodes carrying spore-bearing hyphæ terminating in globular sporangia. When the sporangia (fig. 321 S.) burst, the envelope becomes inverted and the ovoid or irregularly rounded spores contained within it are set free.

2. *Rhizopus niger* seems to be merely a variety of *R. nigricans*. It has been recorded by Ciaglinski and Hewelke in certain cases of black tongue (p. 706).

3. *Rhizopus coхни* was found in the rabbit by Lichtheim. Its characteristic feature is the colour of the mycelium, which is at first white but later assumes a mouse-grey colour. It is pathogenic to rabbits.

4. *Rhizopus equini* was found in the horse by Lucet and Costantin. It is pathogenic to rabbits.

CHAPTER L.

PARASITES OF THE FAMILY GYMNOASCIDÆ.

Section I.—The genus *Tricophyton*.

General methods of examination, cultivation, etc.

A. *Endothrix* species, p. 682.

1. *T. tonsurans*, p. 682. 2. *T. sabourauds*, p. 684. Other species, p. 684.

B. Ecto-endothrix species, p. 685.

1. *T. mentagrophytes*, p. 685. Other species, p. 687.

Section II.—The genus *Epidermophyton*, p. 688.

Section III.—The genus *Microsporum*, p. 688.

1. *M. audouini*.

Section IV.—The genus *Achorion*, p. 690.

A. The human parasite,—*A. schenleini*, p. 690.

B. The parasites of favus in the lower animals, p. 692.

Section V.—The genus *Lophophyton*, p. 692.

Section VI.—Micro-organisms in *Alopecia areata*, p. 692.

Section VII.—The bacillus of *Seborrhœa oleosa*, p. 692.

[THE family of the Gymnoascidæ comprises many parasitic fungi. They are characterized by their conidial apparatus and by the fact that the asci are surrounded by a loosely felted perithecium.]

SECTION I.—THE GENUS TRICOPHYTON.

Grüby of Paris in 1842 was the first to demonstrate the presence of fungi in different forms of ringworm. Malmsten shortly afterwards independently described a parasite he had found in ringworm, [and the name *Tricophyton* is of his introduction].

Formerly, parasites of the genus *Tricophyton* were classified with the *Bothrytis*. They are now grouped with the genus *Achorion* in the family Gymnoascidæ (order Ascomycetes). The Tricophyta are closely related to *Microsporum audouini* (*Tricophyton microsporum*, Sabouraud) another species found in ringworm by Grüby. In cultures the Tricophyta produce spore-bearing hyphæ arranged in a raceme (conidial forms).

The investigations of Sabouraud have shown that a number of species of the genus *Tricophyton* is responsible for the ringworms of man and the lower animals.

In man, the Tricophyta infect the scalp (*Tinea tonsurans*), the beard (*Tinea sycosis vel barbæ*), the glabrous skin (*Tinea circinata*), the nails (onychomycosis), [and certain of the mucous membranes (mouth and vulva)].

Methods applicable to the *Tricophyton* parasites generally.

1. **Microscopical examination.**—The infected hairs should be examined after treating them with a 40 per cent. solution of potash in the warm (p. 690).

One preparation should be gently heated to show the situation of the parasite in relation to the hair. Another should be heated until the liquid just begins to boil in order to dissociate the hair and show the structure of the parasite.

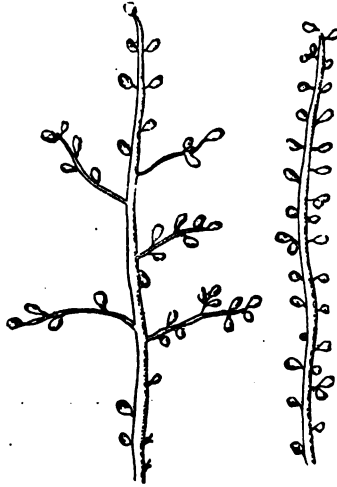

FIG. 322.—Culture of the white trichophyton from an horse. Conidia.
(After Bodin.)

Epithelial scales should be first teased with needles and then treated as above. For preparing stained preparations, Sabouraud selects thin scales, which should be washed with chloroform to remove the fat, then boiled for 2 or 3 minutes in formic acid, washed in distilled water and stained in Sahli's borax blue for 1 minute.

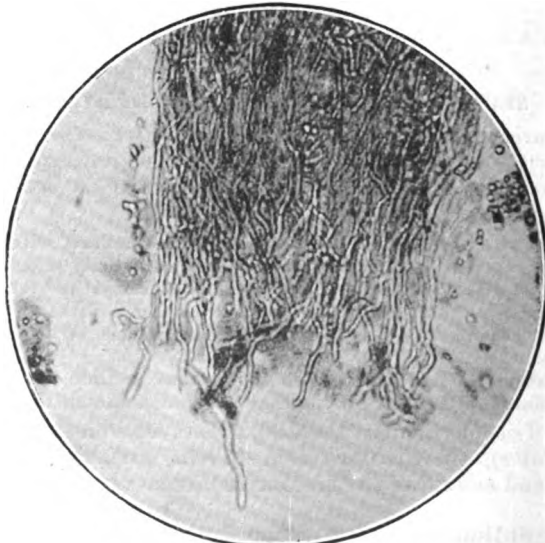

FIG. 323.—A ringworm-infected hair after treatment with caustic potash. Note the fringe at the junction of the shaft with the soft bulb. (From a photograph kindly lent by Dr. H. G. Adamson.)

Sahl's borax blue.

| | |
|---|-----------|
| Distilled water, - - - - - | 40 parts. |
| Saturated aqueous solution of methylene blue, - - - - - | 24 „ |
| 5 per cent. solution of sodium borate, - - - - - | 15 „ |

After staining, the preparation is differentiated in absolute alcohol, washed in xylol and mounted in balsam.

An hanging-drop preparation is the best method of studying the cultural characteristics of the parasites.

Place a drop of culture fluid on a slide, sow it with the parasite and then invert the slide on a Böttcher cell in such a way that the fluid is within the ring, and lute with paraffin. Incubate for 5 or 6 days and then examine under the microscope. To make a permanent preparation, after examining in the living state lift the slide from the cell, dry, fix with a drop of pure acetic acid, wash and stain with an aqueous solution of eosin. Wash. Dry. Mount in balsam.

2. Cultures.—The Tricophyta are strictly aërobic. Growth occurs at laboratory temperature but is more rapid at 33°–35° C.; at the higher temperatures, however, the culture soon becomes old and the morphology of the parasites is altered. Primary cultures are best made at the temperature of the laboratory. The Tricophyta cannot be cultivated on acid media. They grow readily on potato but best on media containing sugar and a little nitrogenous matter, and particularly well on beer-wort (180 per 1,000 of maltose), and the following solution (Sabouraud) :

Sabouraud's proof medium.

| | |
|---|-----------------|
| Crude maltose (Chanut), - - - - - | 4 grams. |
| Granulated peptone (Chassaing), - - - - - | 0·75 to 1 gram. |
| Distilled water, - - - - - | 100 grams. |

Sabouraud's medium may be solidified by adding 1·5 parts of agar per cent.

[In artificial culture the ringworm parasites are subject to great morphological variation both microscopical and macroscopical. So considerable are these pleomorphic changes that unless the fact be borne in mind a given species may easily be mistaken for another species of the same, or even of a different, genus. Once a culture has undergone a morphological variation there is no known method by which it can be made to reassume its original characteristics. To avoid as far as possible pleomorphic changes taking place in cultures Sabouraud advises the use of a medium containing no sugar on which to cultivate stock cultures. The medium is of the following composition :

Sabouraud's medium for stock cultures.

| | |
|---|-------------|
| Distilled water, - - - - - | 100 grams. |
| Granulated peptone (Chassaing), - - - - - | 3-5 „ |
| Agar, - - - - - | 1·8 grams.] |

The isolation of the parasites.—A diseased hair, the contents of a vesicle of tinea circinata, or a few drops of blood from the site of one of the lesions, all afford suitable material from which to isolate the ringworm parasites.

(i) **Cultures from blood.**—Cleanse the skin of the affected part and after lightly scarifying it collect a few drops of blood and spread the material on sloped tubes of Sabouraud's maltose agar.

(ii) **Cultures from vesicles.**—Adopting the necessary precautions to avoid contamination, remove the contents of a vesicle with a fine pipette or a platinum loop and sow the material on tubes of the same medium.

(iii) **Cultures from hairs.**—The parasite does not occur in pure culture in the lesions of ringworm, but is always mixed with five or six other species of

organisms. The following is the method advised by Sabouraud for isolating the parasite of ringworm from a diseased hair :

Break off one of the affected hairs, lay it on a sterile slide and, with a sterile cutting needle, divide it into as many pieces as possible. Sow each fragment on a tube of agar (beer-wort or Sabouraud's) containing a large percentage of maltose—a medium on which the other organisms accompanying the trichophyton grow badly. As soon as growth is visible, as indicated by a downy-looking speck at the site where the fragment of hair was sown, sub-cultivate on to another tube of the same medium ; after sub-cultivating two or three times in this way transfer a portion of the growth from the third or fourth sub-cultivation when about 20 days old to a slice of potato, rubbing it well over the surface of the medium. In this way single colonies are obtained. The various cultures should be grown at the temperature of the laboratory.

Král's method (p. 691) is also useful. The technique is more delicate but results are obtained more quickly than by Sabouraud's method.

Plaut advises laying the hair on a sterile slide, covering it with a cover-glass and, after fixing the angles of the latter with a little drop of wax, placing the preparation in a moist chamber. After about a week some of the spores will have germinated and produced a mycelium which can easily be collected for sowing culture media.

When sub-cultivating it is essential to pick up only a small portion of the growth, and for this purpose it will be found more convenient to use a steel needle than the ordinary platinum wire.

3. Experimental inoculation.—The trichophyta are pathogenic for man and the lower animals. The results of these experimental infections will be described when dealing *seriatim* with the different species.

[4. Classification of the Trichophyta.—The parasitic species of the genus trichophyton are divided into two large groups :

[1. *Trichophyton endothrix*.

[2. *Trichophyton endo-ectothrix* (or *ecto-endothrix*).

[Pathogenically, the endothrix species are confined to the inside of the hair, while the endo-ectothrix species grow both within and around the affected hair. The former are human parasites and infection takes place from man to man. The latter are invariably of animal origin ; man becomes infected by contact with a diseased animal, and the source of the infection is generally easy to trace.

[The endo-ectothrix species are sub-divided, according to the size of the "spores" of the parasite, into *Ectothrix microides* and *Ectothrix megaspores* and in each of these sub-divisions there are varieties or species differing from one another in cultural characteristics. The small-spored endo-ectothrix species give either a white, plastery-looking growth (*T. gypsum*) on the maltose test medium, or a white, downy growth (*T. niveum*). The large-spored endo-ectothrix species give either a velvety growth or a culture like the parasite of favus.

[The table on p. 683 modified from Guiart exhibits these points in tabular form.]

[A. Endothrix species.]

1. *Trichophyton tonsurans* (Malmsten).

Syn.—*Trichophyton megalosporum endothrix* Sabouraud ; [*T. crateriforme* Sabouraud.]

Trichophyton tonsurans grows inside the hair. The affected hair breaks off very short (3–4 mm. from the skin) is thicker than the uninfected hair and has no ring or collar encircling it. The hairs are very difficult to epilate and are occasionally decolourized. *Trichophyton tonsurans* is responsible for

a large percentage (42 in France, [in London, according to Colcott Fox, 38]) of the scalp Tricophytoses of children.

| GENUS. | VARIETIES. | MICROSCOPICAL APPEARANCE. | TYPES. | | CLINICAL MANIFESTATIONS. | |
|--------------|---|--|---|-------------------|--|--|
| Tricophyton. | Endothrix. Human origin occurs especially in children. 72 per cent. of cases of tricophyton ringworm. 10 per cent. of cases of herpes circinata. | Resistant mycelium with square spores. | T. tonsurans vel crateriforme. | | Hair breaks off long. 42 per cent. of cases. | |
| | | Fragile mycelium with round spores. | T. sabouraudi vel acuminatum. | | Hair breaks off short. 30 per cent. cases. | |
| | Ectothrix. Animal origin occurs especially in the adult. 28 per cent. of cases of tricophyton ringworm. 90 per cent. of cases of herpes circinata. | Ectothrix microides. | Fragile mycelium with small round spores. | T. gypseum group. | T. mentagrophytes | Suppurative conditions (Kerion and Sycosis). |
| | | | | T. niveum group. | T. felineum. | |
| | | Ectothrix megaspores. | Fragile mycelium with large round spores. | Velvety growth. | T. equinum. T. megnini. | |
| | | | | Faviform culture. | T. verrucosum | |

1. **Microscopical appearance.**—After treating with potash (p. 690) or dissociating in a drop of acetic acid and mounting in glycerin, the affected hair will be seen on examination under the microscope to be filled with numerous spores (pseudo-spores p. 691): it is uncommon to find filaments. The parasite can be recognized by the following characters:

(a) The pseudo-spores are arranged in chains: they measure 5–6 μ in diameter and in shape are round or cubical with blunted angles.

(b) The whole of the hair is infected with the mycelial spores.

(c) The mycelial filaments show at the most two bifurcations, the “ tarsal ” appearance is never seen (p. 691).

(d) The parasite is entirely within the hair.

(e) The mycelium can only be broken up and then with difficulty in a 1 in 40 solution of potash (resistant mycelium).

2. **Cultural characteristics.**—*Tricophyton tonsurans* forms a continuous cream-coloured felted mass on the surface of the medium on which it is growing, with fine thread-like prolongations radiating from the centre to the periphery. On maltose-agar the centre of the growth is depressed in the form of a flat-bottomed cupule, the inner sides being perpendicular the outer sloping [*T. crateriforme*]. On beer-wort agar (one-half) it forms a

circular yellow growth with raised powdery centre. On potato numerous small yellowish and powdery star-shaped growths appear.

In cultures on media containing maltose, *Tricophyton tonsurans* gives origin to a mycelium with spore-bearing hyphæ arranged in racemes. In ordinary peptone media the growth is less luxuriant and the morphology is the same as in human lesions.

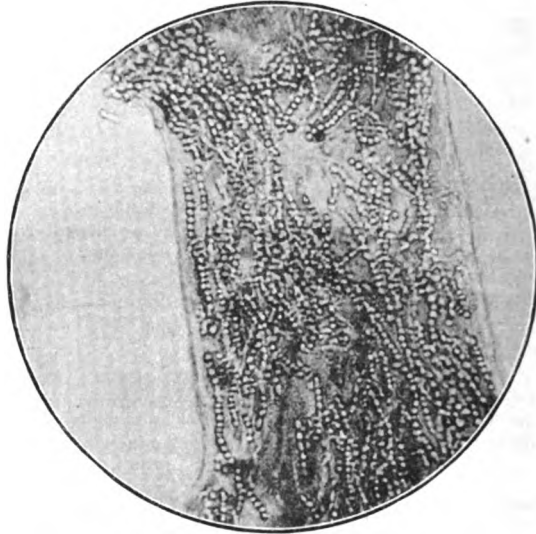

FIG. 324.—*Tricophyton* from a case of "conglomerate folliculitis." (*T. megalosporum ectothrix*.) The hair shaft is filled with spores in chains. (From a photograph kindly lent by Dr. H. G. Adamson.)

3. Experimental inoculation.—It is difficult to infect man because the cutaneous secretions are acid in reaction and the parasite will not grow in an acid medium (Verujsky). To ensure infection the patient should be given 15–20 grams of sodium bicarbonate to render the perspiration alkaline. Another means of producing infection is to cauterize the skin with the red-hot end of a match which has been extinguished; this forms a small vesicle containing a drop of serum which is neutral in reaction, and on the following day the parasite can be inoculated into the vesicle.

The infection of animals (guinea-pigs, rabbits and cats) is also somewhat difficult. After pulling out the hairs from a small area of the skin on the back scarify the latter and rub in the culture. The lesion heals spontaneously in 5–6 weeks.

2. *Tricophyton sabouraudi*.

[Syn.—*Tricophyton acuminatum* Bodin.]

T. sabouraudi (Blanchard) corresponds to the *T. endothrix* with "fragile mycelium" of Sabouraud. It occurs only in the hair.

Tricophyton sabouraudi is the cause of the alopecia-like ringworm of children [Colcott Fox found *T. sabouraudi* in 26 per cent. of cases of scalp trichophytosis in children]. The affected hair breaks off level with the skin and is very difficult to epilate. Microscopically the hair is crammed with rounded pseudo-spores which escape from the broken surface of the hair "like billiard balls out of a bag" (Sabouraud). The mycelium is composed of moniliform cells, and is easily dissociated in potash (fragile mycelium).

The growth on beer-wort agar and on maltose-agar assumes the form of a projecting cone with a wide base and traversed by deep sulci passing from the apex to the base: the colonies are creamy-white in colour and tinted with pinkish-grey or greyish-brown circles. On potato the parasite grows as a straight brown streak and is covered with a very fine light brown powder.

3. *Tricophyton violaceum*.

[*T. violaceum* occurs in 15 per cent. of cases of trichophytic ringworm in children in London (Colcott Fox). It is characterized by the violet colour of the culture when about 3 weeks old. The culture is more or less acuminate.]

4. *Tricophyton sulphureum*.

[This trichophyton seems to be peculiar to England, for while Colcott Fox found it in 21 per cent. of cases of scalp ringworm in children due to trichophyta in London it is rare in France, and four cases seen by Sabouraud were imported from England. The culture resembles the crater-like form of *T. tonsurans*, and is sulphur-yellow in colour.]

[B. The Endo-ectothrix species.]

1. *Tricophyton mentagrophytes*.

[Syn.—*Tricophyton gypseum* Bodin; *Tricophyton asteröides* Sabouraud.]

This parasite which gives a white growth in culture, and is described by

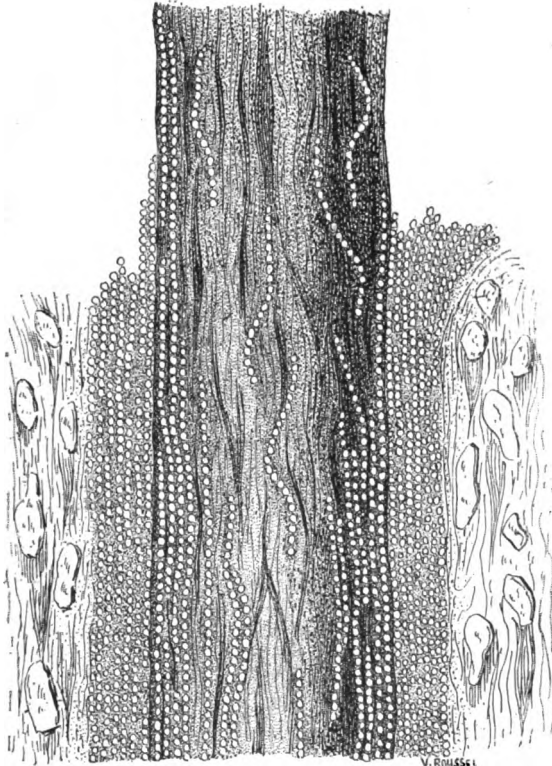

FIG. 325.—*Tricophyton mentagrophytes* (Endo-ectothrix). Hair from the beard. (After Sabouraud.)

Sabouraud as *Tricophyton ectothrix* or *Tricophyton pyogenes*, is of animal origin. In the horse it causes a suppurating folliculitis. In the human adult it produces sycosis or mentagra and onychomycosis: in children it gives rise to tinea kerion.

Tricophyton mentagrophytes is pyogenic and the lesions are accompanied by dermatitis.

It is an endo-ectothrix parasite and grows both within and outside the hair, forming a sort of collar around the base and affecting the epidermal covering of the skin more than the hair itself. The infected hairs are broken and somewhat bent at the free end giving to the affected area a rather characteristic untidy appearance.

1. Microscopical appearance.—In order to find the parasite the small downy hairs at the periphery of the affected area should be examined, and not the dead full-grown detached hairs. Epilate the downy hair together with the epidermal cone from which it emerges and treat with potash. On examining the preparation under the microscope it will be seen that the mycelial spores form a compact mass in the epidermal covering of the hair. The spores of *T. mentagrophytes* are, as a rule, larger than those of *T. ectothrix*: some may reach a diameter of 15–18 μ .

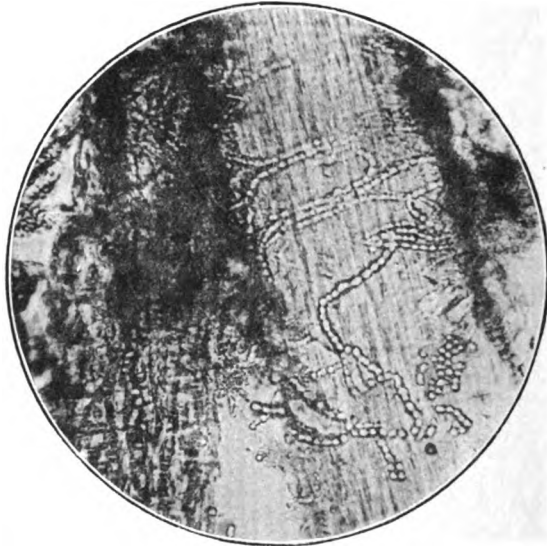

FIG. 326.—Unstained preparation of large-spored ringworm (*T. megalosporum* endo-ectothrix). The fungus is outside the hair. (From a photograph kindly lent by Dr. H. G. Adamson.)

When the parasite cannot be found on the hair the pus from a vesicle which has not yet opened should be collected and a small drop examined unstained. In the pus, a small number of spores having the same characters as those in the hair will be seen; by using an Abbe condenser a quantity of very slender and very short mycelial debris can be found which would escape observation when only ordinary light is used. It is difficult to stain preparations satisfactorily: fuchsin and eosin give the best results.

2. Cultural characteristics.—On beer-wort agar, which is the best medium, the culture forms in the first instance a fine white downy tuft which after

increasing in size becomes umblicated in the centre and is surrounded with star-like rays; at the end of a week it is covered with a white, chalky dust and in a fortnight the downy appearance is again seen in the centre.

On maltose-agar a white disc is formed downy in the centre, powdery and godrooned at the margins.

On potato, a large white track at first downy, later chalky, is produced.

T. mentagrophytes gives a white growth on whatever medium it is grown: this fact is of importance since all species of *Tricophyton* which give white growths are pyogenic.

Tricophyton mentagrophytes can live as a saprophyte and grows readily on garden mould, mulberry leaves, etc.

3. Experimental inoculation.—*Tricophyton mentagrophytes* is pathogenic for man and guinea-pigs. Infection of the guinea-pig is easy; it is only necessary to pick up a little of the growth in the teeth of a pair of pressure forceps and then to pinch the animal's skin between the teeth of the forceps. This method of inoculation gives rise to a serpiginous tricophytosis which persists indefinitely but is unaccompanied by suppurative folliculitis (Bodin).

2. *Tricophyton equinum*.

Tricophyton equinum was isolated by Matruchot and Dassonville during an epizootic of equine herpes which was contagious for man, horses, guinea-pigs and rabbits. *T. equinum* belongs to the endo-ectothrix sub-division. On agar it produces colonies which are white on the surface, but yellow or red in the depth. It grows with difficulty on potato.

3. *Tricophyton caninum*.

This parasite was described by Matruchot and Dassonville as occurring in ringworm of dogs. It is an ectothrix parasite with round, ovoid or elongated spores. On sugar-agar, it gives a flocculent white growth. On potato, small golden-yellow colonies. This species is infective for dogs and guinea-pigs.

4. *Tricophyton felineum*.

[Syn.—*Tricophyton niveum* Sabouraud · *T. radians* Sabouraud.]

This parasite was found in ringworm in cats, and is infective for man and most of the domestic animals: in man, it produces *tinea circinata dysidrosiforme* (Sabouraud). It is an ectothrix parasite and pyogenic: in cultures it resembles *T. mentagrophytes*.

5. *Tricophyton megnini*.

Tricophyton megnini is the cause of a severe tricophytosis among the Gallinacæ. It may infect the human hair, in which it grows in the deeper layers in the form of numerous large spores and in the superficial layers as fine mycelial filaments forming a network around the hair.

Cultures grow very slowly and have generally a ragged-white-disc appearance more or less radiated.

6. The faviform tricophyta.

These are the parasites (described by Bodin) which produce lesions with distinct ringworm characteristics, but in cultures behave like parasites of the genus *Achorion*; they form indeed an intermediate group between the two genera. *T. faviforme* of the ass and of the horse are transmissible to man.

[7. *Tricophyton concentricum*.

[Syn.—*Tricophyton mansonii* Castellani: *Endodermophyton concentricum* Blanchard.

[It is uncertain whether *tinea imbricata* (p. 700) is due to infection with a species of *Aspergillus* or whether it is a true ringworm disease. According to Manson the parasite causing the disease is a tricophyton.

[This uncertainty arises because it is doubtful whether the organs of fructification seen by Tribondeau, Jeanselme, and Wehmer are accidental contaminations due to a saprophyte growing symbiotically with the true parasite of the disease or whether the filaments and fructifications are all part of one and the same parasite. The description of the parasite as seen in the lesions is given at p. 700.]

[Nieuwenhuis has cultivated a parasite in every way resembling a *Tricophyton* by sowing epidermal scales freshly taken from the lesions, and with these cultures has succeeded in reproducing the disease in man. Tribondeau with cultures of his *Aspergillus* has infected himself with the disease.]

[Castellani has also been able to cultivate the *Endodermophyton concentricum* and an allied species *E. indicum* and in both instances has reproduced the disease by experimental inoculation of his cultures.]

[The aetiology of tinea imbricata must therefore be considered undetermined: further research is necessary to definitely solve the question (Brumpt).]

SECTION II.—THE GENUS EPIDERMOPHYTON.

Epidermophyton cruris.

[Syn.—*Epidermophyton inguinale*.]

Ringworm in the groin [*Eczema marginatum*, *Tinea marginata*, *Tinea cruris*] is due to a parasite, described by Sabouraud, *Epidermophyton cruris*,¹ closely resembling the other ringworm parasites in many of its characteristics, but differing from them in that it always remains limited to the stratum corneum of the epidermis and never attacks the hair.

Epidermophyton cruris forms a network of mycelium filaments composed of quadrangular cells arranged end to end growing horizontally between the cells of the stratum corneum.

The parasite grows on Sabouraud's medium but produces no racemes of spores. Attempts to experimentally infect man and the lower animals have not been successful.

[SECTION III.—THE GENUS MICROSPORUM.]

1. Microsporum audouini.

Microsporum audouini was first seen by Gruby, who found it in an anomalous parasitic disease of the hair which he called *prurigo decalvans* (bald ringworm), and which was subsequently confused with alopecia and tricophytosis.

Sabouraud, however, cleared up the difficulty and showed that the disease which he calls *teigne tondante rebelle* or *teigne tondante* of Gruby—bald ringworm—[and which is characterized by the presence of smooth bare spots of greater or less extent] is caused by infection with a microsporum. The parasite is properly designated *Microsporum audouini*, and not *Tricophyton microsporum* as Sabouraud originally described it, since it differs from the *Tricophyta* both in its appearance in the affected hairs and in its mode of growth in artificial culture (Bodin).

[*Microsporum audouini* is the cause of 90 per cent. of juvenile ringworm in London (Malcolm Morris).] It does not grow on the glabrous skin, but only on the hair. Hairs infected with *M. audouini* have a characteristic appearance: they break off 6 or 7 mm. from the skin, have lost their colour, are very thin, and are covered with the parasite which imparts to them a smooth, grey appearance as though they were sprinkled with a blue dust.

Bodin has described two varieties of *Microsporum audouini*.

M. audouini var. *canis* is the cause of a ringworm in the dog; it is transmissible to man and produces a condition similar to the bald ringworm of Gruby; inoculated on the guinea-pig it leads to a ringworm which resolves spontaneously in a few weeks.

[¹ *E. cruris* is the cause, in some cases, at least, of Dhobie itch.]

M. audouini var. *equinum* is the cause of the contagious herpes of colts. In cultures it is highly pleomorphic. It is infective for horses, guinea-pigs and dogs. The parasite may develop on man and produce small, transient, erythematous lesions.

[*Microsporium felineum* is parasitic on the cat and may be transmitted to both children and adults. It grows with great rapidity in artificial culture, and is characterized by the flat disc-like appearance of its culture with a small central raised button marking the site of inoculation of the medium. Cats, dogs, and guinea-pigs are easily infected experimentally.]

1. **Microscopical appearance.**—An infected hair after being treated with potash (p. 690) will be seen to be covered with a mosaic of "mycelial spores": these spores measure 1–3 μ in diameter, are round or polyhedral from mutual pressure, irregularly agglomerated, never arranged in chains, and possess a clear transparent envelope (fig. 327). The "spores" never penetrate into the interior of the hair.

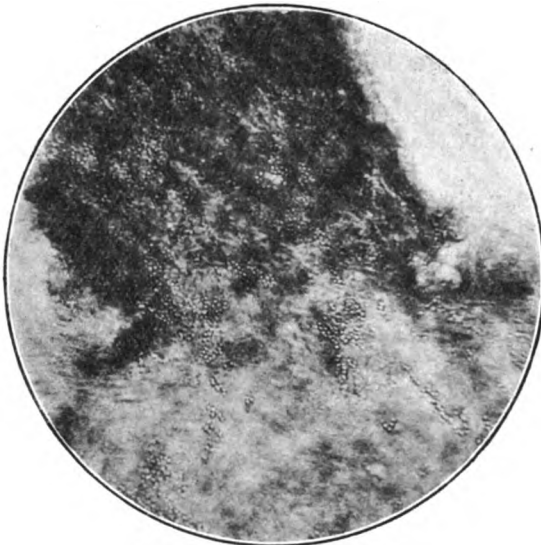

FIG. 327.—*Microsporium audouini*. Photograph of an hair showing spores forming a sheath around the shaft. (Kindly lent by Dr. H. G. Adamson.)

Microsporium audouini grows on the hair from above downwards: the older the lesion the more deeply does the parasite sink into the part around the root of the hair.

2. **Cultural characteristics.**—Lay an hair on a sterile slide, cut it into very short lengths, and sow each piece on a separate tube of one of the media used for the cultivation of the Tricophytons. In the majority of cases a pure culture will be obtained in the primary growths.

Potato.—On potato the growth of *M. audouini* is characteristic. After 7–8 days a grey streak is visible which tends to change its colour to reddish-brown as time elapses and about the tenth to the twelfth day small bouquets of a scanty short down appear here and there. The fungus retains its vitality on potato for several months; under similar conditions the tricophyton dies in 18 days.

Beer-wort-agar.—After 3–4 days tufts of the mycelium strike out and grow into the substance of the medium, taking the silky appearance of

2 x

poplar seeds: then from the centre of the colony a tuft of downy aërial hyphæ emerges, forming around the growth a number of glabrous concentric circles which ultimately become slightly downy. The growth is white.

In these cultures the mycelial filaments are at first short, but later elongate, producing a tangled mass and becoming swollen into club-shaped swellings. After a few days the ends of the mycelial filaments throw out long filaments twisted like the lash of a whip, on which lateral thickenings appear carrying a series of teeth like the teeth of a comb. These are abortive forms of branches. When the parasite is grown on unsuitable media certain of the filaments with club-shaped swellings become isolated by a transverse constriction; their contents become granular and their walls thicken thus forming organs of resistance or chlamydo-spores. In cultures on suitable media fructification by fusiform or cylindrical conidia occurs at about the end of a week.

3. Experimental inoculation.—*Microsporium audouini* appears to be a strictly human parasite. Experimental infection of children, whose scalp is the most favourable situation for the growth of the parasite, is not feasible on account of the contagiousness and chronic nature of the disease. Generally speaking, the lower animals are immune to infection (Bodin), but in a few cases the disease has been reproduced in rabbits, guinea-pigs and horses (Courmont).

The varieties found in the spontaneous ringworms of the dog and young horse are infective for the lower animals.

SECTION IV.—THE GENUS ACHORION.

A. The parasite of favus in man.

Achorion schönleini.

Schönlein showed that favus¹ is caused by a fungus² belonging to the genus *Achorion*.

Achorion schönleini may infect any of the epithelial tissues—the hair of the scalp, the skin, the nails; in one case seen by Kaposi and Kundrat the parasite had infected the mucous membrane of the œsophagus, stomach, and intestine. As a rule the infected hair projects from a small cup-like depression in the centre of the characteristic sulphur-yellow disc or *scutulum*. The hair is discoloured almost up to its point of emergence, and does not break in the forceps but comes out entire.

According to Bodin, Neebe and Unna several species of *Achorion* are found in human favus all very closely related to one another. Many observers on the other hand hold that there is but one species.

Attempts to infect the lower animals have given inconstant results. Sabrazès says that he has produced a pseudo-tuberculous condition by inoculating a spore-bearing culture of *Achorion* into the peritoneal cavity of a guinea-pig.

Morphology and methods of detection.

1. Microscopical appearance.—Immerse the hair in a drop of 40 per cent. potash on a slide and cover with a cover-glass. Heat carefully over the pilot flame of a Bunsen until the potash solution just begins to boil, then lay the slide on a cold surface to stop the process of dissociation and examine at once with a low eyepiece and dry lens; the potash clears the hair and the parasite can be readily seen.

To make permanent preparations treat with potash as above and then run a little drop of eosin-glycerin under the cover-glass. Hairs which have been boiled in

[¹ The disease is so called from its resemblance to an honeycomb (*L. favus*).

[² This perhaps is not strictly true. Schönlein undoubtedly found a fungus in association with favus but it seems that Gruby, who independently discovered the fungus, was the first to actually show the relation of cause and effect.]

potash must never be washed in water because contact with water would reduce them to powder at once.

In favus-infected hairs treated with potash numerous mycelial threads will be seen, and in addition very short, occasionally rounded, bodies—pseudospores, or *mycelial spores*—which are resistant forms, and not true spores or conidia which are only produced in cultures.

The mycelial filaments which are arranged along the axis of the hair are delicate knotted and simple, or provided with two to four branches. The pseudospores are 3–7 μ in diameter, rounded or slightly flattened; they do not infiltrate the whole of the hair but form branched chains separated from one another.

The parasite passes through the epithelium to reach the dermis: it destroys the hair papilla and causes the hair to fall out. In the neighbourhood of the favus cup there is an hypertrophy of the epithelial cells and, in the midst of these, masses of mycelium agglutinated together with an amorphous glairy substance. To study the parasite in the scutulum, crush up one of the scabs between two slides and treat the powder with caustic potash as described above. A scutulum may be embedded in paraffin, cut and stained in gentian-violet or Unna's polychrome blue.

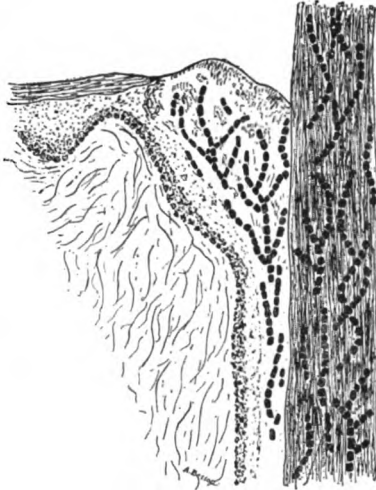

FIG. 328.—Vertical section through an hair with a portion of a favus cup.

The parasite has the following characteristics in the hair :

- (a) There is no visible envelope. As a matter of fact an envelope exists but it is very refractile and difficult to make out.
- (b) The mycelium has a knotted appearance and the filaments composing it are wavy.
- (c) The parasite never affects the whole of the hair.
- (d) The filaments divide into three or four branches resembling the bones of the human tarsus (*tarse faviqne*).

2. Cultural characteristics. Conditions of growth.—*Achorion schenleini* is distinguished from the moulds and resembles the trichophyta in that it does not grow on acid media (Duclaux and Verujski); a degree of acidity exceeding 0.3 gram of tartaric acid per litre is sufficient to completely arrest growth. To obtain a culture of the parasite a medium rich in peptone must be used; most carbohydrates are unsuitable: glycerin (broth or agar) and mannite are the best. The parasite is aerobic. Growth begins at 15° C., the optimum temperature is 33° C.; at 38° C. growth ceases.

The appearances presented by *Achorion schenleini* in culture are not at all characteristic: they vary even when the same strain is grown on the same medium.

Achorion schenleini is not present in pure culture in the lesions of favus and in order to isolate it in pure culture Král's method should be adopted. Grind up a little piece of the scutulum in a sterile ground-glass mortar with a little sterile powdered silicic acid. Plate the powder on gelatin in Petri dishes, examine the plate before incubating and mark the spots where single spores have been sown, then incubate the plate and subsequently pick off the colonies which develop in the situations marked.

Characters of growth. Agar.—On agar, a yellow brown wrinkled layer is formed with a depression in the centre like the cup-shaped depression on the scalp.

Sabouraud's medium is better than ordinary agar.

| | | | | | | | |
|---------------------------------|---|---|---|---|---|-----|--------|
| Granulated peptone (Chassaing), | - | - | - | - | - | 2 | grams. |
| Pure anhydrous glycerin, | - | - | - | - | - | 4 | " |
| Agar, | - | - | - | - | - | 1.5 | " |
| Distilled water, | - | - | - | - | - | 100 | c.c. |

Potato.—A dry, raised, mammillated layer brownish-grey or brown in colour appears about the fourth to the fifteenth day. The potato turns brown.

Broth.—Growth takes the form of a large spreading colony floating on the surface of the medium. The colony has the same appearance as a growth on agar.

B. The parasites of favus in the lower animals.

The parasites found in favus in some of the lower animals are related to, but are not identical with, *Achorion schœnleini*.

1. *Achorion quinckeannum*.—Favus in mice is caused by *Achorion quinckeannum*. In the lesions, the parasite forms mycelial filaments of varying length consisting of rectangular or ovoid cells: the filaments break up into short rectangular bodies which constitute the spores. The parasite grows readily at 35° C. on media containing glucose or glycerin. It is pathogenic to guinea-pigs and mice and gives rise to scutula when a week-old culture on agar is inoculated on a lightly abraded area of the skin.

2. *Achorion arloingi*.—*A. arloingi* was found in a case of a ringworm-like disease by Désir de Fortunet. It is pathogenic to mice, rabbits and man.

3. *Oospora canina*.—Favus in dogs is due to a related fungus, *Oospora canina* (Costantin and Sabrazès).

SECTION V.—THE GENUS LOPHOPHYTON.

Lophophyton gallinæ.

Favus in fowls is caused by *Lophophyton (Epidermophyton) gallinæ* (Mégnin). [This parasite can be made to infect man in which case it does not produce the cup so characteristic of favus but large erythematous patches.]

SECTION VI.—MICRO-ORGANISMS IN ALOPECIA AREATA.

A large number of cases of alopecia are now acknowledged not to be of a parasitic nature. In ordinary alopecia numerous observers including the author have consistently failed to detect any specific infecting agent. Whatever the aetiology of alopecia, and there is probably more than one cause (tropho-neurotic alopecia, etc.), it must be admitted that micro-organisms rarely play any part in the causation of the disease.

It is possible that some cases of pseudo-alopecia are due to the coccus described by Vaillard and Vincent.

SECTION VII.—THE BACILLUS OF SEBORRHOEA OLEOSA.

[*The micro-bacillus of the "peladic utricule" in alopecia areata.*]

Sabouraud described a bacillus as being present in seborrhœa oleosa. The pathogenic rôle of the organism is not yet fully understood, but it does not seem to play the part in the causation of alopecia which he thought he was justified in attributing to it.

Methods of examination.—Remove one of the crusts, scrape it with the edge of a slide and prepare films with the oily material scraped off.

Wash the films in ether to get rid of the fatty substances, stain by Gram's method, or, more simply, with blue, fuchsin, or carbol-violet. The preparations show numerous very fine bacilli in pure culture (fig. 329).

In young cultures the bacillus is punctiform and very like a coccus: in older cultures the organism is more obviously a bacillus and measures about $1 \times 0.5\mu$: the organism stains readily with the basic aniline dyes, or the ordinary solutions containing a mordant can be used. It stains by Gram's method.

Cultures.—It is difficult to raise a culture of the organism with material from seborrhoea of the scalp or from a comedo. The bacillus, like all skin bacteria, requires an acid medium: on the following medium its cultivation is "almost easy."

| | |
|----------------------------|-------------|
| Peptone, - - - - | 20 grams. |
| Glycerin, - - - - | 20 " |
| Glacial acetic acid, - - - | 5 drops. |
| Water, - - - - | 1000 grams. |
| Agar, - - - - | 13 " |

The agar is distributed into tubes and sloped.

To sow cultures from the tissues, wash the affected area of the skin with ether, then scrape it vigorously with the sharp edge of a sterile slide and sow the sebum on the surface of the medium. A large quantity of the material should be sown on each tube. On a few of the tubes, among a number of casual denizens, one or two pure colonies of the bacillus will be obtained.

At 35° C. the colonies become visible about the fourth day and, provided the medium contain glycerin, assume a rather characteristic appearance, being brick-red in colour and in shape like a pointed cone.

In the original cultures, colonies of Sabouraud's bacillus are always accompanied by other species of micro-organisms, a white coccus, *Staphylococcus cutis communis*, *Bacillus asciformis* (*Flaschen bacillen* of Unna), etc. To obtain a pure culture of the seborrhoea bacillus, Sabouraud advises leaving the sebum for 2 months between two sterile slides or heating it for 10 hours to 65°-67° C. before sowing cultures. By this means the organisms accompanying it are killed but the bacillus itself is not destroyed.

Experimental inoculation.—Attempts to reproduce the disease in animals invariably fail.



FIG. 329.—Bacillus of *seborrhoea oleosa*. Seborrhoeic exudate. Carbolthionin. (Oc. II, obj. $\frac{1}{14}$ th, Reich.)

CHAPTER LI.

PARASITES OF THE FAMILY PERISPORACIDÆ.

Introduction.—General methods of examination, cultivation, etc.

Section I.—The genus *Aspergillus*, p. 695.

1. *Aspergillus glaucus*, p. 695. 2. *Aspergillus repens*, p. 695. 3. *Aspergillus malignus*, p. 695. 4. *Aspergillus fumigatus*, p. 695. 5. *Aspergillus pictor*, p. 698.

Section II.—The genus *Sterigmatocystis*, p. 699.

1. *Sterigmatocystis nidulans*, p. 699. 2. *Sterigmatocystis nigra*, p. 699.

Section III.—The genus *Penicillium*, p. 700.

1. *Penicillium glaucum*, p. 700. 2. *Penicillium minimum*, p. 700.

Section IV.—The parasite of *Tinea imbricata*, p. 700.

THE family of the Perisporacidæ comprises numerous saprophytic species some of which may become parasitic. They are characterized by their septate mycelium, their conidial apparatus and by their asci surrounded by a complete perithecium.

General methods.

1. Microscopical examination. (a) **Of cultures.**—Crookshank recommends the following method:—

Place a drop of glycerin on a slide and a drop of alcohol on a cover-glass, introduce the fragments of the fungus into the alcohol, invert the cover-glass on to the slide and heat the latter over a small flame until bubbles just begin to appear, allow to cool and lute the edges of the cover-glass with paraffin. To make a permanent preparation of an hanging-drop culture, after examining it in the fresh condition replace the drop of culture fluid with a drop of acetic acid, blot up the acid with a piece of filter paper, stain with a 1 per cent. solution of safranin or eosin and mount in glycerin (also p. 676).

(b) **Of infected tissues.** i. **Films.**—Films of pus, sputum, etc. should be fixed in alcohol and stained with a 1 per cent. solution of safranin or with carbol-thionin.

ii. **Sections.**—Stain sections by the method described at p. 675.

The method of Rénon is useful for species which do not stain well by Gram's method. Stain for several minutes with carbol-thionin, wash quickly in distilled water, then in absolute alcohol, pass through oil of cloves and xylol and mount in balsam.

Gaucher and Sergent stain these parasites in Ehrlich's violet for 24 hours then in Gram's iodine solution for 5 minutes, decolourize rapidly in absolute alcohol, aniline oil, wash in xylol and mount in balsam.

2. Cultures.—The Perisporacidæ grow best on media of an acid reaction and on media containing sugars. They are aerobic organisms. The optimum

temperature of growth varies from 15°–37° C. according to the species. The best media to use are: diluted beer-wort, Raulin's liquid medium (p. 38), milk, gooseberry-juice, peptone-broth containing sugar and glycerin, potato, moist bread, and agar or gelatin made with beer-wort or Raulin's medium, etc.

These fungi may be isolated on plates of gelatin or agar made with Raulin's medium. The method described for the isolation of the *Mucoracidæ* is also applicable. Cultures in cells can be prepared as described on p. 675.

3. Experimental inoculation.—The pathogenicity of the different species varies considerably: the amount of disease produced depends also upon the number of spores inoculated. Birds are the most susceptible of all animals to the inoculation of parasites of this genus, then come rabbits, guinea-pigs and monkeys. It is best to inoculate the material directly into a vein but infection also follows intra-peritoneal, sub-cutaneous and other forms of inoculation. The lesions differ according to the species inoculated but generally speaking partake of the nature of a pseudo-tuberculosis.

SECTION I.—THE GENUS ASPERGILLUS.

The genus *Aspergillus* is characterized by non-septate spore-bearing hyphæ swollen at the tip. The swollen end is covered with short branches or *sterigmata* each terminating in a row of *conidia* (fig. 330). The arrangement of the conidial apparatus resembles the inflorescence of an onion.

1. *Aspergillus glaucus*.

Syn.—*Aspergillus herbariorum*.

This fungus is very widely distributed in nature. It is often seen as green spots on decomposing organic matter. It does not appear to be pathogenic though some observers think they have found it in birds: possibly in those cases the fungus was mistaken for a variety of *Aspergillus fumigatus* (Pinoy). It grows at low temperatures, but cannot be cultivated in the warm incubator (37° C.). The spores are large (8–15 μ in diameter).

2. *Aspergillus repens*.

This species is very closely related to the foregoing from which it is distinguished mainly by the smaller size of its spores (4–8 μ in diameter). It has been found in the wax which sometimes accumulates in the external auditory meatus (Siebenmann). It does not appear to have any pathogenic property.

3. *Aspergillus malignus*.

This species was found by Lindt in the ear of a man. It is pathogenic for rabbits. Growth takes place at 35°–37° C.

The swelling on the conidial hyphæ is pear-shaped and not, as in the two preceding species, spherical, and for two-thirds of its area is covered by undivided *sterigmata* carrying chains or rows of *conidia* greenish-white in colour and measuring 3–4 μ in diameter.

4. *Aspergillus fumigatus*.

Laulanié has shown that *Aspergillus fumigatus* is capable of producing a condition of pseudo-tuberculosis when inoculated experimentally into animals.

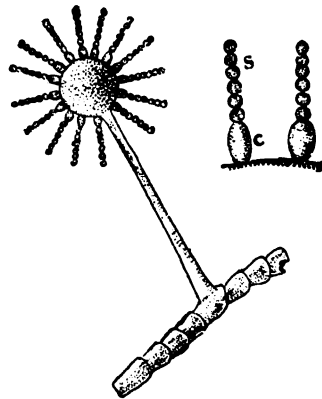

FIG. 330.—*Aspergillus glaucus*.

Cases of pseudo-tuberculosis due to an *Aspergillus* have also been recorded by several observers as occurring in the human subject. *Aspergillus fumigatus* has been found in infections of the ear and naso-pharynx, and in cases of keratitis with hypopyon following wounds of the eye caused by vegetable tissues.

Pigeon-crammers are very subject to aspergillary pseudo-tuberculosis. In pigeons there is often a "chancro" on the buccal mucous membrane due to an *Aspergillus*. The disease is also found in hair-combers who use flour of rye—which is often infected with spores of *Aspergillus*—for removing the grease from hair. In human aspergillary pseudo-tuberculosis the fungus is often associated with the tubercle bacillus. *A. fumigatus* has also been found in the lesions of pneumo-mycosis in the horse and cow. Rénon has found that by sowing millet seeds, vetch, oats, maize, wheat, and other varieties of corn on appropriate media cultures of various species of *Aspergillus* can be obtained the commonest being *A. fumigatus*.

1. Experimental inoculation.—Pigeons, rabbits, guinea-pigs and monkeys, are susceptible to infection with *A. fumigatus*. Dogs and cats, on the other hand, seem to be immune.

Pigeons are the best animals for purposes of experimental inoculation. The inoculation of 2–3 c.c. of a culture on Raulin's medium into the axillary vein leads to the death of the pigeon in 2 or 3 days. A dose of 1 c.c. produces a disease which runs a longer course ending in death in about a fortnight. By passage through pigeons the virulence of the parasite can be raised (Kotlair).

When death occurs soon after inoculation, the naked eye lesions in the pigeon are very scanty: tubercles will be found in the liver, but the lungs and spleen appear simply hyperæmic. When the disease is of longer duration, numerous tubercles can be seen with the naked eye in the internal organs: these are especially well marked in the liver and may show all the stages of development of a typical tuberculosis—(miliary tubercles, caseous degeneration and fibrous changes).

Microscopical examination too shows that the lesions bear a close general resemblance to those of true tuberculosis but in all of them a thick felting of mycelium and spores is visible.

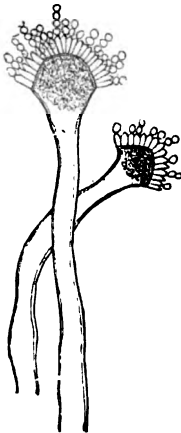

FIG. 331.—*Aspergillus fumigatus*. Fructification.

2. Morphology. Microscopical appearance.—*Aspergillus fumigatus* consists of a filamentous mycelium with hyphæ projecting from it at right angles, these latter are swollen into club-shaped masses (spore-bearing hyphæ) carrying undivided *sterigmata* into which chains of *conidia* are inserted: the conidia are rounded, smooth, of a brown or green colour and readily dehisce; they measure about 3μ in diameter. In sputum, a more or less dense felted mass of mycelium is found.

Staining reactions.—*Aspergillus fumigatus* stains well with the aniline dyes and is gram-positive providing that the staining is prolonged.

Cultural characteristics.—*Aspergillus fumigatus* grows best in Raulin's liquid or beer-wort. It is strictly aerobic and grows at all temperatures between 22° and 40° C.

In broth.—Growth is very slow and scanty. Flakes of mycelium are found floating in the medium which remains clear. It is very uncommon to find spores under these conditions.

In Raulin's medium.—Growth is abundant: numerous flakes are seen after incubating for 15 hours at 37° C. In the culture tangled masses of filaments and very numerous fructifications will be seen on microscopical

examination. The surface of the culture is at first velvety and white then bluish-green, blackish-green and finally, after 5 or 6 days, blackish-brown.

On gelatin.—Very small flakes slowly make their appearance along the line of sowing: a few spores may appear about the fourth week: in the end there is a very slight liquefaction of the medium.

On agar.—After incubating for 2 days at 37° C. a white film is seen along the line of sowing: little by little the growth acquires a green tint which gradually deepens in colour. (Agar made with Raulin's liquid is the best.)

Grijns recommends the following medium:

| | | | | | | | |
|------------------|---|---|---|---|---|------|--------|
| Water, | - | - | - | - | - | 100 | c.c. |
| Extract of malt, | - | - | - | - | - | 1 | gram. |
| Saccharose, | - | - | - | - | - | 2 | grams. |
| Agar, | - | - | - | - | - | 1.75 | grams. |

On this medium *asci* are formed.

On potato.—An abundant growth rapidly appears along the line of sowing which afterwards becomes blackish-green in colour.

3. Detection and isolation of the fungus. A. Sputum.—In suspected cases of Aspergillosis the sputum should be examined for the parasite both by microscopical examination and by cultures.

Microscopical examination.—Rénon recommends the following method: Prepare films with the green-coloured part of the sputum and stain for 10 minutes in an aqueous solution of safranin. The mycelium and spores are stained pale orange. Carbol-thionin may also be used.

Cultures.—Pick up some small fragments from the centre of the sputum and sow in tubes of Raulin's medium. Incubate at 37° C. and after 2 days the mycelium will have formed a whitish, velvety layer on the surface of the medium, and this soon becomes covered with green spores. On inoculating an emulsion of these spores into the veins of a rabbit or pigeon a fatal pseudo-tuberculous aspergillosis is set up in a few days, and if a small piece of the kidney of the experimental animal be sown in Raulin's fluid a pure culture of the fungus can be obtained.

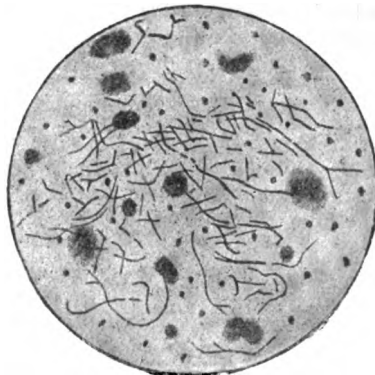

FIG. 332.—Mycelium of *Aspergillus fumigatus* in the sputum of a hair-comber. (After Rénon.)

B. Sections.—Harden the tissue in alcohol, embed in paraffin and stain either by Gram's method or by the following modification of Weigert's method.

1. Stain with Orth's picro-carmin.
2. Stain for 20 minutes in carbol-gentian-violet.
3. Wash rapidly in 0.7 per cent. normal saline solution and blot with a piece of filter paper.
4. Treat for 1 minute with Gram's solution and soak up the excess with filter paper.
5. Transfer for a few moments to aniline oil.
6. Replace the oil with xylol, blot up the excess of fluid. Mount in balsam. One or other of the methods described on p. 694 may also be used.

4. Toxin.—According to Kotliar, *Aspergillus fumigatus* forms neither toxins nor immunizing substances in culture media. Cecci and Besta have however extracted from the spores a toxic substance of unknown composition which is unaltered by boiling and can be preserved in alcohol. In rabbits,

and especially in dogs, the toxin produces a disease characterized by tremors and twitching of the muscles and by respiratory and circulatory disturbances which is fatal in a few hours (these symptoms are comparable with those of pellagra).

Cecci and Besta treat cultures rich in spores with 90 per cent. alcohol or ether for 12 days. After evaporating the solvent a greenish-yellow substance of syrupy consistence is left from which all the toxin can be extracted with water.

Bodin and Gautier have obtained a toxin, of unknown composition, possibly identical with that of Cecci and Besta, by growing *Aspergillus fumigatus* at 30° C. in a solution of peptone containing a carbohydrate (glucose, saccharose, maltose or dextrin). Under these conditions the culture becomes toxic about the twelfth day. The toxin is very resistant to heat and is only destroyed after heating at 120° C. for half an hour. When inoculated into rabbits, dogs, guinea-pigs, cats, or mice it leads to tetanic and paralytic convulsions, and if the dose inoculated be sufficient may cause death in a few hours. It should be noted that while the dog is immune to an inoculation of spores it is highly susceptible to the action of the toxin; and on the other hand the pigeon, while very susceptible to the inoculation of spores, is unaffected by six times the dose of toxin fatal to a rabbit.

5 *Aspergillus pictor*.

[Syn.—*Tricophyton pictor*.]

Pinta (Fr. *Caratés*) is the word used to describe certain chronic skin diseases, very common in Central America, characterized in their early stages by a varied pigmentation of the skin. Four varieties are recognized, the black, the blue, the violet and the red.

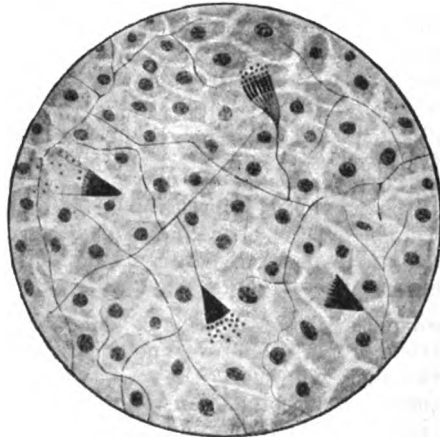

FIG. 333.—Scale from the epidermis of a case of the violet variety of Pinta. x 450. (After Montoya y Florez.)

[Ætiologically the several forms of Pinta would appear to be due each to a different species of fungus, the parasites differing from one another in the character of their fructifications. In the red and blue varieties, for instance, the fructification is similar to that of an *Aspergillus* (*A. pictor* Blanchard) in the black variety to that of a *Penicillium* (provisy. *P. pictor* Neveu-Lemaire). In other cases it is of an intermediate type (Brumpt).]

In man the parasite forms long, dichotomously-branched mycelial filaments between the epithelial cells. Some of the branches end in a pear-shaped

fructification surmounted by a single row of 5 to 6 sterigmata each carrying a row of 3 to 15 spores.

[According to Guiart, it cannot yet be considered as proved that the fungi which were described by Montoya y Florez, are the true parasites of Pinta; Darrier and Bodin have found a Tricophyton in more than one case of Pinta in Paris.]

For purposes of microscopical examination, treat the scales with warm 40 per cent. potash (p. 690). To prepare stained preparations, treat with ether to remove the fat, then with absolute alcohol containing acetic acid for 5 minutes, wash in absolute alcohol, stain in a dilute solution of Unna's polychrome blue (10 minutes) or thionin (12–24 hours), wash in absolute alcohol again, then in xylol and mount in balsam.

These fungi grow readily on glycerin-agar, beer-wort-agar, Raulin's medium, potato, etc. [Guiart has been able to cultivate the different varieties on glycerin media and on media containing iron, copper or zinc sulphate.] Cultures should be sown as described on p. 694. The optimum temperature of growth is from 25°–35° C.

The disease has been reproduced in man by Uribe. Rabbits are also susceptible. [Guiart also has produced lesions typical of the natural disease by inoculating his cultures into man and the lower animals.]

The fungi of Pinta have been found in the water of certain gold mines, the bodies of insects, etc.

[The disease is not contagious and is said to be possibly conveyed by the bites of bugs and by mosquitos of the genus *Simulium*.]

SECTION II.—THE GENUS STERYGMATOCYSTIS.

The genus *Sterygmatozystis* is characterized by spore-bearing hyphæ terminating in a spherical enlargement covered with *primary sterigmata* (fig. 334, A) which divide and give origin to several *secondary sterigmata* carrying chaplets of *conidia* (fig. 334, B and C).

1. *Sterygmatozystis nidulans*.

Syn.—*Aspergillus nidulans*.

Siebenmann attributed two cases of otomycosis to this fungus. It is pathogenic to animals (Eidam, Pinoy) and grows at all temperatures between 15°–38° C. On culture media it forms a chrome-green layer: the enlargements of the conidia-bearing hyphæ are triangular with rounded edges. The conidia measure about 3 μ in diameter. This parasite is the infecting agent in some cases of mycetoma (p. 665).

2. *Sterygmatozystis nigra*.

Syn.—*Aspergillus niger*.

This fungus is frequently found in the form of black spots on decomposing organic matter. Although it has been found several times in cases of otitis and various other diseases of man and animals it does not seem to be pathogenic. It does not grow at temperatures above 25° C. The conidial swellings have primary and secondary *sterigmata* carrying rows of black conidia measuring about 4 μ in diameter (fig. 334).

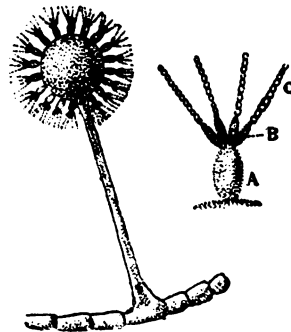

FIG. 334.—*Sterygmatozystis nigra*.

SECTION III.—THE GENUS *PENICILLUM*.

Fungi of the genus *Penicillium* possess septate conidial hyphæ dividing into verticillate or whorled branches, each carrying a cluster of spherical conidia ending at the same height and having the appearance of an hair pencil.

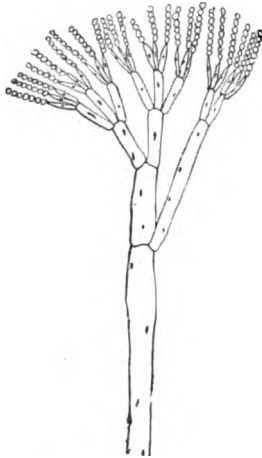

FIG. 335.—*Penicillium glaucum*.
(After Schenck.)

1. *Penicillium glaucum* (vel *crustaceum*) is one of the commonest moulds: it forms green spots when grown on bread and potato, and is used in the manufacture of Roquefort cheese. In two cases of chronic middle-ear disease, Maggiora and Gradenigo found this fungus in the Eustachian tube mixed with various other organisms. It is pathogenic for dogs, rabbits and lambs.

2. *P. minimum*, a related species, has been found in a case of acute otitis (Siebenmann).

SECTION IV.—THE PARASITE OF *TINEA IMBRICATA*.

Syn.—*Aspergillus lepidophyton* Wehmer. [*Aspergillus concentricus* R. Blanchard.] *Lepidophyton concentricum* Tribondeau.

Tinea imbricata, or Tokelau, is a disease of the skin especially prevalent in Oceania and characterized by large epidermal scales arranged in closely set concentric rings.

Tinea imbricata is said to be caused by a fungus belonging either to the genus *Aspergillus* (Wehmer) or to a very closely related genus, *Lepidophyton* (Tribondeau).

[The relationship of Tribondeau's parasite to *tinea imbricata* is not yet established. It is quite possible that this is an harmless saprophyte and that the true parasite of the disease is a *Tricophyton*—*T. concentricum* Blanchard—(Brumpt).]

The parasite is found in considerable amount in the epidermal scales in which it forms septate and branched mycelial filaments not unlike the filaments of certain of the "resistant" *Tricophyta*. Some of the filaments consist of a series of segments in the form of grains of oats, which occasionally show organs of reproduction ending in club-shaped swellings with short chains of spores.

To prepare microscopical preparations treat the scales with alcohol-ether to remove the fatty substances, then with a 4 per cent. solution of potash for two minutes, wash in water and mount in glycerin. To stain permanent preparations, treat the scales after washing in water with absolute alcohol tinted with eosin, clear in clove oil, wash in xylol and mount in balsam.

[Tribondeau has grown the parasite in pure culture on cocoa-nut and on banana and has reproduced the disease on himself (*vide T. concentricum*, p. 687).]

CHAPTER LII.
PARASITES OF THE FAMILY SACCHARO-
MYCETIDÆ.

Introduction.

Section I.—The genus *Endomyces*, p. 702.

Endomyces albicans, p. 702.

Section II.—The genus *Saccharomyces*, p. 704.

1. *Saccharomyces tumefaciens*, p. 704. 2. Other species of *Saccharomyces*, p. 705.

Section III.—The genus *Cryptococcus*, p. 706.

Section IV.—The *Saccharomycetidæ* and Cancer, p. 707.

THE *Saccharomycetidæ*, or yeasts, are unicellular fungi which multiply by budding and in which naked asci are formed freely on the mycelium. Numerous pathogenic yeasts have been described, the chief of which will now be shortly dealt with.

These parasites are sometimes described as *Blastomycetes*.¹

Among the *Blastomycetes* and with the true yeasts Guiart includes the family of the *Oididæ*, in which reproduction takes place as in the yeasts by budding and by asci, but which may show at one and the same time both a filamentous structure and a yeast-like form. This family, however, includes a number of quite dissimilar species (Chap. XLVIII.).

Methods.—The details of technique for the preparation of microscopical preparations, and of inoculation, will be described under each species. The *Saccharomycetidæ* grow on most of the ordinary neutral or slightly acid laboratory media, and on vegetable decoctions, glycerin-broth, and Nægeli's medium (p. 39) containing 2 per cent. of glucose. These media solidified with gelatin or agar, as well as glycerin-agar, potato, carrot, etc. are all well suited to their growth.

[¹ De Beurmann and Gougerot propose the abolition of the word *Blastomycetes* as a generic term on the ground that it is applied so loosely that one is never sure of its precise significance in any given context. They hold that the use of the word should be strictly limited by its etymology (*βλάστη* and *μύκης*, budding fungus), and in that sense it refers, as do the words *bacillus*, *coccus*, *filament*, etc., merely to a morphological appearance, and can lay no claim to a generic grouping.

[These observers classify the parasites dealt with in this chapter in a family, *Exoascidæ*, which they divide into three genera:—*Saccharomyces*, *Zymonema* and *Endomyces*—to which they provisionally add a fourth, *Cryptococcus*, to include various other similar but imperfectly known parasites until such time as further investigations shall have shown to which of the other genera they properly belong.]

SECTION I.—THE GENUS *ENDOMYCES*.*Endomyces albicans* (Vuillemin).

Synonyms.—*Saccharomyces albicans* Audry; *Oidium albicans* Robin; *Syringospora robini* Quinquaud.

The parasite of thrush was discovered by Ch. Robin who gave to it the name *Oidium albicans*. Audry examined the organism and classified it with the yeasts. Guiart relying on the fact that both filaments and yeast-forms can be seen places it among the Oididæ. [Vuillemin, however, demonstrated the formation of true spores within the filaments.]

Endomyces albicans is present in the air and is constantly passing into the respiratory passages, but is only able to live on the mucous membrane of the mouth when the salivary secretion is altered by some pre-existing disease. Thrush may infect the mucous membrane of the œsophagus and stomach, and occasionally also the mucous lining of the anus and vulva. Under certain exceptional conditions the parasite enters the blood-stream and causes a generalized infection (Virchow, etc.). Cases of thrush have been reported in colts and calves and also, but rarely, in birds (Eberth, Martin).

1. Experimental inoculation.—*Endomyces albicans* produces merely a local lesion when inoculated into the anterior chamber of the eye, into the peritoneal cavity, or beneath the skin of a rabbit. Inoculation of a pure culture of the fungus into the ear-vein of a rabbit may lead to a generalized mycosis with metastases in the internal organs, and may terminate fatally.

In guinea-pigs, intra-peritoneal inoculation produces peritonitis with the formation of false membranes. Intra-pleural inoculation is followed by an effusion of fluid into the pleural cavity and the parasite may subsequently become generalized.

2. Morphology. Microscopical appearance. **1. In the tissues.**—To demonstrate the parasite in cases of thrush, remove a portion of one of the characteristic whitish curdlike patches seen in the mouth, break it up in a little water on a slide, treat for a few seconds with a strong solution of Gram's liquid (p. 209) and cover with a cover-glass: when the preparation is examined under the microscope the yeasts will be seen stained brown by the iodine. The material may instead be broken up in a drop of acetic acid which clears the epithelial cells and renders the parasite more readily visible. Dried films should be stained with an aqueous solution of a basic aniline dye, which will stain the protoplasm of the parasitic cells.

The white spots of thrush consist of the parasite mixed with epithelial cells. The *Endomyces* has the appearance of long tubular septate and entangled filaments mixed up with ovoid or rounded corpuscles having a large nucleolus (the *mycelium* and *spores* of older writers).

2. In cultures.—The appearance of *Endomyces albicans* depends upon the nature of the medium on which it is growing, being absolutely different on different media. [Generally speaking, it may be stated that the more solid the medium on which it is grown, the greater the tendency to spore formation: the more liquid the medium, the greater the tendency to the formation of filaments (Wills).] In broth cultures, forms similar to those just described are found, namely long entangled filaments mixed up with numerous oval cells.—In wine, long filaments alone are seen, no oval cells.—In cultures on solid media only oval round or irregular cells occur, arranged singly or in irregular groups, each cell being surrounded by a refractile membrane which does not take the basic dyes: some of the cells will be seen to be actively budding.—In Nægeli's medium the growth assumes peculiar characters: microscopical examination shows rows or chains of oval cells on the ends of

which large spherical forms—*chlamydospores*—appear (fig. 328). These are not true spores but resistant forms, which sown on a suitable medium may bud and give rise to new filaments.

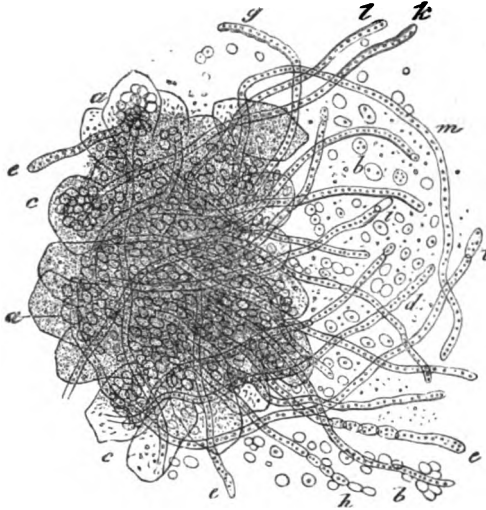

FIG. 336.—Thrush from the mouth. a, epithelial cells: b, rounded corpuscles: d, g, l, k, mycelial filaments. (Ch. Robin.)

To study the chlamydospores, the *Endomyces* must be examined in a drop of culture medium or glycerin—water would cause them to rupture.

The true reproductive organs are the asci which measure about 4μ in diameter and contain four ascospores. The development of the latter has not been followed, but they are found in the mouth, and in cultures on carrots.

2. Cultural characteristics. Conditions of growth.—*Endomyces albicans* grows at all temperatures between 28° and 39° C. and on most media. It is strictly aerobic and grows well on slightly acid, neutral, or moderately alkaline media: marked alkalinity hinders growth and interferes with the formation of the mycelium.

Cultures can be obtained by removing a little of the material from one of the lesions and, after blotting it between sterile blotting paper, rubbing it over a gelatin plate. It is better however to dilute the material in a little sterile water and to use a drop or two of the emulsion for isolating the organism on gelatin plates.

Endomyces albicans cannot be grown in saliva (Roux and Linossier). This fact explains why thrush occurs chiefly in the first two months of life—at a time that is when the salivary secretion is not yet established—and during the course of diseases which are accompanied by a diminution of the secretion.

Culture media. Gelatin.—The appearance of the colonies on gelatin is characteristic. The growth is rapid, and a number of very white, spherical,

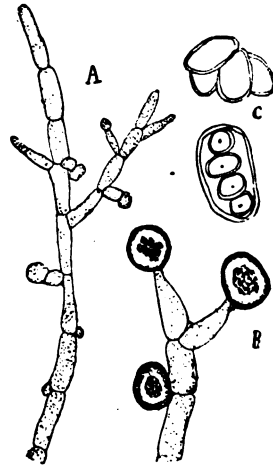

FIG. 337.—*Endomyces albicans*. A, filaments from a patch of thrush: B, terminal chlamydospores: C, asci and ascospores. (After Vuillemin.)

pearly colonies appear which however never attain any large size. The medium is not liquefied.

Agar.—At 37° C. on agar there is a rapid growth of white smooth spreading colonies.

Potato.—Small raised colonies, dirty white in colour and occasionally spotted with black.

Carrot.—On slices of carrot, the fungus forms an abundant shiny white growth in 48 hours.

Broth, sterile wine, and Neegeli's medium.—Small white masses, the liquid itself remaining clear.

3. Biological properties.—The virulence of the organism in cultures is very variable: it is attenuated by growth on artificial media and is increased by passage through animals (Roger and Grasset).

Cultures contain toxins (Charrin and Ostrowsky) but no immunizing substances. Rabbits can be immunized by inoculating them sub-cutaneously with increasing doses of attenuated living cultures or by intra-venous inoculation of increasing doses of such cultures. The serum of immunized animals exhibits agglutinating properties (Roger).

SECTION II.—THE GENUS *SACCHAROMYCES*.

1. *Saccharomyces tumefaciens* (Curtis).

Curtis isolated a parasite, to which he gave this name, from a case of myxomatous tumour of the thigh in a man.

1. Experimental inoculation.—Mice, rats and dogs are all susceptible to infection.

Following the sub-cutaneous inoculation of a small number of the parasites into rats or mice a tumour similar to that occurring in man is formed. The tumour attains enormous dimensions and the animal may die after a considerable time, but the fungus never passes into the blood-stream. Occasionally, neoplasms form in all the internal organs which appear as though sprinkled with small white dots. In the tumours the parasite is always found in pure culture.

In rabbits, intra-venous inoculation has negative results, while sub-cutaneous inoculation produces a small abscess which undergoes spontaneous resolution.

Guinea-pigs are practically immune. It is, however, possible to infect them by using a strain the virulence of which has been raised by growing it in collodion sacs in the peritoneal cavities of guinea-pigs (Wlaef). The inoculation of such cultures beneath the skin produces lesions in the skin, and occasionally a generalized infection.

2. Microscopical appearance.—In the tissues *S. tumefaciens* is encapsulated, but in cultures the capsule is generally absent.

(a) On agar at 37° C. after incubating for 48 hours growth consists of round or ovoid cells from 3–6 μ in diameter, surrounded by a double-walled membrane and containing one or

two refractile granules: in young cultures the ovoid cells are more numerous than the spherical cells and nearly all of them have a small bud at one end. Methyl violet 6B stains the centres of these cells deep violet and the wall

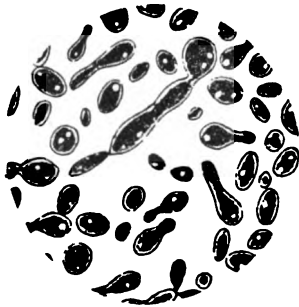

FIG. 338.—*Saccharomyces tumefaciens*. Culture on agar. (After Curtis.)

red-violet: the refractile granules are unstained. The fungus stains by Gram's method.

(b) In human and animal tissues, the parasite is much larger and occurs as spheres 16–20 μ in diameter each with a wall about 0.5 μ thick and surrounded by an hyaline capsule from 8–10 μ thick: ovoid forms and cells in an active stage of budding are also seen. The bud separates and the mother and daughter cells are then contained within the same capsule: the young buds are filled with grains of chromatin.

Sections.—For sections, Curtis recommends the following technique:—

1. Stain for a few minutes in Orth's carmine.
2. Stain for 10 minutes in the following solution:

| | |
|---|--------|
| Saturated solution of methyl-violet 6B in absolute alcohol, | 1 c.c. |
| 1 in 10,000 aqueous solution of caustic potash, | 9 c.c. |

3. Decolourize for 1 minute in a pyrogallol solution:

| | |
|------------------|----------|
| Pyrogallol, | 1 gram. |
| Distilled water, | 100 c.c. |

4. Dehydrate. Mount in balsam.

3. Cultural characteristics.—*S. tumefaciens* is an aerobic organism. Growth takes place at ordinary temperatures but is best at 37° C. and on neutral or slightly acid media.

Agar.—When the culture is sown with material from an animal tissue, white opaque punctiform colonies appear after 2 or 3 days which ultimately coalesce but never form an uniform streak. After sub-cultivating several times on agar, growth is more rapid and more abundant, and a shiny thick creamy growth is obtained from which sub-cultures can be sown as long as 6 months afterwards.

Gelatin.—Along the line of the stab, a small white discontinuous track of growth appears composed of punctiform colonies which are more numerous near the surface. The medium is never liquefied.

Broth.—The growth is very poor and consists of small white flocculi which fall to the bottom of the tube leaving the medium quite clear.

Beer-wort.—The growth is more copious than on broth which is also the case with all media which are acid to the extent of 0.3–0.5 of sulphuric acid per litre.

Potato.—At 37° C. in 48 hours a white dry-looking streak appears which subsequently becomes brown. Growth is more abundant on glycerin-potato.

On serum.—No growth.

2. Other species of saccharomyces.

(a) **Saccharomyces anginae.**—Achalme and Troisier have recorded a case of sore throat clinically resembling thrush, but due to a yeast consisting of ovoid globules showing more or less large buds.

S. anginae grows easily on ordinary media. On solid media the growth is thick copious and pinkish-grey in colour. Microscopical examination of cultures shows forms identical with those found in the tissues, and occasionally [in cultures grown on alkaline peptone gelatin] asci each containing four ascospores.

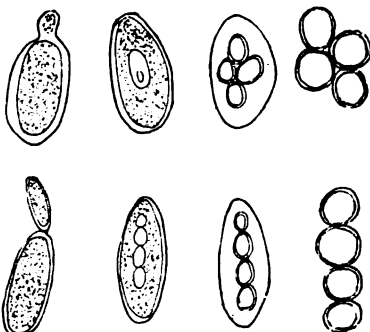

FIG. 339.—*Saccharomyces anginae*. (After Troisier and Achalme.)

Similar fungi have been described under the following conditions.

(β) *Saccharomyces granulatus* in a tumour of the human jaw (Vuillemin and Legrain).

[(γ) *Atelosaccharomyces*¹ *busse-buschki*, de Beurmann and Gougerot] (*Cryptococcus hominis*, Vuillemin) found in a case of osteo-myelitis of the tibia and giving rise to a generalized infection (Busse).

(δ) *Saccharomyces ellipsoideus* [vel *roseus*] found in cases of middle ear disease by Maggiora and Gradenigo.

(ε) *Saccharomyces membranogenes* isolated by Steinhaus from the false membrane on the trachea in a case of diphtheria.

(ζ) *Saccharomyces guttulatus* in the intestine of the rabbit (Robin, Casagrandi and Buscalioni).

SECTION III.—THE GENUS CRYPTOCOCCUS.

Vuillemin classifies together in a provisional genus—*Cryptococcus*—certain *Blastomyces* in which the formation of asci has never been observed.

1. *Cryptococcus dermatitis* (Gilchrist and Stokes).

[*Syn.*—*Zymonema*² *gilchristi*, de Beurmann and Gougerot : *Cryptococcus gilchristi*, Vuillemin : *Blastomyces dermatitis*, Gilchrist and Stokes.

[This parasite is the cause of a very chronic dermatitis known in America as oidiomycosis, dermatitis coccidioides, protozoic dermatitis, blastomycetic dermatitis, psorospermiasis, blastomycosis, coccidioidal granuloma and saccharomycosis (I. H. Wright). The disease is apparently not uncommon in America though rarely seen in Europe.

[*Microscopical appearance.*—In the tissues the micro-organism generally occurs as spherical cells surrounded by a thick membrane; as a rule the cells are seen in pairs of unequal size the smaller having been budded off from the larger.

[*In cultures.*—Cells similar to those seen in the lesions are found, in addition to short mycelial filaments.

[The parasite does not appear to be pathogenic when inoculated beneath the skin of mice, guinea-pigs and dogs.]

2. *Cryptococcus (Saccharomyces) lithogenes* was found by Sanfelice in the glands of a bovine animal suffering from carcinoma of the liver. The yeast consists of spherical bodies of variable size, enclosed within a refractile membrane, and often undergoing calcareous degeneration in the tissues. It grows easily on ordinary culture media and is pathogenic for guinea-pigs, sheep and mice. In guinea-pigs, it leads to a generalized infection characterized by the formation of nodular swellings containing calcareous concretions.

3. *Cryptococcus linguae pilosae* was described by Lucet as occurring in several cases of black tongue: it grows best on glucose media and is pathogenic for mice, but Lucet failed to reproduce the lesions of black tongue experimentally. In one case Gueguen found an *Oospora (Oospora lingualis)* in association with the *cryptococcus*.

4. *Cryptococcus farcinosus* is the cause of epizootic lymphangitis, a contagious disease affecting horses, mules [and cattle] (Rivolta). [The disease is indigenous along the Mediterranean littoral particularly in Italy, and has been imported into India, South Africa and England probably with infected mules.] This yeast, consisting of oval or rounded cells often budding at one end, grows with difficulty except on potato or coagulated glycerin-glucose-horse-serum.

[¹ ἀτελής, imperfect.]

[² ζύμη yeast, νήμα filament.]

5. *Cryptococcus tokishigei*.—The disease known as “Japan farcy” is caused by a similar parasite,—*Cryptococcus tokishigei* (Tokishiga).

6. *Cryptococcus degenerans*, isolated by Roncali from several cases of malignant growths, etc.

SECTION IV.—THE SACCHAROMYCES AND CANCER.

By inoculating a guinea-pig under the skin with a species of *Saccharomyces* (*S. neoformans*) which he found in the juice of fermented fruits, Sanfelice produced a myxomatous tumour at the site of inoculation which killed the animal within a month.

This observation, coupled with his discovery of the *Cryptococcus* (*Saccharomyces*) *lithogenes* (*vide ante*) in the glands of an ox suffering from carcinoma of the liver, gave a certain amount of impetus to a theory previously advanced by Russell that malignant new growths are the result of an infection with blastomycetic fungi.

The theory is however now discarded. In the first place, it is very difficult to explain the intra-cellular position of a yeast in an epithelial cell (Borrel); secondly, it would seem to be proved that a culture of a yeast has never been obtained by sowing a non-ulcerated malignant growth (Curtis); thirdly, the inoculation of blastomycetic fungi into the lower animals has never given rise to growths histologically comparable to sarcomata or carcinomata; and finally the serum of persons suffering from malignant growths is totally devoid of agglutinating properties for the yeasts found in tumours by Sanfelice, Curtis and others (Brouha).

[A. S. Grünbaum fed several mice on a yeast isolated from a mammary cancer. The majority of the animals were unaffected but two which died 43 and 46 days respectively after being fed showed nodules in the lungs, bronchial glands and intestines. While the cell proliferation observed in these nodules appeared to be quite distinct from that seen in ordinary inflammation it is not suggested that anything in the nature of a neoplasm was produced. “So far as these experiments go they neither support nor weaken any parasitic hypothesis concerning the ætiology of new growths, which hypothesis indeed, if no specific parasite be assigned as the cause, is not an unreasonable or an unlikely supposition.”]

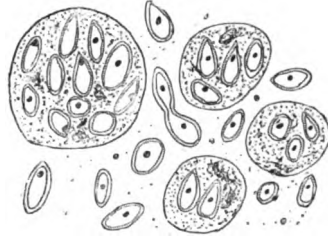

FIG. 340.—*Cryptococcus tokishigei*, in the pus of an abscess, with phagocytosis. (After Tokishiga.)

PART IV.

THE PATHOGENIC SPIROCHÆTÆ.

CHAPTER LIII.

THE BLOOD-INHABITING SPIROCHÆTES.¹

A. Human spirochaetosis.

Introduction.

Section I.—Experimental inoculation, p. 713.

Section II.—Morphology and methods of detection, p. 714.

1. Microscopical appearance and staining reactions, p. 714. 2. Cultivation of the parasites, p. 715.

Section III.—Serum therapy, p. 716.

The differentiation of the various human spirochætes, p. 717.

B. Spirochaetosis in the lower animals.

1. *Spirochæta anserina*, p. 717. 2. *Spirochæta marchouxi*, p. 718. 3. *Spirochæta theileri*, p. 719.

A. HUMAN SPIROCHÆTOSIS.

It is a matter of historical interest that the parasite of human relapsing fever, a spirochæte discovered by Obermeyer in 1868, was the first micro-organism to be found in a strictly human disease.

Under natural conditions relapsing fever only affects man. The parasite is present in the blood during the attacks of fever but can only be found occasionally and in small numbers during the apyrexial intervals: about the time of the crisis the spirochætes generally disappear from the blood of the peripheral circulation and can then only be found in the spleen where they are taken up by the leucocytes. The disease can be readily reproduced in man by the inoculation of blood containing the parasites. The spirochæte has been found to remain alive for more than a month in the intestines of leeches which have been fed upon infected blood, and the disease seems to be transmitted naturally by certain blood-sucking insects.

Relapsing fever was first observed in certain parts of Europe: Russia, Turkey, Northern Germany. The disease is most common among the dirtier members of the population and in Europe bugs (*Acanthia lectularia*) and lice (*Pediculus corporis*) would seem to be the agents of transmission.

[Nicolle, Blaizot and Conseille have shown that in Algeria relapsing fever is transmitted by lice (*Pediculus vestimenti* and *P. capitis*). The bite of the insect is innocuous and infection takes place by the "contaminative" method, the spirochætes being rubbed into the wound caused by the bite of the insect by the scratching induced as the result of the bite. The method of infection

¹ The Spirochætes were formerly grouped with the Vibrios among the Bacteria but since Schaudinn's investigations they have been regarded as Protozoa and have been classified with the Trypanosomata (Flagellata). The point is however still *sub judice*. Caullery and Mesnil, Doflein and also Borrel consider that these parasites occupy an intermediate position between the Bacteria and the Protozoa.

therefore is the same as was shown by Leishman and by Hindle to obtain in the case of *S. duttoni* and *Ornithodoros moubata*. These observers have also been able to demonstrate that hereditary infection occurs in the body louse, an important fact which proves that this insect is a true intermediate host for the spirochæte. Attempts to transmit the spirochæte to monkeys by means of the tick *Ornithodoros savignyi* obtained in Tripoli completely failed. In one experiment Nuttall demonstrated that *A. lectularia* fed on an infected mouse and immediately afterwards upon a healthy mouse transmitted *S. recurrentis* from the former to the latter.]

Relapsing fever also occurs in Asia—India, Persia, China and other parts—and in that continent the disease is apparently propagated either by the parasites mentioned above or, as in Persia, by a tick—the bug of Mianeh,—*Argas persicus*.

In [West and] East Africa relapsing fever is known as *Tick fever*. Lafforgue has described a similar disease in Tunis. Tick fever differs somewhat from the European disease chiefly in being much more fatal and in the fact that the fever is of shorter duration and the spirochætes are less numerous in the blood of the peripheral circulation. The African fevers are conveyed by a tick (*Ornithodoros moubata*) which only bites at night. This disease was described by Dutton and Todd, Kudicke, Koch and others.

[In the case of *S. duttoni* the tick produces infection only as a result of the entrance of the infective excreta into the wound produced by the bite of the insect (Leishman, Hindle).]

In the tick the spirochæte multiplies on the surface of the ovary and passes into the egg and young embryo.

[Leishman found that *S. duttoni* breaks up into minute masses of chromatin—"coccoid granules"—in the ova and tissue-cells of the tick *Ornithodoros moubata* and it would appear that these coccoid granules again develop into spirochætes.

[Möllers has shewn that ticks may remain infective for as long as 1½ years after their initial feed upon an infected animal. "Möllers has, moreover established the fact that infected ticks fed on six successive clean animals may, following upon each feed of blood, lay six successive batches of infected eggs, from which issue young ticks capable of transmitting the spirochæte to experimental animals. Even more remarkable is the fact that the ticks may remain infective to the third generation the ticks throughout the second generation having been fed upon clean animals." 1]

Relapsing fever also occurs in America and especially in the United States.

At the present time opinion is in favour of regarding the spirochætes found in relapsing fever in different parts of the world as belonging to different species (Novy and Knapp, [Nuttall], Fränkel and others) of which the following are distinguished.

Spirochæta recurrentis (= *obermeyer*), the spirochæte of European relapsing fever.

Spirochæta duttoni, the spirochæte of [West] African relapsing fever (Tick fever).

Spirochæta novyi, of American fever.

Spirochæta carteri, of Indian fever, which however seems to be very closely related to *S. recurrentis*.

[*Spirochæta rossii* (*S. kochi*), the parasite of East African relapsing fever.]

For the present the various spirochætes are differentiated by biological tests; the differences in morphology and in the diseases produced by experimental inoculation being in many cases very slight.

[1 Nuttall, *Harben Lectures* 1908.]

SECTION I.—EXPERIMENTAL INOCULATION.

I. **European relapsing fever** can be transmitted from man to man by inoculation (Münch, Metchnikoff, etc.).

Carter and Koch have further shown that the apes of the old world can be infected by inoculating them beneath the skin with the blood of an infected man. The relapses which are so characteristic of the human disease are not always reproduced in inoculated apes.

The phenomena following the inoculation of spirochætes into monkeys have been investigated by Metchnikoff and by Soudakewitch. The Cercopithecæ are particularly susceptible to inoculation.

During the febrile attack the spirochætes are very numerous in the fluid part of the blood. At the time of the crisis they disappear from the peripheral circulation but are present in enormous numbers in the spleen where during the apyrexial interval they are contained within the leucocytes, and masses of leucocytes containing spirochætes can be found forming small microscopic abscesses. A single leucocyte may contain several spirochætes and occasionally accumulations of spirochætes arranged like the spokes of a wheel can be observed around some of the leucocytes. The parasites soon disappear from the interior of the leucocytes leaving only irregular-shaped granules and a little later the leucocytes resume their normal appearance. Some of the phagocytes however have succumbed in the attack as can be shown by the fact that their nuclei are destroyed and will not take up staining reagents. The spirochætes are taken up by the leucocytes while the former are living so that if a little material from the spleen of an animal killed during the apyrexial interval, when all the parasites are intra-cellular, be inoculated into a normal animal the latter will become infected; from which it is obvious that some of the Spirochætes retain their virulence even after being phagocyted, and it is these which in some way not yet understood are responsible for the relapses occurring in the human disease (Metchnikoff, Bardach).

Some experiments of Soudakewitch are important as showing the rôle of the spleen in relapsing fever. The spleens of a number of monkeys were removed and the animals afterwards inoculated with infected material with the result that all the animals died, phagocytosis was absent and the numbers of the spirochætes went on increasing until finally they exceeded in number the red cells of the blood.

Mice and white rats can be infected by the inoculation of blood containing the *Spirochæta recurrentis*. After intra-peritoneal inoculation the mouse suffers from a typical attack of the disease with two or three relapses and ultimately recovers. The rat does not as a rule suffer from relapses—though sometimes a single somewhat delayed relapse may be observed (Breinl and Kinghorn)—and has recovered its normal health in about 40 hours. Fülleborn and Mayer, Uhlenhuth and Händel have not been able to infect mice and rats with human blood but only with blood from an infected Cercopithecus.

Rabbits and guinea-pigs are almost immune.

II. **West African relapsing fever (Tick fever)**. The spirochæte of West African relapsing fever, *S. duttoni*, is generally speaking more virulent for the lower animals than is *Spirochæta recurrentis* (Breinl and Kinghorn). The Cercopithecæ and Macacus monkeys are very susceptible. Mice and rats often die after being inoculated intra-peritoneally with infected human blood; they suffer from a number of successive attacks, usually less and less severe, over a period which varies from 3–45 days. The chief lesion is an hypertrophy of the spleen with hæmorrhages into the organ.

Rabbits also suffer from a severe attack of the fever if inoculated intra-peritoneally with a large dose (5 c.c. or more) of infected blood.

Guinea-pigs seem to be more highly immune than rabbits.

Experimental inoculation with filtered blood.—Novy and Knapp found that porcelain-filtered blood from rats infected with *S. recurrentis* in which on

microscopical examination no spirochætes could be found was infective for rats.

The blood was diluted with 10 parts of citrated normal saline solution and filtered through new Berkefeld bougies under a pressure of 50 pounds.

Repeating these experiments with *S. duttoni*, Breinl and Kinghorn once or twice produced a mild infection in rats.

SECTION II.—MORPHOLOGY AND METHODS OF DETECTION.

1. Microscopical appearance and staining reaction.

Blood should be obtained by pricking the finger. A number of blood films should be spread and dried ready for staining, and a drop of blood should also be examined in the fresh unstained condition.

The examination of fresh blood.—If a drop of blood be taken during an attack of fever and examined fresh under the microscope, numerous spirochætes will be seen lying between the red cells of the blood, 8–10 μ long, very slender and pointed at their ends, each showing six to fifteen spirals. They are highly motile and scattering the red cells as they go move in a straight line either in an oscillatory manner or with a cork-screw-like motion. The spirochætes tend to agglutinate and form rosettes in the blood of persons suffering from relapsing fever (fig. 342). Very long organisms are sometimes seen measuring perhaps 100 μ from end to end; these appearances are really due to the fact that several individuals have become attached to one another end to end.

FIG. 341.—*Spirochæta recurrentis*. Blood film. (Oc. 2, obj. $\frac{1}{4}$ th, Zeiss.)

It is said that the movements observed in spirochætes are due to flagella which stain only with difficulty, and four flagella have been described arranged in bunches of two at each end of the parasite. Zettnow using a modification of Borrel's method (*vide S. marchouxii*) has described a peritrichial structure surrounding the *S. duttoni* the flagella being inserted all over the surface of the spirochæte. Novy and Knapp have not been able to demonstrate lateral flagella but describe a long single undulating flagellum in *S. recurrentis* attached to one end of the organism: in Breinl's opinion this is merely a prolongation of the periplast. [According to Nuttall, "authors who claim that spirochætes possess flagella have been led into error by the study of stained specimens of macerated spirochætes, these having been rendered quite abnormal in appearance through the partial stripping off of their outer layer or periplast, the myonemes forming the pseudo-flagella.]

The spirochætes never form spores : reproduction takes place according to some observers by transverse division (Metchnikoff, Bardach) and according to others by longitudinal division (Schaudinn, [Nuttall]).

Spirochætes can be kept alive for several days in hanging drop preparations but the addition of normal saline solution destroys their motility and causes them to agglutinate in a few minutes (Karlinski).

If the blood be collected as soon as they begin to appear in it the spirochætes can be kept alive for 40 days but if collected just before the crisis when they are about to vanish from the circulation they die in a day or two (Novy and Knapp).

Staining reactions.—The *S. recurrentis* is somewhat difficult to stain and special methods have to be adopted. It is gram-negative.

1. Blood-films.—Blood-films should be dried in the air or in an oven at 60°–70° C. but should on no account be passed through the flame. To render the parasites more conspicuous the hæmoglobin may be dissolved out of the red cells before staining the films. The best method for staining is Günther's but any of the methods described as suitable for staining the *Treponema pallidum* may be used.

Günther's method.—Follow the instructions given on p. 206 using Ehrlich's aniline violet as the dye and leaving it to act for 8–10 minutes.

The red cells are unstained, the white cells and the parasites are stained violet.

By staining the blood-films not only are the Spirochætes more easily seen but they appear much more numerous than in fresh, unstained preparations.

2. Sections.—Pieces of the spleen should be fixed in absolute alcohol and embedded in paraffin. The sections may be stained by Nikiforoff's method.

Nikiforoff's method.—1. Stain the sections for 24–48 hours at the ordinary temperature of the laboratory in the following solution :

| | | |
|---|-------|----------|
| Saturated aqueous solution of methylene blue, | - - - | 10 c.c. |
| Distilled water, | - - - | 10 " |
| 1 per cent. alcoholic solution of tropeolin, | - - - | 1 " |
| 10 per cent. solution of potash, | - - - | 4 drops. |

2. Wash in distilled water, then in alcohol-ether.

3. Clear in clove oil and xylol and mount in balsam.

2. Cultivation of the parasites.

Most attempts to grow Spirochætes in artificial culture have failed. Norris, however, and Pappenheimer and Flourney by sowing a few drops of the blood of an infected rat in citrated human or rat blood noticed a considerable multiplication of the Spirochætes after 24 hours but the cultures could not be maintained further than the second generation.

Levaditi sowed *S. duttoni* in macacus serum previously heated to 70° C. and placed the culture in collodion sacs in the peritoneal cavities of rabbits ; in this way he obtained luxuriant cultures of the organism. Adopting Levaditi's technique but using non-coagulated rat blood in the sacs in the early cultures Novy was able to grow an Indian Spirochæte for twenty generations : the cultures which were always scanty were virulent for rats and retained their vitality for 7 days.

Duval and Todd seem to have been able to obtain a certain amount of growth through two generations by sowing an American Spirochæte in a complicated culture medium. A broth was made with skinned mice and sterilized : egg yolk and defibrinated mouse blood was then added and allowed to macerate in sealed vessels in the incubator at 37° C. for 6 or 8 weeks. The medium was then sown with the blood of an infected mouse.

[Noguchi has succeeded in cultivating *S. recurrentis*, *S. duttoni*, *S. rossii* and *S. novyi* in test tubes.

Noguchi's method.—The most satisfactory of the methods employed appears to be the following. Place a piece of fresh rabbit kidney in a sterile test tube, add a few drops of citrated blood from the heart of an infected mouse or rat and then about 15 c.c. of sterile ascitic or hydrocele fluid. A layer of sterile paraffin oil may be poured on the surface to prevent evaporation. Incubate at 37° C. Growth reaches its maximum about the 7th–9th day. Sub-cultures may be sown with about 0.5 c.c. of a young (4th–9th day) culture but it is well to add a small quantity of normal blood (human or rat). Noguchi has sub-cultivated *S. rossii* twenty-nine times during a period of 6 months.]

SECTION III.—SERUM THERAPY.

I. Once a man has recovered altogether from an attack of relapsing fever he is immune to further attack. It is also—as a large number of experiments have shown—beyond dispute that after recovering from an experimental infection animals are immune [to further inoculation of the same species].

II. Gabritchewsky has shown that after the fever has subsided monkey's blood is bactericidal *in vitro*.

A drop of blood containing numerous Spirochætes was collected from a patient during the febrile period and mixed with a drop of serum taken from a monkey during the apyrexial period: in from 1–4 hours the Spirochætes became non-motile, swollen “and in short altogether changed in appearance.” When on the other hand the blood was mixed with normal serum the Spirochætes remained alive for from 45–160 hours.

According to Metchnikoff, and Soudakewitch, the altered parasites seen by Gabritchewsky were merely artefacts.

The agglutination reaction with the serum of persons who have recovered or are still suffering from relapsing fever gives very irregular results.

III. By inoculating a monkey with the serum of another monkey which had passed the crisis Gabritchewsky was able to induce an early crisis (48 hours, against 72 hours followed by a relapse in a control animal).

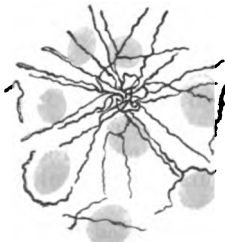

FIG. 342.—Rosette agglutination in human blood. (Günther's stain.)

Bardach inoculated a monkey—with a temperature of 39° C. and Spirochætes in its blood—with 6 c.c. of blood from another animal taken 4 hours after the crisis and found that by the next day the temperature was normal and the Spirochætes had disappeared from the peripheral circulation: the temperature remained normal for 7 days then the animal had another attack of fever and Spirochætes re-appeared in its blood. It is possible in this case that as a result of the inoculation of the serum the Spirochætes were phagocyted but not destroyed, and escaping from the leucocytes were the cause of the relapse.

IV. Novy and Knapp demonstrated that the blood of spirochæte-infected rats is both bactericidal and agglutinating.

The spirochætes are agglutinated spontaneously in blood taken during the time the temperature is falling while the blood of rats which have recovered has agglutinating properties. The spirochætes are agglutinated end to end often in long threads (p. 714) or in rosettes or sometimes in irregular masses.

The serum of rats which have recovered from an infection has slight prophylactic properties (Novy and Knapp, Carlisle, Breinl): it does not prevent infection but prolongs the incubation period. This prophylactic property is

very much more marked (250 times more so) in the blood of rats which have been hyper-immunized by the inoculation into the peritoneal cavity every other day of 0.25-1 c.c. of blood rich in spirochætes. The blood of animals treated in this way has therapeutic properties as well (Novy and Knapp).

If the serum of such hyper-immunized rats be inoculated either before or at the same time as the virus it will in quantities of 0.002 c.c. protect a rat against an inoculation of 0.1 c.c. of spirochæte-infected blood. If inoculated in quantities of 2 c.c. into rats showing Spirochætes in their blood it will cause all the parasites to vanish once and for all within an hour. In those species subject to relapses (mice, monkeys) the serum will prevent the initial attack but the subsequent relapses come on as though the animals had not been treated with the serum.

The immunity conferred by an inoculation of the serum would seem to last more than 2 months in rats, mice and monkeys.

The differentiation of the various human Spirochætes.

The different Spirochætes parasitic in the blood of man can be differentiated by means of the serum reactions. The serum of a rat hyper-immunized against a given species of Spirochæte will agglutinate that species and will cause it to undergo granular disintegration both *in vitro* and *in vivo* (cf. Pfeiffer's phenomenon): but has no action or at most a very slight action on other species (Uhlenhuth and Händel).

The method of crossed immunity does not afford such a sharp means of differentiation. There is always an active crossed immunity between *S. recurrentis* and *S. novyi*: crossed immunity is less often observed (in about 50 per cent. of cases) between *S. recurrentis* and *S. duttoni* and very seldom between *S. duttoni* and *S. novyi* (Uhlenhuth and Händel). Fränkel whose results are rather different has observed no crossed immunity between *S. rossii*, the Spirochæte found by Koch in German East Africa and *S. duttoni* of West African fever.

B. SPIROCHÆTOSIS IN THE LOWER ANIMALS.

1. Spirochæta anserina.

S. anserina, an organism similar to *S. recurrentis* was found by Sakharoff at Tiflis in a disease of geese.

Morphologically, *S. anserina* is very like *S. recurrentis* but is a little shorter, thicker and less undulating. It cannot be grown on the ordinary laboratory media.

In infected geese the Spirochætes are present in the blood for several days then they suddenly disappear and the birds die of toxæmia after surviving the infection. *Post mortem* the internal organs will be found to have undergone fatty degeneration.

The experimental disease has been carefully studied by Cantacuzène. Geese, ducks, young chickens, sparrows, and pigeons are all highly susceptible: adult fowls and rodents are immune.

To demonstrate the spirochæte in sections of the tissues Cantacuzène gives the following technique:

1. Cut the tissues into very small pieces and fix in Flemming's solution for 24 hours. Wash in water for 24 hours.

2. Embed in paraffin (xylol method).

3. Cut very thin sections, fix them on the slides and stain for 24 hours in the following solution:

| | |
|-----------------------------|----------|
| Carbol-fuchsin, | 2 parts. |
| Neutral glycerin, | 1 part. |

4. Wash rapidly in water, blot up the excess of water, dehydrate in several lots of pure ether for 4-6 hours and mount in balsam dissolved in ether.

In susceptible animals the Spirochætes multiply in the blood after inoculation and disappear from the circulation as soon as the temperature falls. The Spirochætes

never perish in the blood *in vivo*: they undergo no bacteriolytic change and are not taken up by the leucocytes. As soon as the fever passes off the Spirochætes are phagocyted by the *mononuclear* phagocytes in the spleen: when phagocyted they lose their staining capacity and are dissolved *en bloc* without undergoing any granular disintegration. The birds die after the parasites are phagocyted the defensive mechanism being unable to deal with the toxin.

2. *Spirochæta marchouxi*.

Syn.—*Spirochæta gallinæ*.

This parasite which resembles the *S. anserina* was discovered by Marchoux and Salimbeni in the blood of fowls suffering from a disease prevalent in Rio de Janeiro. The same disease has been found among fowls in Tunis, in the Soudan, in Senegal, [in India (Greig), in Cairo (Bitter), in South Australia (Johnson and Nuttall)].

Galli-Valerio considers that *S. marchouxi* and *S. anserina* are the same organism but Brumpt, Borrel and other observers from the facts of crossed immunity believe that the diseases of fowls due to infection with spirochætes are different diseases due to different though closely related parasites: so that they describe the Rio de Janeiro parasite as *S. marchouxi seu gallinarum*, the Tunis parasite as *S. nicolei* and the Senegal parasite as *S. neveruxi*.

S. marchouxi is pathogenic for fowls, geese, ducks, sparrows and turtle doves. Inoculated into rabbits it gives rise to a disease of short duration which resolves spontaneously.

The disease can be transmitted by the inoculation of infected blood and by feeding experimental animals upon the dejecta of birds suffering from the disease. Under ordinary natural conditions the disease is spread by a tick [—*Argas persicus* (and in laboratory experiments by *A. reflexus* and *Ornithodoros moubata*) Marchoux and Salimbeni, Nuttall, Balfour, Greig.] Ticks may harbour the parasites for 5 months [or more]. In the external media the Spirochætes lose their vitality in 48 hours.

Morphology.—To obtain the best preparations Borrel advises defibrinating the infected blood and then centrifuging it. The Spirochætes which will be found in the upper layers should then be washed and centrifuged several times and drops of the last washings spread on slides mordanted with tannate of iron and stained with fuchsin (p. 151).

In these preparations long flagella will be found all over the bodies of the parasites and especially at one end, the other end being as a rule non-ciliated; the short forms have only the terminal tuft of flagella. Some of the parasites seem to have a long flagellum at one or at both ends (cf. *ante*).



FIG. 343.—*Spirochæta marchouxi*.
Leishman's stain. $\times 1000$.

Multiplication takes place by transverse division. [According to Nuttall spirochætes divide by longitudinal division.]

Cultures.—Borrel and Burnet succeeded in obtaining freely growing cultures but were unable to propagate them beyond the second generation. The medium used was citrated fowl blood or serum obtained by defibrinating and centrifuging the blood. Levaditi was able to grow the spirochætes in collodion sacs in the peritoneal cavities of guinea-pigs using fowl serum as the culture medium.

[By adopting the method employed for the cultivation of the human blood-inhabiting spirochætes (p. 716) Noguchi has been able to grow *S. marchouxi* outside the body.]

Immunity.—A first attack always confers immunity. Animals may be artificially immunized by inoculating them with blood containing spirochætes after it has been kept for 2–4 days or heated to 55° C. for 10 minutes. Serum from blood recently collected from birds suffering from the disease filtered through a Berkefeld bongie has similar immunizing properties.

The serum of animals which have recovered from an attack of the disease exhibits prophylactic properties and has a marked agglutinating action on the Spirochætes *in vitro*.

3. Spirochæta theileri.

[*S. theileri* was discovered by Theiler in the blood of cattle about Pretoria.] Laveran gave the first published description of the parasite. This spirochæta measures 8–30 μ long, shows a variable number of spirals and has no flagella. Cattle infected with the spirochæte [often] show Trypanosomes or Piroplasmata in the blood in addition, and the presence of the Spirochæte is accompanied by certain changes in the blood as for example nucleated erythrocytes and erythrocytes containing basophile granules.

The disease is transmitted by a tick (Theiler). His experiments were repeated in France: A number of larvæ of *Boophilus* (*Rhipicephalus*) *decoloratus* raised from the eggs of a tick which had been fed upon an infected bovine in the Transvaal were sent by Theiler to Laveran and Vallée who placed them on a cow at the experimental farm at Alfort. The spirochætes appeared in the blood of the cow 14 days later but were only found for 4 days: 4 days later the cow developed acute Piroplasmosis (*P. bigeminum*) and died.

Spirochætosis in the horse (Theiler), and in sheep (Theiler and Ziemann) which also occur in the Transvaal are apparently due to infection with *S. theileri* (Dodd) [but their identity cannot be regarded as established (Nuttall)].

CHAPTER LIV.

TREPONEMA PALLIDUM.

Introduction.

Section I.—Experimental inoculation, p. 721.

Experiments on immunization, p. 724.

Section II.—Morphology, p. 725.

1. Microscopical appearance, p. 725. 2. Staining methods, p. 726.

Section III.—Detection and identification of the treponema, p. 732.

1. Collection of material, p. 732. 2. Methods of examination, p. 733. 3. Identification of the organism, p. 734.

Section IV.—Cultivation experiments, p. 736.

Section V.—Serum diagnosis, p. 737.

The nature of Wassermann's reaction, p. 738. Wassermann's technique, p. 739.

Chemical methods, p. 740.

THE infecting agent in syphilis is a spirochæte. Though the organism had been previously observed by Bordet and Gengou, Schaudinn and Hoffmann in 1905 were the first to describe it, and to them is due the credit of definitely identifying it with the disease.

Nomenclature.—The name given to the organism by Hoffmann was *Spirochaeta pallida*. But the spirochæte of syphilis differs so considerably from the other spirochætes (*vide infra*) as to constitute a definite genus and Vuillemin suggested the name *Spirochæta*. This name had, however, been already appropriated and was abandoned in favour of *Treponema*. *Treponema pallidum* is now accepted by all authors.

The relationship of the treponema pallidum to syphilis.—Of the specific nature of the *Treponema pallidum* there can now be no longer any doubt. Though it has been cultivated outside the body [only very recently], the pathogenic rôle of the treponema is adequately attested by the following facts: it has been found by observers in all parts of the world in the lesions of the primary and secondary stages; it is constantly present in the lesions of congenital syphilis; it is found in the blood of persons suffering from syphilis; and it is never found either in healthy persons or in persons suffering from diseases other than syphilis.

Distribution of the parasite in the tissues.—1. In man, the *Treponema pallidum* is present in the hard chancre (Hoffmann and Schaudinn, Metchnikoff and Roux and others) and can be found in practically every case: Ravaut and Le Sourd, for instance, were able to demonstrate it in 17 out of 19 cases. It is also found in the enlarged glands associated with the chancre (Hoffmann and Schaudinn and others).

2. The treponema occurs also in the lesions of secondary syphilis: it is to be found in the mucous patches and papules, psoriasis palmaris, etc. (Schaudinn and Hoffmann, Roux and Metchnikoff, and others): and in sections of the rose spots

(Veillon and Girard), but in the rash the organisms are very few in number and difficult to demonstrate.

The blood is also infective at times and in a transitory manner during the secondary period, and on inoculation into monkeys will produce syphilis in about 50 per cent. of the animals inoculated. The number of treponemata in the blood is, however, small, and this fact explains the failure of many observers to detect their presence. Nevertheless, by adopting improved methods of observation, the organism has been found in the peripheral circulation. The treponema may also be found in the fluid obtained by blistering a non-ulcerated lesion of the skin (Levaditi and Petresco).

The organism can almost never be found in the internal organs: though in one case Schaudinn and Hoffmann were able to demonstrate it in a stained specimen of material obtained by puncture of the spleen. During the secondary period the secretion of the testes is sometimes infective but the treponema has never been demonstrated in it.

3. In the lesions of tertiary syphilis the treponema is present but in small numbers only; these lesions are, however, infective. Monkeys, for instance, have been infected with fragments of gummata and with the blood of a patient in the tertiary stage (Hoffmann). Many observers have failed to find the treponema by staining material from tertiary lesions; the organism has nevertheless been found in the papules and in gummata. Reuter demonstrated the organism in the walls of the aorta of a person affected with syphilitic aortitis.

4. The treponema is found in largest numbers and in every organ of the body in congenital syphilis and in this form of the disease the blood is much more frequently infected than is the case with syphilis in the adult. Thus it has been demonstrated in the skin in pemphigus, in the bones in osteo-chondritis, and in the inguinal lymphatic glands. In the alimentary system it has been found in the mucous membrane of the cheeks and pharynx, in the tonsils, in the walls of the stomach and in the liver and gall-bladder. In the genito-urinary tract its presence has been noted in the bladder and in the ovary and it may even penetrate into the Graafian follicles (Hoffmann, Levaditi and Sauvage). It occurs in the ductless glands, spleen, suprarenal glands and thymus. It is present also in the lungs. In the nervous system it has been described in inflammatory foci in the meninges, in the brain and in the peripheral nerves.

Spirochaetes are found in the placenta only when the infant has obvious manifestations of a syphilitic infection.

5. The treponema is found in the primary and secondary lesions of experimentally infected monkeys (Roux and Metchnikoff, Neisser, Hoffmann and others). Although the internal organs (spleen, bone marrow, lymphatic glands) are infective (Neisser) the treponema has not hitherto been demonstrated in them.

[Now that Noguchi has succeeded in growing the *Treponema pallidum* in pure culture (p. 737) and has been able to produce typical syphilitic lesions in rabbits by the inoculation of his pure cultures there is evidence that at any rate the lesions produced in the rabbit by the inoculation of syphilitic material are due to the treponema and not to any adventitious organisms which may have been inoculated with it.]

SECTION I.—EXPERIMENTAL INOCULATION.

The experimental study of syphilis was for a long time very barren of results. Inoculation of man, despite its seriousness, was occasionally performed and the fundamental basis of the ætiology of the disease established. On account of the difficulties and dangers attending the inoculation of syphilitic material into man, experiments were undertaken with the object of infecting the lower animals. Experiments on the ordinary laboratory animals repeatedly failed and resort was had to monkeys, but here again, inoculation of the lower monkeys gave only inconstant and inconclusive results.

Experiments were then carried out on the anthropoid apes by Roux and

Metchnikoff, who in 1903 demonstrated that these animals were susceptible to the virus of syphilis.

I. Chimpanzee.—The chimpanzee is the most suitable animal for the purpose of studying syphilis experimentally. Compared with man this species may be regarded as equally susceptible to syphilis. Inoculation under the conditions described below is certain to result in infection (Roux and Metchnikoff).

The virus is best obtained from a chancre or secondary lesion and should be inoculated into superficial scratches made on any part of the body, but preferably on the superciliary ridges, upper eyelids or genital mucous membrane. Infection cannot be produced by inoculation beneath the skin, into the peritoneal cavity or into the blood vessels.

The incubation period averages 31 days (22–35). Exceptionally it may be reduced to 15 or prolonged to 49 days.

Chancre.—After a period of incubation has elapsed, small, rose-coloured, hardly visible pimples make their appearance at the site of inoculation. Two or three days later the lesion is redder and a small scale forms on the surface followed by ulceration and induration of the subjacent tissues, reproducing exactly the appearance of the chancre as seen in man. The corresponding glands become enlarged and indurated.

Secondary manifestations.—Secondary lesions have been observed in 66 per cent. of chimpanzees inoculated and are recognizable about a month after the appearance of the chancre.

The rash is very difficult to detect because chimpanzees suffer naturally from rashes on the skin which may very easily be mistaken for a typical rose rash (Roux and Metchnikoff). On the other hand, papules and mucous patches are seen and inoculation from these into another chimpanzee results in infection of the latter. During the secondary stage, Roux and Metchnikoff have observed attacks of paraplegia coming on a few weeks after the appearance of the chancre but soon passing off. The spleen is frequently enlarged.

One of the chimpanzees inoculated by Roux and Metchnikoff suffered from a malignant form of syphilis and died about 10 months after infection.

Tertiary manifestations.—Tertiary lesions have not up to the present time been observed in chimpanzees.

II. Orang-outang.—Inoculation of syphilitic material into an orang-outang invariably produces a chancre (Neisser, Roux and Metchnikoff).

The incubation period is shorter than in the chimpanzee and averages 24 days.

The chancre is not so distinct as in the chimpanzee. Secondary manifestations apparently never develop.

III. Gibbon.—The results of the inoculation of the gibbon are almost the same as in the orang-outang (Metchnikoff and Neisser). Secondary manifestations are uncommon. Neisser has noticed a papular eruption covering the face, palms of hands, abdomen, buttocks and mucous membranes.

As has been pointed out already the higher apes may be infected by scratching infective material taken from a primary or secondary lesion into the skin of any part of the body. When material from tertiary lesions was used five only out of seventeen experiments were successful (Neisser, Sieber and Schacht). Hoffmann inoculated four animals with the blood of a syphilitic man (taken 40 days and 6 months after infection) while it was still warm and before it had coagulated. Two of the animals developed syphilis. The same observer succeeded in infecting a monkey with mucus from the nose of a diseased person.

Investigation shows that the virus of syphilis diffuses very rapidly through the tissues. Excision of the site of inoculation 8 hours after infection does not prevent the development of a chancre. During the incubation period the bone-marrow and

spleen may contain the virus and inoculation of either of these tissues into monkeys may result in infection.

IV. The lower monkeys.—The lower catarrhine monkeys may be infected with syphilis but the proportion of successful inoculations is very variable. Roux and Metchnikoff taking the results of their inoculations of macacus and cynocephalus monkeys together (*M. rhesus*, *M. cynomolgus*, *M. sinicus*, *C. hamadryas*) succeeded in infecting 50–60 per cent. They affirm that the only chance of success lies in inoculating the material on the orbital arches or genital mucous membrane. In experiments on the same species of monkeys, Finger and Landsteiner infected 87 per cent. by making deep scarifications and inoculating a large amount of the virus. Thibierge and Ravaut say that macacus monkeys can always be infected if inoculated on the free margin of the eyelids. The incubation period is shorter than in the anthropoid apes and averages 23 days. The primary sore takes the form of an ulcer and the subjacent tissue is infiltrated but not characteristically indurated. In *M. rhesus* the chancre, as a rule, has the appearance of a papule. There is no enlargement of the glands. Secondary lesions have not been observed.

As a result of their experimental inoculations, Roux and Metchnikoff lay down the following law: *the shorter the incubation period, the less severe the syphilitic infection.*

V. Rabbits.—The rabbit can be infected by inoculating the virus into the eye. Thus, material from hard chancres or secondary papules when inoculated into the anterior chamber of the eye of a rabbit leads to the development of a small swelling of the cornea in 50 per cent. of cases about 10 days after inoculation; this swelling is subsequently accompanied by a parenchymatous keratitis with a very marked lymphocytosis (Bartarelli). Microscopical examination shows the presence of treponemata in very large numbers in the anterior part of the infected cornea but they are never found in the epithelial layer. If a small portion of the infected cornea be transferred to the anterior chamber of the eye of a normal rabbit a similar lesion containing actively multiplying spirochætes develops.

The rabbit virus is capable of infecting monkeys. Bartarelli produced very distinct chancres and syphilitic keratitis in *Macacus cynomolgus* by inoculating the monkeys either on the cornea or by scarifying the skin with material from the cornea of the fifth passage rabbit.

Bartarelli's results have been confirmed by Sherber, Greef and Clausen and others.

To ensure a successful result Bartarelli recommends inoculating the infected tissue, or scraping into the anterior chamber of the eye. Alternatively, the margin of the cornea may be scarified and rubbed with the virus; it is important that the eyelids be held open for a little while after the operation. The material should previously to inoculation be well washed in sterile water to remove any contamination that may be present on the surface.

VI. Some of the other lower animals appear to be susceptible to an experimental infection with syphilis.

The rabbit virus on inoculation into guinea-pigs produces keratitis with multiplication of the treponemata (Bartarelli).

Dogs (Hoffmann and Bruning), sheep (Bartarelli) and cats (Levaditi and Yamanouchi) can all be infected by scarifying the cornea.

Siegel produced indurated nodules at the site of inoculation in mice 2 days old by inoculating them with the virus of syphilis. The spleen of one of these when inoculated into a monkey produced a very distinct syphilitic lesion.

Experiments on immunization.

It is a general rule that an individual with a chancre cannot be re-infected, but the rule is not without exceptions even in the case of the human subject (Queyrat). In monkeys, a second inoculation 10 days after the chancre has appeared may give rise to a second chancre (Roux and Metchnikoff).

Individual human subjects exhibit considerable variation in their susceptibility to syphilis and a similar variation is noticeable in the lower animals. Young monkeys are much less susceptible than adults or old monkeys, and among some species while the adults are easily infected the young animals are immune (Roux and Metchnikoff).

It would seem that the virus of syphilis can, *in certain cases*, become attenuated by passage through the lower monkeys and that it then gives rise in the higher apes and perhaps in man to a minimal local lesion which is not followed by secondary manifestations and which moreover immunizes the inoculated individual against a second inoculation. Unfortunately, the results upon which this conclusion is based are very inconstant as will be seen from the accounts of a few typical experiments which follow, and the method cannot be regarded as a sure means of attenuating the virus.

Metchnikoff and Roux inoculated a chimpanzee with a virus from a bonnet monkey (*M. sinicus*). Small insignificant chancres appeared but no secondary lesions and the chimpanzee was immune to a subsequent inoculation with a human virus. The experiment was repeated several times but the above result was never again obtained.

Finger and Landsteiner obtained a virus which after passing through six baboons (*C. hamadryas*) in succession set up in a seventh an insignificant lesion which lasted only a short time. In another experiment the virus showed no attenuation after twelve passages.

Roux and Metchnikoff passed a virus from a chimpanzee through a number of *M. rhesus*. As it passed from rhesus to rhesus the primary sore became more and more benign and appeared earlier, the incubation period at the same time falling from 19–7 days. After eleven such passages, the virus was very attenuated for rhesus monkeys and harmless to the chimpanzee.

Roux and Metchnikoff inoculated a man 79 years of age, and who was not known ever to have had syphilis, on the fore-arm with an human virus which had been passed through five monkeys, a baboon, two chimpanzees, and two bonnet monkeys (*M. sinicus*). Twelve days after the inoculation two insignificant papules appeared which lasted only a few weeks and were unaccompanied by any other lesion. The controls (a chimpanzee and a bonnet monkey) developed typical chancres after incubation periods of 23 and 31 days respectively.

Sub-cutaneous inoculation of anthropoid apes with syphilitic material does not produce the disease. This being so it might be thought that sub-cutaneous inoculation would have an immunizing effect but by experiment this is found not to be the case; animals inoculated sub-cutaneously are just as easily infected by scarification as the controls (Metchnikoff, Roux and Neisser).

The syphilitic virus after being heated to 51° C. has no immunizing action when inoculated into susceptible animals.

Serum therapy.—Up till now all attempts to obtain an antisiphilitic serum have failed. Roux and Metchnikoff attempted the preparation of a serum by inoculating macacus monkeys and baboons which had recovered from a primary sore with large quantities of a virus of human origin. The serum of these monkeys sometimes neutralizes the human virus *in vitro*: a mixture

of serum and virus is without effect on monkeys, but the serum alone is useless when the virus has been already inoculated. No immunizing substances are present in the blood of persons suffering from the disease nor in the broken-down tissues of gummata.

SECTION II.—MORPHOLOGY.

1. Microscopical appearance.

The *Treponema pallidum* may be examined in the fresh, unstained condition with an ordinary microscope if a powerful source of light (e.g. an inverted incandescent burner) (fig. 111, p. 118) and a good oil-immersion lens be used. Under these conditions, the organism appears as a small, spiral filament with pointed ends and exhibits very active movements of rotation and flexion. The spiral arrangement is equally evident when the treponema is actively moving and when it is at rest: the spiral is complete and has a corkscrew appearance.

The examination of treponemata in the fresh condition is much facilitated



FIG. 344.—*Treponema pallidum*. Scraping from an hard chancre. Dark-ground illumination. Epithelial debris, leucocytes, bacteria and treponemata. (After Gastou.)

by the use of dark-ground illumination (p. 123) which is also of great assistance when making a diagnosis. With the ultra-microscope the treponema appears as a brilliant spiral standing out sharply against the black background of the field of the microscope; it exhibits more or less rapid movements of progression, and seems to turn rapidly on itself like a screw and to move like an eel. Sometimes the treponemata have the appearance of "a series of brilliant scintillating points travelling one behind the other in a straight or sinuous line, keeping their respective distances in a sort of Indian file procession" (Gastou).

When stained, the treponema measures 6–15 μ long and about 0.25 μ across. Occasionally much longer forms are encountered; these consist of several parasites attached to each other end to end. The transverse section of the organism is circular.

The turns of the spiral are perfectly regular especially about the centre of

the parasite. They number from six to twelve, though occasionally as many as twenty-six have been seen. At each end there is a filament like a

bacterial flagellum which may be about one-half the length of the body: these filaments proceed by insensible gradations from the body of the organism of which they seem to be a gradually vanishing prolongation.

An undulating membrane is never seen.

Some treponemata appear broader than the normal with a bifurcated end and two flagella (fig. 345); many of these have a Y-shape others that of a V.

Occasionally two treponemata are seen attached by their anterior and posterior ends, but separated intermediately, so as to give the appearance of an elongated, irregularly-shaped O. Such forms are said to represent stages in the longitudinal division of the organism (Schaudinn, Prowazek, and others).

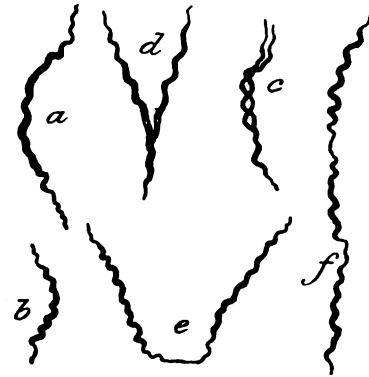

FIG. 345.—*Treponema pallidum*. a, b, normal forms; c, d, e,—O, Y and V-shaped forms; f, three treponemata attached end to end.

Goldhorn, Zettnow, Levaditi are, however, of opinion that the treponema divides transversely and that the forms just described are due to two organisms becoming connected together by their ciliary prolongations or at some point on their bodies.

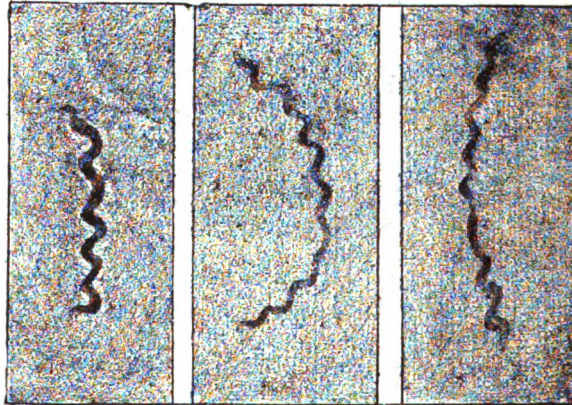

FIG. 346.—*Treponema pallidum*. Congenital syphilitic liver. Giemsa's stain. $\times 4000$. (From the *Bulletin de l'Institut Pasteur*.)

2. Staining methods.

The *Treponema pallidum* stains with difficulty and never other than very lightly, hence the names *Spirochæta pallida* and *Treponema pallidum*. The organism is gram-negative.

Special methods of staining have to be adopted, and it may be convenient to record those which are likely to be most generally met with in works on syphilis, and to specify those of them which appear to be the most useful.

(a) Staining of films.

Giemsa's methods. A. Slow method. Recommended.—1. Dry the films in the air; fix in absolute alcohol for half an hour.

2. Stain for 20 hours in Petri dishes in the following solution:—

| | | | | | | |
|---|---|---|---|---|---|--------------------------|
| Giemsa's solution ¹ (Grübler), | - | - | - | - | - | xxxv drops. ² |
| Distilled water, | - | - | - | - | - | 20 c.c. |

3. Wash in distilled water. Dry with filter paper, or in the warm incubator. Examine with an oil-immersion lens without a cover-glass, or mount in balsam.

The Spirochætes are stained reddish-violet.

B. Quick method. Recommended.—1. Fix for 30 minutes in absolute alcohol; or better, for a few seconds in the vapour of osmic acid (Schaudinn).

2. Stain for 1 hour in the following solution which must be freshly prepared:—

| | | | | |
|--|---|---|----|----------|
| Giemsa's solution, | - | - | - | 10 drops |
| 1 per cent. aqueous solution of carbonate of sodium, | - | - | 10 | „ |
| Distilled water, | - | - | 10 | c.c. |

3. Wash in distilled water. If the preparation be over-stained leave it in water for from 1-5 minutes. Dry. Examine.

C. Rapid method with heat. Recommended. 1. Make very thin films on a slide. Dry. Fix by passing three times through a small Bunsen flame.

2. Drop a large drop of the following mixture, recently made up in a perfectly clean vessel, on to the slide.

| | | | | | | |
|--|---|---|---|---|---------|-----------|
| Distilled water, | - | - | - | - | - | 10 c.c. |
| Giemsa's solution, | - | - | - | - | - | 10 drops. |
| 1 per cent. solution sodium carbonate, | - | - | - | - | 5 to 10 | „ |

Heat the slide with the stain on it for a few seconds over a small flame until steam rises but avoid boiling the solution.

Pour off the stain and flood the slide with a fresh quantity. Heat again. Change the stain in this way three times but let the third lot of stain act for 1-2 minutes.

3. Wash in water. Dry with filter paper. Mount in balsam. Examine.

The methods given above are better than Giemsa's original method which was used by Schaudinn in his early work on the spirochæte. Schaudinn fixed his preparations as above and then stained for 16-24 hours in the following solution:

| | | | |
|---|---|---|-----------|
| Aqueous solution of Giemsa's eosin (0.05 per 1000), | - | - | 12 parts. |
| Aqueous solution of Azur I. (1 per 1000), | - | - | 3 „ |
| Aqueous solution of Azur II. (0.8 per 1000), | - | - | 2 „ |

Marino's method. Recommended.—This is a rapid method and does not entail fixing the films.

¹ Giemsa's solution may be obtained ready made from Grübler of Leipzig. It is prepared by mixing:—

| | | | | | | |
|------------------------------|---|---|---|---|-----|------------|
| Azur II. Eosin, | - | - | - | - | - | 3 grams. |
| Azur II., | - | - | - | - | - | 0.80 gram. |
| Glycerin, | - | - | - | - | 250 | c.c. |
| 60 per cent. methyl alcohol, | - | - | - | - | 350 | „ |

Dissolve the stains in the alcohol then add the glycerin. Leave for 24 hours. Filter.

² 1 c.c. = xxx drops.

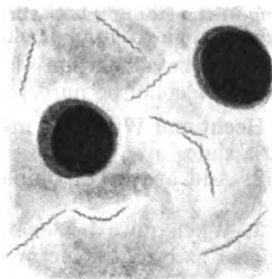

FIG. 347.—*Treponema pallidum*. Film preparation. (Giemsa's stain.) × 1000.

1. Pour about 1 c.c. of the following solution on the dried preparation.

| | | | | | | | |
|-----------------------------|---|---|---|---|---|---|------------|
| Marino's blue, ¹ | - | - | - | - | - | - | 0.10 gram. |
| Absolute methyl alcohol, | - | - | - | - | - | - | 50 c.c. |

2. Stain for about 3 minutes.

3. Without washing, pour a few drops of a 0.005 per cent. aqueous solution of eosin on the film and leave it to stain for 1 or 2 minutes.

4. Wash. Dry. Mount in balsam.

The treponemata will be stained blue and violet.

If the blue has precipitated on account of the preparation having been left too long in the staining bath, flood the film with the blue again for a few minutes, then pass through eosin for 1 minute and finally wash.

[The above solution of Marino's blue will keep for about 2 months if the methyl alcohol be pure.]

Hecht and Wilenko's method.—1. Place a drop of the fluid to be examined on a slide.

2. Add a drop of China ink, mix carefully, spread, leave to dry (half an hour).

3. When quite dry, examine with an oil-immersion lens. The treponemata appear as bright structures on a black background.

Ravaut's method.—This method depends upon the use of "larginé" (albuminate of silver).

1. Make the films, which may be thick, on a very clean slide. Fix in methyl alcohol or in osmic acid vapour.

2. Place the slide in a stoppered bottle containing the following solution, which must have been recently made up and kept in the dark.

| | | | | | | |
|------------------------|---|---|---|---|---|----------|
| Lillienfeld's larginé, | - | - | - | - | - | 2 grams. |
| Distilled water, | - | - | - | - | - | 100 c.c. |

Keep the slide in the stain at 55° C. for 2 hours.

3. Without washing, dip the slide into a 5 per cent. solution of pure pyrogallol. The silver is reduced immediately.

4. Wash in distilled water, return to the larginé bath for half an hour and then pass through the pyrogallol solution again.

5. Wash. Dry. Examine. The treponemata are stained deep brown.

The foregoing is more satisfactory than Stern's silver method. Films on slides are dried in the air, placed in the 37° C. incubator for a few hours, then transferred to a white glass bottle containing a 10 per cent. solution of silver nitrate and exposed to diffused light for a few hours. The slides which now have a metallic appearance are washed in running water, dried and examined. The treponemata are stained deep brown or black.

Borrel and Burnett's method. Recommended.—This method is particularly useful for the rapid detection of the treponema and, according to its authors, is more certain than Giemsa's method.

1. Excise a small portion of the infected tissue and, with the point of a small scalpel, gently scrape a little of it on to a number of slides on each of which a small drop of distilled water has been placed. The dissociated tissue spreads itself out in the water. Dry.

2. Mordant the tissue with Loeffler's ink as in staining for flagella (p. 150).

¹ [To prepare Marino's blue mix :—

| | | | | | | |
|-----------------|---|---|---|---|---|-----------|
| Methylene blue, | - | - | - | - | - | 0.5 gram |
| Azur, | - | - | - | - | - | 0.5 " |
| Water, | - | - | - | - | - | 100 grams |

in a 0.5 per cent. aqueous solution of carbonate of soda. Incubate at 37° C. for 24-48 hours. Add an aqueous solution of eosin. Filter. A powder is thus obtained soluble in water and methyl alcohol.]

3. Stain with Ziehl's fuchsin as for flagella (p. 151).

Reitmann's method.—This is an application of Sclavo's method for staining bacterial flagella.

1. Fix thin films in absolute alcohol for 10 minutes.
2. Wash in distilled water.
3. Wash for 5 minutes in a 3 per cent. solution of phosphotungstic acid.
4. Wash in water, then in 70 per cent. alcohol.
5. Stain in Ziehl's fuchsin, warming until steam just begins to rise.
6. Wash in 70 per cent. alcohol, then in distilled water. Dry.

Herzheimer's method.—1. Prepare films on slides and fix in absolute alcohol.

2. Stain for a quarter-of-an-hour in an aqueous solution of gentian-violet saturated in the warm.

3. Wash. Dry. Mount in balsam.

Herzheimer and Huber's method.—1. Fix for 10 minutes in absolute alcohol.

2. Stain in the following solution, which must be filtered just before use, for 16–24 hours.

| | | | | | | |
|------------------------------|---|---|---|---|---|------------|
| Nile blue (or Capri's blue), | - | - | - | - | - | 0.10 gram. |
| Distilled water, | - | - | - | - | - | 100 c.c. |

3. Wash in distilled water. Dry.

Proca and Vasilescu's method.—1. Fix for 30 minutes in absolute alcohol.

2. Immerse in the following mordanting solution for 10 minutes.

| | | | | | | |
|-----------------------|---|---|---|---|---|-----------|
| Liquid carbolic acid, | - | - | - | - | - | 50 grams. |
| Tannin, | - | - | - | - | - | 40 " |
| Distilled water, | - | - | - | - | - | 100 " |
| Basic fuchsin, | - | - | - | - | - | 2.5 " |
| Absolute alcohol, | - | - | - | - | - | 100 c.c. |

Mix the carbolic acid, tannin and water and then add the fuchsin after dissolving it in the alcohol.

3. Wash in distilled water.

4. Stain for 5 minutes in carbol-gentian-violet.

5. Wash in water. Dry.

Oppenheim and Sachs' method.—No preliminary fixing of the film is required and the treponemata are stained without having been dehydrated in alcohol, with the result that the transverse diameter of the parasites is said to appear larger than when they are treated by the classical methods.

1. Dry the film.

2. Without fixing, flood it with the following solution:

| | | | | |
|---|---|---|---|---------|
| Saturated alcoholic solution of gentian-violet, | - | - | - | 10 c.c. |
| 5 per cent. carbolic acid in water, | - | - | - | 100 " |

Heat the stain over a small flame until steam just begins to rise.

3. Wash. Dry. Mount in balsam.

Davidson's method.—1. Dry the film. Fix in absolute alcohol for 10 minutes.

2. Stain for 1–10 hours in a saturated aqueous solution of Muhleimer's cresyl-violet R extra. The stain must be freshly prepared and filtered before use.

3. Wash in distilled water. Dry. Mount in balsam.

Zabolotny's method.—Dry. Fix. Mordant with a 5 per cent. solution of carbolic acid. Stain in the warm for 15 minutes in a mixture containing 0.1 per cent. azur solution and 0.2 per cent. eosin solution.

Simonelli and Bandi's method.—In this method, as in Marino's, preliminary fixation is eliminated, the stain being dissolved in methyl alcohol.

Method of preparing the stain.—Dissolve 1 gram of water-soluble eosin in a litre of water, and, in another vessel, 1 gram of methylene blue in a litre of water. Mix the two solutions and let the mixture stand for a week. Filter through an unfolded filter paper and wash the precipitate with distilled water. Dry the precipitate in the air then dissolve it in sufficient methyl alcohol to yield a saturated solution.

Method of staining.—1. Dry the film and, without fixing, stain in the above solution for about 10 seconds.

2. Wash very quickly in distilled water.

3. Blot with filter paper. Examine without a cover-glass.

Goldhorn's method is merely a complicated modification of the preceding.

Hoffmann and Halle's method.—Fix the wet film with osmic acid.

1. Pour into a small capsule of about 5 cm. diameter :

| | |
|---|-----------|
| 1 per cent. aqueous solution of osmic acid, - - - | 5 c.c. |
| Crystallized acetic acid, - - - | 10 drops. |

Place the capsule inside a glass vessel closed with a ground-glass cover.

2. Lay a well-cleaned slide on the capsule for a couple of minutes.
3. Spread the material to be examined on this slide with a platinum spatula.
4. Then, without drying the film, replace the slide on the capsule and leave it exposed to the vapours for about 2 minutes.
5. Dry the film quickly by gently heating it.
6. Flood the preparation for a minute with a weak (pale red) solution of potassium permanganate.
7. Wash in distilled water. Blot with filter paper.
8. Stain with Giemsa's solution as described above.
9. Wash. Dry. Examine.

The treponemata stain bluish-red even in the thick parts of the film. The flagella are also rendered distinctly visible.

(β) Flagellum staining.

The flagella of the *Treponema pallidum* may be stained by Lœffler's original method (p. 149) or modifications of it.

Borrel and Burnett's method (p. 728) gives very good results as does also Hoffmann and Halle's method.

Schaudinn employed Lœffler's method, thus :

1. Fix in absolute alcohol for 10 minutes.
2. Mordant with fuchsin ink (p. 150) heating the solution gently for 30-60 seconds.
3. Wash in distilled water, then in 75 per cent. alcohol.
4. Stain with gentle heat for about 1 minute in a large drop of the following solution :

| | |
|--------------------------------------|-------------------|
| Aniline water, - - - - - | 100 c.c. |
| Basic fuchsin, - - - - - | Q.S. to saturate. |
| 1 per cent. soda solution, - - - - - | 10 to 15 drops. |

5. Wash in distilled water. Dry.

(γ) Methods of staining sections.

Bertarelli, Volpino, and Bovero's method.—These observers were the first to successfully stain the *Treponema pallidum* in sections of syphilitic tissues. The method, a modification of van Ermengem's method for staining flagella, is based upon the reduction of silver nitrate in the tissues of the treponema. The results obtained were, at the time, criticized by German writers, but there can now be no doubt as to the true nature of the "Spirochætes of silver" as the treponemata were described.

1. Fix the tissues in absolute alcohol (p. 188), embed in paraffin and cut into very thin (\bar{c} a 5μ) sections.

2. Immerse the sections in a solution of silver nitrate for 24-48 hours.

| | |
|---------------------------------------|-----------|
| Crystals of silver nitrate, - - - - - | 0.5 gram. |
| Distilled water, - - - - - | 100 c.c. |

3. Wash in distilled water.
4. Transfer the sections to van Ermengem's tanno-gallic solution (p. 149) for a quarter-of-an-hour.
5. Wash in distilled water.
6. Return the sections to the silver solution until they assume a brownish-yellow colour.
7. Wash. Dehydrate in absolute alcohol. Wash in xylol and mount in balsam.

The spirochætes stain black, and stand out prominently against the deep yellow colour of the tissues.

Levaditi's methods.—In order to avoid the deposits which are often formed when Bertarelli's method is used, Levaditi stained the tissue in bulk in the silver solution. Levaditi has described two methods, the second of which gives the better results.

First method.—1. Fix a small piece of tissue in 10 per cent. formalin for 24 hours.

2. Harden in absolute alcohol for 24 hours.

3. Wash in distilled water for 5 minutes.

4. Immerse the tissue in a solution of silver nitrate in a ground-glass stoppered bottle and keep it in the dark for 3 days at a temperature of 38° C.

| | | | | | | | | | |
|-----------------------------|---|---|---|---|---|---|---|------|--------|
| Crystals of silver nitrate. | - | - | - | - | - | - | - | 1.50 | grams. |
| Distilled water, | - | - | - | - | - | - | - | 100 | c.c. |

5. Wash in water. Then immerse for 24 hours at the temperature of the laboratory in the following solution :

| | | | | | | | | | |
|------------------|---|---|---|---|---|---|---|-----|--------|
| Pyrogallol, | - | - | - | - | - | - | - | 4 | grams. |
| Formalin, | - | - | - | - | - | - | - | 5 | c.c. |
| Distilled water, | - | - | - | - | - | - | - | 100 | .. |

6. Wash in distilled water.

7. Dehydrate in 80 per cent. alcohol, then in absolute alcohol, clear in xylol and embed in paraffin.

8. Cut and mount the sections carefully (p. 215) and stain them on the slide for 10 minutes with Giemsa's solution undiluted.

9. Wash in water and differentiate in absolute alcohol to which a few drops of clove oil have been added.

10. Wash in absolute alcohol, oil of bergamot and xylol and mount in balsam.

The re-staining of the groundwork with Giemsa's solution (Stage 8) is not essential ; it is better to omit it.

Second method (Levaditi and Manouélian). Recommended.—This method

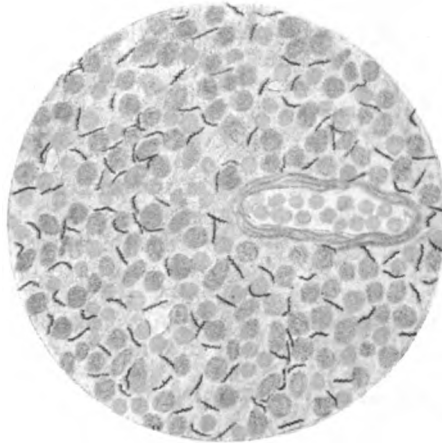

FIG. 348.—*Treponema pallidum*. Section of lung. Silver impregnation method.
(Oc. 2, obj. 4th, Zeiss.)

differs from the preceding in the introduction of *pyridine* which shortens the time of staining and facilitates the reduction of the silver salt.

1. and 2.—Cut the tissues into pieces about 1–2 mm. square, then fix and harden as in the first method.

3. Wash in distilled water until the pieces fall to the bottom of the vessel.

4. Leave the pieces of tissue in a ground-glass stoppered bottle for 2–3 hours at the temperature of the laboratory then for 3–5 hours at 50° C. in 50 c.c. of the following solution :

| | |
|---|---------|
| 1 per cent. aqueous solution of silver nitrate, - - - | 90 c.c. |
| Pyridine, - - - - - | 10 " |

5. Wash in distilled water.

6. Immerse for 3 or 4 hours at the temperature of the laboratory in the following solution which must be freshly prepared.

| | |
|---|---------|
| 4 per cent. aqueous solution of pyrogallol, - - - | 90 c.c. |
| Pure acetone, - - - - - | 10 " |
| Pyridine, - - - - - | 17 " |

7. On taking out of the reducing bath, dehydrate in absolute alcohol, clear in xylol and embed in paraffin.

8. Cut, stain the sections on the slide with a 2 per cent. aqueous solution of toluidine blue (Buschke and Fischer) and differentiate in absolute alcohol or Unna's ether-glycerin solution. (This step is not essential but by adopting it the groundwork is stained blue and the relationship of the parasites to the cells can be made out.)

9. Dehydrate in absolute alcohol, oil of bergamot and xylol. Mount in balsam. The treponemata are stained black.

SECTION III.—THE DETECTION AND IDENTIFICATION OF THE TREPONEMA PALLIDUM IN THE TISSUES.

The distribution of the *Treponema pallidum* in syphilitic tissues is very irregular. In similar lesions, the parasites are in some cases numerous, in others so few in number that several preparations have to be examined before one or two are seen. Further, a delicate technique has to be adopted, so that several examinations are in most cases essential.

In the lesions of congenital syphilis the treponemata are far more numerous than in the lesions of acquired syphilis. In the latter case the parasites can most easily be found in the primary lesions and in the secondary papules. Treponemata are rarely seen either in the blood or in tertiary lesions.

Herscheimer and Opificus advise the routine use of preparations made during the night as they believe that the micro-organism is then present in larger numbers.

1. Collection of material.

Chancre.—Cleanse the surface of the chancre carefully to expose the dermis. Scrape it gently and repeatedly with a vaccinating lancet in order to produce a slight exudation of serum, a sort of *serous dew*, and prepare films with the exudate (Thibierge, Ravaut and Le Sourd).

Alternatively, the chancre may be partially or totally excised and so provide material for cutting sections. This, however, may not always be practicable.

Rose spots and papules.—The simplest method is to scarify the part and collect the exudate. Better, after lightly scarifying, place a small Bier's cupping glass (Zabolotny) or small blister over the lesion and use the serous fluid which collects.

Gummata.—The fluid in softened gummata contains no treponemata. Material from the walls of gummata must be used for the purpose of demonstrating the organism.

Lymphatic glands.—Puncture the gland with a large-bored needle and aspirate the juice with a sterile syringe.

Blood.—Examination of blood-films generally gives negative results, so that it is desirable to select one or other of the following special methods in searching for the parasite.

Nattan-Larrier and Bergeron's method.—1. Collect 10 c.c. of blood from a vein at the bend of the elbow (p. 193).

2. Distribute the blood into two flasks each containing 100 c.c. of distilled water.

3. Let the blood hæmolyze and then centrifuge.

4. Prepare thin films with the centrifuged deposit. Dry. Fix in a mixture of alcohol-ether.

5. Stain by Bertarelli's method (p. 730); or with Heidenhain's iron hæmatoxylin.

Bavant and Ponselle's method.—1. Let the blood fall, drop by drop, into 30 c.c. of distilled water.

2. Collect the clot, wash it, blot, harden, stain by Levaditi's method and cut like an histological preparation.

Næggerath and Staehelin's method.—1. Collect about 1 c.c. of blood in a tube containing a 0.33 per cent. aqueous solution of acetic acid.

2. Leave the blood to hæmolyze. Centrifuge.

3. Prepare films with the deposit. Dry. Fix and stain by Giemsa's slow method.

2. Methods of examination.

In examining material for the *Treponema pallidum* it is always necessary to bear in mind that in many syphilitic affections (ulcerated chancres, mucous plaques, suppurating gummata, etc.) other micro-organisms are present in addition to the specific parasite, so that, if a spirochæte be found, great care must be exercised to make certain that the one seen is in fact the *Treponema pallidum*, because numerous other spirochætes, differing more or less from the specific spirochæte of syphilis, are often found in the tissues (*vide infra*).

I. Examination of fresh material.—The examination of fresh material is very unreliable; the extreme tenuity of the organism and its feeble powers of refraction render its detection difficult and demand very acute powers of observation on the part of the investigator. It was, however, by this method that Schaudinn discovered the treponema.

Scholtz recommends examining the material in a hanging-drop preparation. The sweated serum or scrapings, rubbed up in a drop of normal saline solution, are examined in a cell or between a slide and cover-glass. Fluid from a pemphigus bulla and blister fluid should be examined in the same way.

The material must be examined by artificial light (an inverted incandescent burner (p. 118) is very useful) and with an oil-immersion lens (Levaditi and Roche).

II. Examination with dark-ground illumination.—This is not only the most rapid but perhaps the most reliable method for finding the treponemata (Landsteiner and Mucha, Gastou).

Arrange the dark-ground illuminator as directed on p. 125. If an oil-immersion lens be used place a diaphragm in the objective, but a high power dry lens is quite suitable. An inverted incandescent burner or Nernst lamp is a good source of light. Everything being in order, place the drop of fluid either pure or diluted in a little normal saline solution between the slide and cover-glass (for details *vide p. 127*).

Under these conditions, the treponema stands out brightly against the black back-ground of the preparation (fig. 344) and is easily seen. The most

difficult part of the experiment is to differentiate the *Treponema pallidum* from the various similar spirochætes which are not infrequently present in these preparations (fig. 349). A certain amount of experience is necessary before it is possible to be certain of the diagnosis.

III. Examination of stained preparations.—With regard to the staining of films and sections for the detection of the treponema, Borel and Burnett's method is rapid and is particularly recommended. Giemsa's method is also good. For sections, the silver impregnation method is undoubtedly the best.

3. Identification of the organism.

The *Treponema pallidum* is differentiated from all other spirochætes by several characteristics.

1. It has an average length of 10–15 μ but is often longer and is extremely slender, measuring on an average 0.25 μ transversely.

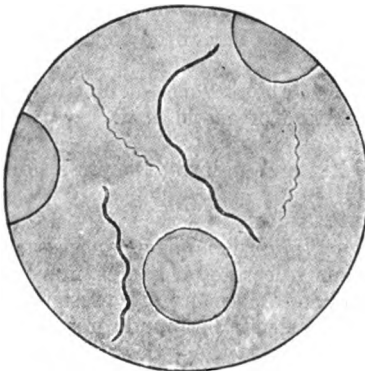

FIG. 349.—*Treponema pallidum* and *Spirochæta refringens*. (After Schaudinn.) Syphilitic papilloma. $\times 1500$.

2. Its index of refraction is very low indeed in fresh preparations, so that with an ordinary microscope it is only visible with a very good apochromatic objective. On the other hand, it is readily visible by dark-ground illumination.

3. It has no undulatory membrane.

4. Its pointed ends terminate in a long ciliary filament.

5. It is circular in transverse section.

6. It is in form a complete spiral like a corkscrew. This characteristic spiral arrangement is seen both when the organism is in motion and when at rest.

7. The turns of the spiral are deep, close and regular. The organism possesses a considerable degree of elasticity so that it is not easy to deform it.

8. *In vitro* its vitality is low so that when watched under the ultra-microscope the movements cease in 5–6 hours at the temperature of the laboratory.

9. The treponema stains with difficulty and is coloured red with Giemsa's solution.

Spirochætes closely resembling the *Treponema pallidum*.

The following are the principal spirochætes with which the *Treponema pallidum* is likely to be confused :

A. Spirochæta refringens.—This spirochæte occurs in smegma, and in ulcerating lesions of the skin. It is sometimes found associated with the *Treponema pallidum* in ulcerating syphilitic lesions, but in these cases it occurs near the surface and not deep in the tissues.

The *Spirochæta refringens* is larger and longer than the *Treponema pallidum* and in the fresh condition is highly refractile. The turns of the spiral are fewer in number and of greater amplitude, less regular and flattened. The perioplast often simulates an undulatory membrane. There is only one flagellum and this is attached laterally to one of the rounded ends (Levaditi). The movements are much more rapid than those of the *Treponema pallidum* and it is often impossible to follow them under the microscope. It stains easily with the ordinary dyes and stains blue with Giemsa's solution.

B. Spirochæta balanitidis.—Hofmann and Prowazek described this organism as being present in a case of circinate ulcerative balanitis. It

would appear to be identical with the *Spirochæta refringens*, from which it is distinguished only by minor differences in the arrangement of the turns of the spirals. It occasionally has two flagella, attached, as in the case of *Spirochæta refringens*, to the rounded end of the parasite. This is probably the organism which Levaditi succeeded in growing symbiotically with certain anaërobic organisms in collodion sacs filled with heated human serum in the peritoneal cavity of a rabbit.

C. *Spirochæta plicatilis*.—This is a large, thick spirochæte which stains easily. The undulations are widely separated and of large amplitude. It has a large undulatory membrane but no flagellum.

D. *Spirochæta dentium*.—This spirochæte which multiplies in carious teeth (Koch, Müller), more closely resembles the *Treponema pallidum* than any other species (Levaditi).

In common with the *Treponema pallidum* it is an organism of very delicate structure only slightly refractile in the fresh condition, and the turns of the spiral are regular and permanent. It is, however, shorter than the *Treponema*, its average length being 4–10 μ and the turns of the spiral are closer together and not so deep. It stains more easily than the spirochæte of syphilis. Mühlens and Hartmann have been able to grow it outside the body.

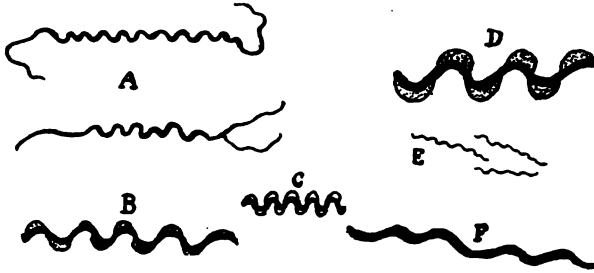

FIG. 350.—Various spirochætes. A, *Treponema pallidum*; B, *S. refringens*; C, Spirochæte from a cancer; D, *S. plicatilis*; E, *S. dentium*; F, *S. vincenti*.

Mühlens grew it in Veillon's tubes containing a mixture of two parts of liquefied agar and one part of horse serum heated to 58–60° C. for half an hour. The serum-agar was sown at 40° C. and the tubes rapidly cooled. After incubating at 37° C. for 8 days very small, whitish, transparent, snow-like colonies were seen in the depth of the agar. It was possible to sow a series of sub-cultures. The cultures were not pathogenic. The spirochætes occasionally had a long, fine, terminal flagellum but often no flagellum at all could be seen. No undulatory membrane was found. In two of the cultures longitudinal multiplication forms having the form of a Y or a V were observed.

E. *Spirochæta buccalis*.—The *Spirochæta buccalis* was described by Cohn as occurring in the human mouth; it is a large spirochæte; the undulations are few in number and of wide amplitude: it stains easily, and has one or two flagella arranged like those of the *Spirochæta refringens*. The undulatory membrane which has sometimes been described in connexion with it would appear to be formed by the débris of the periplast. There should be little or no difficulty in distinguishing between this spirochæte and the *Treponema pallidum*.

F. *Spirochæta vincenti*.—This spirochæte, found in association with fusiform spirilla (p. 574), has the same characters as the *Spirochæta buccalis*. It must be regarded as either very closely related to or identical with that organism (*Spirochæta media* Prowazek).

G. The Spirochætes of malignant ulcers.—In malignant ulcers, Löwenthal

found two species of spirochætes quite different from the *Treponema pallidum*. They both stain blue by Giemsa's method and in both the undulations are irregular and flat:

Spirochæta microgirata is small and delicate measuring 2·5–6 μ . It has four to twelve turns in the spiral and these are so close together as to appear to touch. It stains well with borax-blue.

Spirochæta læwenthalii is thicker than the *Treponema*; the turns of the spiral are irregular and it seems to have an undulatory membrane.

H. *Treponema pallidulum* (*Spirochæta pertenuis*).—Yaws or *Frambœsia* (Fr. Pian) is a contagious and inoculable disease very common in the tropics and characterized by papillomatous lesions which do not affect the mucous membranes. It is caused by an organism very closely related to that of



FIG. 351.—Scraping from an infected mucous papule. Dark-ground illumination. (After Gastou.) Various spirochætes.

sypphilis, and was first described by Castellani under the name *Spirochæta pallidula*.

The following characteristics, according to Castellani and Prowazek, serve to identify the *Treponema pallidulum*: it is a little thicker than the *Treponema pallidum*: the turns of the spiral are rather crowded and irregular: its ends, often coiled up together, are usually rounded and a terminal flagellum is not a constant feature.

SECTION IV.—CULTIVATION EXPERIMENTS.

[Until recently] it has not been possible to grow the *Treponema pallidum* in artificial media.

Volpino and Fontana cut off under aseptic precautions fragments of syphilitic lesions (chancres, papular lesions) and sowed the pieces both aërobically and anaërobically either in human blood, citrated human blood, serum or ascitic fluid and incubated the tubes at 37° C. Various contaminating organisms grew in the culture fluid but in no case was a culture of the *treponema* obtained; in the fragments of the tissues themselves on the other hand a considerable multiplication of spirochætes was demonstrated after about 8–10 days. Even when no spirochætes could be found in the

tissue before sowing they were readily found in it subsequently and had evidently multiplied in the culture tubes.

Levaditi and MacIntosh have grown the treponema in collodion sacs. The virus, obtained from monkeys, was sown in sacs filled with human blood, and in these sacs, placed in the peritoneal cavity of a *Macacus cynomolgus*, an impure culture of the treponema was obtained. Sub-cultures were grown in series by placing the sacs in the peritoneal cavities of rabbits; they contained numerous anaërobic organisms were devoid of virulence and had no immunizing properties. All attempts to isolate the treponema in pure culture failed.

[Noguchi¹ has devised a method by which he has been able to grow the *Treponema pallidum* in pure culture outside the body. Moreover the inoculation of these pure cultures has resulted in the development of typical syphilitic lesions in the rabbit.

[*Medium*.—After trial of many culture media Noguchi finds that the most suitable consists of a mixture of 1 part of sheep, horse or rabbit serum with 3 parts of distilled water into which a piece of freshly excised normal rabbit tissue (kidney or testicle) is placed.

[The medium is tubed in quantities of 16 c.c. in each tube and sterilized for 15 minutes on each of 3 successive days at 100° C. A layer of sterile paraffin oil is poured on the surface to render the medium anaërobic and to prevent evaporation. The sterility of the contents of the tubes is determined by incubating the latter at 37° C. for 2 days.

[*Material*.—For sowing the medium Noguchi used portions of the testicles of rabbits which had been infected with material from cases of syphilis in the human subject. By using rabbit tissues the difficulty of contaminating organisms was largely overcome.

[*Conditions of growth*.—For primary cultivations it is essential that the medium shall be incubated under anaërobic conditions. The tubes may be placed in a Bulloch's apparatus which is then exhausted over pyrogallol and the bell jar afterwards filled with hydrogen.

[The serum and tissue forming the culture medium must be slightly alkaline.

[To remove contaminations Noguchi filters through Berkefeld filters as he finds that the treponemata are filtrable after the fifth day.

[*Results*.—The rabbits providing the material for cultivation had been inoculated with material from ten different sources. Cultivations were obtained from six of these. Cultivation was difficult and many failures were experienced. Once only did Noguchi obtain a pure culture at first trial. One strain had passed through twenty-five sub-cultures.

[The treponemata begin to multiply after about 48 hours' incubation and continue slowly to increase for 4 or 5 weeks. They attain their natural size in 10–12 days and later elongate and form tangled masses.

[In appearance the cultivated treponemata are quite typical and quite indistinguishable from treponemata obtained from human or experimental animal sources.

[With two of the cultivated strains Noguchi was able to produce lesions in the testicles of rabbits which in every way resembled the lesions produced by the inoculation of material from cases of human syphilis.]

SECTION V.—SERUM DIAGNOSIS.

Wassermann, Neisser and Bruck conceived the idea of applying to the diagnosis of syphilis the complement fixation method of Bordet and Gengou. As it was impossible to obtain cultures of the *Treponema pallidum*, Wassermann used as the antigen the liver of a congenitally syphilitic infant which, as is well known, contains very large numbers of the organism. He showed that an extract or fragment of such a liver will, in the presence of heated syphilitic

[¹ *Journal of Experimental Medicine*, vol. xiv.]

serum and guinea-pig complement, fix the complement ; hence the conclusion that in syphilis the serum contains anti-bodies. Wassermann devised a clinical method for the diagnosis of syphilis based on this observation and deduction. It may be stated as follows :—

1. If an hæmolytic system (p. 232) be added to a mixture of extract of syphilitic liver, heated syphilitic serum and complement, no hæmolytic occurs.
2. If an hæmolytic system be added to a mixture consisting of the same extract of liver, heated non-syphilitic serum and complement, hæmolytic occurs—there has been no fixation of complement.
3. Further, if the cerebro-spinal fluid from a case of general paralysis or tabes (diseases which are known to be of syphilitic origin) be mixed with an extract of a syphilitic liver and complement the latter is fixed as in the case of a syphilitic serum.

Experience has shown that there are certain exceptions to the above rules.

The reaction is, as a rule, positive in the secondary stage of syphilis where lesions are present (65–80 per cent.). The percentage of cases in which positive results are obtained is smaller in primary syphilis, and also and especially when the disease is of long standing and when at the time of examination no symptoms are manifest (20–58 per cent.). It is often negative in cases—even when they are of recent origin—which are being treated with mercury (c̄a 30 per cent.). Finally, experiments have been recorded in which a positive reaction has been obtained with the serum of persons free from syphilis and with the serum of non-infected monkeys.

The reaction is therefore only reliable when it is distinctly positive. A negative reaction merely constitutes a presumption in favour of the non-existence of syphilis.

In general paralysis, Wassermann's reaction is nearly always positive if the cerebro-spinal fluid be used in the test (93 per cent.), but often negative if the blood serum be employed (58 per cent.). It follows therefore that the cerebro-spinal fluid should always be used in these cases.

The nature of Wassermann's reaction.—Wassermann's reaction is not, however, to be explained on the assumption that syphilitic anti-bodies are present: Armand-Delille, Levaditi and Marie, and others repeating Wassermann's experiments were soon able to show that the same results are obtained when an extract of the liver of a new-born but non-syphilitic infant is substituted for the liver of a syphilitic infant. This observation proves that there is no analogy between the extract of syphilitic liver and a true antigen. And Levaditi and Marie have also shown that the cerebro-spinal fluid in general paralysis which gives the Wassermann reaction contains no true syphilitic anti-bodies ; for it is incapable of destroying or diminishing the virulence of the treponema *in vitro*.

Finally Landsteiner, Levaditi and Yamanouchi, Porgès and others have shown that the reason why the liver extract, in the serum-reaction in syphilis, is able to fix the complement is because it contains certain well-defined substances soluble in alcohol—lecithin on the one hand, and bile salts on the other. In Wassermann's reaction the extract of liver can be replaced by an emulsion or solution of these substances.

Levaditi and Roche conclude that the serum-reaction in syphilis would not appear to be due to the interaction of antigen and anti-body in the ordinarily accepted meaning of those terms and is, further, in no way connected with the presence of the treponema. The fact would appear to be rather that during an attack of syphilis " the serum becomes enriched in certain colloidal principles which in presence of lipoids and bile salts are easily precipitated

and so fix the hæmolytic complement." There is simply an increase in the body fluids of substances already present though in smaller quantity in normal serum; proof of this is afforded by the fact that normal serum used in large doses will give Wassermann's reaction.

The serum-reaction in syphilis is, however, notwithstanding the theories advanced in explanation of the phenomenon, frequently used as a practical method for the diagnosis of syphilis. The experiments summarized above have much simplified the technique of the reaction and a purely chemical test depending solely upon the precipitation or non-precipitation of the serum in presence of certain substances and especially of bile salts has been devised.

Space will not allow a description of all the modifications of Wassermann's method which have been introduced; his original method therefore, and the methods based upon a chemical reaction which, by reason of their simplicity, are now at the disposal of all medical men, will alone be described.

Wassermann's technique for the serum-diagnosis of syphilis.

The ordinary reagents used in the Bordet-Gengou reaction are necessary for the serum-diagnosis of syphilis.

I. Antigen.—Wassermann used an extract of the liver of a newly-born congenitally syphilitic infant. An extract of the liver of a newly-born non-syphilitic infant serves the purpose equally well.

(a) A portion of the liver, which must be fresh and have been collected with all precautions to avoid contamination, is ground up very finely with a very small quantity of sterile normal saline solution in a Borrel's mincer or in an agate mortar. The emulsion is poured into Petri dishes and dried *in vacuo* over sulphuric acid. The dried contents of the Petri dishes are collected and ground up in a pepper mill. The brown powder is sifted and stored in the dark in absolutely dry, well-stoppered bottles.

When required for use, take 1 gram of the powder and triturate it in an agate mortar with 25 c.c. of normal saline solution. Leave the emulsion to stand for 10 hours in the ice chest, centrifuge and use the supernatant liquid as the antigen.

(b) An alcoholic extract of the liver may be used (Landsteiner). One part of the dried and powdered liver is placed in a stoppered bottle with 30 parts of absolute alcohol. Leave for 2 days shaking frequently and then filter through paper. For use, dilute this extract with ten times its volume of water.

In the same way, an extract of fresh liver can be made by macerating 10 grams of ground up liver in 100 grams of absolute alcohol.

(c) Levaditi and Yamanouchi, instead of extract of liver, use the following solution:

| | | | | | |
|---|---|---|---|------|--------|
| Taurocholate or glycocholate of sodium, | - | - | - | 1 | gram. |
| Normal saline solution, | - | - | - | 100 | grams. |
| Carbolic acid, | - | - | - | 0.50 | gram. |

However prepared, the antigen must be carefully titrated before being used. For this purpose the experiment will be arranged as described on p. 235, using quantities of 0.05 c.c., 0.1 c.c., 0.2 c.c., 0.3 c.c., 0.4 c.c., and 0.5 c.c., of liver extract. In the subsequent experiments the smallest quantity of antigen which will give complete hæmolysis is used (0.2 c.c., for example).

II. Suspected serum (anti-body).—The patient's serum collected with the aid of a Bier's cupping glass or by puncturing a vein at the bend of the elbow, is left to coagulate. The serum is then separated and heated (inactivated) for half an hour at 55°–56° C. It also must be titrated in the usual manner (p. 236).

In cases of general paralysis cerebro-spinal fluid must be used in place of blood serum. This fluid does not need to be heated because it contains no complement.

III. Complement.—Use guinea-pig complement prepared and titrated as described at p. 235.

IV. Hæmolytic system.—Use sheep red cells and heated (inactivated) anti-sheep rabbit serum (p. 234).

Experimental data.

The reagents being prepared and titrated it is necessary, in order that the test may be quite reliable, to have in addition some serum from a person suffering from syphilis which is known to give a distinctly positive reaction and some serum from a non-syphilitic person which gives a negative reaction. In this way a series of controls is available for comparison and the chances of error are, as far as possible, avoided.

The experiment will be arranged as follows in accordance with the rules laid down on p. 236.

| | I.—Mix and incubate for one hour and a half at 37° C. | | | | II.—Add after an hour and a half and incubate half an hour at 37° C. | | RESULTS. | |
|------------|---|-------------------------|-------------|-------------------------|--|-------------------------|-----------------------------|---------------------------------|
| | Extract of liver. | Heated suspected serum. | Complement. | Normal saline solution. | Emulsion of red cells. | Heated hæmolytic serum. | If the serum is syphilitic. | If the serum is not syphilitic. |
| Tube No. 1 | 0·20 c.c. | 0·20 c.c. | 0·10 c.c. | 0·40 c.c. | 1 c.c. | 0·10 c.c. | No hæmolysis. | Complete hæmolysis. |
| Tube No. 2 | 0·30 c.c. | 0·20 c.c. | 0·10 c.c. | 0·30 c.c. | 1 c.c. | 0·10 c.c. | No hæmolysis. | Hæmolysis. |
| Control | 0·20 c.c. | Nil. | 0·10 c.c. | 0·60 c.c. | 1 c.c. | 0·10 c.c. | Complete hæmolysis. | |
| Control | 0·30 c.c. | Nil. | 0·10 c.c. | 0·50 c.c. | 1 c.c. | 0·10 c.c. | | |
| Control | Nil. | 0·20 c.c. | 0·10 c.c. | 0·60 c.c. | 1 c.c. | 0·10 c.c. | Complete hæmolysis. | |
| Control | Nil. | Nil. | 0·10 c.c. | 0·80 c.c. | 1 c.c. | 0·10 c.c. | Complete hæmolysis. | |

Chemical methods of serum diagnosis.

These methods are based on the fact that certain reagents while having no action on normal serum produce a precipitate when brought in contact with syphilitic serums. The results are perhaps less constant than those obtained by Wassermann's reaction.

Methods of Porgès and Meyer.—Syphilitic serum generally produces a precipitate when mixed with lecithin whereas normal serum does not under similar circumstances produce a precipitate.

Technique.—1. Triturate in an agate mortar 0·20 gram of ovo-lecithin (Merck) adding in small quantities at a time 100 c.c. of normal saline solution.

2. Take a number of test-tubes (6-7 mm. diameter) and pour into each 1 c.c. of the lecithin emulsion and 1 c.c. of the suspected serum. As a control prepare similarly a number of tubes but using normal serum. Incubate the tubes for from 4-6 hours at 38° C.

3. On taking the tubes out of the incubator leave them to stand at the temperature of the laboratory before recording the results. The tubes to which the syphilitic serum has been added will show a precipitate which appears first at the surface.

Porges' method. Method recommended.—The reaction in this case depends upon the use of a solution of glycocholate of sodium.

1. Prepare immediately before use a solution consisting of :

| | | | | | | |
|------------------------------|---|---|---|---|---|----------|
| Sodium glycocholate (Merck), | - | - | - | - | - | 1 gram. |
| Distilled water, | - | - | - | - | - | 100 c.c. |

2. Heat the suspected serum for half an hour at 55°-56° C.

3. To each of a series of small test-tubes add :

| | | | | | | |
|------------------------|---|---|---|---|---|--------|
| Heated serum, | - | - | - | - | - | 1 c.c. |
| Glycocholate solution, | - | - | - | - | - | 1 „ |

Prepare similarly a number of tubes with heated normal serum.

4. Leave the tubes at the temperature of the laboratory for 20 hours. A precipitate, most distinct at the surface of the mixture, is formed only in those tubes containing the syphilitic serum.

Klausner's method.—Distilled water produces a precipitate when mixed with syphilitic serum.

1. To a number of small test-tubes add :

| | | | | | | |
|------------------|---|---|---|---|---|----------|
| Suspected serum, | - | - | - | - | - | 0.2 c.c. |
| Distilled water, | - | - | - | - | - | 0.7 „ |

Prepare a number of tubes with normal serum.

2. Leave the tubes for a few hours at the temperature of the laboratory and then examine the reaction. The syphilitic serum alone produces a distinct precipitate and renders the mixture cloudy.

५०

PART V.
THE PROTOZOAN PARASITES.

CHAPTER LV.

THE AMŒBÆ.

Introduction.

Section I.—*Amœba princeps*, p. 745.

Section II.—The intestinal amœbæ, p. 746.

Introduction, p. 746.

Microscopical appearance, p. 747.

I. *Amœba coli*, p. 747. II. *Amœba histolytica*, p. 748.

Methods of detection. Staining methods, p. 748.

Cultivation, p. 750.

Experimental infection, p. 751.

FOR some years past the Protozoa have assumed a position of considerable importance in human and veterinary pathology. In this and the following chapters the various pathogenic species will be briefly described and the methods suitable for their detection and study indicated, but all reference to the classification and biology of the Protozoa will be omitted. For these the reader is referred to treatises devoted to the study of Protozoology.

Among the *Rhizopoda*, the Amœbæ alone are of interest from the point of view of pathology. Amœbæ are frequently found in the human intestine, and one species is the cause of the endemic dysentery of warm climates; other species have been found in ulcerations of the mouth, in dental tartar (*Amœba buccalis*; Gross, Sternberg, Kartulis), in hæmaturia, cystitis and metritis (*Amœba urogenitalis* vel *vaginalis*; Boeltz, Rossi Doria and others) and in the fluid of some malignant abdominal tumours (Miura, Lieberkühn, Leyden).

Before embarking upon a study of the pathogenic amœbæ it will be as well to acquire a certain amount of practice in observing these protozoa, and for this purpose the *Amœba princeps*, a very widely distributed saprophytic species, may be used.

SECTION I.—AMŒBA PRINCEPS.

The *Amœba princeps* is not only a very suitable species for purposes of observation, but specimens can be readily obtained by macerating a little straw in a vessel of water. In such an infusion numerous bacteria will be found, and in addition to other Protozoa, amœbæ appearing as large masses (100 μ in diameter) of granular protoplasm can be seen after a few days.

The amœba consists of an hyaline *ectosarc* surrounding a granular *endosarc* which contains several contractile vacuoles, and a rounded refractile *nucleus* which can be

rendered more conspicuous by treating with acetic acid. The nucleus stains deeply with ammoniacal picro-carmin while the protoplasm is only lightly tinted.

The amœba is an highly mobile organism which alters its shape by the protrusion and retraction of pseudopodia ; by successively altering its shape it is able to move from place to place and to collect food material. A solid particle with which one of the pseudopodia may have come in contact is gradually surrounded and enfolded by the organism and passes into the interior of the protoplasm ; if it be suitable

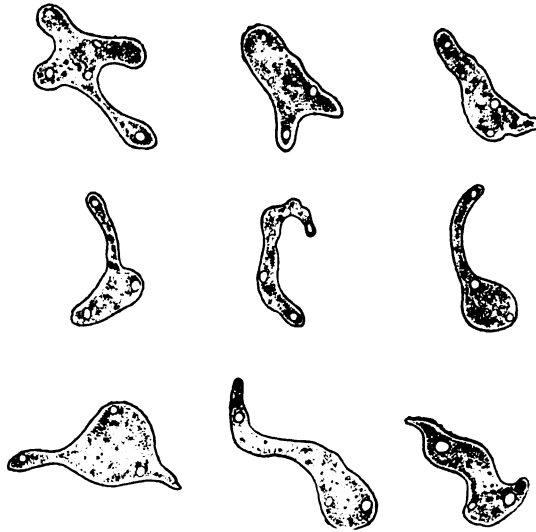

FIG. 352.—*Amœba princeps*. Different shapes assumed by the protozoon in moving across the field of the microscope. (Duration of observation, 35 minutes.)

for food it is gradually dissolved in the substance of the protoplasm, and if not suitable it is soon thrown out. Intra-cellular digestion is accompanied by the secretion of acid in the interior of the protoplasm (Metchnikoff).

Fig. 352 shows the different shapes assumed by an *Amœba princeps* in the field of the microscope while under observation for 35 minutes.

Reproduction takes place in two ways:—When conditions are favourable the amœba divides into two, the nucleus dividing first and the protoplasm afterwards (*schizogony*).

But when the medium in which the amœba is living begins to dry up, the protozoon becomes encysted and enters upon a latent existence. During the encysted stage the nucleus may divide into several secondary nuclei around which the protoplasm collects, forming spores (*sporogony*). When the conditions again become favourable the protecting envelope is lost and the animal assumes its former characteristics.

The *Amœba princeps* can be readily cultivated in infusions of hay or straw (p. 37), on similar infusions solidified with agar or on a jelly of *Fucus crispus* (5 per cent.), etc.

SECTION II.—THE INTESTINAL AMCEBÆ.

Lösch was the first to record the presence of an Amœba in the stools of a man suffering from an ulcerative affection of the intestine : this organism he designated *Amœba coli*. The same parasite was found in the intestines of persons suffering from dysentery (Koch, Hlava) and in dysenteric abscess of the liver (Nasse, Osler). Kartulis has been a strong advocate of the amœbic

origin of dysentery and while he has had the support of a number of observers (Councilman, Laffeur and others), he has been opposed by Tancarat, Quincke and Roos, Massintin, Wilson, and others.

The following facts have been urged against the view that dysentery may be caused by an amœba.

(1) Amœbæ are not constantly found in persons suffering from dysentery.

Laveran only found amœbæ in one case of dysentery out of ten examined by him, Krause and Pasquale in 10 out of 35 cases, Grasser in 45 out of 105 cases, the author in 2 out of 12 cases, Kartulis in 18 out of 35 cases, etc.

(2) Amœbæ are sometimes found in diseases other than dysentery as well as in healthy persons.

Quincke and Roos examined the stools of a number of healthy persons after they had taken a dose of a purgative and found amœbæ in 9 out of 21 cases: Grasser, Wilson, Besson have also found amœbæ in the excreta of healthy men. Sanarelli found amœbæ in considerable numbers in the intestines of guinea-pigs which had died of enteritis following the ingestion of cholera toxin, and in his opinion amœbæ are able to multiply in the intestine of these animals in all cases of toxic enteritis.

(3) Chantemesse, Shiga, and others have described a bacillus which is obviously the cause of a large number of cases of dysentery (Chap. XX.).

Recent investigations, however, have solved this very vexed question of the ætiology of dysentery by showing that the clinical term Dysentery includes two distinct diseases.

(1) An acute, epidemic disease, occurring especially in temperate climates and caused by the bacillus of Chantemesse-Shiga.

(2) A chronic, endemic disease prevalent in warm climates, sometimes accompanied by abscess of the liver and caused by an amœba.

It should be mentioned that in the human intestine two species of amœba may be encountered:

(1) *Amœba coli*, non-pathogenic and frequently present in healthy persons;

(2) *Entamœba histolytica*, or *Amœba dysenterica*, a pathogenic organism and the cause of endemic dysentery (Schaudinn, Jurgens);

and the differences of opinion which are found in the works of some writers are to be explained on the ground of a confusion of these two species one with another.

But though dysentery is generally due to one or other of the organisms mentioned there would appear to be a limited number of cases in which the symptoms are due to other organisms. Thus, cases have been recorded in Germany, Russia and warm countries in which the infecting agent is a parasite known as *Balantidium coli* (*vide infra*), and other cases have been described in which the following parasites appeared to be the cause of the symptoms: a *Spirillum* (Le Dantec at Bordeaux), *Chilodon dentatus* (Guiart), *Trichomonas intestinalis* (Castellani, Billet), the *Hæmatozoon* of Laveran (Billet, Marchoux), *Bilharzia hæmatobia* (Firket, Letulle, etc.).

Microscopical appearance.

1. The *Amœba coli* (*Entamœba coli* of Schaudinn) closely resembles the *Amœba princeps* and even more closely *Amœba pelagia* (Mereschowsky), another protozoon of very wide distribution outside the body.

In the stools it occurs as a clear, slightly greyish, rounded or elliptical mass of protoplasm measuring 15–60 μ in diameter, and as a rule only protruding a single pseudopodium. It consists of a slightly granular endosarc surrounded by a clear ectosarc. The endosarc contains a rounded nucleus and one or more highly contractile vacuoles, and in addition there will usually be seen a number of foreign bodies (bacteria, blood cells, etc.) which have been absorbed by the amœba. The movements of the protozoon are very limited and exceedingly slow, so that it does not travel its own length in a minute. Reproduction takes place by fission, the parasite dividing into two

or eight equal parts. When the conditions are unfavourable, under the influence of cold or desiccation, it becomes encysted: the cysts of *Amœba coli* are large, and measure 10μ or more.

2. *Amœba (Entamoeba) histolytica* is found in the stools of patients suffering from ulcerative dysentery and in tropical abscess of the liver. In the latter, according to Rogers, it can only rarely be found in the pus, but is always present in scrapings from the wall of the abscess. It is distinguished from the foregoing species by its more refractile ectosarc sharply differentiated from the endosarc, and by its slightly elongated nucleus. Its movements are more rapid and the contour of the parasite may be followed with a camera lucida for purposes of sketching them; they are not extensive, being limited to change of shape rather than change of position. The amœba measures on an average 35μ ($10-50\mu$) in diameter, and it multiplies by binary fission. Cysts are formed on the surface of the amœba by a sort of budding process; these cysts are much smaller ($3-6\mu$ in diameter) than those of *Amœba coli* (Schaudinn, Jurgens).

As the causal agent of disease the *Amœba histolytica* passes through the intestinal wall, enters a gland of Lieberkühn, and reaches the sub-mucous layer, where it forms an abscess.

Methods of detection.

In searching for intestinal amœbæ the examination should be conducted on a warm stage and the stools ought to be examined immediately they are passed and while they are still warm. Pick up a small flake of mucus, place it on a slide and compress it beneath a cover-glass in order to get a thin transparent layer. If desirable the stools may be diluted with a warm solution of normal saline solution (0.7 per cent.) or with a freshly prepared Grassi's solution, which is perhaps better.

| | |
|----------------------------|------------|
| Albumin, | 0.20 gram. |
| Sodium chloride, | 1 " |
| Water, | 200 grams. |

The preparation should be examined in the fresh state and unstained. A few cysts will be found in addition to amœbæ and the number of cysts will increase as the stools grow cold. (Use a low power objective to find the amœbas, then turn on an higher power dry lens to study their structure.)

The number of amœbæ in the stools varies considerably: occasionally they are numerous and can easily be found, but at other times they may be present only in small numbers so that it is difficult to detect them. In the latter cases the stools must be examined on several occasions before coming to the conclusion that no amœbæ are present. Musgrave and Clegg prescribe a saline purgative and examine the liquid part of the stools, but the following method devised by Vincent gives better results.

Vincent's method.—Flatten out a flake of mucus as described above and run a drop of a 1 per cent. aqueous solution of methylene-blue under the cover-glass. All the structures in the preparation with the exception of the amœbæ take up the stain immediately, leaving the latter sharply defined on a blue background. As the dye reaches the amœbæ they throw out pseudopodia and move about actively for a few minutes; then the movements become slower and the parasites gradually take up the dye, the nucleus being the last part to stain; finally the movements cease altogether and the parasite dies.

An aqueous solution of neutral red may be used instead of methylene blue: the amœbæ then stain pink and the other structures brick-red.

Staining methods.—The structure of the amœbæ may be studied in stained preparations, but before staining, the organisms must be fixed. Kartulis, however, recommends staining dried preparations without fixing them.

(i) For an *ex tempore* preparation fix the amœbæ by running a drop of a 1 per cent. solution of chromic acid under the cover-glass: then stain by running in a drop of alum-carmin.

(ii) For permanent preparations several methods have been recommended.

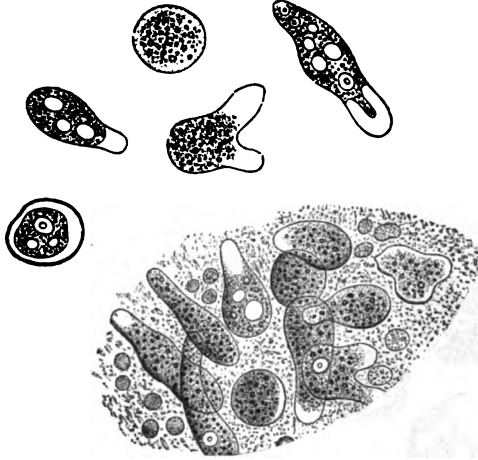

FIG. 353.—*Amœba coli*. (After Lösch.)

A. Bertarelli recommends letting a drop of the liquid containing the parasites dry on a slide, treating for 5 minutes with absolute alcohol very lightly tinted with eosin, washing with a mixture of equal parts of alcohol and xylol, then with xylol, and mounting in balsam.

B. Spread the preparation carefully on the slide and, before it is dry, fix for 10 minutes in an acetic-perchloride mixture (Schaudinn).

| | | |
|---|---|----------|
| Saturated aqueous solution of perchloride of mercury, | - | 100 c.c. |
| Absolute alcohol, | - | 50 " |
| Glacial acetic acid, | - | 5 drops. |

Wash for 10 minutes in alcohol containing a little iodine, then in 70 per cent. alcohol for 30–40 minutes, and stain with Heidenhain's or Grenacher's hæmatoxylin or with hæmatein and eosin.

C. Fix for 10 minutes in Flemming's solution, wash in water, then in alcohol, and stain with gentian-violet or safranin.

D. To make out details of structure fix in Schaudinn's solution (**B**, *ante*) or in alcohol and stain by one of the Romanowsky-Giemsa methods or with Laveran's or Marino's stain.

Sections.—To prepare sections of the intestine or of the wall of an abscess proceed by one or other of the following methods:

A. Fix in Schaudinn's solution (**B**, *ante*) and stain with hæmatein and eosin. The amœbæ are bright pink, the nuclei, violet.

B. Fix as in **A** and stain with Heidenhain's iron hæmatoxylin. The protoplasm of the parasite is hardly stained at all and the nucleus is outlined by a blue-black line.

C. Mallory and Wright's method.—Fix in alcohol. Stain for 5 minutes in a saturated aqueous solution of thionin: differentiate in a 1 per cent. solution of oxalic acid for 30–60 seconds, watching the preparation under the microscope and stopping the decolorization as soon as the nucleus assumes a violet tint: wash: dry: mount.

The protoplasm is streaked with blue and the nucleus is red or violet.

D. Borrel's method.—(vide *Coccidia*, Chap. LVII.)

Cultivation.

It has not yet been definitely established that cultures of the *Amœba histolytica* have been grown. Lesage, who has obtained cultures with which he has caused dysentery in young cats, is of opinion that these cultures owe their pathogenic properties not to the amœbæ which have multiplied and are probably saprophytic species, but to the *Amœba histolytica*, which has not multiplied but has retained its vitality. In any case cultures of intestinal amœbæ can only be obtained by growing them symbiotically with bacteria

and it would seem that they require living bacteria for food (Frosch, Mouton, Musgrave and Clegg, and others). The medium should be either a very feebly nutritive agar prepared with agar which has been washed for a long time (Lesage) or a similar medium containing a very small quantity (0.03–0.05 per cent.) of meat-extract and made alkaline.

Kartulis obtained cultures by sowing small amounts of stools in an infusion of straw, but the amœbæ only grew provided that the flasks were not plugged even with wool. These experiments however, as Schubert pointed out, are valueless as evidence that the amœba can be cultivated outside the body because the amœbæ found in the straw infusion were simply impurities from the dust in the air.

Musgrave and Clegg isolated intestinal amœbæ by sowing stools on agar plates previously sown with bacteria, for preference bacteria isolated from the intestine of the patient. These amœbæ, which Musgrave and Clegg found in water, in soil and on vegetables in the neighbourhood of Marseilles, would appear to be saprophytic species. Musgrave and Clegg are of opinion that all intestinal amœbæ may become pathogenic.

FIG. 354.—*Amœba histolytica* in recent stools. The figures represent the different forms assumed by the parasite when observed every 15 seconds. The endosarc contains a nucleus and three ingested red cells. (After Jürgens.)

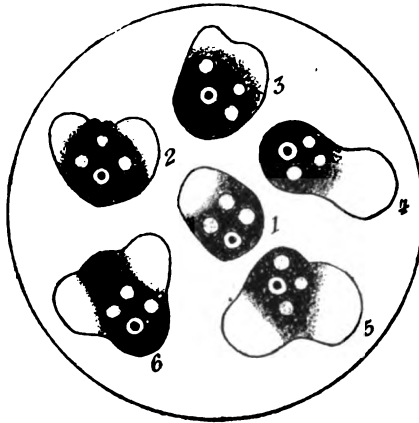

Lesage obtained cultures of amœbæ from 7 out of 30 cases of tropical dysentery. He sowed a little of the intestinal mucus either fresh or after it had been dried (encysted amœbæ) on the surface of agar plates. After incubating for a few days at 18°–25° C. small amœbæ were found at the points where the material was sown and were transferred to a fresh agar plate in such a manner as to be a little distance away from a colony of a paracolon bacillus. Sub-cultures were again made as soon as the amœbæ reached the colony of bacteria and after sub-cultivating in this fashion several times a mixed culture of amœbæ and paracolon bacilli was obtained. Cultures obtained in this way are very long-lived: Lesage kept his amœbæ in culture for 2 years and sub-cultured them 66 times; the amœba lives from 4–5 months in one culture while the cyst retains its vitality for at least 6–8 months.

More recently Lesage has found that his cultures were merely cultures of saprophytic amœbæ and this would also appear to be the case with the cultures he obtained by sowing dysenteric stools on leucocytes of guinea-pigs, rabbits, cats and man.

Experimental infection.

It is now established that the introduction of the *Amœba histolytica* into the alimentary canal of man, monkeys and young cats reproduces the lesions characteristic of dysentery.

Many of the early experiments, carried out before the amœba of dysentery was identified and when the fact that there were several forms of dysentery was unrecognized, only gave conflicting results.

Lösch injected recently-passed dysentery stools into the alimentary canals of four dogs: after the lapse of a week amœbæ were found in the excreta of one only of the animals: this animal remained in apparently good health, but when it was killed on the eighteenth day the rectal mucous membrane was found to be inflamed and ulcerated in places and the amœbæ had multiplied at the site of the ulcers.

Kovacz produced a blood-stained diarrhoea in a cat by inoculating it in the rectum with dysenteric stools.—Kartulis obtained a similar result with one of his straw infusion cultures.—Zancarol produced dysentery in a cat by inoculating stools containing amœbæ into the rectum; but he obtained the same result with pus from an abscess of the liver which only contained Streptococci and also with pure cultures of Streptococci.

Moreover, cats often suffer from an ulcerative colitis resembling dysentery (Gasser) and dogs are liable to a similar disease. The author saw several dogs in Tunis affected with this form of colitis and failed to find amœbæ in the dejecta. In the cat rectal injection of irritant substances and especially of sterilized soil produces ulceration of the colon.

Kartulis infected a cat with amœbic dysentery by inoculating it *per rectum* with stools from a patient suffering from amœbic dysentery. The same result can be obtained by inoculating pus from an abscess of the liver containing amœbæ in pure culture (Kartulis, Krause) and by operating in a similar manner an amœbic dysentery which is almost always fatal can be set up in young dogs (Hlava, Kartulis, F. Harris).

Lesage inoculated 0.5 c.c. of recent dysenteric stools or pus freshly taken from an abscess of the liver and containing living amœbæ into the rectum of young cats. A certain proportion of the animals suffered from symptoms of amœbic dysentery with blood-stained mucus in the stools and died in about 12 days or a fortnight. *Post mortem*, lesions characteristic of dysentery were found (thickening, ulceration and necrosis of the mucous membrane of the large intestine). The parasites may enter the blood-stream.

Young cats can also be infected by feeding them (or by means of an œsophageal catheter) with minced meat mixed with infected stools: to produce infection the stools must contain encysted amœbæ (desiccated stools or stools which have been kept for a few hours in a moist chamber).

Lesage has also infected young cats with his cultures of amœbæ (*vide ante*).

Musgrave and Clegg by feeding monkeys (*Macacus cynomolgus* and *M. philippinensis*) with cultures of amœbæ, or by introducing the cultures into their stomachs, set up a typical dysentery with hæmorrhagic catarrh and occasionally small ulcers of the colon.—A man who had swallowed three gelatin capsules containing a three-week-old culture of an intestinal amœba together with an harmless bacillus suffered at first from diarrhoea with amœbæ in the stools (twelfth day) and later from tenesmus and blood-stained stools (twentieth day).

Agglutination.—The blood of persons affected with amœbic dysentery does not agglutinate the bacillus of Shiga.

CHAPTER LVI.

Section I.—The Microsporidia.

1. *Nosema bombycis*, p. 752. 2. *Nosema apis*, p. 753.

Section II.—The Myxosporidia, p. 754.

Section III.—The Sarcosporidia, p. 756.

Section IV.—The Haplosporidia, p. 759.

SECTION I.—THE MICROSPORIDIA.

No Microsporidium is known to infect man but one species, *Nosema bombycis*, is the cause of the silkworm disease known as pébrine and another species, *Nosema apis*, is the cause of Microsporidiosis of bees—the “Isle of Wight disease.”

1. *Nosema bombycis*.

Synonyms.—*Microsporidium bombycis*: [*Glugea bombycis*].

Cornalia was the first to observe the presence of bright oval corpuscles in silkworms affected with pébrine. These corpuscles commonly described as the *corpuscles of Cornalia* and which have obtained so considerable a notoriety since the investigations of Pasteur and Balbiani represent a stage in the life history of the parasite which is the cause of the disease.

The spore of *Nosema bombycis* is a small oval or pyriform-shaped parasite measuring $4 \times 2\mu$ surrounded by a spore-membrane and containing at one end a single polar capsule in which is hidden a spirally-twisted filament which can only with difficulty be demonstrated (Thélohan).

For the purpose of studying the development of *Microsporidium bombycis* Balbiani suggests the following experiment:—Feed a number of young silkworms not more than a few mm. long on mulberry leaves which have been washed over with an emulsion made by rubbing up an infected silkworm moth with a little water. In a few days the silkworms will be infected and the spores will be scattered along the lumen of the alimentary canal. The spores make their way into the wall of the gut and give origin to small trophozoites of variable size elongated in the direction of the longitudinal muscular coat.

Life history.—[The development of *Nosema bombycis*¹ in the silkworm begins as small uninucleate amœbulæ which are in the first instance found free in the digestive tract and later in the lymph channels. The amœbulæ multiply by fission, wander all over the body (planonts) and penetrate cells where they grow, assume an oval or spherical form and become meronts or schizonts. The meronts multiply by binary or multiple fission until they have filled and exhausted the host cell. They do not however pass to other cells. The multiplication of the meronts may be very similar in appearance to yeast cells and give rise to chains of cells. When the host cell is used up the meronts do not multiply further but produce a final generation of uninucleate cells which as sporonts give rise to a single spore.

[¹ Vide Minchin, E. A. *An Introduction to the Study of the Protozoa*. London, 1912.]

[The nucleus of the sporont (sporoblast) buds off three small nuclei, two of which form the sporocyst and the third is concerned with the polar capsule. The principal nucleus remains as the nucleus of the amœbula. The protoplasm probably also divides. The sporocyst when formed is a tough capsule which though produced by two cells does not show any indication of its two-fold origin. The spore is egg-shaped the anterior end being the narrower. The single polar capsule is of relatively large size and contains a very long filament. The amœbula occupies the middle of the spore and appears to encircle the axial polar capsule. The amœbula has at first a single nucleus which subsequently divides into two then into four.

[When the spore germinates in the intestine of a new host the polar filament is extruded and the amœbula escapes by the pore at the anterior end. The amœbula emerges from the spore with two nuclei leaving the other two in the sporocyst. The two nuclei fuse to form a synkaryon and the now uninucleate amœbula initiates the generation of planonts (Stempel).]

[Hereditary infection is effected by the penetration of the parasite into the ovary and the formation of spores within the ovum itself. Hence not only may the silkworm be infected by ingesting spores of the parasite but the newly-hatched silkworms may already be infected. This transmission of infection through the egg is with the possible exception of the parasite of Texas fever unique among the Sporozoa.]

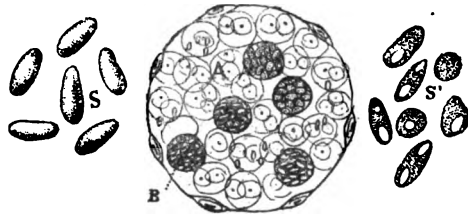

FIG. 355.—*Nosema bombycis*. B, masses of Microsporidia in a follicle of the testis of a silkworm: S, mature spores: S', immature spores. (After Balbiani.)

The detection of the parasites.—The *Microsporidia* are highly resistant to the action of chemical reagents, and can be best seen in the fresh state, unstained, with an high power dry objective. They may be stained by Vlacovich's method: treat with a 32 per cent. solution of potash for 48 hours, then with Gram's solution, and examine in a drop of glacial acetic acid: the parasites are stained violet.

2. *Nosema apis*.

[An epizootic disease of bees¹ which on account of the ravages it has caused during the past few years among the bees in the Isle of Wight has popularly become known as the Isle of Wight disease has been shown by Fantham and Porter to be due a microsporidian parasite of the genus *Nosema*—*Nosema apis*. The disease however is widely spread and is more suitably described as Microsporidiosis of bees.

[The symptoms of bee disease which however seem to be subject to considerable variation are thus described by Virgil: ²

“Si vero, quoniam casus apibus quoque nostros
 Vita tulit, tristi languebunt corpora morbo—
 Quod jam non dubiis poteris cognoscere signis:
 Continuo est ægris alius color; horrida voltum
 Deformat macies; tum corpora luce carentum
 Exportant tectis et tristia funera ducunt;

[¹ See Supplement No. 8 to *The Journal of the Board of Agriculture*, Vol. xix. No. 2. May 1912.]

[² P. Vergili Maronis, *Georgicon*, Liber Quartus.]

Aut illae pedibus connexæ ad limina pendent,
Aut intus clausis cunctantur in aedibus, omnes
Ignavaeque fame et contracto frigore pigrae."

[Infection takes place by the contaminative method and may be transmitted through the agency of infected foods or of living infected bees. Foraging bees infected by ingesting food containing the spore and "parasite-carriers" are the most important agents of infection (Graham Smith and Bullamore).

[The main alimentary tract of the bee, particularly the chyle stomach and intestine, are the chief parts infected. The gut diverticula appear to be free from parasites, but as the *Nosema* may be found in the hæmocœlic fluid, the parasite may occasionally invade other organs (Fantham and Porter). It is at present doubtful whether hereditary infection occurs as is the case with *Nosema bombycis* in silkworms (*vide supra*).

[The spores of *Nosema apis* occur as oval, highly refractile bodies 2-4 μ in diameter and 4-6 μ in length. Frequently they are found lying between the cells of the gut wall and in the earlier stages these cells are distended with the parasites.

[**Technique.**—For microscopical examination small portions from different parts of the alimentary canal should be teased out in a drop of water and mounted under a cover-glass. As fixatives, osmic acid vapour followed by absolute alcohol, or acetic-perchloride solution may be used. The most useful stains are Giemsa's solution or hæmatoxylin. Sections give very disappointing results. For the extrusion of the polar filament treatment with iodine water or dilute acetic acid are recommended.

[**Life history.**—Spores of the parasite, swallowed with food or drink by the bee, give rise each to an amoeboid parasite or planont which either enters an epithelial cell of the gut or reaches the hæmocœle. In either case it becomes rounded, feeds, grows and then commences to multiply. The meront, as the parasite is described at this stage, divides by binary fission producing clusters or chains, each daughter meront being ultimately uninucleate.

[The multiplicative stage is followed by the second or propagative stage—sporogony. The full grown meront becomes the sporont or pansporoblast which undergoes complicated nuclear changes whereby five nuclei are ultimately produced. The sporoblast forms two vacuoles, an anterior one called the polar capsule and a posterior vacuole in which the polar filament is coiled. The secretion of the sporocyst converts the sporoblast into the spore (Fantham).]

Among other species of *Microsporidia* the following may be mentioned:—*Nosema ovoideum*, a parasite of *Motella tricirrata* and of *Cepola rubescens*; *Nosema bryzoides*, found in certain *Bryozoa*. Lutz and Splendore have described several species of *Microsporidia* in the *Lepidoptera*, in different insects and in a *Cyprinodont* fish. Simond has found a *Nosema* in a mosquito (*Stegomyia fasciata*): this parasite seems to be identical with *Myxococcidium stegomyiæ*, erroneously described by Beyer and by Parker and Pothier as the cause of yellow fever.

SECTION II.—THE MYXOSPORIDIA.

The *Myxosporidia* are found as parasites in fish, reptiles, arthropods, etc. They inhabit the skin, gills and internal organs: the nervous system appears to be the only part of the body never infected.

Jaboulay is of opinion that cancer in man is due to a *Myxosporidium*, the source of infection being salads, molluscs, fish or unsuitable drinking water.

Detection of *Myxosporidia* in fish.—The parasites should be looked for in the small prominent pustules which develop on the integuments, in the blood cysts which form on all the branches of the splenic artery (in tench), in the

cysts on the gill-slits, urinary bladder and swim-bladder, in the spleen, liver, etc.

If a small cyst—2–6 mm. long—be transferred to a slide and examined under the microscope it will appear in the fresh unstained condition to consist of an enveloping membrane and its contents. The envelope is tough, thick, and amorphous, while the contents consist of a more or less liquid material (stained with hæmatoïdin in arterial cysts) containing various granules, as well as parasites in different stages of development.

Sections of the internal organs (liver, kidney, etc.) should be fixed in osmic acid or perchloride of mercury and stained with safranin or gentian-violet and eosin (Wosielewski): carbol-thionin is equally useful.

Morphology.—The parasites are often rounded and vary considerably in size (65–300 μ): their protoplasm is finely granular. When examined in fish urine they exhibit very slow movements; these are not apparent when the parasites are examined in water.

In the parasites as just described there appear at a given moment small rounded structures containing one or two nuclei; these constitute the *primitive spheres* in which the *spores* are formed (Laveran). Each sphere gives rise to two spores and some fatty granules which stain with osmic acid. The structure of the spores is complicated and varies in the different species; in size they vary from 8 to 36 μ . A spore consists of an enveloping membrane and its contents: the membrane of the envelope is formed of two transparent, homogeneous valves applied one to another like the two halves of a walnut-shell. At one of the poles of the spore there appear one to four vesicles or *polar capsules*, which stain with methylene blue, thionin or safranin. These polar capsules each elongate into a small canal and become attached to the wall of the spore at the pole, where a very fine opening communicating with the exterior is formed.

Each polar capsule contains a spirally-twisted filament which is very difficult to see under natural conditions, but if the preparation be treated with a drop of glycerin or potash solution the filaments suddenly unroll themselves and project from the spore; these filaments are occasionally very well developed and may be eight to ten times the length of the spore (fig. 357). Besides the polar capsules, the spore contains an homogeneous protoplasm and a centrally-situated nucleus which can be stained with safranin.

The spore constitutes the means by which the parasite is conveyed from

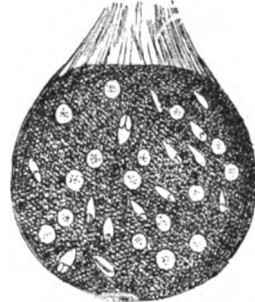

FIG. 356.—Myxosporidium of the tench. Cyst developed in the wall of the mesenteric artery and containing myxosporidia. (After Balbiani.)

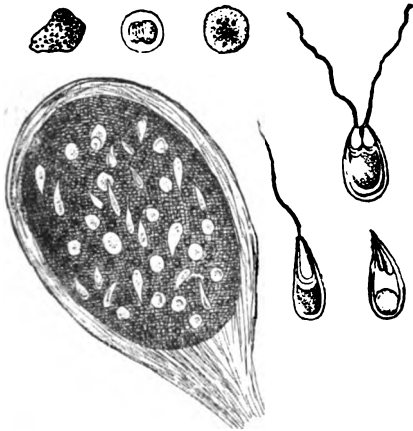

FIG. 357.—Myxosporidium of the tench. Malpighian corpuscle containing a Myxosporidium. Various forms of spores contained in the corpuscle: above, immature amoeboid spores; to the right, immature spores. (After Balbiani.)

one individual to another. Spore formation represents the sexual (*sporogonic*) method of reproduction.

According to Doflein and Laveran multiplication of the Myxosporidia within the host takes place by division into two (equal or unequal) parts (*schizogony*). The investigations of Thélohan and Hofer on the *Myxosporidia* of fish and those of Laveran on *Myxidium danilewskyi* (a parasite of *Cistudo europæa*) tend to prove that infection takes place *via* the alimentary canal.

Of the numerous *Myxosporidia* which have been described in cold-blooded vertebrates the following may be mentioned: *Myxidium danilewskyi*, studied by Laveran in a tortoise (*Cistudo europæa*): *M. lieberkühni*; *Myxobolus bütschli* (in fresh-water fish); *M. cerebralis*, described by Hofer as the probable cause of a disease of certain trout; *M. lintoni* (in *Cyprinodon variegatus*); *M. cyprini* which is the cause of "Pockenkrankheit" of carp (Tedeschi); *Leptotheca agilis* (of salt-water fish); *Ceratomyxa appendiculata* (a parasite of *Lophius piscatorius*); *C. linospora*, *C. inæqualis* (of salt-water fish).

SECTION III.—THE SARCOSPORIDIA.

The *Sarcosporidia* are found as parasites in the muscles (striated and non-striated) and sometimes in the connective tissues of the mammalia (mice, rats, monkeys, pigs, cattle, horses, sheep) and birds.

These protozoa are very seldom found as human parasites. On two occasions *Sarcocystis tenella*, a very common parasite of the sheep, has been found in man and on each occasion by chance—once by Baraban and Saint Rémy in the vocal cords of an executed criminal and on the other occasion by Hoche in the muscles of a person who had died of tuberculosis. Kartulis found a sarcosporidium (*Sarcocystis immitis*) in the liver and muscles of a Soudanese. The parasites found by Hadden, Koch, Klebs and Evè in the kidney, and by Rosenberg in the muscle of the mitral valve of a woman, are [by some] considered to be other instances of sarcosporosis in man. Vuillemin thinks that systematic investigation would show *Sarcocystis tenella* to be a much more common parasite in man than is generally believed. A sarcosporidium which is parasitic in elks, caribous and deer is also said to be capable of infecting man (H. Brooks).



FIG. 358.—
Spore of a Sarcosporidium. (After Laveran and Mesnil. c, capsule; n, nucleus surrounded by granules.)

The means by which the Sarcosporidia are transmitted from one host to another are still very imperfectly understood but it is probable that infection takes place through the alimentary canal and may be the result of the ingestion of infected meat. Grey mice have been infected by feeding them on the muscles of other mice infected with sarcosporidia (Smith, Koch) and in these cases there was a minimum incubation period of 45 days before the parasite appeared in the tissues. Negri has infected guinea-pigs by feeding them with *Sarcocystis muris*. [Kartulis' case (*ante*) affords some support to the view that the alimentary canal is the channel of infection, because sarcosporidia were found in small numbers in that situation and they may quite conceivably have passed through the intestinal wall into the branches of the portal vein and so reached the liver (Guiart).]

Morphology.—According to Laveran and Mesnil the sarcosporidia should all be grouped in one genus (*Sarcocystis*) and in their view there is no sufficient ground for dividing them, as was proposed by Blanchard, into two families according as to whether they are found in the muscles [*Miescheria*] or connective tissues [*Balbiana*].

These two families were until recently recognized as comprising three genera which were differentiated by the thickness of the enveloping membrane or cuticle of the parasite. The genus *Miescheria* included intra-muscular species surrounded

by a thin membrane and the genus *Sarcocystis* the intra-muscular species which had a thick capsule penetrated by fine canaliculi. The genus *Balbiania* comprised the parasites found in the connective tissues and these had a thin cuticle. These so-called genera are, however, merely stages in the life history of the same parasite (Laveran and Mesnil).

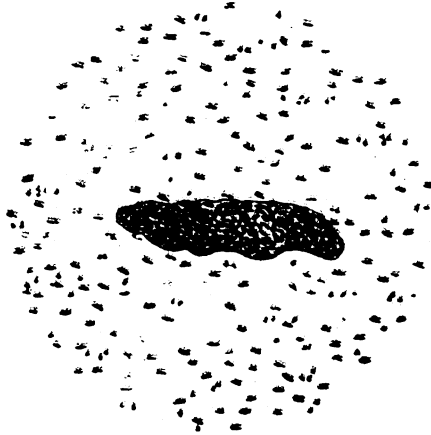

FIG. 359.—Section through a muscle infected with *Sarcocystis tenella*.

Sarcosporidia can be most conveniently studied in the muscles of sheep and pigs in which they are sometimes found in enormous numbers—chiefly in the œsophagus, tongue, psoas and diaphragm.

If a portion of an infected muscle be examined under the microscope the parasite will appear as a whitish fusiform or spindle-shaped body measuring 1–5 mm. long lodged in the muscular fibre, its long axis running in the long axis of the muscle. These elongated spindles represent Miescher's or Rainey's tubes [so called after Miescher, who discovered sarcosporidia in the muscles of mice and after Rainey, who found similar parasites some years later in pigs' muscles]. The membrane enclosing these tubes is at first a fine, structureless cuticle but before long it thickens and becomes channelled by numerous very fine canaliculi (arranged for the most part transversely to the long axis of the parasite, but towards the extremities directed obliquely and at the tip lying in the direction of the long axis). The extreme tenuity of the membrane (ca. 1μ) can be demonstrated in sections of sarcosporidia (Laveran and Mesnil).

As the parasite grows it gradually distends and destroys the muscular fibre in which it is parasitic, until finally it is surrounded merely by the sarcolemma and sarcoplasm and drops out in most cases into the connective tissue. This then is the way in which the intra-muscular parasite (*Sarcocystis*) becomes the connective tissue parasite (*Balbiania*).

While the parasite is growing at the expense of the muscular fibre in which it has taken up its abode the nucleus divides into a number of secondary nuclei around which the protoplasm segregates, thus forming a number of *sporoblasts* which in turn segment, giving origin to the so-called *falciform corpuscles* or *sporozoites*.

On leaving the muscle and passing into the connective tissue the spindle-shaped parasite is surrounded by a second capsule derived from the muscular fibre (Laveran and Mesnil). It now changes its shape, becomes rounded, and at the same time increases in size (up to 1 cm.) by an increase in the number of sporozoites, while its cuticle or membrane is so distended as to

be again thin and structureless. The parasite then bursts its capsules, the sporozoites are set free and a further infection of the host takes place.

Infection of new hosts appears to be effected by the curved, non-motile, sausage-shaped sporozoites described by Laveran and Mesnil. These sporozoites have rounded ends, of which one is larger than the other and contains a large nucleus surrounded by chromatin granules; the other end is somewhat more pointed [and contains a striated body which may be the analogue of the polar capsule of the Myxosporidia (Guiart)]. The sporozoites are very fragile and can be readily dissociated by keeping them in a moist chamber or by treating them with very dilute acids or alkalis. They probably do not represent the form which the parasite assumes outside the body (Laveran and Mesnil).

Principal species of *Sarcocystis* :

Sarcocystis muris, found in mice and rats.

Sarcocystis miescheriana, a parasite of pigs, but does not seem to have been found in man.

Sarcocystis tenella, a common parasite of sheep and goats: this parasite has been found in man (*ante*). It would appear to be related to *Balbiania gigantea*, found in the oesophagus of sheep, and apparently a giant form of *S. tenella*.

Sarcocystis immitis, found by Kartulis in multiple abscesses of the liver and muscles of a Soudanese.

Balbiania mucosa, found by Blanchard in the kangaroo and in the connective tissues of a Soudanese, and *Balbiania siamensis*, a parasite of Siamese buffaloes, are very closely allied to *B. gigantea* and are therefore included in the genus *Sarcocystis*.

Sarcocystis blanchardi, a parasite of European and Javanese buffaloes.

Toxin.—Pfeiffer found that an aqueous extract of *Sarcosporidia* inoculated beneath the skin of a rabbit led to a fall of temperature, diarrhoea, and ultimately to the death of the animal. Laveran and Mesnil repeated Pfeiffer's experiments and proved the existence in the *Sarcosporidium* of sheep (*S. tenella*) of a toxin to which they have given the name *sarcocystine*. Laveran and Mesnil prepared both aqueous and glycerin extracts of *Sarcosporidia*; the aqueous extract was found to lose its toxicity rapidly, so that in 6 days it was already much less toxic than when prepared; the glycerin extract, on the other hand, which is quite as toxic as the aqueous extract, keeps much better and preserves its toxicity unaltered for about a month.

Preparation of the toxin.—Enucleate a number of *Sarcosporidia* from the oesophagus of a sheep and after weighing them, crush them up in a mortar with sterile sand and a known volume of water or glycerin (according as to whether an aqueous or glycerin extract is to be prepared): filter the aqueous extract through a porcelain bougie and the glycerin extract through paper.

If *Sarcosporidia* be opened and inserted beneath the skin they give rise to the same symptoms as the extracts, but if the cuticle be intact symptoms of intoxication are delayed. Laveran and Mesnil also prepared a highly toxic dry extract.

Preparation of dry extract.—A number of *Sarcosporidia* are dried in a desiccator over sulphuric acid and powdered; the white powder constitutes the extract and must be stored in small sealed tubes. One cg. of the dry extract is equivalent to 5 or 6 cg. of fresh *Sarcosporidia*.

Action on the lower animals.—While very toxic for rabbits *Sarcocystine* is almost without effect on other animals.

On rabbits.—A weight of extract equivalent to 1 mg. of fresh *Sarcosporidia* inoculated beneath the skin of a rabbit weighing 1 kg. leads in about 2 or 3 hours to an attack of diarrhoea accompanied by a fall of temperature to below normal: the cholera-like symptoms become rapidly more marked, convulsions set in and death occurs in about 5–10 hours. Smaller doses of toxin give rise to a slight oedema at the site of inoculation, rise of temperature, and wasting; diarrhoea is a late symptom

and is accompanied by a slight fall of temperature below normal; death occasionally takes place about the twentieth day. *Post mortem* examination reveals no lesion of importance.

Inoculation of the aqueous extract into the peritoneal cavity has the same effect as sub-cutaneous inoculation. After intra-venous inoculation symptoms develop rather more rapidly. Inoculation of large doses into the brain gives rise to the same symptoms as the inoculation of similar doses beneath the skin. Feeding experiments and the injection of the aqueous extract into the small intestine do not prove fatal.

Mesnil extracted a similar sarcocystine from *Sarcosporidia* found in the oesophagus of an Hungarian buffalo. An emulsion in normal saline solution of *Sarcosporidia* from a Llama inoculated into rabbits gave rise to symptoms referable to the nervous system—ascending paralysis, sub-normal temperature, etc.; there was no diarrhoea (Rievel and Behrens).

Properties of sarcocystine.—The properties of sarcocystine resemble those of certain bacterial toxins. The aqueous extract loses its toxicity when heated at 100° C. for 5 minutes or at 85° C. for 20 minutes. The glycerin extract is more resistant to the action of heat; after heating at 85° C. for 30 minutes it will still prove fatal to rabbits if inoculated in large doses.

By mixing an aqueous extract of sarcocystine with Gram's solution or a 1 in 12 solution of hypochlorite of sodium its toxicity is lowered.

The toxicity of the extract is not diminished by triturating it with rabbits' brain or muscles, so that the toxin is not fixed by these tissues.

SECTION IV.—THE HAPLOSPORIDIA.

Caullery and Mesnil include under this heading certain Protozoa which, though related to the *Sarcosporidia* and the *Microsporidia*, are characterized by the absence of polar capsules in the sporozoites.

O'Kinealy described a vascular tumour of the nose in a man in Calcutta which was due to an *Haplosporidium* (*Rhinosporidium kinealyi*). This tumour contained encysted parasites of a spherical shape.

The young parasites have a granular protoplasm surrounded by an hyaline membrane and containing several small nuclei: later, the enveloping membrane thickens and the protoplasm segments around the nuclei to form sporoblasts and these in turn divide and form sporozoites which, being set free by rupture of the cyst, give rise to new parasites.

CHAPTER LVII.

THE COCCIDIIDEA.

Section I.—The genus *Coccidium*, p. 760.

1. *Coccidium cuniculi*, p. 760.
Morphology, p. 761. Life history, p. 762.
2. Other principal species of *Coccidia*, p. 764.

Section II.—The genus *Klossia*, p. 765.

Section III.—Parasites in tumours, p. 766.

1. *Coccidia*, p. 766.
2. *Micrococcus neoformans*, p. 769.

[THE Coccidiidea are Sporozoa belonging to the sub-division Telosporidia—parasites “in which the reproductive phase of the life-cycle is distinct from, and follows after, the trophic phase” (Minchin).]

The *Coccidia* are found as intra-cellular parasites both in the Vertebrata and in the Invertebrata.¹

The *Coccidia* are small, oval or spherical, nucleated amœboid bodies with granular protoplasm. Reproduction takes place both asexually (*schizogony*) and sexually (*sporogony*). The investigations of Léger and of Mesnil have shewn that the *Coccidia* should be classified with the Hæmatozoa (Chap. LVIII.).

SECTION I.—THE GENUS COCCIDIUM.

Coccidium cuniculi.

(*Coccidium oviforme*.)

Whitish or yellowish masses resembling small softened abscesses and containing oval-shaped structures similar to the eggs of Nematodes are frequently to be found lodged in the hepatic canaliculi or parenchyma of the livers of rabbits: these masses are in reality *Coccidia*. A *Coccidium* consists of a refractile enveloping membrane, granular protoplasm, nucleus and nucleolus.

The infection in the rabbit often resolves spontaneously: the *Coccidia* are expelled as *oocysts* (*vide infra*), and on *post mortem* examination nothing more than cicatricial scars on the surface or in the substance of the liver are left as an indication of a previous infection. In young rabbits *Coccidia* may multiply very rapidly (Pfeiffer), in which case the infection is scattered throughout the liver; the biliary canals are dilated and the connective tissue hypertrophied, compressing the blood-vessels

¹ Speaking generally, the evolution of the *Coccidia* takes place within the cells of the animal infected. Laveran and Mesnil have, however, described a *Coccidium* in a tortoise in which the development was entirely extra-cellular: this may perhaps also be the case with *C. bigeminum* (*vide infra*).

and leading to atrophy of the liver substance. The internal organs are wasted and discoloured, the blood is pale-coloured and watery, and the animal eventually dies.

The Coccidium of the rabbit may infect man. Gubler has seen as many as twenty purulent cysts in the human liver, of the size of a walnut or hen's egg, in which the parasites were actively multiplying. In a case recorded by Silcocks the liver, spleen and intestines were infected, the parasite being found in all the lesions.

The Coccidium described as *Coccidium perforans* or *C. hominis*, and found in the epithelial cells of the intestine of the rabbit and man, has now been shown to be the same species as *C. cuniculi* (Rivolta, Metzner). This parasite has been found by chance during *post mortem* examinations and during examinations of the stools for other parasites; in most cases it did not appear to be responsible for any special symptoms, but Railliet and Lucet have found it in two cases associated with symptoms of chronic diarrhoea.

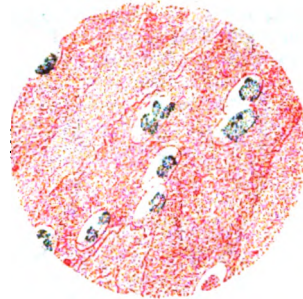

FIG. 360.—Coccidiosis in the rabbit. Scraping from the liver stained with eosin: the parasites are unstained.

Morphology.

If the contents of one of the cysts be examined under the microscope in a drop of water or normal saline solution the parasite can be seen quite distinctly. The Coccidia stain badly, so that if a drop of an aqueous solution of eosin be added to the above preparation the parasites stand out conspicuously as unstained objects on a pink background.

For studying the structure of Coccidia, Pianese fixes small pieces of the liver for 36 hours in a mixture consisting of:

| | | | |
|---|---|---|---------|
| 10 per cent. aqueous solution of cobalt chloride, | - | - | 20 c.c. |
| 2 per cent. aqueous solution of chromic acid, | - | - | 5 " |
| Formic acid, | - | - | 1 drop. |

Bertarelli advises fixing in a saturated aqueous solution of perchloride of mercury, staining for 24-48 hours in a dilute solution of Grenacher's hæmatoxylin (1 c.c. hæmatoxylin in 200 c.c. of water) and differentiating in acetic-alcohol.

Borrel gives a method for fixing and staining which is particularly useful for studying sporozoa in sections:—

Place very small pieces of the tissue in the following mixture for 24 hours in the ice chest:

| | | | | | | |
|--------------------|---|---|---|---|---|----------|
| Osmic acid, | - | - | - | - | - | 2 grams. |
| Platinum chloride, | - | - | - | - | - | 2 " |
| Chromic acid, | - | - | - | - | - | 3 " |
| Acetic acid, | - | - | - | - | - | 20 " |
| Distilled water, | - | - | - | - | - | 350 " |

Wash in a large quantity of water.

Embed in paraffin.

Stain thin sections for 1 hour in the cold in a saturated aqueous solution of Magenta red and differentiate for 5-10 minutes in the following solution:

| | | | |
|--|---|---|------------|
| Saturated aqueous solution of picric acid, | - | - | 1 volume. |
| Saturated aqueous solution of indigo-carmin, | - | - | 2 volumes. |

Wash rapidly. Decolourize in absolute alcohol, then in clove oil, and leave the section in clove oil for some little time. Mount in balsam. The nuclei will be stained red, the protoplasm blue-green, and hæmoglobin yellow or yellowish green.

Coccidium cuniculi is found in the epithelial cells lining the bile ducts. In these cells the cysts which are oval in shape measure about 40µ long x 20µ broad. They are filled with granular protoplasm which soon retracts from the wall and forms a separate sphere with a centrally placed nucleus: this

represents the *oocyst* stage—the last stage in the life history of the parasite in the animal tissues (fig. 361).

The oocysts then pass into the intestine and are eventually excreted: outside the body of the host they undergo a metamorphosis which renders them capable of setting up fresh infections in other animals (the disease is not directly contagious, or *miasmatic* as older writers would have termed it).

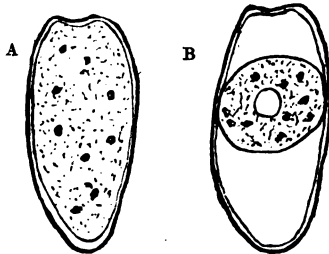

FIG. 361.—*Coccidium cuniculi*. Encysted adult forms. (After Blanchard.)

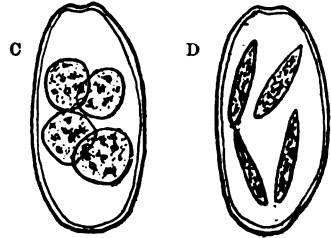

FIG. 362.—*Coccidium cuniculi*. Extra-cellular life history. C, formation of sporoblasts; D, transformation of sporoblasts into sporocysts. (After Blanchard.)

Life history.

I. Outside the animal body.

If a number of oocysts be placed in a drop of sterile water¹ in a Koch's cell and kept at a temperature of 15°–18° C. their contents will be seen in the course of 2 or 3 days to divide into two, and later, into four small spheres or *sporoblasts* (fig. 362). Each sporoblast then elongates and forms a *sporocyst* or *cytospore*, each of which in turn divides into two nucleated *falciform corpuscles*, *crescent bodies* or *sporozoites*, and a granular residuum which is not utilized (fig. 363).

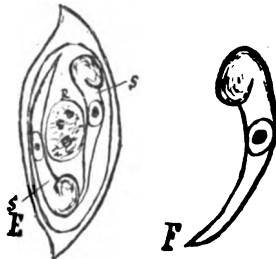

FIG. 363.—*Coccidium cuniculi*. E, an isolated sporocyst; s, s, sporozoites; r, residuum; F, an isolated sporozoite. (After Balbiani.)

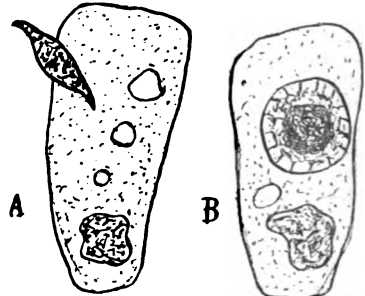

FIG. 364.—*Coccidium cuniculi*. A, sporozoite penetrating an epithelial cell; B, formation of the schizont.

II. Infection of the host.

The cyst containing the sporocysts is highly resistant to external influences and retains its vitality for a long time. When a rabbit swallows such a cyst the capsule is digested and the sporocysts are set free, and these in turn open and discharge the sporozoites. The sporozoites are actively motile and so are able to pass into the

¹ The following method is recommended by Léger and by Laveran for studying the extra-corporeal development of coccidia: Lay the material containing the coccidia on small pieces of charcoal and place the charcoal in watch-glasses containing a few drops of carbolized water (to prevent the growth of moulds and bacteria) and keep the preparation in a moist chamber.

biliary passages. On coming in contact with an epithelial cell the sporozoite by its pointed anterior end penetrates and passes entirely into the cell, reaches the centre of the cell-protoplasm (between the nucleus and the free surface), loses its motility and soon assumes a new appearance, the *schizont* (fig. 364), which grows at the expense of the cell in which it is living and multiplies by asexual division (*schizogony*).

III. In the body of the host.

A. Schizogony (Asexual reproduction).—The *schizont*, which has no enveloping membrane, grows and assumes a spherical form, while its protoplasm becomes hollowed out by large alveoli filled with a clear fluid. The nucleus soon divides into a large number of daughter nuclei which pass towards the periphery: the protoplasm divides into an equal number of segments and accumulates around the nuclei. Thus a number of claviform corpuscles are formed, arranged at first like the quarters of an orange but later becoming free and exhibiting movements similar to those of sporozoa. These represent the *merozoites* (fig. 365).



FIG. 365.—*Coccidium cuniculi*. Schizogony. A, multiplication of the nucleus; B, multiplication of the cell; C, fully-grown merozoites. (After Simond.)

At this moment the epithelial cell bursts and the merozoites are set free: some die in the intestine of the rabbit; others penetrate fresh epithelial cells, where one of two things may happen.

In some cases a merozoite entering a healthy cell loses its motility, becomes spherical, increases in size and forms a true schizont and at once begins to multiply in the manner already described. By *repeated schizogony* the parasite can multiply very quickly in the rabbit's tissues and this explains the very rapid manner in which infection sometimes spreads through the body.

In other cases a merozoite, after penetrating an epithelial cell, undergoes changes preparatory to a sexual mode of reproduction.

B. Sporogony (Sexual reproduction).—In this case some of the merozoites after entering a cell of the host are converted into female cells, *macrogametes*, others into male cells, *microgametes*.

1. Macrogametes.—The merozoite destined to become a macrogamete slowly increases in size, and provides itself with reserve material in the form of chromatin granules. The nucleus contains a karyosome which before long is expelled, and the macrogamete, elliptical in shape, exhibits contractile movements which generally result in its passing out of the cell-host; it then remains on the surface of the epithelium where it can be easily reached by the microgametes. The now mature macrogamete is spherical, non-motile, and has a sharply defined nucleus; the granulations pass to the periphery, fuse, and form an enveloping membrane pierced at one end by an orifice, the *micropyle*.

2. Microgametes.—The merozoite about to be transformed into a male cell has no enveloping membrane or granules of reserve material. It grows rapidly and soon becomes converted into the *microgametoblast* from which the microgametes will take origin. The nucleus, which has a large karyosome, divides into a number of daughter nuclei and these range themselves round the periphery of the organism and around each of them a mass of hyaline protoplasm collects. The daughter nuclei soon become flattened, elongated and comma-shaped. These are the *microgametes*; they continue to elongate and two *flagella* appear at their anterior extremity (the point of insertion of the flagella varying in different species): the microgametes are motile and, becoming free, leave the microgametoblast, which forms a residual body and is soon destroyed.

The microgamete bears a considerable resemblance to the spermatozoa of higher animals: it is very small ($6-8\mu$ long), actively motile, generally falciform, with an homogeneous refractile body, and is almost entirely composed of chromatin surrounded by a very thin layer of protoplasm (fig. 366).

3. Fertilization.—The mature macrogamete attracts the microgametes by chemio-tactic influences: a single microgamete penetrates the female cell at the micropyle and as soon as it has passed into the macrogamete the micropyle closes behind it. The male element reaches the nucleus of the macrogamete and fuses with it, forming



FIG. 366.—Free microgametes of *Echinospora*.
(After Léger.)

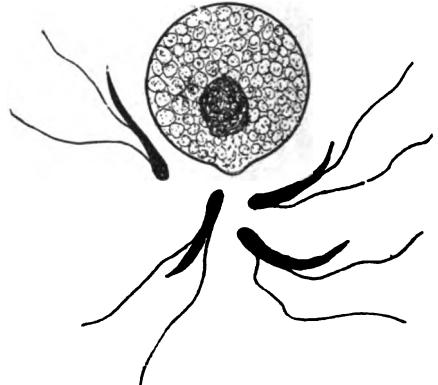

FIG. 367.—Fertilization in *Coccidium schubergi*.
(After Schaudinn.)

the oocyst, and fertilization is now completed.¹ The oocyst then leaves the body of its host, matures, and divides by *sporogony*, giving rise to *sporocysts*, which will infect new hosts (*vide ante*).²

Other principal species of coccidia.

The genus *Coccidium* comprises about forty species which are parasitic in the mammalia, birds, reptiles, batrachians, fish, myriapods and insects. The following species may be mentioned in addition to those already noticed:

Coccidium falciforme, a parasite of *Mus musculus*; *C. avium* (vel *C. tenellum*), a parasite infecting fowls, pheasants, etc.; *C. salamandræ*; *C. pfeifferi*, a parasite of doves; *C. jalinum*, observed by Perronçito, Dematteis and Borini in a case of chronic enteritis.

According to Wasiliewski, *C. bigeminum* (vel *Cystospermium villorum intestinalium canis*) which has its habitat in the villi of the intestine of dogs and cats, is probably the same parasite as that found by Kjellberg in Berlin in the intestinal villi of a man, and should be classified with the Diplospora, a genus closely related to the Coccidia and characterized by the fact that the oocyst produces two sporocysts each giving origin to four sporozoites.

The genus *Eimeria* (Schaudinn), in which Blanchard includes the parasite found by Künstler and Pitres in a case of pleurisy in man (*E. hominis*), should apparently be classed among the *Coccidia*.

Unclassified Coccidia.—Kartulis has recorded cases in which Coccidia were the cause of tumours in muscles. Lindermann found brownish-looking tubercles, 2-3 mm. in diameter, and containing coccidia, in the sigmoid valves of the aorta

¹ The fertilized cell is sometimes known as the *zygote*.

² In some species, the oocyst matures in the tissues of the infected host and may at once infect new hosts without passing through an extra-cellular stage. These coccidia are directly contagious (*C. truncatum* of the goose; *C. proprium* of the triton).

and in the mitral valve of a patient who had died of anasarca. Coccidia have also been found in the kidneys (Lindermann); in the skin (Milian, Cornil and Duret); and in the liver (Gubler, Virchow, etc.).

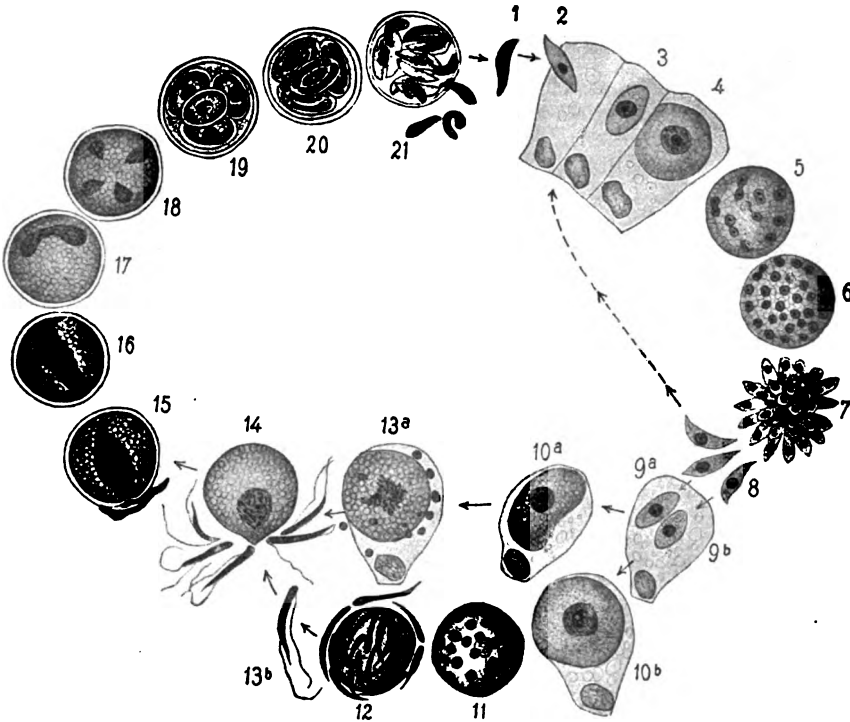

FIG. 368.—Life history of a Coccidium. (Scheme after Schaudinn.)

A. Schizogony.—1. A sporozoite free in the intestine of the host. 2. Penetration into an epithelial cell. 3, 4. Growth of sporozoite into trophozoite. 5, 6, 7. Stages in asexual multiplication. 8. Free merozoites.

B. Sporogony.—9a. Undifferentiated female cell. 10a. Macrogametocyte. 13a. Macrogamete. A single macrogamete only is formed from each female cell.—9b. Undifferentiated male cell. 10b. Microgametocyte. 11, 12. Formation of several microgametes from a single male cell. 13b. Microgamete.—14. Fertilization. 15, 16, 17. Zygote. 18, 19. Formation of spores. 20. Formation of sporozoites within the spores. 21. Sporozoites released in intestine of host. (From Mense's "Handbuch der Tropenkrankheiten.")

SECTION II.—THE GENUS KLOSSIA.

Klossia helicina is an excellent species for the study of the Coccidia and for this reason a short description of it is given here. The parasite lives and is almost always to be found in the tissues of *Helix hortensis*. Its life history has been described by Laveran.

Salomonson recommends the following technique for the study of *Klossia helicina* :—

Break the shell of an *Helix hortensis* as far as the second spiral near the orifice. On removing the shell debris, a part of the lung and the pericardium, through which the heart can be seen beating, will be exposed: and lying by the side of these structures the kidney, appearing as a fusiform greyish mass, will be seen. Take hold of the kidney with the forceps, cut off a small piece with scissors, lay it on a slide and cover with a cover-glass.

On examining the preparation under the microscope, in addition to normal epithelial cells a number of cells distended with *Klossia* will be seen (fig. 369).



FIG. 369.—*Klossia helicina*. Kidney cell of *Helix hortensis* containing three young *Klossia*: the cell nucleus is situated near the narrow end of the peduncle. (After Balbiani.)

The parasite passes through all the stages of its life history in the same cell: the nucleus of the infected cell is often considerably hypertrophied (up to 60 times its natural size), and later—when the coccidium has attained large dimensions—the nucleus degenerates and atrophies.

Within the oocyst several sporocysts are formed: each sporocyst gives rise to four sporozoites and a residuum. When the sporozoites are set free they infect other epithelial cells where they form schizonts, which pass through the ordinary processes of schizogony.

The following genera, which include no human parasite among their numerous species, may be mentioned: *Cyclospora*, *Barrouxia*, *Adelea*, *Legerella*.

SECTION III.—PARASITES IN TUMOURS.

1. Coccidia.

The discovery a few years ago of structures, which were said to bear a striking resemblance to the coccidia, in certain epithelial neoplasms seemed to afford a scientific basis for the parasitic theory of malignant new growths: and within a short space of time discoveries of protozoa in epithelial tumours were reported from all quarters.

The accounts of the numerous apparently successful investigations which were at once set on foot on receipt of these reports only serve to show the errors into which one may fall in interpreting observed appearances: the result is that these researches are discredited and that the majority of histologists have now discarded the theory of the coccidial origin of new growths.

Many observers have succeeded in inoculating malignant new growths from one animal into another of the same species and even into animals of different species, these experiments being especially successful when a mouse cancer is inoculated into other mice. But these inoculations result not in a true infection but merely in a graft of cancer cells, and the growth which follows a successful inoculation is in Jensen's words "a true culture of cancer cells." The more important of the appearances which have been described as parasites of new growths will be here briefly passed in review (*vide* also pp. 707, 735, 839).

I. Neisser, in 1888, affirmed the parasitic nature of *Molluscum contagiosum* or *Acne varioliforme*: and described certain peculiar oviform structures which he regarded as Coccidia. These structures however are merely cells undergoing hyaline degeneration.

In sections stained with Ranvier's picro-carminé it can be seen that the changes in the cells increase progressively from the centre to the surface of the growth. The nuclei distinctly visible in the deeper layers are less conspicuous in the parts nearer the surface: the section which is stained yellowish pink in the centre becomes more and more yellow as the periphery is approached: the cells themselves are more and more infiltrated with an hyaline substance which finally occupies the whole of the cell body including the nucleus: towards the centre the hyaline oval cells are packed closely one against another and are surrounded by a filamentous network containing granules of *eleidine*. No indication of the structures described and no oviform parasitic bodies can however be made out, and the only changes visible are the changes in the cells undergoing keratinization.

II. Darier, Malassez, and Wickham have described certain appearances in *psorospermosis follicularis* and in *Paget's disease of the nipple* which, being always situated within the neoplastic cells, they took to be encysted coccidia.

The structures described by these authors are not parasites, but cells of the epidermis derived from the Malpighian layer which after undergoing certain changes analogous to that of normal keratinization and becoming rolled up and cut off from

surrounding cells form cell-nests (Borrel, Fabre-Domeyne, Brault, Torök and others). The micro-chemical reactions of these bodies are those of keratinized cells: picrocarmine stains them bright yellow, osmic acid deep brown, etc.

III. Albarran described the occurrence of Coccidia in a new growth of the upper jaw. Albarran's "coccidia" were in some cases encysted, and in others not encysted; they were slightly rounded, having a more or less visible nucleus and were always situated outside the epithelial cells.

These forms never present the characteristic appearance of Coccidia and never show falciform bodies. "The different appearances presented by these cells, the accumulation of refractile bodies, the uniform staining of the whole mass by the same stain indicate, on the contrary, that they are cells undergoing disintegration preparatory to disappearing" (A. Brault).

IV. Many observers have described Coccidia in cancers. The various descriptions given by different authors do not agree among themselves and apply evidently to very different conditions. Soudakewitch, Foa, Ruffer, Walker, Thoma, and Savtchenko all ascribe the parasitic forms which they describe to the Coccidia. Savtchenko has, however, abandoned the idea that the appearances seen by him were due to an animal parasite and considers rather that they belong to the yeasts.

Soudakewitch's method.—In 110 cancers, Soudakewitch found certain appearances which he attributed to the presence of Coccidia. The technique employed in these researches was as follows:

1. **Fixation.**—Fix in a saturated aqueous solution of perchloride of mercury, Flemming's solution, or by immersion in a 1 per cent. solution of osmic acid for 48 hours followed by 3–5 days in Müller's fluid.

2. **Embed in celloidin.**

3. **Staining.** (a) *Of sections fixed in perchloride.*—Leave the sections in an aqueous solution of safranin for 1 or 2 days, then wash in alcohol slightly acidified with nitric acid, or in a weak aqueous solution of picric acid.

(b) *Of sections fixed in osmic acid.*—Stain with an old solution of Ranvier's hæmatoxylin.

4. **Microscopical appearance.**—Use an high power dry lens. In the cancer cells, small rounded spherical bodies will be seen displacing and compressing the nucleus: these bodies have an enveloping membrane, a finely granular protoplasm and a

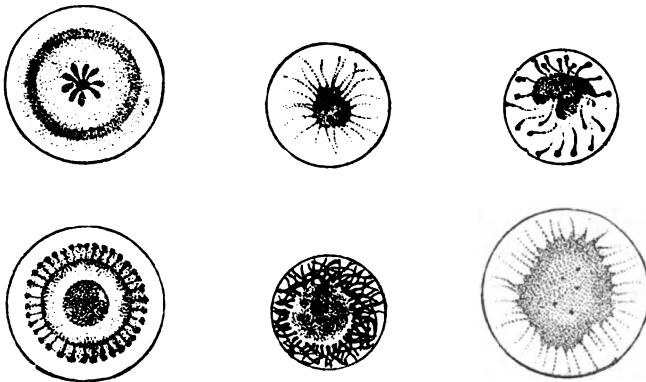

FIG. 370.—Parasites of cancer. (After Soudakewitch.)

nucleus. In size they may be as large as a leucocyte, and generally speaking there is only one so-called parasite in each cell, though there may be two, three, or even five. After staining with hæmatoxylin very diverse and complicated structures may be seen in the interior of the parasite, of which fig. 370 reproduced from Soudakewitch's drawings gives an idea.

Cells containing these structures are generally considerably hypertrophied and just about to undergo karyokinetic division: occasionally also necrosis of the nucleus and destruction of the cell protoplasm is observed. According to Soudake-

with the parasite penetrates into the interior of the cell, and in growing displaces and compresses against the cell wall first the nucleus and afterwards the protoplasm: the parasite is set free by the destruction of the infected cell, after which the capsule of the parasite itself bursts and the spores thus set free infect neighbouring cells. The most important method of propagation is said to be that which takes place in the infected cell: the cancer cell divides by karyokinesis, giving rise to two daughter cells, both of which are infected.

Buffer's method. *Examination of fresh preparations.*—With a scalpel remove a little of the cancer juice, transfer it to a slide, cover with a cover-glass, and examine with an high power dry objective. Using an Abbe condenser rounded spaces can be seen within some of the epithelial cells resembling, at first sight, vacuoles, but surrounded by a membrane with a double contour and containing a body the structure of which is difficult to make out with the condenser. If however the condenser be removed it will be seen that this body consists of a nucleus surrounded by a ring of homogeneous protoplasm.

Stained preparations can be obtained by mixing a drop of cancer juice with a drop of the stain, covering with a cover-glass and luting with paraffin. The best stain for the purpose is an aqueous solution of methylene blue containing a little aqueous solution of methyl green and very slightly acidified with acetic acid. This mixture stains the cell nucleus green and the cell protoplasm very pale blue, while the nucleus of the parasite is stained pink and its protoplasm pale blue.

Sections. *Fixing.*—Place small pieces (4–5 mm.) of the tumour for 12–24 hours in a saturated solution of perchloride of mercury. Wash in running water. Harden in different strengths of alcohol. Mount in xylol-paraffin.

Staining.—Fix the section on a slide, remove the paraffin, pass through alcohol, water, Gram's solution, alcohol and water successively. Stain by the Ehrlich-Biondi method¹ which stains the nuclei of the epithelial cells green, the nucleolus intense red, and the protoplasm red; while the nucleus of the parasite is stained red and its protoplasm is practically unstained.

The following is a better method:

(a) Stain for 1 or 2 minutes in a 5 per cent. aqueous solution of hæmatoxylin. Wash in water.

(b) Wash the section in a concentrated solution of copper sulphate until it becomes black.

(c) Transfer to a 1 per cent. solution of hydrochloric acid until the section is pale yellow.

(d) Wash again in the copper sulphate solution for a few seconds until it assumes a blue colour. Wash in a large quantity of water.

(e) Stain with an acid dye, e.g. a concentrated tincture of cochineal.

Preparations stained in this way show the cell-nucleus blue and the protoplasm reddish blue. The parasite is red.

At the present time very few pathologists regard the formations which have just been described as Coccidia. Borrel, Fabre-Domergue, Duplay and Cazin, A. Brault, Sikorsky, De Quervain have all expressed themselves as opposed to the theory that a coccidium is the cause of cancer. Without going into details of the objections which they have raised against the parasitic origin of malignant disease it may be said that the different descriptions which have been given of the supposed parasites in tumours are mutually conflicting and in no way recall the forms characteristic of the development of Coccidia; and that on the other hand there is a complete morphological similarity between the pseudo-parasites and the various appearances presented by cells undergoing degeneration. According to A. Brault the figures described as Coccidia in tumours are cellular modifications of one or other of the following types: 1. encapsulation of certain cells: 2. hyaline degeneration: 3. production of endogenous cells: 4. excessive budding of the nuclei: 5. multiple degenerations of the nuclei and nucleoli.

¹ The method is as follows: Prepare saturated aqueous solutions of methyl-violet, acid-fuchsin (Rubin S.) and aniline-orange. Leave for 3 or 4 days. Then mix 100 c.c. of the orange solution, 50 c.c. of methyl-green and 20 c.c. of acid-fuchsin. Filter. Dilute 1 volume of the mixture with 60–100 volumes of water. Leave the preparations in the diluted mixture for 24 hours, wash in strong alcohol, absolute alcohol and xylol and mount in balsam.

2. *Micrococcus neoformans*.

Doyen has found in all malignant growths and in many benign growths a coccus which he has named the *Micrococcus neoformans*. This organism appears to be the "habitual parasite" of rapidly-growing tumours in man. Doyen has also found the same organism in a rat (renal carcinoma), in a mouse and in a bitch (cancers of the mammary gland).

The coccus of Doyen, the specificity of which is more than doubtful, can also be found on the healthy skin and in glandular lesions not of a cancerous nature. Borrel has isolated it several times from cases of tuberculous mammitis.

Detection of the parasite.—Doyen sows small pieces of tumours in a broth made with cow's udder and prepared in the same way as ordinary peptone broth, using 500 grams of minced cow's udder freed from fat in place of meat.

From a non-ulcerated tumour remove with the necessary aseptic precautions small pieces of tissue and sow them in tubes containing about 1 c.c. of udder broth: the culture grows best when the tissue is not completely immersed in the culture medium. The coccus grows in 16–18 hours at 37° C. but it is not an uncommon experience to find that no growth is visible until about the fifth day.

Morphology.—*M. neoformans* is a very small coccus (0.5–2 μ in diameter), sometimes arranged singly, sometimes grouped in motile diplococci (Isaza), occasionally forming triads, tetrads or chains of 4 to 9 irregular elements.

It stains well with the basic aniline dyes and is gram-positive (at least in young forms).

It is a facultative aërobie. On sloped agar it produces a moist whitish streak which becomes glairy and ropy after 2 or 3 days. It liquefies gelatin, liquefaction commencing about the fourth day at 20° C. (In this it is differentiated from the pleomorphic coccus of the skin which does not liquefy gelatin.)

Experimental inoculation.—Inoculation of *M. neoformans* sets up in most mice and in white rats after 2 or 3 months lesions of a neoplastic nature which terminate fatally (Gobert). The lesions experimentally produced are indifferently of mesodermic or epithelial origin (lipomata, sarcomata, enchondromata, adenomata, papillomata).

It is best to inoculate into the peritoneal cavity: the lesions produced affect especially the lung, occasionally the liver and lymphatic glands. In a bitch, Doyen produced two sub-cutaneous lipomata in the region of the mammary glands.

To obtain these results Doyen inoculated an emulsion made with fragments of tumours which had been cultivated in broth for 6 or 7 days and the product from scraping agar tubes sown with this broth (Gobert). It was therefore not a pure culture which was inoculated but a mixture of a pure culture and ground-up cancer tissue.

Borrel has noticed bronchial proliferations, similar to those described by Doyen, in rats which had died spontaneously with pulmonary abscess.

Toxin.—The inoculation of filtered glycerin-broth cultures into persons suffering from cancer is followed by a reaction similar to that which tuberculin produces in tuberculous persons (Doyen).

Isaza proposes that this toxin should be used in the treatment of cancer.

Doyen has prepared a vaccine with *M. neoformans* and speaks favourably of the results obtained in the treatment of human cancer. [Sir Almroth Wright endorses Doyen's opinion as to the use of vaccines and thinks they relieve pain.]

CHAPTER LVIII.

THE INTRA-CORPUSCULAR HÆMATOZOA.

Section I.—The genus *Hæmamæba*, p. 770.

1. The hæmatozoon of malaria, p. 770.

Methods of examination, p. 770.

Structure of the parasite, p. 772. Morphology, p. 774. Life history, p. 776.

The different species of hæmatozoa found in malaria, p. 778.

Examination of mosquitos, p. 780.

Experimental inoculation, p. 781.

2. The hæmatozoon of monkeys, p. 781. 3. The hæmatozoon of bats, p. 781.

4. The hæmatozoa of birds, p. 781.

Section II.—The genus *Hæmogregarina*, p. 783.

1. *Hæmogregarina stepanowi*, p. 783. 2. *Hæmogregarina ranarum*, p. 784.

3. *Hæmogregarina lacertarum*, p. 785.

LAVERAN classified the intra-corpuseular *Hæmatozoa* or *Hæmacytozoa* into three genera: *Hæmamæba*, *Piroplasma* and *Hæmogregarina*.

SECTION I.—THE GENUS HÆMAMÆBA.

The genus *Hæmamæba* or *Plasmodium* consists of intra-corpuseular parasites which are generally pigmented and in which reproduction takes place both asexually (endogenously) and sexually (exogenously), in the latter case with the formation of flagellated parasites representing the male element.

The *Hæmamæbæ* occur as parasites in man, monkeys, bats, birds and some reptiles.

The various parasites described under the names *Hæmamæba*, *Plasmodium*, *Laverania*, *Proteosoma* and *Halteridium* (Laveran and Mesnil) must all be regarded as belonging to the genus *Hæmamæba*.

1. The hæmatozoon of malaria.

Hæmamæba malaricæ.

Synonyms.—(*Plasmodium malaricæ*—*Plasmodium vivax*—*Plasmodium præcox*—*Laverania malaricæ*.)

The pathogenic agent of malaria was discovered by Laveran.

Methods of examination.

The hæmatozoon should be looked for in the blood of infected persons preferably just before or at the commencement of the onset of an attack of fever.

In certain cachectic conditions the parasites are also found in the blood in the intervals between the attacks of fever, but as a rule they disappear from the peripheral blood during apyrexial intervals especially when the patient is being treated with quinine. The crescent form of the parasite is more resistant to this drug than the other forms.

It is best to examine the blood in the fresh state.

(a) **Examination of fresh blood.**—The patient's finger is well washed with soap and water and then with alcohol to remove the fatty secretions from the skin. The pad of the finger is then pricked with a sterilized needle and after wiping away the first drop of blood with a piece of soft linen a small drop is collected on each of a series of scrupulously clean glass slides and immediately covered with a cover-glass.

Should the drop of blood be rather large, gentle pressure may be applied to the cover-glass and the blood so squeezed from beneath it wiped away: in this manner a very thin layer of blood is obtained in which the red cells are lying flat and not piled one upon another in *rouleaux*. In the majority of cases no advantage is gained by ringing the cover-glass with paraffin, because the blood will coagulate at the edges and afford sufficient protection against evaporation: but in studying the movements of the parasites it is well to adopt this precaution so that the movement imparted to the red cells by the evaporation taking place at the edge is avoided. The preparation ought to be examined with an high power dry objective.

The living parasite may be stained in the following manner. A drop of methylene blue in 0.75 per cent. normal saline solution is placed on the slide by the side of the drop of blood. A cover-glass is lowered on to the two drops which mix with the result that the parasites soon take up the dye—which is not toxic to them—and then stand out more sharply against the unstained background (Neveu-Lemaire). Celli and Guarnieri use a solution of methylene blue in ascitic fluid for the purpose.

(B) **Examination of dried films.**—Blood dried on cover-glasses may also be used for investigating the presence of hæmatozoa and studying their characters. The films may be prepared on cover-glasses in the ordinary way, though sometimes it is preferable to spread the blood on slides in the following manner:—A little drop of blood is placed at one end of a slide and spread with the edge of another slide—a visiting card or cigarette paper will do as well—by drawing the latter rapidly towards the other end of the slide with a single uninterrupted motion (p. 204). The preparation is dried as rapidly as possible in the air and then fixed in alcohol-ether or, better, in absolute alcohol for 10–20 minutes. Fixation by heat is too crude and altogether unsuitable.

To examine dried preparations unstained the films on the cover-glasses are simply laid on a slide and fixed by their edges with paraffin.

Methods of staining.—The Hæmatozoa may be stained with various dyes, methylene-blue, gentian-violet, violet-dahlia and Boehmer's hæmatoxylin being especially useful.

Blood films prepared as above on slides or cover-glasses may be stained by one of the following methods.

1. **Methylene Blue.**—(a) The film is stained for 30 seconds in a saturated aqueous solution of methylene blue, washed, dried and mounted in balsam. The red cells are unstained, the nuclei of the leucocytes appear deep blue and the parasites pale blue.

Manson recommends the use of Loeffler's alkaline blue (p. 139). Koch prefers borax blue (borax 5 grams, distilled water 100 c.c. methylene blue 2 grams). Stain for 30 seconds, wash in water, dry and mount in balsam.

(b) Stain in 0.5 per cent. solution of eosin, then in an aqueous solution of

blue in the manner just described. The preparation is thus double stained, the red cells being pink, the nuclei of the leucocytes and the parasites blue. This method is recommended by Laveran.

(c) The films may be stained with the eosin-methylene-blue mixture of Chenzinsky (p. 210).

2. Violet stains.—The films may be stained, for a few seconds only, in a saturated aqueous solution of gentian-violet or violet-dahlia or in Bœhmer's hæmatoxylin. If carbol-thionin be used the staining should be prolonged to 5 minutes. After staining the films are washed, dried and mounted in balsam. The red cells are unstained while the nuclei of the white cells and the parasites are stained violet; the pigment granules are barely visible.

Ross's method for the detection of the parasites.—The parasites are present in the blood in small numbers only as a rule, and their detection in thin films on cover-glasses is often a tedious undertaking. Ross therefore takes about 20 cm. of blood and spreads it in a thick layer on a slide which, after drying over a flame but without fixing the film, is washed in water; in this way the hæmoglobin is dissolved and removed. The film is now stained for 1 minute in a 1 per cent. aqueous solution of eosin followed by an alkaline solution of methylene blue for 15–30 seconds (1 per cent. aqueous solution of methylene blue to which 0.5 per cent. of carbonate of soda has been added and heated until it acquires a purple tint): it is finally washed in water, dried and mounted in balsam. This method yields a transparent preparation in which only the leucocytes and parasites are stained and so allows of the latter being readily found. Ruge advises the use of Ross's method, taking care to fix the preparation (so as to obviate the chance of the blood being detached during washing) in a 2 per cent. solution of formalin containing 1 per cent. acetic acid. This method of fixing in no way interferes with the solution of the hæmoglobin.

Le Dantec's method.—In cases in which the parasites are present in very small numbers, Le Dantec advises hæmolyzing 1 c.c. of blood by collecting it in 20 c.c. of water, centrifuging the mixture and examining the deposit for parasites.

Structure of the parasite.

The staining of the nuclei of Hæmatozoa is difficult and requires special methods.

Laveran's method. Recommended.—This method is based on the use of Borrel's blue.

Preparation of Borrel's blue.—Dissolve some crystals of silver nitrate in 50 c.c. of distilled water in a flask of about 150 c.c. capacity. Fill the flask with a 10 per cent. solution of soda and shake. The black precipitate of silver oxide which is thus obtained is then carefully washed several times in distilled water and after decanting the last washing a saturated aqueous solution of medicinal methylene blue (Höchst) is added. The solution is shaken several times and allowed to stand for 10 to 15 days; the supernatant fluid which is then decanted constitutes *Borrel's blue*.

The dried blood films after fixing for 10 minutes in absolute alcohol are stained with the following solution, which must be made up just before use:

| | | | | | | | | | |
|---|---|---|---|---|---|---|---|---|------|
| Borrel's blue, ¹ | - | - | - | - | - | - | - | 1 | c.c. |
| 0.1 per cent. aqueous solution of eosin, ² | - | - | - | - | - | - | - | 5 | „ |
| Distilled water, | - | - | - | - | - | - | - | 4 | „ |

Mix carefully. The eosin and methylene blue solutions must be filtered just before mixing but the mixture itself should not be filtered.

The stain is poured into a flat vessel (Petri dish or special rectangular dish) and the slide immersed film side downwards, being prevented from touching

¹ The solution of Borrel's blue ought to be prepared afresh should it rapidly give a heavy precipitate after mixing with the eosin solution.

² Water-soluble eosin (Höchst).

the bottom by means of a little piece of glass rod or a protuberance of the vessel ; otherwise a precipitate is generally deposited on it.

If the film has been made on a cover-glass this may be floated, film downwards, on the surface of the stain in a watch-glass.

After staining for the necessary length of time (5–10 minutes in the case of recently prepared films of malarial blood, and somewhat longer for older films, and several hours in the case of the *Hæmatozoa* of birds) the films are washed in a liberal quantity of water, treated with a 5 per cent. watery solution of tannin for about 2 minutes and finally washed again in distilled water and dried.

If the staining be too intense or if a copious precipitate be formed the preparations must be washed in absolute alcohol or clove oil and then in xylol.

If the preparation is to be kept it is better not to mount it in balsam or cedar wood oil, which will soon dissolve the stain.

The red cells are stained pink and the nuclei of the leucocytes deep violet : the protoplasm of the parasite assumes a pale blue colour and the chromatin of its nucleus becomes violet or purplish red : pigment granules (Schüffner's dots) appear in the bodies of the red cells containing parasites.

Romanowsky's method (p. 210) is applicable to the staining of *Hæmatozoa*. The nuclei of the parasites are stained purplish-red and their protoplasm blue.

This method is merely of historical interest and is now no longer used in practice : the results are often disappointing.

The success of the method depends upon the formation, under certain conditions, of violet and azur from methylene blue ; these colour-changes are produced either by treating methylene blue with a dilute alkali (polychrome blue) or by obtaining azur from methylene blue by more or less complicated processes. Most of the Romanowsky methods have been described in connexion with the spirochæte of Syphilis (p. 727) : in this chapter only those which are especially applicable to the study of the *Hæmatozoa* will be considered.

Leishman's stain.—Leishman's method is a modification of that described by Nocht, which depends upon the action of sodium carbonate on methylene blue.

Prepare a 1 per cent. aqueous solution of medicinal methylene blue (Grübler) and add 0·5 per cent. sodium carbonate : heat for 12 hours at 65° C. and keep for 10 days at the temperature of the laboratory. Prepare also a 0·1 per cent. aqueous solution of eosin (eosin BA Grübler). Mix equal volumes of the two solutions and leave for 10 hours or so, shaking the mixture at frequent intervals. Filter, wash the precipitate with distilled water until the washings are a very pale blue, collect the precipitate on the filter, dry and powder. (Leishman's stain in powder can now be obtained from Grübler).

The staining solution is prepared by dissolving the powder in absolute methyl alcohol (0·15 per cent.). For use, 3 or 4 drops of the stain are poured on the film, and after 30 seconds 6–8 drops of water are added and the diluted stain allowed to act for a further 5–10 minutes. Wash in water and leave the water on the film for a minute. Dry and mount in balsam. When stained by this method the red cells are pale pink or greenish pink in colour, the nuclei of the leucocytes red, the *Hæmatozoa* blue and their chromatin ruby-red.

Jenner's stain.—This method, like that of Wright, is based upon the use of the product obtained by the interaction of solutions of methylene blue and eosin. The stain is sold in the dry form by Grübler.

The film, which does not require fixing, is stained for 3–5 minutes in the following solution.

| | | | | | |
|-------------------------------------|---|---|---|---|----------|
| Jenner's stain in powder (Grübler), | - | - | - | - | 1 gram. |
| Pure absolute methyl alcohol, | - | - | - | - | 100 c.c. |

The preparation should be covered during the staining process to prevent evaporation of the alcohol.

Wash rapidly (for a few seconds) in distilled water. Dry. The preparation may be examined and preserved at this stage or may be mounted in balsam. The colour reactions are the same as with Leishman's stain.

Giemsa's stain.—This method is based upon the use of a mixture of solutions of azur II and eosin, and has been described at p. 727. Laveran modified the technique somewhat to make it applicable to the staining of Hæmatozoa.

The dried blood film is fixed in absolute alcohol and then stained for 10 minutes in the following solution :

| | |
|--|--------|
| 0·1 per cent. aqueous solution of eosin, - - - - | 2 c.c. |
| Distilled water, - - - - | 8 " |
| 0·1 per cent. aqueous solution of azur II, - - - - | 1 " |

Wash in water, treat for 2 minutes with a 5 per cent. aqueous solution of tannin. Wash, dry and mount.

Marino's stain.—This method, which has already been described at p. 727, may be used to stain the Hæmatozoa. It is based upon the use of a mixture of eosin, methylene blue and azur.

Morphology.

Appearance in human blood.

In the blood of persons infected with malaria the hæmatozoon assumes one of the following forms.

1. **The intra-corpuseular amœboid form** (Spherical body) [Ring parasite].—The amœboid trophozoites within the red cells are the forms most commonly seen. They are small spherical structures 1–6 μ in diameter, composed of an hyaline, colourless, transparent protoplasm, and since they exhibit amœboid movements are sometimes known as the *amœboid bodies*. As a rule they appear like small clear specks attached to the red cells.¹ Two, three and even four parasites may be present in one red cell. Occasionally they are found free in the serum.

Even the smallest of the amœboid bodies sometimes contain one or two grains of black pigment (*melanin*), and as the parasite increases in size pigment becomes more abundant. The pigment grains are sometimes arranged like a wreath around the margin of the amœboid body and at other times dotted irregularly through the substance: they often show active movement which is more irregular and less constant than Brownian movement.

The amœboid bodies have in addition a nucleus, situated excentrically, attached to the periphery, and difficult to stain. In preparations stained with methylene blue, the protoplasm of the parasite is coloured blue while the nucleus is represented by a clear vacuole. Stained by Romanowsky's or Laveran's method a chromatin granule within the nucleus is stained violet.

In fresh blood films, at the end of half to three-quarters of an hour the amœboid movements cease and the parasite dies; the margins then become irregular and the grains of melanin accumulate irregularly in various parts of the parasite.

¹[This is now considered to be merely an appearance. The parasites are believed to be always *within* the red cells.]

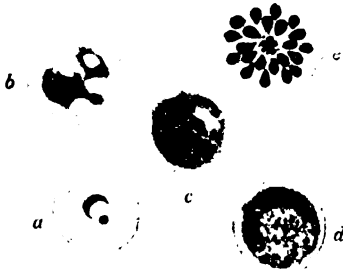

FIG. 371.—The malarial parasite in human blood. $\times 1000$. a, The young intra-corpuseular amœboid, or ring parasite; b, at a later stage; c and d, stages in the segmentation of the schizont; e, merozoites formed from segmenting schizont. (Diagrammatic.)

2. The rosette or marguerite form.—The rosette, marguerite or segmenting forms represent the schizogonous mode of reproduction of the *Hæmatozoon* of malaria. They are only met with in very small numbers in chronic conditions and are best looked for during the early stages of an attack of fever: sometimes they are not to be found in the peripheral blood but only in the liver and spleen.

In some of the amœboid bodies the margins will be seen to be slightly indented and the pigment grains collected in the centre of the parasite—this is the first stage of schizogony. The periphery soon becomes more deeply indented and gives the parasite a marguerite appearance: each segment then separates from its neighbours, in such a way that a number of little spherules (*merozoïtes*) are formed, none of which contain pigment—pigment being only found in the adult forms of the parasite.

The number of segments into which the marguerite form breaks up is very variable (six to twenty). According to Golgi, those breaking up into eight segments are found in quartan fever, those giving rise to sixteen or twenty spherules in tertian fever (p. 180).



FIG. 372.—The *hæmatozoon* of malaria. $\times 1000$. a, the crescent form of macrogamete; b, the crescent form of microgametocyte (*Plasmodium praecox*). (Diagrammatic.)

FIG. 373.—The *hæmatozoon* of malaria. $\times 1000$. a, macrogamete; b, microgametes separating from the microgametocyte (flagellated body). (Diagrammatic.)

3. The crescent form.—Crescents are seen in the blood of persons who have been infected for a long time and are suffering from malarial cachexia.

The crescent-shaped parasites measure $8-9\mu$ long by about 2μ broad: their protoplasm is transparent and colourless except for a collection of black pigment grains in the centre. On their concave side a very fine line is often seen connecting the two horns of the crescent. Crescents are either found free in the serum or attached to red cells.

Laveran was the first to show that these crescents later change their shape, becoming first oval then spherical. Crescents represent a stage in the sexual life-history (*sporogony*) of the *Hæmatozoon* (*vide post*).

4. Flagellated bodies.—At the periphery of certain medium-sized spherical parasites motile filaments (*flagella*) are sometimes seen which are endowed with considerable powers of movement and displace the red cells in their neighbourhood. The flagella are three or four times the diameter of a red cell, but so transparent and delicate that when at rest it is almost impossible to see them. One to four flagella may originate from a single spherical body and these may be arranged symmetrically around the parasite or grouped together at the same point. The flagella move independently of each other, and their displacement often imparts some slight movement to the spherical

body; sometimes it is a mere movement of oscillation, sometimes a true movement of translation.

Certain flagella show a slight pear-shaped swelling at their free extremities.

At a given moment the flagella detach themselves from the spherical bodies and, becoming free, move about among the red cells in the field of the microscope. As soon as the flagella have separated the spherical bodies lose their shape and the grains of pigment in them collect together in a mass.

Morphologically, the flagellated bodies represent *microgametocytes* and the flagella the *microgametes* (*vide infra*). They are never formed in the circulating blood, but appear very soon in blood which has been withdrawn from the vessels and equally quickly disappear from it. Their complete life-history can only take place in the alimentary canal of certain mosquitos.

The method of examining blood for flagella.—In examining blood for the flagellated forms of the parasite it is advisable to let the blood stand for a few minutes after it leaves the body. Collect a small drop of blood on a slide which has been moistened by breathing upon it, and if possible from a patient in whose blood the crescent forms are numerous, spread it rapidly with a needle and invert it on to a moist chamber—made by placing a thick fold of blotting-paper soaked in water, and from the centre of which a rectangular piece about 2.5 cm. × 1.5 cm. has been cut out, on a sheet of glass. Manson recommends leaving the slide under these conditions for 15–45 minutes, then dry in the flame, fix in absolute alcohol, wash in 20 per cent. solution of acetic acid in water to dissolve the hæmoglobin, wash in water, stain according to the directions given above, dry and mount.

The life-history of the malarial parasite.

Like the Coccidia, the hæmatozoon of malaria has two methods of reproduction.

1. *Asexual reproduction* or *schizogony*, which occurs in the blood of the human subject.

2. *Sexual reproduction* or *sporogony*, which takes place outside the human body in the alimentary canal of certain mosquitos of the genus *Anopheles* (Ross, MacCallum, Laveran, Manson, Grassi, Bignami and Bastianelli, and others).

(a) **Schizogony or asexual cycle.**—The intra-corpuseular amœboid parasite—*spherical body* or *schizont*—having reached maturity undergoes schizogony. The nucleus divides into a number of daughter nuclei which pass towards the periphery of the parasite, and the protoplasm also divides by means of sulci passing in from the periphery; thus the schizont assumes a daisy or marguerite appearance, the pigment accumulates in the centre and the segments marked off by the segmentation of the daisy-shaped body constitute the *merozoïtes*. These are set free in the blood stream by the rupture of the red cell and attaching themselves to other red cells, penetrate the latter, grow, become pigmented and again form adult schizonts.

Schizogony occurs over and over again, and by this process of endogenous reproduction the parasite multiplies in the tissues with extreme rapidity: in tertian fever, for instance, a new generation is produced every other day. The onset of the fever coincides with the discharge of the merozoïtes into the blood stream.

(β) **Sporogony or sexual cycle.**—Besides the amœboid bodies and the daisy forms (schizonts), *gametes* represented in one species by *crescents*, and in other species by *free spherical bodies* larger than the schizonts, are found in the blood of malarial patients: these gametes, whether crescent-shaped or spherical, are derived “from merozoïtes which, exhausted by a long series of schizogonic multiplications, have, for this reason, undergone evolution in another direction” (Blanchard).

Gametes cannot multiply in the blood of man and can only propagate their species in the digestive tube of certain mosquitos. In the crescent forms of gametes two kinds can be distinguished; the female gametes or *macrogametes* (fig. 374, E) which are longer, more slender and have the pigment more closely concentrated about the nucleus, and the male gametes or *microgametocytes* (fig. 374, D) which are shorter and stouter and have the pigment more scattered through the cell protoplasm.

[In the spherical forms of gametes the male and female cells are not so easily distinguished though if the male cell be watched in a fresh preparation under the microscope it will be seen in due course to extrude its flagella.]

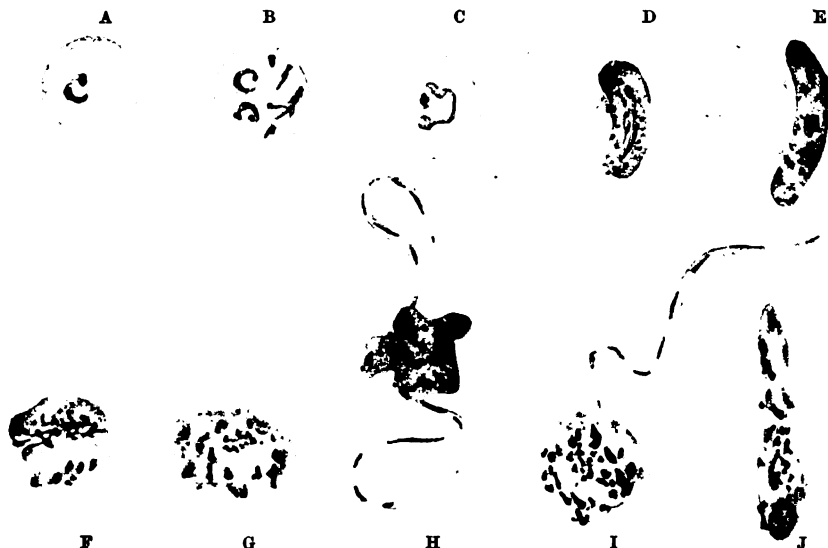

FIG. 374.—The hæmatozoon of malaria. Stained by Leishman's method.—Amoeboid or ring parasites: gametes: crescents: flagellated bodies. A, B, C, amoeboid trophozoites in a red cell; D, male crescent; E, female crescent; F, male spherical gamete; G, macrogamete; H, flagellated body or microgametocyte; I, fertilization of a macrogamete by a microgamete; J, zygote.

When a female mosquito of the genus *Anopheles* (the males do not bite) bites a person suffering from malaria it withdraws a certain amount of blood containing the various forms of the parasite which have already been described: in the alimentary canal of the mosquito the young amoeboid parasites and schizonts are rapidly destroyed but the gametes survive and undergo sexual reproduction. The *macrogametes*, or female cells become spherical (fig. 374, G) and have a small irregular centrally situated mass of chromatin (fig. 374, G). In the *microgametocytes*, or male cells, the chromatin splits, generally into four secondary nuclei, (fig. 374, F) which travel towards the periphery, protrude from the protoplasm of the cell and become drawn out into long, slender, motile filaments, *flagella* or *microgametes* (fig. 374, H), which soon become detached and go in search of the macrogametes. After the *flagella* are detached the microgametocyte soon dies. The microgametes meet the macrogametes in the stomach of the mosquito, penetrate and fertilize them (fig. 374, I): the fertilized macrogamete constitutes the *zygote*.

The young *zygote*, spherical in the first instance, elongates (fig. 374, J), moves towards the wall of the stomach of the mosquito and passes between the

epithelial cells lining the mucous membrane, again changes to the spherical shape and forms a small cyst in the muscular wall. Measuring at first 6μ in diameter it gradually grows, lifting the outer wall of the stomach and forming a hernia into the body cavity of the insect, until it ultimately attains a diameter of $60-80\mu$. Its chromatin is collected into a central mass.

Changes now begin, culminating in the formation of the *oocyst*. The chromatin splits into numerous small fragments which, passing to the periphery and becoming surrounded with protoplasm, form the sporoblasts (fig. 375). From the sporoblasts are formed the *sporozoites*, which are at first spherical but subsequently elongate and become pointed at the ends. Then the oocyst bursts (fig. 376) and the *sporozoites* are set free into the body cavity of the mosquito, from whence they are swept along by the circulation into the thorax and head and invade especially the salivary glands. When an *Anopheles* mosquito thus infected bites a healthy individual it inoculates into the victim's blood both its venin and these sporozoites. The sporozoites act as merozoites, infect the red cells and give rise to intra-corpuseular spherical amœboid parasites.



FIG. 375.—The hæmatozoon of malaria. Ripe oocyst. (After Grassi.)

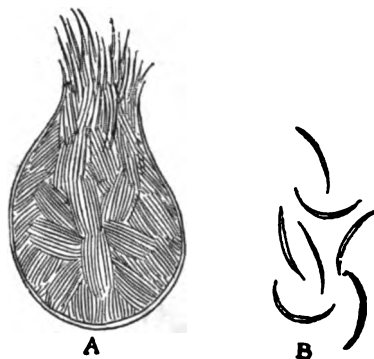

FIG. 376.—The hæmatozoon of malaria. A ruptured oocyst from which the sporozoites are escaping. (After Grassi.)

The different species of hæmatozoa found in malaria.

Golgi, Grassi and Feletti, and other Italian observers have for a long time considered that there is more than one species of the malarial hæmatozoon and the majority describe three, corresponding to the parasites of quartan, tertian and the irregular tropical fevers. Manson however considers that there are five species corresponding to as many different clinical types of the disease.

In the present chapter Golgi's classification will be followed.

FIG. 377.—Life history of the malarial parasite (after Grassi and Schaudinn).
A. Schizogony. 1. A free sporozoite. 2. A sporozoite entering a red cell. 3, 4, 5, 6. Growth of the intracorpuseular amœboid parasite preceding multiplication and division into merozoites. 7. Merozoites which have burst the red cell and become free in the blood stream. Some merozoites penetrate other red cells and pass through the same series of changes (1-7) others become gametes.
B. Sporogony.—9a-14a. Growth and differentiation of the female cell or macrogamete.—9b-13b. Growth and differentiation of the male cell or microgametocyte. 14b. Budding off of microgametes from the microgametocyte. 15b. Free microgamete or flagellated body.—16. Fertilization of the macrogamete by the microgamete. 17. The fertilized cell or zygote (ookinete). 18. Infection of the epithelial cells lining the walls of the mosquito's stomach. 19-24. Growth and development of the oocyst and formation of sporozoites within it. 25-27. Rupture of the oocyst, and discharge of the sporozoites which travel to the salivary glands of the mosquito. 1. Discharge of a sporozoite from the mouth during biting. (From Mense's *Handbuch der Tropenkrankheiten*.)

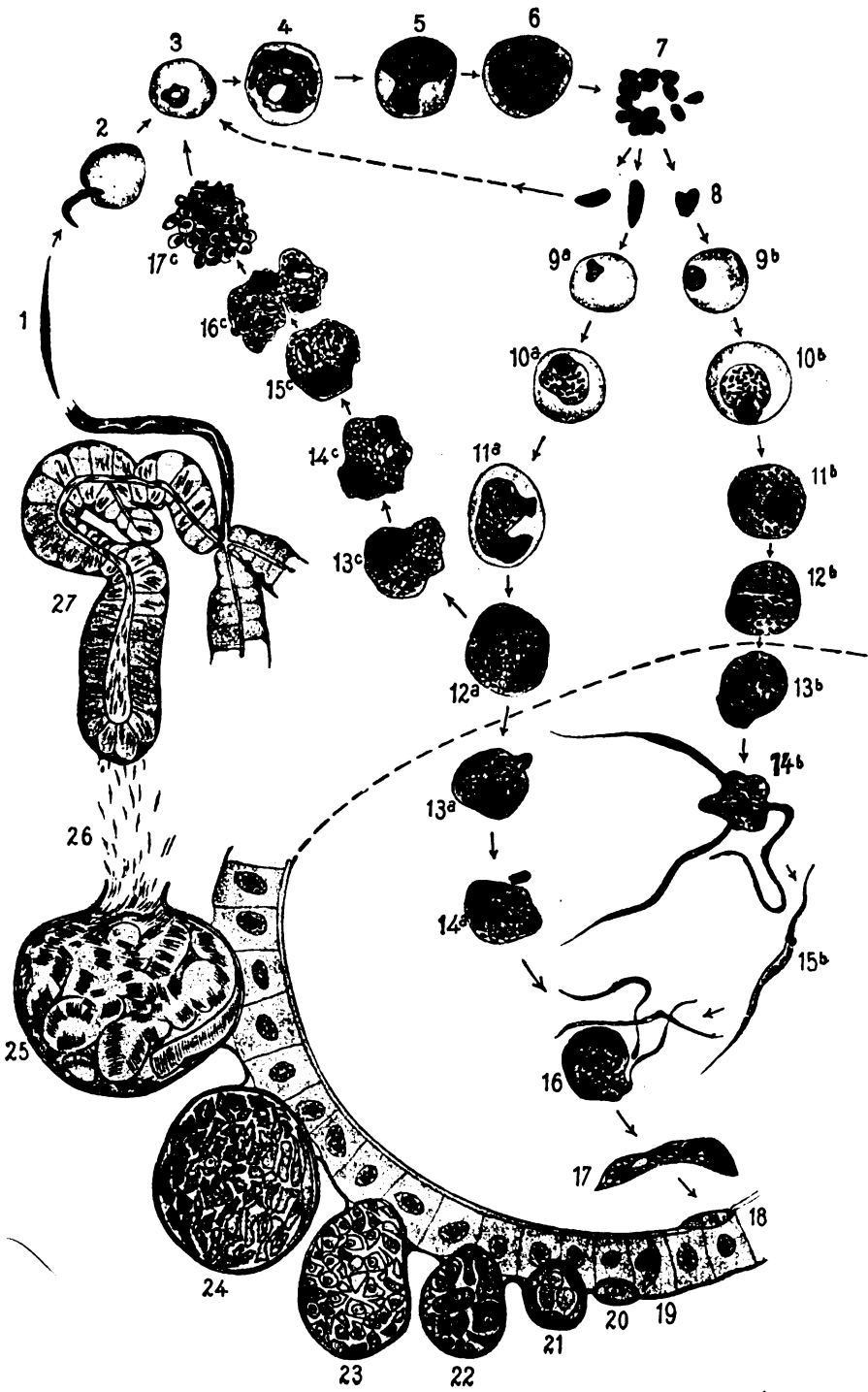

FIG. 377.

1. *Plasmodium malariae*.—This is the parasite of quartan fever: its life-cycle occupies 72 hours, and the young forms exhibit very slow amœboid movements. The intra-corporal amœboid bodies are smaller than a normal erythrocyte. The pigment grains are numerous and large and show very little movement. The parasite forms a rosette made up of 6 to 12 merozoites with the pigment all collected in the centre: it does not form crescent gametes.

2. *Plasmodium vivax*.—The parasite of benign tertian malaria; its life-cycle occupies 48 hours, and the young forms show more active movements than the young forms of *P. malariae*. The amœboid forms are larger than a red blood corpuscle, and the infected cell hypertrophies, becomes pale and is filled with characteristic fine red granules (Schüffner's dots). The parasite contains numerous, fine, highly motile grains of pigment: the rosette is formed of 12 to 20 merozoites: no crescent gametes are formed.

3. *Plasmodium præcox* (*Laverania malariae*).—The parasite of tropical, pernicious, irregular, quotidian, malignant tertian and æstivo-autumnal fevers. Young forms show very active amœboid movement. The intra-corporal parasites are so small that a single red cell can contain several of them: the pigment grains are scanty, fine, and exhibit little motility: the rosette is constituted of 6 to 15 small merozoites: the gametes are crescent-shaped. The infected blood cells retain their natural size and assume a deep copper colour. Parasites are only present in small numbers in the peripheral blood but abound in the blood of the internal organs. The period of the life-cycle is irregular and may be 24 or 48 hours or longer.

Laveran holds that the parasites found in malaria are not different species but merely varieties of the same species and distinguishes three such varieties:—*Hæmamoeba malariae* var. *parva*, *tertiana*, *quartana*. Laveran has seen changes taking place which he regards as a change from one variety to another. *Hæmamoeba malariae parva* corresponds to *Laverania malariae*, the parasite of the pernicious and tropical fevers. In Laveran's opinion clinical observation and microscopical investigation agree in showing that all forms of malaria are clinically and ætiologically the same disease.

Metchnikoff and van Gorkone accept Laveran's views. According to van Gorkone the variations in size, motility and morphological appearance are due to the rapidity of growth of the Hæmatozoa, which depends upon whether the blood of the person infected is relatively favourable to their development or not.

The examination of mosquitos.¹

Neveu-Lemaire recommends the following method.

A few drops of chloroform are poured on the wool plug of the tube containing the insect. When the mosquito is anæsthetized the legs and wings are pulled off and the body laid on a slide.

To withdraw the stomach fix the mosquito by pressing with a needle at the junction of the thorax and abdomen, then with a second needle pull gently on the last two segments of the abdomen, holding the needles horizontally: the stomach ruptures at its junction with the œsophagus and is withdrawn with the intestines. It may now be examined in one or other of the following solutions:

| | | | | | | |
|-------------------------|---|---|---|---|---|-------------|
| 1. Commercial formalin, | - | - | - | - | - | 2 grams. |
| Distilled water, | - | - | - | - | - | 100 " |
| 2. Sodium chloride, | - | - | - | - | - | 1.50 grams. |
| The white of one egg. | - | - | - | - | - | |
| Distilled water, | - | - | - | - | - | 250 " |

Filter before use.

¹ For a detailed account of the classification of mosquitos and of the methods of examination the reader is referred to *Moustiques et maladies infectieuses* by Ed. and Ét. Sergent. [A full account of the Structure and Biology of Anopheles is given by Nuttall and Shipley in the *Journal of Hygiene*, vol. i. (Camb. Univ. Press).]

The preparation should first be examined under a low power of the microscope and when a cyst is found a higher power or a $\frac{1}{2}$ immersion lens is turned on. If there is still some blood in the stomach it may be mixed with a 0.75 per cent. saline solution: the blood flows into the liquid and the preparation is covered with a cover-glass and examined for parasites.

The examination of the salivary glands is more difficult, and the dissection should be done with a lens. Fix the middle of the thorax by laying a needle horizontally across it, then with a second needle gently tear away the head, taking the three lobes of the salivary gland with it.

The glands should be examined in the following solution:

| | | |
|--------------------------------|------|--------|
| Distilled water, - - - - - | 100 | grams. |
| Commercial formalin, - - - - - | 2 | " |
| Sodium chloride, - - - - - | 0.75 | gram. |

Staining method.—Dissect the stomach in a 0.75 per cent. solution of sodium chloride: fix for 1 minute in osmic acid vapour, stain with picro-carmin and mount in glycerin.

Any parasites which may be present in the undigested blood in the stomach can be examined by preparing a blood film with a drop of the saline solution in which the stomach was dissected and staining in the manner described on p. 771.

The sporozoites can also be examined by gently pressing upon and rupturing one of the oocysts into the saline solution in which the stomach was dissected and then examining a drop of the fluid under the microscope.

Sections.—The best method is to fix the whole mosquito. After removing the legs and wings pour a little boiling acid perchloride (p. 189) on to it. The body will break up into two or three pieces which can then be embedded in paraffin. The sections must be cut very thin and should be stained with Böhmer's or Heidenhain's hæmatoxylin.

Experimental inoculation.

The disease can be reproduced experimentally by inoculating the parasite into man: to ensure the success of the experiment it would appear best to inoculate infected blood into a vein. Eight to ten days after the inoculation parasites appear in the blood and symptoms of malaria develop.

Man can be also experimentally infected with malaria by being bitten by an *Anopheles* which has sucked the blood of infected persons. Manson infected his son [and his laboratory attendant] neither of whom had ever been out of England, by allowing them to be bitten by mosquitos fed on malarial blood sent from Rome.

Monkeys are immune to the human parasite and all attempts to infect the lower animals have failed.

It has not been possible to cultivate the hæmatozoon outside the body.

2. The hæmatozoon of monkeys.

Hæmamoeba kochi.

Koch, Kossel, Bruce and Nabarro, and Laveran have described an intracorpuseular hæmatozoon in several species of monkeys but chiefly in the *Cercopitheci*. In the fully grown form the parasite appears as a spherical pigmented body: a rosette stage has not been seen. Monkeys cannot be experimentally infected.

3. The hæmatozoon of bats.

Dionisi has found an Hæmatozoon of the genus *Hæmamoeba* (*H. melani-phaera*) in bats (*Miniopterus schreibersii*).

4. The hæmatozoa of birds.

Hæmatozoa closely related to the hæmatozoa of malaria have been found in the blood of many birds (jays, magpies, rooks, crows, hawks, screech owls,

owls, pigeons, chaffinches, larks, etc.). These parasites, which have been variously described as *Halteridium*, *Hæmamæba*, *Proteosoma*, *Laverania* and *Plasmodium*, have been investigated by Danilewsky, Laveran, and by Grassi and Feletti. According to Laveran they should all be included in the genus *Hæmamæba*.

Though the Hæmatozoa found in different birds resemble each other very closely, Laveran considers that they represent several species:—

Hæmamæba relictæ (*Pl. relictum*, *Proteosoma* of Labbe):

Hæmamæba danilewskyi (*Halteridium danilewskyi*, *Pl. danilewskyi*):

Hæmamæba ziemanni (*Pl. ziemanni*):

Hæmamæba majoris.

The Hæmatozoa of birds are generally attached to the surface of or contained within the red cells. Most commonly the parasites are spherical but occasionally ovoid: they alter the shape of the infected blood cell which they gradually destroy and thus become free in the blood. In the mature condition they may assume one of two forms and these have been studied in the case of *Hæmamæba danilewskyi* by MacCallum, Opie, and by Marchoux and Laveran.

1. Finely granular forms, staining well with methylene blue and containing scattered grains of pigment. Stained by Laveran's method (p. 772) the nucleus is seen to be rounded or oval, situated towards the centre of the parasite and containing a small karyosome: the nucleus is stained violet and the karyosome a deep violet. These represent the *female elements*.

2. Hyaline forms containing large granules of pigment at the extremities. These stain feebly with blue, and have a large very elongated nucleus with irregular outline and occupying the whole of the centre of the parasite: after leaving the red cell, these parasitic forms assume a spherical shape and give origin to *flagella*. They represent the *male elements*. The flagella are 4 to 6 in number on each parasite and have an enlargement which varies in shape and position: situated near the enlargement is a mass of chromatin.

After separating from the microgametocyte the flagella meet, penetrate, and fertilize the female cells.

Segmented bodies or *rosette forms* are seldom seen (Danilewsky) and have never been met with in *H. danilewskyi* (Laveran) but are found in *H. relictæ*.

H. relictæ is a common parasite of sparrows in the Roman Campagna. The examination of a drop of blood from an infected bird shows adult forms, spherical or oval and pigmented, young unpigmented forms, segmented bodies, and microgametocytes extruding flagella. Ross has shown that *H. relictæ* passes a part of its life-cycle in certain mosquitos (*Culex pipiens*) and that the infection is transmitted by the bites of these insects.

It is not proved that the Hæmatozoa found in birds produce disease or cause fever. As a rule birds infected with hæmatozoa do not show any symptoms of disease, but Danilewsky has shown that at certain times the birds become ill and may even die, and that in these cases rosette forms are found in the blood.

Birds cannot be infected with the human Hæmatozoa, but are susceptible to infection with infected blood from birds of the same species (Celli and Sanfelice, Laveran).

Mattei failed to produce infection by inoculating infected pigeon's blood into the veins of a man.

Quinine though eminently efficient against the Hæmatozoa of man has no action on the Hæmatozoa of birds.

Methods of examination.—Blood is obtained by pricking one of the veins



FIG. 378.—*Hæmamæba danilewskyi*. × 1000. Pigeon's blood. Male and female gametocytes.

in the fold of the wing with a needle after plucking a few feathers. The blood should be collected in a pipette.

[Manson says: "The pad of the terminal phalanx of the bird's toe is cleaned with spirit, dried and deeply pricked with a needle: a droplet of blood is then expressed and mounted in the usual ways."]

Films should be prepared and treated in the same way as human malarial blood (p. 771).

Padda oryzivora [Java sparrow] is a very suitable species for the study of the hæmatozoa of birds: it is easily obtained from bird dealers and in three cases out of four in birds recently imported from Indo-China the blood contains *H. danilewskyi* (Laveran).

SECTION II.—THE GENUS HÆMOGREGARINA.

The blood parasites of the cold-blood vertebrata (fish, tortoises, crocodiles, pythons and all kinds of snakes, frogs, salamanders, tritons, etc.) belong to the genus *Hæmogregarina* (Laveran, Mesnil) with which must be included the genus *Drepanidium* of Lankester and the genus *Danilewskyia* of Labbé. These hæmatozoa are very numerous and some sixty species have been described.

It is now known that several species of the genus are also parasitic in the mammalia (Gerboises, etc.). S. P. James has described a parasite, *Leucocytozoon canis*, inhabiting the white blood-cells of dogs in India, which should apparently be included in the genus *Hæmogregarina*.

1. *Hæmogregarina stepanowi*.

This Hæmatozoon was discovered by Danilewsky in the common tortoise (*Cistudo europæa*) in which it is a very common parasite especially of the adult tortoise and particularly in spring and summer.

I. Laveran describes two forms of the parasite in the blood of the peripheral circulation:

(i) Reniform, intra-corpuseular parasites measuring 10–14 μ long, with rounded extremities and granular protoplasm with a nucleus near the centre, but containing no pigment. In the fresh condition, the nucleus appears as a clear, rounded or oval space which stains more deeply than the cytoplasm with methylene blue. This form of the parasite predominates in the blood of some tortoises.

(ii) Worm-like parasites situated within the red cells and nearly always folded upon themselves. This form is derived from that just described in the following manner:—When a reniform parasite has attained a length of about 10 μ it gives origin to a segment which is folded back upon the original parasite and gradually increasing in length gives to it the worm-like appearance.

The vermicules thus folded upon themselves measure 15–18 μ long; one segment has a swollen extremity while the other is pointed: the nucleus is generally seen at the bend and is sometimes compact, sometimes elongated, and sometimes divided into two, the two portions being connected by a fine thread of protoplasm (*en besace*); more uncommonly it consists of two distinct parts. It is especially well seen in stained preparations. The vermicules are never pigmented.

If the blood be fixed immediately it leaves the body only intra-corpuseular vermicules will be seen, but if the blood be kept for an hour or so, free motile vermicules will be found. These movements are very active and varied, and during progression it will often be noted that an annular constriction seems to form round the anterior end of the parasite and pass in a peristaltic wave like a series of rings towards the posterior end.

II. The reproduction forms of the parasite are found in the bone marrow (Danilewsky) but especially in the liver (Laveran).

According to Laveran, the forms corresponding to the reproduction phase consist of ovoid parasites measuring 10–16 μ long, at first intra-corpuseular and later free: they contain granules of chromatin staining with methylene blue and several nuclei

arranged in groups of three or four at each extremity. Later, the contours of the embryonic parasites appear, the ovoid body divides either regularly or splits up like the staves of a barrel. The embryonic parasites, which may be either free or contained in the red cells, are elongated, sometimes slightly bent, swollen at one end and pointed at the other: the nucleus is situated at the swollen end. The free parasites are endowed with movement, thus enabling them to penetrate the red cells.

Reproduction forms are also found but more rarely, in scrapings from the spleen.

The reproduction forms of *H. stepanovi* described by Laveran which represent the endogenous method of reproduction of the parasite are very rarely seen, and this may explain the slight pathogenic properties of the parasite. The exogenous method of reproduction was for a long time unknown: the disease is not transmitted directly from infected to non-infected animals and infected tortoises do not excrete a parasite capable of living outside the body. According to Siegel *H. stepanovi* has a second host in a leech (*Placobdella catenigera* vel *Hæmentaria costata*). In the villi of the hind gut of this leech Siegel found the microgamete stage and oocysts resulting from the fertilization by microgametes of the serpentine parasites found in the blood of the tortoise. These oocysts pass into the blood spaces and thence into the heart of the leech. In the œsophageal glands Siegel found spirilliform bodies which are probably sporozoites capable of infecting other leeches: these structures have also been found in the œsophageal glands of the embryo leeches during vitelline nutrition; it is probable therefore that the egg itself becomes infected.

Methods of examination.—Laveran recommends the following technique.

(a) **Blood.**—Blood may be obtained by cutting the end of the tail and should be examined in fresh preparations as well as after fixing and staining (eosin and methylene blue method, *vide infra*).

(b) **Tissues.**—Sections give poor results. The following method is recommended.

1. Prepare a thin film on a cover-glass with the tissue to be examined.
2. Before drying place the film for 30 minutes in a watch-glass containing a saturated solution of picric acid. Wash in water.
3. Stain for 6-12 hours in the following mixture, which must be freshly prepared.

| | | | |
|---|---|---|----------|
| Saturated aqueous solution of methylene blue, | - | - | 2 c.c. |
| Distilled water, | - | - | 4 " |
| 1 per cent. aqueous solution of eosin, | - | - | 8 drops. |

4. Wash in water, dehydrate rapidly in absolute alcohol and mount in balsam.

Laveran points out that in these investigations care must be taken to avoid mistaking for parasites the nuclei of nucleated red cells, the unstainable granulations of the red cells of certain fish, chromatin granules which become detached from the nuclei of red cells when the blood is badly fixed, and spherical granulations found in the red cells of various chelonians which stain deep violet by Laveran's method.



FIG. 379.—*Hæmogregarina ranarum*. $\times 1000$. Frog's blood.

2. *Hæmogregarina ranarum*.

Drepanidium ranarum.

According to Labbé two species of *Drepanidium*—*Drepanidium princeps* and *Drepanidium monilis* are found in the frog (*Rana esculenta*), but Laveran considers that these two forms really represent a single species, *Hæmogregarina ranarum*. The parasite can only be found during the summer and early autumn months.

(i) In the blood the adult parasite has the appearance of a vermicule, 12-15 μ long, which exhibits active and varied movement. In the resting state the anterior

extremity is rounded and the posterior pointed, but when in motion the anterior end also becomes pointed and so enables the parasite to penetrate the red cells; and further during movement one or two constrictions may be seen which beginning at the anterior end seem to slide towards the posterior end in a sort of peristaltic wave. The nucleus is situated about the centre of the parasite and at the posterior end there is often seen a structure of variable appearance which probably represents the débris of the red cell in which the Drepanidium developed or of the membrane which enveloped the intra-corporal parasite.

The young intra-corporal parasite is represented by a small nucleated cell with granular protoplasm, of variable shape, measuring 4–8 μ in its longest diameter.

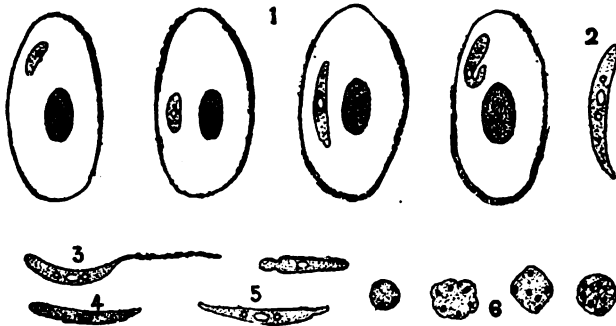

FIG. 380.—*Haemogregarina ranarum*. (After Laveran.) 1, Endo-corporal parasite; 2, free haemogregarine; 3, free haemogregarine with flagellum; 4, Haemogregarine fixed and stained; 5, Haemogregarine with constriction; 6, Reproduction forms.

As the parasite grows it becomes longer and is occasionally bent upon itself. It sometimes happens that there may be two parasites in the same red cell and leucocytes are also at times infected.

(ii) Reproduction forms are never found in the blood of the peripheral circulation: for the study of this phase of the life history films must be prepared from the spleen.

The parasites are numerous in the spleen even when very few can be found in the blood-stream. Reproduction forms consist of spherical or irregular cells 4–8 μ in diameter each containing two to six chromatin masses which stain deep violet with hæmatein. They are very similar to those of *Haemogregarina stepanowi* and represent an endogenous phase of reproduction (Laveran). According to Billet, exogenous reproduction by sporogony takes place in a leech of the genus *Helobdella*.

Methods of examination.—Blood is obtained by pricking a toe. In other details the technique is the same as described under *Haemogregarina stepanowi*.

3. *Haemogregarina lacertarum*.

Hæmatozoa are frequently found in the blood of lizards (*Lacerta viridis*, *L. agilis* and other species) and several species have been described by Danilewsky, Chalachnikoff and by Labbé,—*Haemogregarina lacertarum*, *Danilewskyia lacazei*, etc.

The young intra-corporal parasites are rounded or oval nucleated cells, but they afterwards elongate to form vermicules measuring about 10 μ long and more or less bent upon themselves. The parasite is set free by the destruction of the infected red cells and then shows active gregarinoid movement, sometimes accompanied by swellings and constrictions passing like waves along the body. Reproduction forms are not found in the blood of the peripheral circulation.

Methods of examination.—Blood can be obtained by cutting the tip of the tail. Films should be prepared and stained in the manner indicated above.

CHAPTER LIX.

THE INTRA-CORPUSCULAR HÆMATOZOA (*continued*).

Section III.—The genus *Piroplasma*,¹ p. 786.

Introduction.

1. *Piroplasma bigeminum*, p. 787.

Morphology and method of multiplication, p. 787. Methods of examination, p. 790. Immunity, p. 791.

2. *Piroplasma ovis*, p. 791. 3. *Piroplasma canis*, p. 791. 4. *Piroplasma equi*, p. 792. 5. *Piroplasma pitheci*, p. 793.

Section IV.—The genus *Theileria*, p. 793.

Theileria parva, p. 793.

BLOOD parasites of the genus *Piroplasma* (Patton and Laveran) are the cause of disease in cattle, sheep, horses, dogs, monkeys and possibly other animals.

The life history of the *Piroplasmata* is still only imperfectly understood. These parasites have been investigated by Koch and Klein, Nuttall and Graham-Smith, Kinoshita, Miyajima and others, but there is a want of agreement in the conclusions which these observers draw from their observations. There is, however, no doubt but that reproduction takes place both by *schizogony* and by *sporogony*. The schizonts, which may either be intra-corpuseular or free in the plasma, are amœboid and rounded or annular and by a process of budding give rise to rounded merozoïtes. The sporonts are intra-corpuseular and pyriform; they contain a nucleus and a blepharoplast and multiply asexually by longitudinal division in the blood; the forms resulting from division may remain attached by their pointed ends and undergoing further division give rise to star-shaped forms or rosettes (cf. p. 788).

Sporogony occurs in the alimentary canal of ticks (and perhaps also of some biting flies and mosquitos). According to Koch and Klein the sporonts which are set at liberty in the stomach of the insect can be differentiated into spherical *macrogametes* and cuneiform *microgametes*. The fertilized macrogamete (*zygote*) assumes a vermicular form, is motile and becomes club-shaped (*ookinete*).

Schaudinn, having noticed forms resembling Trypanosomes in animals infected with piroplasmata, put forward the hypothesis that the *Piroplasmata* should be grouped with the *Trypanosomata*. Miyajima observed large flagellated parasites similar to Trypanosomes in broth cultures sown with the blood of Japanese oxen affected with piroplasmosis (*P. parvum* [*Theileria*

¹ Synonyms:—*Hæmatococcus*, Babès; *Babesia*, Starcovici; *Pyrosoma*, Smith and Kilbourne; *Ixodioplasma*, Schmidt.

parva]), and this observation would tend to confirm Schaudinn's hypothesis; but Martini and Crawley have shown that the flagellated parasites seen by Miyajima are not *Piroplasmata* and that he was dealing with a double infection with two distinct parasites.

1. *Piroplasma bigeminum*.

Synonyms.—*Pyrosoma bigeminum*. *Babesia bigemina*.

Piroplasma bigeminum was the name given by Smith and Kilbourne to the parasite causing Texas fever in cattle. Babès had previously recorded the presence of the same hæmatozoon in the hæmoglobinuria of cattle associated with bacteria. The parasite has also been found in cattle suffering from hæmoglobinuria by Krogus and von Hellens in Finland, by Theiler in South Africa, in cattle in the Crimea affected with bovine malaria by Laveran and Nicolle, in Argentina in the disease of cattle known as *tristeza*, and in France in *le mal de brou*.

Symptoms and lesions.—Bovine piroplasmosis assumes either an acute, or a subacute or attenuated form. The acute form of the disease is most common in summer and is generally fatal: the temperature is raised, the urine is blood-stained and often contains albumen, the animal loses its appetite and is constipated, rumination is suspended, the blood becomes fluid and very pale-coloured, the animal emaciates and sometimes shows nervous symptoms (delirium, paralyses) and death takes place within a few days: in a small percentage of cases the animal recovers but relapses are of frequent occurrence.

The subacute form of the disease occurs more commonly in autumn and may be overlooked if the blood be not examined. There is no hæmoglobinuria, the fever is not so marked and the symptoms are generally far less severe.

Post mortem.—In animals dead of Texas fever sub-cutaneous ecchymoses are frequently found, the spleen is considerably enlarged, the perirenal tissues are oedematous and the kidneys enlarged and congested: patches of pulmonary hepatization are also sometimes found. Many of the red cells of the blood are enlarged and their number much diminished: the leucocytes are sometimes increased in number.

Ætiology.—The researches of Smith and Kilbourne, of Koch and of Theiler show that the disease is spread by ticks [*Boophilus annulatus*, *B. dugesi*, *B. decoloratus*, *Ixodes ricinus* and *Hæmaphysalis punctata*]. If all the ticks be removed from an animal before it is imported to a "clean" area, there is no risk of the animals in the latter contracting the disease. If ticks be taken from cattle suffering from Texas fever and placed on pasture where healthy beasts are grazing the latter soon show symptoms of the disease. The infection however is not conveyed by the tick which sucked the infected blood, but by the next generation, the parasite being transmitted from one generation of ticks to the next through the eggs (Smith and Kilbourne, Koch and others). Female ticks after feeding on infected cattle fall to the ground, lay their eggs and die: the larvæ hatched from these eggs will infect the animals upon which they become parasitic.

Morphology and method of multiplication.

1. Appearance in the blood.—In almost all cases Laveran and Nicolle have found the piroplasm within the red cells of the peripheral circulation in two chief forms:

1. Small, spherical or oval parasites. In stained preparations a mass of chromatin generally consisting of two unequal parts—the *nucleus* and *blepharoplast*—can be made out, situated as a rule near the periphery of the parasite. The smallest of these forms does not measure more than about 1μ in diameter. In the largest forms the nucleus elongates and divides into two, the two parts remaining attached for a time but afterwards separating and passing to the opposite ends of the parasite, after which the protoplasm divides. This represents the schizogonous—asexual—method of reproduction.

2. Pyriform parasites measuring $2.5-3.5\mu$ long and occurring in pairs, the narrow end of each being continuous with or contiguous to the tapering end of the other—hence the name *bigeminum*. Sometimes two entirely separate pyriform parasites are seen, in which case the pointed ends are often turned away from each other. In stained preparations two masses of chromatin



FIG. 381.—*Piroplasma bigeminum*. Blood from a cow. $\times 1000$.

can be seen in the larger end of the pear-shaped parasite—a rounded or oval nucleus and a blepharoplast—and the pointed end often shows scattered granules of chromatin.

In some of the free forms the pointed end of the parasite is prolonged into a pseudo-flagellum terminating in a point and staining with difficulty (Lignières, Fantham).

In the blood of the peripheral circulation the pyriform bodies are much more numerous than the round or oval forms. They represent sexual sporonts, development taking place in the stomachs of ticks (Doflein and Lühe).

In the blood, these pyriform parasites multiply asexually by longitudinal division, the chromatin dividing first: the infected red cell then contains two parasites: occasionally these two parasites divide again and the red cell then contains four pyriform parasites. The occurrence of four parasites in one cell may also be accounted for by supposing that it was originally infected with two parasites.

[Nuttall and Graham-Smith¹ from a prolonged study of the *living* parasite of canine piroplasmiasis and a comparative study of stained films of *P. canis*, *P. bigeminum* (*P. bovis*) and *P. pitheci* have established the fact that these three species multiply in precisely the same manner, namely by a peculiar process of budding by which a single amœboid body usually gives rise to two pyriform parasites.

[A free pyriform parasite enters a normal red blood corpuscle and after a time assumes a rounded form, grows, and becomes actively amœboid. The amœboid parasite then protrudes two symmetrical bud-like processes, which rapidly grow and become pear-shaped; the protoplasm of the parasite flows into these "buds" and the body consequently becomes smaller until it is represented by a minute mass to which the pyriform bodies are attached. This minute mass ultimately disappears and two mature pyriform parasites are left, joined for a time by a filament which finally ruptures leaving them free. After a variable length of time the parasites escape from the corpuscles

¹ *Journal of Hygiene* IV., V., VI., VII., and *Parasitology* I.

and the moment they escape attack fresh corpuscles and repeat the same method of multiplication.

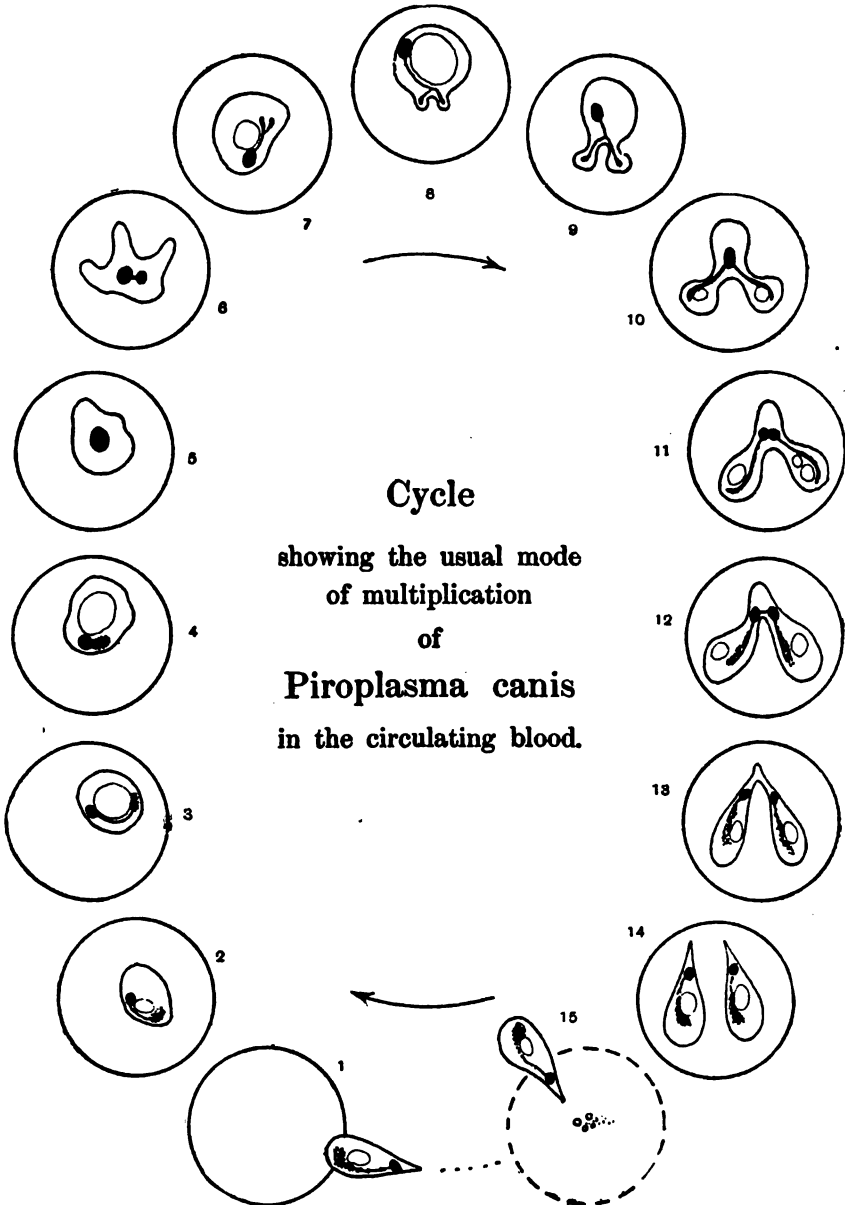

FIG. 382.—Cycle showing the usual mode of multiplication of *Piroplasma canis* in the circulating blood (Nuttall).

From the *Journal of Hygiene* (Cambridge University Press) by permission of Professor G. H. F. Nuttall, F.R.S.

[A pyriform parasite possesses a dense mass of chromatin, usually situated at the pointed extremity, and a secondary mass of loose chromatin extending

towards the blunt end. When the parasite becomes rounded the chromatin gradually fuses into one mass, which subsequently divides and forks in a peculiar manner so as to give rise to a Y-shaped chromatin figure; the two processes are thin, and protrude into the two small buds and indicate coming division. As the buds grow in size, the main mass of chromatin divides and all the chromatin passes into the two pyriform bodies.

[Moreover an amoeboid intra-corpuseular parasite may divide in the amoeboid stage into two parasites and the two daughter cells give rise independently and perhaps simultaneously, to two pairs of pyriform parasites in a similar manner to that described.]

2. Appearance in films prepared from the spleen.—Free parasites are much more numerous in the spleen than in the blood of the peripheral circulation. The small rounded or oval forms predominate and undergo multiplication—this organ being the main site of endogenous reproduction (schizogony). These small forms being endowed with powers of amoeboid movement are able to penetrate the red cells (Laveran and Mesnil).

Appearance in ticks.—The changes taking place in *Piroplasma bigeminum* in the stomachs of ticks after the latter had fed on infected animals has been followed by Koch. As has already been stated it is in the stomachs of certain species of ticks that the piroplasma undergoes sexual (sporogonous) multiplication. About 12 or 20 hours after the infected meal it is not uncommon to find the pyriform parasites, which have now left the red cells, changed into spherical bodies each having twelve to twenty delicate straight prolongations arranged round it like rays round a star. These ray-like processes subsequently disappear while the spherical bodies increase in size and later large club-shaped structures (*ookinetes*) are seen, not only in the digestive tube but also in the eggs.

Methods of examination.

Microscopical examination.—The blood from an infected animal may be examined either in the fresh condition or after drying.

Laveran and Nicolle give the following directions:

1. Fix the films at 110° C. for a few minutes and then in a saturated aqueous solution of perchloride of mercury for 1 minute.
2. Stain for 1–2 hours in Laveran's eosin-methylene-blue solution, wash, treat with tannin and proceed as described at p. 772. Before mounting in balsam, make certain that the preparation is not stained too deeply: should this be the case, decolourize in absolute alcohol. The nuclei of the parasites should be stained violet-red.

Cultures.—A culture of *P. bigeminum* may be obtained if some blood rich in parasites be sown in citrated blood or in serum rich in hæmoglobin and incubated at 37° C. (Lignières). Growth appears in about a fortnight. The piroplasmata become rounded, leave the red cells and lose their nuclei: then the nucleus is formed anew and divides into from two to five small spherical bodies surrounded by protoplasm, constituting spores. These in their turn give origin to new spherical bodies. Pyriform bodies are never seen in cultures.

Experimental inoculation.—Cattle are the only domestic animals susceptible to infection. Infection of cattle can be produced experimentally by inoculating infected blood beneath the skin, into the muscles or into the peripheral circulation. The success of the experiment will depend upon the number of parasites in the blood inoculated; when it is rich in parasites a dose of 0.1–0.05 c.c. will be sufficient to produce infection, but it may be necessary to use as much as 1, 2 or even 10 c.c.

Cattle cannot be infected by the alimentary canal.

Immunity.

Bovine piroplasmosis does not recur in the same animal and cattle which recover from a first attack of the disease are permanently immune. The serum of such animals has neither therapeutic nor prophylactic properties (Nicolle and Adil-Bey). Lignières obtained promising results by vaccinating cattle with an attenuated piroplasma.

In the blood of immunized animals the piroplasma assumes a different form (rings and small rods) from that presented by the parasite in animals suffering from the disease. The inoculation of blood containing these parasites into a healthy animal produces an illness which may terminate fatally (Theiler).

2. *Piroplasma ovis*.

Synonym.—*Babesia ovis*.

The piroplasma infecting sheep was first described by Babès in the disease known as *Carceag*, in Roumania. It was subsequently found by Bonome in an epizootic near Padua and has been studied by Laveran and Nicolle (in an epizootic in Constantinople) and by Motas (in Roumania). The parasite has also been found in Bulgaria, Italy, France, South Africa and India.

Sheep piroplasmosis occurs in two forms—a severe and fatal form (with anæmia, prostration and hæmoglobinuria) and a mild form often not diagnosed which terminates in recovery. One attack confers immunity. In sheep dead of piroplasmosis the tissues are œdematous, the blood pink and fluid, the spleen and the lymphatic glands enlarged: numerous parasites will be found in the blood and spleen.

Appearance in the blood.—The parasites measure 1–1.5 μ in diameter; they are rounded or elongated, non-pigmented, generally contained within the red cells, and have a rounded karyosome situated, as a rule, near the periphery. Some of the intra-corpuscular parasites will be seen to be actively multiplying: the karyosome elongates and then splits into two, and division of the protoplasm follows. The double and pyriform parasites are as a rule free but may occasionally be found in the red cells. Generally speaking there is not more than one parasite in a red cell.

Appearance in films from the spleen.—The parasites are more numerous in the spleen than in the blood of the peripheral circulation but are similar in appearance, though they are often a little larger and dividing forms are more common.

Microscopical examination.—The technique is the same as in the case of *Piroplasma bigeminum*.

Ætiology.—*Piroplasma ovis* is transmitted by the sheep tick (*Rhipicephalus bursa*). As in other piroplasmoses it is the progeny of the ticks which have sucked the blood of infected animals which transmit the disease. These daughter ticks are only capable of inoculating the parasite when they have reached maturity (Motas). As a rule one attack confers immunity.

3. *Piroplasma canis*.

Canine piroplasmosis is a common disease in France (Leblanc, Nocard): it occurs also in Senegal (Marchoux), in South Africa (Theiler: malignant jaundice, biliary fever of dogs), in Tonkin (Mathis), in Japan (Kinositha), etc.

Ætiology.—Canine piroplasmosis is propagated by dog ticks [(*Hæmaphysalis leachi* in Africa: *Rhipicephalus sanguineus* in India)] (Nuttall, Lounsbury). The disease is transmitted by the offspring of those ticks which have sucked the blood of infected animals but only when the daughter ticks are full-grown. A first attack

confers immunity. The blood of immunized animals contains the parasite and is capable of setting up a fatal disease in a non-immune animal.

Appearance in the blood.—The parasites, numerous in the acute form, are somewhat rare in the chronic form of the disease. This species, like *P. bigeminum*, is found in the blood in two forms :

1. The round, amœboid forms—sometimes small and free, sometimes discoid or annular—contained in the red cells divide by budding (Kinositha) : the annular forms consist of a ring of protoplasm enclosing a central vacuole ; the protoplasm contains a chromatin mass divided into *nucleus* and *blepharoplast* (Lühe).

2. The pear-shaped forms appearing particularly during the second period of the infection correspond, according to Kinositha, to sexually differentiated sporonts ; but in the blood they may multiply by binary longitudinal division. Some parasites have one or two flagella (Breinl, Kinositha). The pyriform bodies are free or intra-corpuseular : some of the red cells contain as many as eight parasites.

[Cf. Nuttall and Graham-Smith's description (p. 788).]

Development in the tick.—Christophers, following the development of the parasite in *Rhipicephalus sanguineus*, describes a sporogonic development as taking place in the alimentary canal of the tick resulting in the formation of vermicular elements which pass into the ovaries of the adult tick and into the embryonic tissues of the nymph, there forming a rounded mass, or *zygote*, which in turn gives origin to sporoblasts and these to sporozoites.

Cultures.—*In vitro*, Kleine has observed modifications of the parasite without true multiplication, in diluted defibrinated blood. The blood is collected from infected dogs some hours before death, defibrinated and mixed with an equal volume of normal saline solution and incubated at 25° C. to 27° C.

Under these conditions, club forms with radiating processes are seen after about 12 hours similar to those described by Koch in the case of *P. bigeminum* : these bodies exhibit very distinct amœboid movement. They assume a rounded form towards the second day, the radiating processes become obliterated and the parasites then themselves disappear.

Methods of detection.—The technique is similar to that for *Piroplasma bigeminum*. Nocard advises fixing the blood films in absolute alcohol and staining with carbol-thionin.

To facilitate the diagnosis in cases in which the parasites are few in number and where microscopical examination has failed to reveal their presence, Nocard recommends injecting into a young dog sub-cutaneously or intravenously, 5–10 c.c. of the blood of the dog under examination. If it be a case of piroplasmiasis the inoculated animal as a rule develops an acute piroplasmiasis, and after the third to the fifth day the parasites multiply in its blood.

4. *Piroplasma equi*.

Equine piroplasmiasis is a common disease in the Transvaal, where it has been studied by Theiler : it is very similar to "red-water" in cattle. The parasite was discovered by Laveran ; it is smaller than *P. bigeminum*, and as generally seen is round or oval, pyriform bodies being very rare. The disease is transmitted by a tick, *Rhipicephalus evertsi* (Theiler).

Piroplasma equi has been found in Madagascar by Thiroux in horses suffering from a chronic disease known by the inappropriate name of *Osteomalacia*.

Equine piroplasmiasis is a common disease in India (Patton), where it is said to be transmitted by biting flies or mosquitos (Williams).

Imported animals suffer from the disease but animals born and bred in tick-infested countries have an acquired or transmitted immunity (Theiler). The blood of an immune animal contains the parasite and will infect non-immune animals.

5. *Piroplasma pitheci*.

[A true piroplasmosis occurs in monkeys (*Cercopithecus*) in Uganda and was first observed by P. H. Ross. The manner in which the disease is transmitted is as yet unknown (Nuttall).

[The appearance of the parasite in the blood and the mode of division is the same as in *P. bigeminum* and *P. canis* (p. 788) (Nuttall and Graham-Smith).]

SECTION IV.—THE GENUS THEILERIA.

[*Theileria parva*.¹]

[Rhodesian fever of cattle (East coast fever, tropical piroplasmosis) is due to an infection with a blood parasite which resembles the parasite of red-water in that it is transmitted by ticks (*Rhipicephalus appendiculatus* and *R. simus* [and other species of the same genus]) but differs from it both in morphology and in the fact that it cannot be transmitted by inoculation.]

According to Theiler, Rhodesian fever, which is the worst of all cattle diseases, may assume one of two clinical types: an acute rapidly fatal form accompanied by fever, blood-stained diarrhoea, intense jaundice and muscular twitchings, and a chronic form characterized by a transitory attack of fever and jaundice.

Appearance of the parasite in the blood.—In the blood of infected cattle three forms of the parasite are found. In the acute form of the disease the parasites assume a ring or bacillary form and not infrequently the one may be seen to change into the other: they exhibit amœboid movement, and a small mass of chromatin can be made out. In the chronic form of the disease the parasite appears as a non-motile punctiform mass of chromatin.

The parasites are very abundant in the blood: in the acute form of the disease 90 per cent. of the red cells may contain them. Generally a few red-water parasites are also seen, in which cases the animals are suffering from a double infection.

Appearance in ticks.—In ticks, Koch observed starred and rounded forms, similar to those seen in the case of *Piroplasma bigeminum*.

Microscopical examination.—The technique is the same as for *P. bigeminum*.

Cultures.—Dschunkowsky and Lühs have observed multiplication of the parasite in serum stained with hæmoglobin obtained from animals suffering from the disease.

Experimental inoculation.—The disease cannot be transmitted by inoculation: even when the blood inoculated is swarming with parasites the animal does not contract the disease. Animals which have recovered from an attack of the disease are immune: the parasite cannot be found in the blood and ticks fed on the blood do not become infected.

Theiler has recently described a parasite morphologically similar to the foregoing but feebly pathogenic to cattle and very easily inoculable. This parasite is known as *Piroplasma mutans* (Theiler).

Piroplasma mutans is very often found in cattle in association with *P. bigeminum*.

¹[This parasite is sometimes regarded as belonging to the genus *Piroplasma*—*Piroplasma parvum*, *Babesia parva*—but Bettencourt, França and Borges consider that it differs so widely from the parasites of that genus that it should be separated from them and for that reason created the new genus *Theileria*. Nuttall is of the same opinion.]

CHAPTER LX.

THE GREGARINIDA.

[THE Gregarinida are an Order of the Sub-division Telosporidia of the Sporozoa (see p. 760).]

The Gregarines are unicellular parasites which live in the gut or body cavity of the invertebrata and especially in the articulata. [They are wholly or in part intra-cellular parasites inhabiting usually the epithelial cells of the host, but never the blood cells.]

In the adult form [*Trophozoïte*] they are more or less elongated structures measuring from 10–20 μ to 16 mm. and consist of a continuous outer membrane or cuticle (*epicyte*) containing an *ectoplasm*, *endoplasm* and a *nucleus*. The body of a Gregarine may be homogeneous or segmented hence the two groups *monocystida* and *dicystida*. In the dicystida the segments are generally unequal in size; the anterior segment or head is known as the *protomerite* and in some cases possesses an organ of attachment, the *epimerite*; the posterior segment or body known as the *deutomerite* contains the nucleus.

The cuticle or epicyte frequently shows longitudinal striæ composed of myonemes. Transverse striation is less commonly seen.

The cytoplasm consists of an ectoplasm and endoplasm the latter as a rule containing a large number of chromatic granules.

The nucleus, usually single, is spherical or oval and has several nucleoli.

Those Gregarines which have an epimerite remain attached for some time to an epithelial cell of the host then by rupture of the junction between the epimerite and protomerite the parasite becomes detached and is free.

The Gregarines exhibit movement, sometimes of translation and sometimes of flexion: movements of flexion are limited to the deutomerite and are accompanied by active contractions of the protoplasm.

At a given moment in its life history the Gregarine becomes encysted, whether it has had previous association with another of its kind or not.

In this association which is not a conjugation but merely a juxtaposition two individuals become attached together—[syzygy]—either by their anterior ends as is the case with but few exceptions in the Monocystids or by opposite ends as in the Dicystids. [The two associated individuals then generally become surrounded by a common membrane.] In *Gonospora longissima* Caullery and Mesnil have shown that the septum between the two associated individuals is destroyed and that the protoplasm of the parasites fuses. Occasionally a number of individuals become attached end to end forming a chain.

[After encystment¹ the nuclei of the two *trophozoïtes* or sporonts or *gameto-*

[¹ See Professor Minchin's description in *A Treatise on Zoology* edited by E. Ray Lankester, London, 1909.]

cytes undergo karyokinetic division and the daughter nuclei pass to the surfaces of the encysted parasites. The cytoplasm of each cell divides into an equal number of segments and the segments collect around the nuclei: each of these small nucleated masses of protoplasm is known as a sporoblast or *gamete*. A certain amount of cytoplasm—known as the *cystal residuum*—remains unused and serves for the nutrition of the gametes. The cuticle of each gametocyte now dissolves; the gametes exhibit active movement and conjugate in pairs—a gamete from one gametocyte conjugating notably with a gamete from the other. After uniting each pair of gametes becomes a *zygote*. The zygote becomes oval and secretes a chitinous envelope, forming a *sporocyst*. Within this cyst the nucleus of the zygote—or as it is now termed the *sporoplasm*—divides into two, then into four and finally into eight nuclei which take up an equatorial position and become surrounded each by a part of the protoplasm of the sporoplasm. In this way the *sporozoite* or falciform body is formed. In *Monocystis* the fully formed sporozoite has a more or less boat shape and resembles a diatom of the genus *Navicella*, hence the name *Pseudonavicella* by which Gregarine spores are generally known.

[The spores of *Monocystis* do not appear to be able to develop further in the earthworm but require to be transferred to a new host. It is probable that infection of a new host takes place by way of the alimentary canal, the digestive juices dissolving the wall of the sporocyst and setting free the sporozoite which is actively motile and able to bore its way through cells and tissues.

[When Gregarines become encysted without pairing the gametocyte breaks up into gametes at once. In these cases the spores are smaller than those produced from zygotes.]

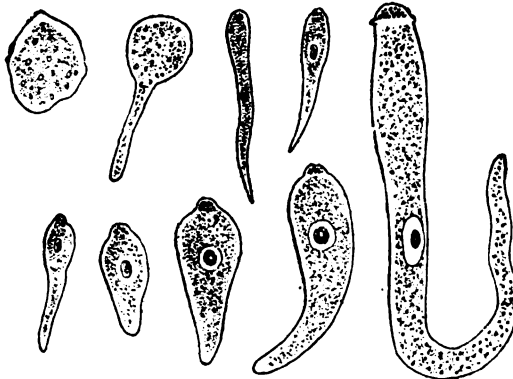

FIG. 383.—Gregarine of the lobster. On the right, the adult form of the parasite; on the left, the different shapes assumed by the protozoon in passing from the young amoeboid to the adult form. (After V. Beneden.)

From the observations of Caullery and Mesnil it appears that in some Gregarines multiplication takes place by schizogony, the intra-cellular stage of the life history being prolonged. In *Gonospora longissima*, a parasite of *Dodecaceria concharum*, the sporozoite set free from the spores in the gut of the Annelid host passes into one of the epithelial cells lining the gut and in this cell gives origin to a small spherical nucleated body which increasing in size becomes the trophozoite; and this multiplying by division divides into six or eight crescent-shaped merozoites arranged side by side to form a

barrel-shaped structure. These crescent-shaped merozoites then escape from the cell host and become sporozoites which pass into the body cavity of the animal.

Among the best known Gregarines are *Porospora gigantea* (parasitic in the intestine of *Astacus gammarus*); *Gregarina blattarum* (parasitic in the intestine of *Blatta orientalis*); *Monocystis tenax* (a parasite of the earthworm); *Lankesteria ascidie* (a parasite of *Ciona intestinalis*).

Technique.—For the examination of the Gregarinida, Wasielewski recommends osmic acid or a saturated solution of perchloride of mercury as a fixing agent, and safranin, picro-carmin, gold chloride or silver nitrate as a stain. Bertarelli advises fixing in acid perchloride or in Flemming's solution and staining in iron-hæmatoxylin or Delafeld's hæmatoxylin.

CHAPTER LXI.

PARASITES OF THE GENUS LEISHMANIA.

1. *Leishmania donovani*, p. 797. 2. *Leishmania infantum*, p. 800. 3. *Leishmania tropica*, p. 802. 4. Other species of *Leishmania*, p. 802.

1. *Leishmania donovani*.

Synonym.—*Piroplasma donovani*.

IN 1900 Leishman demonstrated [in the spleen of a man who had been invalided for and who died of dum-dum fever¹] certain parasitic forms which he suggested might be Trypanosomes. In 1903 Donovan found the same parasite in the smears of the spleen taken from patients dying of a similar disease in Madras, and Bentley subsequently found them in patients suffering from Kala Azar, a very fatal disease found in Bengal and Assam.

The Leishman-Donovan parasite was originally classified by Laveran and Mesnil with the piroplasmata: Ross however created for it a new genus—*Leishmania*. Marchand and Ledingham consider that the parasite is a Trypanosome while Rogers [and Patton] group it with the genus *Herpetomonas*.

Methods of detecting the parasite. Its appearance in the tissues.—The parasite occurs characteristically in the endothelial cells of the blood and lymphatic vessels: it is present in very large numbers in the spleen, liver and bone marrow, and is also found in the lungs, kidneys, mesenteric glands and in the ulcers in the large intestine. In the peripheral blood it occurs in small numbers within the polymorpho- and mono-nuclear leucocytes and very occasionally in the red cells. Its presence in the blood is very likely to be missed so that several preparations should be examined before coming to a negative conclusion: in the last stage of the disease, however, and during febrile attacks the parasite may be present in large numbers in the bloodstream (Donovan).

Blood-films should be prepared and examined in the first instance and should the parasite not be found the spleen may be punctured and films stained. Puncture of the spleen, however, is always a risky proceeding: it is better to puncture the liver. Use a quite dry, sterile syringe with a fine needle: the results are more satisfactory if no blood be drawn. Expel the material in the needle on to slides, spread films, dry, stain with Giemsa's or Leishman's stain and examine with an oil-immersion lens.

¹ [Dum-dum fever is so called from Dum-dum an unhealthy cantonment near Calcutta.] The disease is a severe form of cachexia accompanied by fever, anæmia, hypertrophy of the spleen, wasting of the muscles and diarrhœa. It used also to be described as tropical splenomegaly but is now known to be the same disease as Kala Azar.

The parasites are almost always intra-cellular, generally in large endothelial cells, sometimes in leucocytes, and occasionally in the red cells of the blood. A large number of parasites are often found in one cell and as many as 50 to 200 have been found within a rounded amorphous mass of tissue representing probably a disintegrated cell.

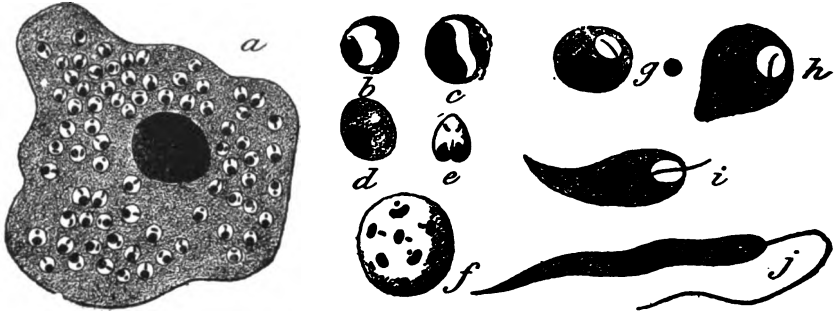

FIG. 384.—*Leishmania donovani*. (After Gulart.) a, *Leishmania* in a macrophage; b, c, d, parasites in the spleen; e, longitudinal division; f, multipartition; g, h, i, j, cultivation forms.

Leishmania donovani occurs as a small rounded or oval organism measuring 2–4 μ in diameter. When stained by Romanowsky's or Leishman's stain it is found to possess a large spherical poorly-staining nucleus, and a short rod-shaped deeply-staining blepharoplast arranged perpendicularly or tangentially to the nucleus; occasionally a prolongation in the form of a tail is seen, attached perpendicularly to the blepharoplast; this probably represents the remains of a flagellum (fig. 384 d). Reproduction is generally by simple longitudinal division (fig. 384 e), occasionally by multiple fission—in which case the mother-parasites are larger and spherical and show several chromatin masses arranged in couples (nucleus and blepharoplast) around which the protoplasm segments (fig. 384 f).



FIG. 385. *Leishmania donovani*. $\times 1000$. Smear from spleen from a case of Kala Azar (Leishman's stain).

[**Sections.**—For the recognition of the parasite in sections of tissues the following methods are recommended (Nattan-Larrier).

Fixation.—Any of the following fixatives are good provided the pieces of tissue be small. (8 \times 4 \times 3 mm.)

(i) Acid perchloride.

(ii) Saturated aqueous solution of perchloride.

(iii) Alcohol. Leave the tissue in 70 per cent. alcohol for 3 hours, then in 80 per cent. for 3 hours and finally in 90 per cent. (iv) Formalin. The tissue may be placed in 2 per cent. formalin for 3 hours and then passed through alcohol as above.

Embed in paraffin.

Staining.—The best results are obtained with the following procedures:—

(i) Carbol-thionin.—Stain for 30 min. Wash in distilled water. Dehydrate rapidly in absolute alcohol. Differentiate in oil of cloves and afterwards in absolute alcohol. Clear in xylol. The nuclei are shown very prominently.

(ii) Kernschwarz and carbol-thionin.—Stain in Kernschwarz for 15 min. Wash well in distilled water. Stain in carbol-thionin as above (i).

(iii) Alum-carmin and carbol-thionin.—Stain in the carmin solution for 24 hours. Wash for 30 mins. Stain for 30 min. in carbol-thionin. Differentiate in oil of cloves until the section has a red-violet tint and the protoplasm of the cells a pinkish colour. Pass rapidly through alcohol and clear in xylol.]

Appearance in cultures.—Rogers found that the parasites multiplied in blood from the spleen withdrawn by splenic puncture and also in human blood containing a small amount of a sterile 5 per cent. solution of sodium citrate made slightly acid with citric acid. The most suitable temperature is 22° C. though multiplication also takes place at 27° C. Sub-cultures do not grow.

In acidulated citrated blood growth is rapid: after incubating for about 48 hours a few flagellated forms are visible; some of these have the shape of a grain of barley while others are much longer. Each parasite has a nucleus and a blepharoplast, the latter giving origin to the flagellum: the anterior flagellated extremity is rounded, the posterior pointed: there is no undulating membrane.

Leishmania donovani can also be grown on *Novy* and *MacNeal's medium*.

Novy and MacNeal's medium:

| | | | | | | | |
|--|---|---|---|---|---|---|-----------|
| Maceration of beef, | - | - | - | - | - | - | 1000 c.c. |
| Agar, | - | - | - | - | - | - | 20 grams. |
| Peptone, | - | - | - | - | - | - | 20 " |
| Salt, | - | - | - | - | - | - | 5 " |
| Normal solution of sodium bicarbonate, | - | - | - | - | - | - | 10 c.c. |

Dissolve in tubes, sterilize and to two parts of the alkaline agar add 1 part defibrinated rabbit blood.

Nicolle's medium is easier to prepare and gives better results.

Nicolle's medium—[N.N.N. medium]:

| | | | | | | | |
|--------|---|---|---|---|---|---|----------|
| Water, | - | - | - | - | - | - | 900 c.c. |
| Salt, | - | - | - | - | - | - | 6 grams. |
| Agar, | - | - | - | - | - | - | 16 " |

Dissolve, distribute in tubes, sterilize and add to the medium in each tube after liquefying and cooling to 40°-50° C. one-third its volume of rabbit blood obtained by cardiac puncture. Slope the tubes for twelve hours, incubate at 37° C. for five days to test the sterility of the medium and then keep them at the ordinary temperature of the laboratory for a few days before sowing them. [The tubes should be sealed to prevent evaporation.]

[Sub-cultures can be obtained on this medium (Row).]

[Laveran and Pettit's medium:

| | | | | | | | |
|-----------------------|---|---|---|---|---|---|----------|
| Peptone (Chapoteaut), | - | - | - | - | - | - | 2 grams. |
| Salt, | - | - | - | - | - | - | 6 " |
| Water, | - | - | - | - | - | - | 900 c.c. |

Dissolve. Distribute in quantities of 15 c.c. in small Roux flasks. Sterilize. Add to each flask an equal volume of defibrinated rabbit's blood. The medium should form a shallow layer on the bottom of the vessel.

[This liquid medium is useful for growing rich cultures such as are required for animal inoculation.]

Ætiology.—The life history of *Leishmania donovani* outside the human body is still imperfectly known. It may be conjectured that kala azar is propagated by a biting insect. Patton from recent experiments is inclined to incriminate the bug, *Cimex rotundatus*: after feeding these insects on persons suffering from the disease Patton found in them flagellated forms similar to those seen in cultures.

[Patton has now been able to follow the complete development of *Leishmania donovani* in both the European and Indian bed bugs (*Cimex lectularius* and *C. rotundatus*). The insects were infected by allowing them to feed upon a case of kala azar in whose blood the parasites were present in large numbers. The

development, as in the case of *Herpetomonas*, takes place in three stages—a pre-flagellate, a flagellate and a post-flagellate. The parasite is ingested with the white cells of the blood and passes to the mid-gut of the bug where it elongates into flagellated forms similar to those seen in cultures and often forms masses of rosettes. About the seventh to the ninth day after a *single* feed the mature flagellated parasites undergo a further developmental process resulting in the rounding up of the parasite into its post-flagellate form. The latter appears on about the eighth day and the changes are completed by the twelfth day. The post-flagellate forms resemble the pre-flagellate forms in shape only and differ from the latter in being slightly larger and in presenting very different staining reactions—the protoplasm instead of staining blue as in the pre-flagellate forms stains pink.

[In order to observe these changes the insects must have only one feed. If fed during the flagellating stage the parasites are destroyed. In several of the bugs which were fed once only Patton observed an enormous multiplication of the parasites and masses of rosettes were seen.

[Patton is of opinion that the post-flagellate forms gain entrance to a new host by being regurgitated from the gut while the bug feeds, for the whole of the multiplicative stage takes place in the mid-gut.

[Donovan has failed to get the same results as Patton and from his observations is inclined to suspect a tick (*Conorrhinus rubrofasciatus*).]

On the other hand, Manson points out that the organisms are present in small numbers in the peripheral blood while they abound in the ulcers on the skin and intestinal mucous membrane: infection by contamination with infected excretal matter might therefore be of great importance in the propagation of the disease and non-biting flies might possibly play a part.

Experimental inoculation.—[Until recently] all attempts to inoculate the disease into vertebrate animals have failed.

[Patton inoculated a white rat intra-peritoneally with 3 c.c. of an emulsion of the spleen from a case of Indian kala azar. Fifteen days later a second inoculation of 1 c.c. was given. The rat died two hours after the second inoculation. *Post mortem* the liver and spleen were considerably hypertrophied and contained large numbers of typical parasites.

[Laveran inoculated into the peritoneal cavity of a mouse 0.5 c.c. of an emulsion of bone marrow and spleen from an heavily infected dog (*L. donovani*). A month later the animal was killed. *Post mortem* there was a slight peritoneal exudate and the spleen was four to five times its normal size. Numerous parasites were found in films made from the internal organs.]

2. *Leishmania infantum*.

Cathoire was the first to notice a peculiar disease in Tunis which was clinically like kala azar but only affected young children and especially infants 1–2 years old, never being seen in children more than 6 years of age. Cathoire's observations were confirmed by Nicolle and Cassuto. A similar disease has been described as occurring in Italy—Infantile splenic anæmia (Pianese and others), [and in Greece—Ponos].

This disease is due to a parasite microscopically identical with *Leishmania donovani* but from which it differs in its cultural characteristics and in the results obtained on inoculation into animals. Nicolle has provisionally classed it as a new species; *Leishmania infantum*.

[Leishman gives the following as the differences between Mediterranean and Indian kala azar.

[“ 1. The infantile attacks almost exclusively young children, while the Indian is met with at all ages. 2. Certain differences of symptomatology have been

described. 3. Cultures of the parasites are readily obtainable upon Novy and MacNeal's medium in the case of *L. infantum*, and are easily sub-cultivated, while in the case of *L. donovani* cultures on this medium are as a rule unsuccessful and sub-cultures cannot be made. On the other hand cultures of *L. donovani* succeed in citrated splenic blood and usually fail in the case of *L. infantum*. 4. Inoculation of the spleen parasites into dogs and monkeys reproduces the disease in the case of *L. infantum* and fails in *L. donovani*. 5. A spontaneous infection of dogs has been found in the endemic areas of infantile kala azar but no such infection of dogs has been encountered in India."]

Detection in the tissues.—The parasite is invariably found in the material obtained by puncture of the spleen; the organisms are less numerous in material obtained by puncture of the liver, and in the majority of cases they cannot be found in the peripheral blood (Nicolle).

Cultures.—The organism will not grow in Rogers' medium (citrated blood), but cultures are easily obtained in Novy-MacNeal's or in Nicolle's medium (*vide ante*).

When sown in Nicolle's medium and incubated at 22° C. growth begins about the end of the first week and reaches its maximum on the twelfth day. The organism will be found alive at the end of three months and sub-cultures can be sown indefinitely (Nicolle).

Inoculation experiments.—Dogs can be infected by inoculating them either into the peritoneal cavity or into the liver with an emulsion of an infected spleen: the distribution of the parasite is the same as in man. The disease usually runs a benign course though several animals have died of the disease after inoculation.

In monkeys (*Macacus sinicus*, *M. cynomolgus*), inoculation gives rise to a disease more severe than in dogs and running a more rapid course.

When mice and guinea-pigs are inoculated into the peritoneal cavity with an emulsion of tissue from dogs containing a large number of organisms, the latter multiply in the peritoneal cavity but do not become generalized and give rise to no symptoms of disease (Laveran and Pettit). [Nicolle, Yakimoff and Kohl-Yakimoff obtained a generalized infection in white mice by the inoculation of emulsions of infected tissues or of cultures into the vein of the tail. *Post mortem* the spleen was hypertrophied and parasites were found in the spleen and liver.

[Dogs can be infected with infected dog tissue by intra-peritoneal inoculation (Senevet).]

According to Nicolle cultures are not virulent; Novy however has been able to infect dogs with cultures [and *vide supra*].

Etiology.—Nicolle believes that infantile kala azar is of canine origin. [Gabbi, and Patton however do not consider that infantile kala azar is of canine origin. Patton believes that the bed bug *Cimex lectularius* will be found to act as the insect porter of the disease seeing that *L. donovani* develops equally in *C. lectularius* and in *C. rotundatus*.] In Tunis, dogs suffer from a natural leishmaniosis but though the spontaneous disease is more benign than the inoculated disease Nicolle believes that the parasite is the same in the two cases. In several cases where children were attacked they had played with dogs which were obviously ill.

[Naturally infected dogs have been found also in Algiers (Ed. and Et.



FIG. 386.—*Leishmania infantum*. ×1000.
From a culture (Leishman's stain).

Sergent) and in Greece (Cardamatis). The percentage infected is much greater in the summer months than in winter. A cat was also found suffering from the spontaneous disease in Algiers (Ed. and Et. Sergent, Lombard and Quilichini).]

3. *Leishmania tropica*.

Syn.—*Leishmania furunculosa*.—*Helcosoma tropicum*.

The endemic granulomata of warm countries (Oriental sore, Aleppo boil, Delhi boil, and known also by innumerable other local names) are caused by a protozoan organism, discovered by Wright (*Helcosoma tropicum*) and by Marzinowsky and Bogrow, and belonging to the genus *Leishmania*.

Appearance in the tissues.—In the tissues the parasite is indistinguishable from the parasite of kala azar: it occurs within the cells, generally in the macrophages, endothelial cells and mononuclear leucocytes, but occasionally in the polymorphonuclear leucocytes and in cells of the connective tissue.

Appearance in culture.—In cultures *L. tropica* is distinguished from *L. donovani* by the early division of the flagellum (some cells have two flagella at their anterior end) and by the greater length and more marked flexuosity of the flagellum (Nicolle and Sicre).

[Row found the following differences between *L. donovani* and *L. tropica* when the two parasites were grown on Nicolle's medium at the same time.

1. The growth of *L. tropica* is much more luxuriant than that of *L. donovani* over the same period. 2. *L. tropica* is distinctly larger than *L. donovani*. 3. The posterior extremity of *L. donovani* is distinctly more pointed than that of any other. 4. There is a far larger number of fine vacuoles in the fully formed flagellates of *L. donovani* than in *L. tropica*. 5. *L. tropica* is characterized by the appearance of fine chromatin particles distributed in the body of the parasites just as *L. donovani* is hollowed out by the presence of fine vacuoles. These last two however may be purely accidental.]

Experimental inoculation.—The parasite of Oriental sore can be inoculated into man and also into monkeys (*Macacus sinicus*) (Marzinowsky).

Ætiology.—*Leishmania tropica* forms flagellates in bugs (Wenyon, Patton). Patton has no doubt but that in Cambay the bug *Cimex rotundatus* is the only transmitter of the disease in spite of the fact that his attempts to prove the hypothesis experimentally have failed. Wenyon states that in Bagdad bugs are not sufficiently numerous to account for the prevalence of the disease there and concludes that the house fly is sometimes the transmitting agent but more usually one of the mosquitoes or the sand fly *Phlebotomus*.]

[The disease encountered in South America and known as *Espundia* is due to a parasite closely resembling *L. tropica* but as there are certain differences between the two organisms Laveran and Nattan-Larrier prefer at present to regard the South American parasite as a variety of the latter—*L. tropica* var. *americana*.]

Other species of *Leishmania*.

Three other species of *Leishmania* have been described as occurring in man but the existence of these parasites and their identity are still matters of doubt. One of them was described in Typhus fever by Lewaschew and by Gotschlich [but see p. 847]: the second, in dengue by Graham: and the third by Wilson and Chowning in the spotted fever of the Rocky Mountains, a disease transmitted by a tick (*Dermacentor occidentalis*); Stiles and Ricketts however have failed to confirm this last discovery.

CHAPTER LXII.

THE FLAGELLATA.

Section I.—The Trypanosomata.

Introduction.

1. *Trypanosoma lewisi*, the rat trypanosome, p. 805.
Trypanosomes in rodents other than rats, p. 808.
2. *Trypanosoma equiperdum*, the trypanosome of Dourine, p. 809.
3. *Trypanosoma brucei*, the trypanosome of Nagana, p. 811.
African Trypanosomiases related to Nagana, p. 813.
4. *Trypanosoma evansi*, the trypanosome of Surra, p. 814.
5. *Trypanosoma equinum*, the trypanosome of Mal de Caderas, p. 814.
6. *Trypanosoma theileri*, the trypanosome of Galzietke, p. 816.
7. The trypanosomes of Sleeping sickness, p. 816.
Trypanosoma gambiense, p. 816.
Trypanosoma rhodesiense, p. 820.
8. *Trypanosoma cruzi*, p. 822.
9. Trypanosomes in birds, p. 823.
10. Trypanosomes in cold-blooded vertebrata, p. 824.

Section II.—*Trichomonas vaginalis*, p. 825.

Other species of *Trichomonas*, p. 826.

Section III.—*Lambia intestinalis*, p. 827.

THE Flagellata are free Protozoa characterized by the presence of one or more flagella (which are totally different structures from bacterial flagella) and sometimes by an undulating membrane. Numerous parasites of man and the lower animals belong to this group.

SECTION I.—THE TRYPANOSOMATA.

The **Trypanosomata** live as parasites in the blood of man and a large number of the lower animals. They are flagellated organisms with fusiform bodies, a centrally-situated nucleus, and a laterally placed undulating membrane. The free thickened border of this membrane terminates behind in the posterior half of the body in a centrosome (kineto-nucleus) or blepharoplast, while in front it is as a rule prolonged into a free flagellum. A large vacuole is often visible towards the posterior part of the body and in the same part of the parasite chromatin granules staining deeply with nuclear dyes are also found.

In the blood reproduction takes place by longitudinal binary fission (*schizogony*): the newly formed elements may undergo further division before they separate and by a repetition of this process a rosette arrangement is produced (*vide infra*).

The parasites are [in the majority of cases] transmitted by the bites of blood-sucking insects in which the Trypanosomes multiply by sexual reproduction (*sporogony*) and of which the details are still imperfectly known [but see *T. equiperdum* and *T. equinum*.]

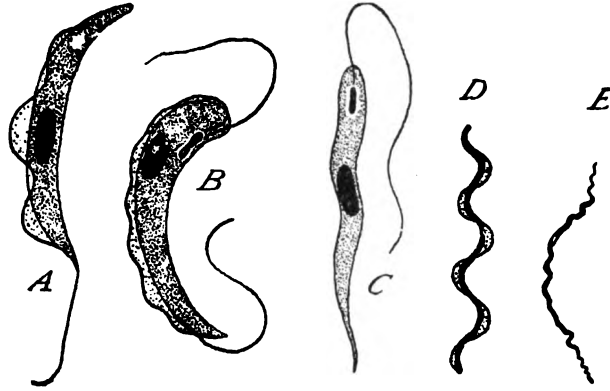

FIG. 387.—The *Trypanosomida*. (After Guiart.) A, *Trypanosoma*; B, *Trypanoplasma*; C, *Herpetomonas*; D, *Spirochaeta*; E, *Treponema*.

Schaudinn distinguished several genera of the *Trypanosomida*.

1. The genus *Trypanosoma*: having an undulating membrane and one flagellum.
2. The genus *Trypanoplasma*: having in addition to an undulating membrane and an anterior flagellum, a second free flagellum inserted into the posterior part of the body.
3. The genus *Herpetomonas*: having a free flagellum but no undulating membrane (p. 805).
4. The genus *Spirochaeta*: elongated, sinuous organisms having an undulating membrane, but no flagellum.
5. The genus *Treponema*: elongated, sinuous organisms having a short flagellum at each end but no undulatory membrane.

It has already been pointed out that this classification is not universally accepted and that by some observers the spirochaetes and treponemes are grouped with the bacteria (p. 711).

Methods of examination.—In searching for trypanosomes fresh blood should be examined in the same way as for the hæmatozoa (p. 771). For prolonged observation, such as the study of agglutination, hanging drop preparations (p. 132) luted with vaseline or paraffin are necessary. To prevent coagulation the blood should be mixed with citrated normal saline solution:—

| | | | | | | | | | | | |
|------------------|---|---|---|---|---|---|---|---|---|------|--------|
| Water, | - | - | - | - | - | - | - | - | - | 1000 | grams. |
| Sodium citrate, | - | - | - | - | - | - | - | - | - | 6 | " |
| Sodium chloride, | - | - | - | - | - | - | - | - | - | 6 | " |

The citrated blood may also be defibrinated. Or the blood may be allowed to coagulate; the trypanosomes then pass into the serum and can be studied unhampered by the red cells (Francis).

For stained preparations, the best method is that of Laveran, using Borrel's blue (p. 772). In the case of most of the *Trypanosomes* found in the malaria it is sufficient to stain for 5 or 10 minutes, but in the case of *Trypanosoma lewisi* the staining must be continued for 20 minutes (p. 806 fig. 388 appearances produced by staining).

Any of the methods described as useful for the *Hæmatozoa* are applicable to the staining of the *Trypanosomata*. One of the best stains is Laveran's

modification of Giemsa's stain (p. 774): it is specially useful for staining the trypanosomes of Nagana and Mal de Caderas.

Levaditi advises drying the blood films in the air and then fixing them in alcohol-ether. After fixing, the films are stained first in a saturated aqueous solution of Bismarck-brown and washed, and then stained for 2 minutes in Unna's polychrome blue diluted with an equal volume of water, washed, dried and mounted in balsam.

When the number of trypanosomes in the blood is small, thick films should be spread on slides and the hæmoglobin dissolved out either by Ross' or Le Dantec's method (p. 772). Laveran recommends fixing in absolute alcohol and dissolving the hæmoglobin in a 1 per cent. solution of acetic acid. Dutton and Todd aspirate a drop of blood and a drop of citrated normal saline solution into a capillary tube with a bulb; the fluids are mixed and the tube sealed in the flame and centrifuged; the red cells collect in the capillary part of the tube, and above them at the lower part of the bulb is a layer of leucocytes with which the parasites are mixed and this is used for examination.

For the study of the cytology of trypanosomes the following is the only method which, according to Salvin Moore and Breinl, gives satisfactory results.

Fixation.—Coat a slide with a thin layer of glycerin-albumin and spread a drop of blood over it, before drying dip the slide into a strong solution of Flemming's solution for 5–10 minutes, wash in alcohol of progressively increasing strength up to absolute alcohol then treat with iodine and iodide in 80 per cent. alcohol and finally in 30 per cent. alcohol.

Staining.—Stain with Heidenhain's iron-hæmatoxylin containing a few drops of a solution of lithium carbonate.

Cultivation.—Attempts have been made to cultivate Trypanosomes outside the body and reference will be made to the results later in the chapter. The medium used is blood-agar: either Novy and MacNeal's or Nicolle's may be employed (p. 799). Mathis recommends ordinary nutrient agar to which, after liquefying and cooling to 59° C., 1–2 parts of defibrinated blood (rabbit, rat, guinea-pig, ox or horse) are added: the mixture is heated to 75°–80° C. for half an hour, then solidified on the slope. Whatever the medium there must be a certain amount of water of condensation at the bottom of the tubes and into this the infected blood is sown. India-rubber caps should be slipped over the mouths of the tubes to prevent the medium drying up.

1. *Trypanosoma lewisi*.¹

The rat trypanosome.

This parasite was discovered by Gros and Chaussat in the field mouse, mole and black rat, and has been found by Lewis, Crookshank, Danilewsky, Laveran and Mesnil and others in *Mus decumanus*, *M. rattus*, *M. rufescens*, *Cricetus frumentarius*, etc. It occurs in a large percentage of rats all over the world.

The parasite is transmitted by the rat flea, [*Ceratophyllus fasciatus*, and by other fleas] and by the rat louse, *Hæmatopinus spinulosus* (Prowazek).

[The normal method of transmission is that the ripe, infective form of the Trypanosome—the final form of the developmental cycle which it passes through in the flea—is regurgitated from the stomach of the flea into the wound made by the proboscis of the flea during the act of feeding. Rats can be infected by devouring infected fleas but this is not the usual method by which the transmission of the Trypanosome from rat to rat is effected by

¹ The trypanosome of the rat is often described as *Herpetomonas lewisi* (Kent). This description is inaccurate because the fundamental characteristic of the genus *Herpetomonas* (type *H. muscæ domesticæ*) is the absence of an undulating membrane (*vide ante*).

the flea; on the contrary, it is an exceptional and aberrant method (Minchin and Thomson).]

Appearance in the blood.—In fresh blood, *T. lewisi* is flattened and fusiform and often twisted on itself. It is the most motile of all the Trypanosomes and vigorously displaces the red cells: it may sometimes be seen moving across the preparation like a dart with the flagellum in front. Its length including the flagellum is 24–25 μ , its breadth 1.5 μ (Laveran and Mesnil). Its protoplasm is finely granular; the [tropho-] nucleus is not visible but the centrosome [kineto-nucleus] appears as a refractile spot towards the posterior end.



FIG. 388.—*Trypanosoma lewisi* stained by Laveran's method. (After Laveran and Mesnil.) \times about 2000 diameters.

In preparations fixed and stained by Laveran's method (p. 772) the protoplasm is stained pale blue with fine granules; the [tropho-] nucleus, oval in shape and situated in the anterior one-third of the body, is stained lilac. The undulating membrane is unstained—with the exception of its free thickened border which is stained lilac—and is continued anteriorly into the flagellum, while posteriorly it takes origin from the centrosome which is stained deep violet.

In the blood of rats which have been infected for a long time only fully developed fusiform trypanosomes are seen, all of the same length.

To study the multiplication forms it is necessary to prepare stained films from the blood of a rat which has been inoculated intra-peritoneally 4–8 days previously.

The peritoneal exudate, which contains numerous multiplication forms during the first 2 or 3 days, is not a very suitable material for the study of the cytology of the parasites.

Before dividing, the Trypanosome increases in size, the centrosome approaches the nucleus and the flagellum thickens at the end which is in relation to the centrosome. Soon the nucleus and centrosome as well as the base of the flagellum divide. The newly formed flagellum separates from the original one and though at first much shorter than the latter, it rapidly elongates while the protoplasm is dividing. The young Trypanosome finally separates but may again subdivide before detaching itself.

Other multiplication forms have the appearance of spherical or oval bodies in which the nuclei and centrosome having approached each other divide (into from 2 to 16 parts), and the flagella at the same time split into two without the protoplasm dividing: then the protoplasm shows a series of notches around its periphery (rosette appearance) and finally divides into as many parts as there are nuclei. The small parasites resulting from the segmentation of the rosette may again in their turn divide.

Appearance in cultures.—Novy and MacNeal were able to grow the organism on their blood-agar medium (p. 799): growth takes place best at the temperature of the laboratory and is poorer at 34°–37° C. These observers have



FIG. 389.—*Trypanosoma lewisi*. \times 1000. Leishman's stain.

been able to sub-cultivate the organisms for 22 generations; the cultures are pathogenic and contain living, motile Trypanosomes. In old cultures rosette forms appear; these become more and more numerous and the culture dies after about 15–20 days in the warm incubator, but at a much later period if kept at the temperature of the laboratory.

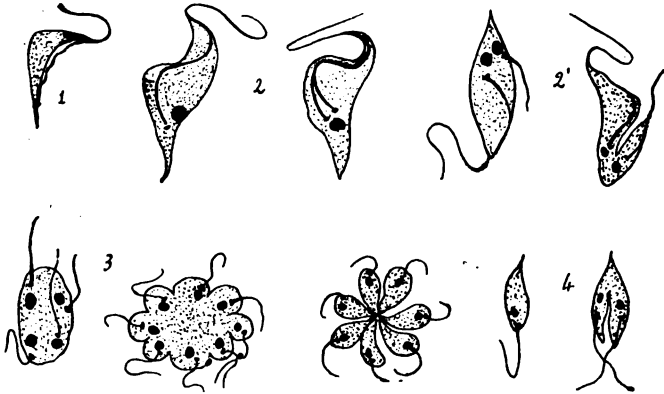

FIG. 390.—Multiplication forms of *Trypanosoma lewisi*. (After Laveran and Mesnil.) 1, adult trypanosome; 2, a trypanosome about to divide; 3, rosette forms; 4, young forms.

The size of the Trypanosomes varies considerably in the same culture. Some may be $50\text{--}60\mu$ long while others do not exceed $1\text{--}2\mu$ in length including the flagellum. This fact explains why it has been found possible to infect rats with the filtrates of cultures passed through a Berkefeld bougie.

The shape also of the Trypanosomes is very varied, and pyriform, rounded, and delicate fusiform parasites are seen. Numerous agglomerated masses occur in which the flagella are always directed towards the centre.

Agglomeration (Agglutination).—Laveran and Mesnil have shown that *Trypanosoma lewisi* will live much longer in blood kept in the ice chest ($5^{\circ}\text{--}7^{\circ}\text{C.}$) than at the temperature of the laboratory. In infected rat blood mixed with an equal volume of saline solution and defibrinated Trypanosomes will retain their vitality for 30–50 days if kept in the cold, whereas if kept at a temperature of $15^{\circ}\text{--}20^{\circ}\text{C.}$ they will die in about 3 days.

In blood kept in this way, Trypanosomes at first preserve their normal appearance and are very motile. But after about 3 days agglomeration commences: two Trypanosomes unite by their aflagellar extremities, others join them and form a sort of rosette, the flagellated ends of all remaining free and motile; the number of parasites entering the agglomerated mass increases daily. The blood is pathogenic so long as it contains motile parasites. Agglomeration occurs much more rapidly in hanging drops of the blood kept at laboratory temperature: under these conditions agglomerated masses may be observed after 24 hours.

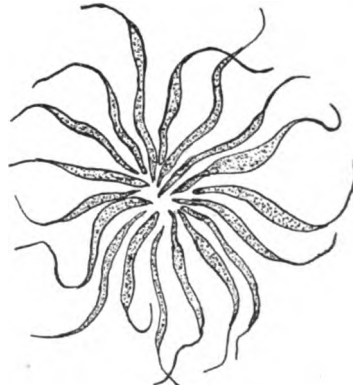

FIG. 391.—Agglomeration of *Trypanosoma lewisi*.

On adding some immunized rat serum or the normal serum of certain other animals (especially fowl, horse, dog, sheep, or rabbit) to defibrinated blood or serum containing Trypanosomes agglomeration takes place in a few minutes and is often complete. The rosettes may then collect together forming enormous masses visible to the naked eye. The parasites constituting these masses are motile. Disagglomeration is sometimes observed (Laveran and Mesnil): the trypanosomes which were instantaneously agglomerated by the serum again become free in a few hours. While the property of agglomeration appears rapidly in the blood of immunized animals, the paralyzing property (leading to the immobilization of Trypanosomes whether agglomerated or not) is only seen in hyperimmunized animals.

Experimental inoculation.—Rats are readily infected with *Trypanosoma lewisi*, but with the exception of the guinea-pig—in which a very short and abortive infection occurs—no other animals are susceptible. Infected blood or a culture will reproduce the disease when inoculated into the peritoneal cavity, into the blood stream, sub-cutaneously or even into the stomach of the rat. Rats become infected by consuming the blood of infected rats (Francis: not confirmed by Laveran).

The most certain method of infection is by intra-peritoneal inoculation. During the first 3 days following the inoculation the parasites multiply in the peritoneal cavity and numerous reproduction forms can be seen. Then the trypanosomes disappear from the peritoneal cavity, but appear in the blood where they rapidly multiply: multiplication forms are however less numerous in the blood than they are in the peritoneal cavity. At the end of a week the trypanosomes cease to multiply in the blood, and for a period varying from 20 days to 4 months only slender adult parasites are seen (latent period).

The number of parasites in the blood varies. Sometimes there are as many as 1 to every 2 or 3 red cells.

Generally speaking, the presence of Trypanosomes in the blood of the rat is unaccompanied by any symptoms of disease; in some cases, however, the infection may prove fatal (Jürgens, Francis, and others).

Immunity.—Rats in which parasites appeared in the blood after a first inoculation of trypanosomes never show a blood infection on subsequent inoculation. The serum of rats which have been inoculated several times with trypanosome blood is prophylactic, and if inoculated at the same time as the parasites into the peritoneal cavity of a normal rat the trypanosomes do not pass into the blood (Kempner and Rabinowitch): it fails however to cause the elimination of trypanosomes from the blood of infected rats during the latent period (Laveran and Mesnil).

The serum of immunized rats has powerful agglutinating properties and rapidly leads to rosette formation when diluted from five to fifty times.

Trypanosomes in rodents other than rats.

Jolyet and de Nabias have found trypanosomes in the blood of four out of ten rabbits examined in Bordeaux. The trypanosome-infected rabbits were generally thin and wasted, and suffered from diarrhoea. The trypanosomes were long, and including the flagellum measured 30–36 μ ; the body was nucleated, cylindrical in the centre, pointed behind and terminated anteriorly in a flagellum: the undulating membrane was very narrow and could only be seen after staining. In fresh blood the parasites were highly motile.

Trypanosomes have also been found in rabbits by other observers (M. Nicolle, Petrie), as well as in guinea-pigs (Künstler), mice (Dutton and Todd), squirrels (Donovan, Laveran), ground-squirrels (Chalacknikow), etc.

2. *Trypanosoma equiperdum* (Doflein).**Trypanosome of Dourine.¹****Syn.**—*Trypanosoma rougeti*.

The trypanosome of dourine was discovered in Constantinople by Rouget, in the blood of a stallion affected with *mal du coit*. It has been studied more recently by Schneider and Buffard.

Horse syphilis is transmitted by the act of coitus, perhaps also by fleas (Rabinowitch and Kempner, Sieber and Gonder). In the first stage of the disease in the stallion there is œdema of the penis, scrotum and inguinal regions; in the mare this painless œdema affects the vulva and vagina and leads to a more or less abundant mucous secretion. In the second stage—about a month after coitus—characteristic infiltrated firm plaques appear, affecting the sub-cutaneous tissue covering the ribs, the crupper and sometimes the neck, shoulders and thighs. Finally, in the third stage, extreme anæmia, paralysis and sometimes epileptiform attacks appear. Recovery is exceptional and when it does occur is as a rule merely apparent, the animal soon suffering a relapse.

Morphology.—The trypanosome of dourine is fusiform in shape and measures about 25–28 μ long by 2 μ broad in the centre. Its protoplasm stains uniformly blue by Laveran's method and contains no chromatin granules. The nucleus is distinctly centrally situated. There is a folded undulating membrane the free border of which terminates anteriorly in the flagellum and is lost posteriorly in the centrosome. It is distinctly less motile than *T. lewisi* but nevertheless shows obvious movements of translation: the motility is still apparent after about 18 hours in preparations of fresh blood.

Reproduction appears to take place in the same way as in *T. lewisi*; binary longitudinal fission is the method most frequently seen. Forms with 8 to 10 nuclei developing into a sort of rosette have been recorded (Laveran, Rabinowitch, Kempner).

Cultures.—All attempts to grow *Trypanosoma equiperdum* outside the body in the blood of susceptible animals have failed (Rouget): in such blood the parasite loses its virulence in less than 24 hours.

Experimental inoculation.—Cold-blooded animals, birds, cattle, monkeys and guinea-pigs are immune.

Mice, white rats, rabbits, dogs, horses and mules are all susceptible to infection.

In determining the susceptibility of a given animal to the parasite it is necessary to take into account the adaptation which the parasite undergoes as a result of repeated passages through a given species (Nocard). Rouget experimenting with rats and mice recovered a parasite which proved to be very virulent for these animals. Schneider and Buffard after several passages through dogs recovered a trypanosome which was harmless for mice and rats; this trypanosome was inoculated by Nocard into the brain of a young rat, which it infected, and it was then found to be virulent for adult rats.

¹[Dourine, Horse syphilis, or Mal du coit is a disease of horses occurring in Europe, North America, Algeria and India.]



FIG. 392.—*Trypanosoma equiperdum*.
Leishman's stain. $\times 1000$.

Infection of susceptible animals is very easily effected by inoculating a trace of blood-stained serous exudate or a few cubic centimetres of infected blood sub-cutaneously, intra-peritoneally or intra-venously: it is sufficient even to place a drop of the blood-stained exudate on a superficial excoriation of the skin or on an uninjured mucous membrane to infect the animal. Attempts at infection by ingestion have always failed. In one instance the seminal fluid of a rabbit contained the parasite and the animal infected an healthy doe by the genital passage (Rouget).

Mice. White rats.—In these animals the parasite rapidly becomes generalized: mice die in 5–6 days, the blood and internal organs swarming with trypanosomes. Infection cannot however be obtained in every case and the results vary with trypanosomes from different sources: many strains fail altogether to produce an infection.

Rabbits.—In infected rabbits the trypanosomes are found only intermittently in the blood. The animals suffer from an irregular fever, but there is no relation between the paroxysms of fever and the occurrence of trypanosomes in the blood. The rabbits exhibit certain characteristic symptoms; for instance, œdema and sloughing of the ear, muco-purulent conjunctivitis, swelling and sloughing of the external genitalia, paraplegia and cachœxia. Death takes place after 2–4 months.

Horses.—About the fourth day following the sub-cutaneous inoculation of the parasite, there is an œdematous infiltration of the cellular tissue about the site of inoculation; the exudate contains numerous leucocytes and some feebly motile trypanosomes which however are larger than the parasites found in films of the blood. About the sixth day the nuclei of the trypanosomes are seen to be divided into two or three masses: then the œdema increases rapidly and forms a tumour containing a blood-stained exudate in which the parasites are present in considerable number.

According to Schneider and Buffard, the trypanosomes found in the exudate are of various shapes.

1. Adult trypanosomes similar to those just described.
2. Large, pyriform, non-motile bodies with appendices not unlike the posterior segments of the trypanosomes: this V-shaped form—which, seen from above, is like a comb or a squid—represents longitudinal division of the parasite and is similar to the figures seen in *Trypanosoma lewisi*.
3. Trypanosomes arranged in pairs or groups of four radiating from a central point like a star and formed by the meeting of their posterior ends: this represents a later stage of longitudinal fission.

The parasites in the exudate begin to diminish in number from the eighth to the tenth day and, together with the œdematous tumour, soon disappear. The developmental cycle of the trypanosome lasts about a week.

After this the parasites are present only in small numbers in the peripheral blood, but occur in large numbers in the plaques which now soon make their appearance.

Schneider and Buffard think that the plaques seen in dourine are due to a secondary multiplication of the trypanosomes in the capillaries of the skin—where they are arrested—and that the young forms resulting from this division reinfect the blood stream: “the hæmorrhagic foci and areas of softening found in the central nervous system are also produced by the migration of the trypanosome into the medullary vessels which it blocks and perforates.”

Asses.—Asses are less susceptible to the parasite of dourine than horses: the succession of forms is less regular, and the swelling assumes considerable proportions from the first; when the œdema subsides, the parasite passes into the general circulation. The trypanosomes which are present at first in large numbers in the blood soon become fewer and fewer: then, 6–8 days

after the first swelling has disappeared, a second swelling occurs at the site of inoculation, in which the parasites multiply and soon cause a fresh infection of the blood. The disease runs a distinctly intermittent course and the parasite only multiplies at the site of inoculation.

Dogs.—Dogs in Europe are highly susceptible. The initial swelling lasts a long time and the trypanosome only infects the blood stream after an interval of 15 or 16 days. It is probable that subsequently multiplication takes place in all the organs of the body. The most pronounced symptoms are conjunctivitis, keratitis, and hypopyon, cedema of the external genitalia, and paralyses.

Indian dogs are highly immune to the dourine of India (Pease, Lingard).

Immunity.—Rouget has shown that the blood of infected rabbits and dogs collected in the last stages of the disease has immunizing properties. Such blood, injected as a prophylactic either alone or mixed with the virus, protects mice against infection. It has no therapeutic properties.

3. *Trypanosoma brucei*. The trypanosome of Nagana.

Sir David Bruce has shown that Nagana or "Tsetse-fly disease" (*Glossina morsitans*) is due to a trypanosome.

Nagana is a disease affecting horses, asses, mules, oxen, dogs etc. in South East and Central Africa.

The disease is transmitted by the Tse-tse fly (*Glossina morsitans*). [It can also be conveyed from infected to non-infected animals under experimental conditions by *Glossina palpalis*]. It is probable that the fly often infects itself by biting wild animals (buffaloes, etc.) whose blood not infrequently contains trypanosomes although the animals themselves show no signs of disease (Bruce).

Carnivora (dogs, etc.) appear to contract the disease by feeding upon the flesh of animals dead of Nagana. It seems also to be proved that animals infected with the disease may transmit the infection by biting healthy animals: such transmission may possibly in the cases observed have been due to the presence in the saliva of infected blood from erosions of the gums.

Morphology.—*Trypanosoma brucei* is found in varying numbers in the blood of infected animals.

In the fresh condition the parasite occurs as a motile vermicule having an undulating membrane and an anterior flagellum: the posterior end is sometimes filiform, sometimes rounded or like a section of a fir cone. The movements though very active are prolonged, and darting movements like those seen in *T. lewisi* are never observed. All the parasites are much of the same size; some are broader than others and have two undulating membranes (a stage of multiplication).

In fixed and stained preparations, the parasites measure, including the flagellum, 26–27 μ in length and 1.5–2.5 μ in breadth. In horses' and asses' blood the length generally reaches 28–33 μ . The protoplasm is stained rather deeply by Laveran's method and has a number of large, deeply-staining granules in its anterior part. The nucleus is centrally situated, oval in shape, and stains rather less deeply than the

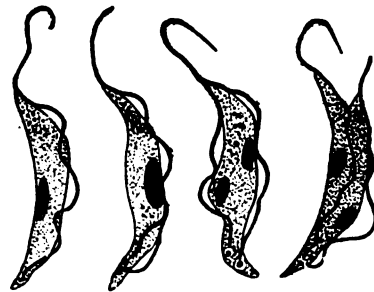

FIG. 398.—Trypanosome of Nagana (*Tr. brucei*). (After Laveran and Mesnil.) On the left, an adult trypanosome; on the right, a trypanosome undergoing division (three successive stages).

centrosome in which the flagellum terminates [cf. morphology of *T. gambiense*, p. 818].

Multiplication takes place by binary longitudinal fission (Laveran and Mesnil); this commences with division of the centrosome, and is soon followed by division of the flagellum, nucleus and protoplasm (fig. 393).

Involution forms.—Under unfavourable conditions involution forms make their appearance: the trypanosomes become stumpy, roll up into balls and form small agglomerations. These forms were taken by Bradford and Plimmer to represent stages of multiplication.

When a trypanosome dies the cytoplasm disappears first, then the nucleus, and finally only the flagellum and centrosome remain.

Cultures.—Novy and MacNeal obtained cultures of *Tr. brucei* on their blood-agar medium. Cultures often remain sterile so that it is advisable to sow a large number of tubes to ensure a successful result. Growth takes place between 25° and 34° C., but the higher the temperature the more quickly do the parasites die: at the temperature of the laboratory a culture may remain alive for 45 days. Novy and MacNeal have succeeded in sub-cultivating to the fourteenth generation.

Cultures grown at 25° C. are seldom as virulent as trypanosomes from the blood and only kill rats and mice in 7–10 days instead of in 3–5: at 34° C. they rapidly lose their virulence.

In cultures the trypanosomes are generally arranged either in pairs connected by their aflagellar ends, or in rosette-shaped colonies consisting of 10 to 20 individuals, the flagella appearing to be situated at the periphery of the rosette.

Agglomeration.—Outside the body the trypanosomes in the blood of infected animals soon exhibit—apart from the involution forms which have been described—the phenomena of agglomeration (Laveran and Mesnil, Martini). Forms similar to those which have already been described as occurring in cultures—association of two parasites and rosette-formation—are seen. The agglomerated masses may break up after a variable time.

Agglomeration is hastened by the addition of serum from a dog, horse, sheep, pig, monkey, etc. Human serum exhibits no agglomerating action, and the serum of an immunized goat has no more agglomerating action than a normal goat's serum. The serum of a cow, immunized by Nocard, was highly agglomerating but had no trypanocidal properties.

Experimental inoculation.—*Trypanosoma brucei* will readily infect most of the mammalia. Man however is [thought to be] immune.

Inoculation is followed by infection whether the blood of the infected animal (which is the material generally used) be inoculated sub-cutaneously, intravenously, or intra-peritoneally.

Infected blood, if kept free from contamination, loses its virulence outside the body in a few days whether it be kept in the ice chest or at laboratory temperature (Laveran). Desiccation also renders it harmless.

The incubation period varies for a given species both with the number of parasites inoculated and with the condition of the parasites. The disease is always acute and fatal in mice, rats, dogs and monkeys; subacute in rabbits, guinea-pigs, horses, asses and pigs; and chronic in cattle, sheep and goats: these last may recover from infection. Grothusen and Martini have succeeded in infecting a zebra: this fact is in contradiction to the immunity which the zebra seems to possess in nature.

The most constant symptoms in all animals are œdema, fever, anæmia, wasting and paralyses. In rats and mice the parasites multiply until at

the time of the death of the animal they number as many as the red cells: in other animals they are not so numerous.

Immunity.—Laveran has shown that human serum has a specific action on infected animals. When human serum (1–2 c.c. for a rat weighing 200 grams) is inoculated sub-cutaneously into an infected rat or mouse, the parasites rapidly disappear from the blood: but they reappear after 4–8 days. By repeating the injections the life of the infected animals can be considerably prolonged, though a permanent cure is never obtained.

Human serum is feebly prophylactic. Thus, when inoculated at the same time as the trypanosomes it will sometimes prevent infection but the animal is not immunized: if inoculated 24 hours before the virus infection is delayed. The serum of all the lower animals (monkeys, etc.) is without any action.

Some species of animals (cattle, goats and sheep for example) often recover from an attack of Nagana, and they are then immune to the disease and their blood has prophylactic properties against *Tr. brucei* (Laveran).

Schilling and Koch have devised a means of vaccinating cattle. The method consists in using a trypanosome which has been passed two or three times through dogs or through dogs and rats alternately: the passage virus sets up usually a mild infection in cattle and the animals become immune, but occasionally a severe infection is produced. To avoid this Schilling increased the number of passages, first passing the trypanosome seven times through dogs and rats alternately, then eighteen to twenty times through dogs only. It is stated that bovine animals resist inoculation with this passage virus very well and that their serum exhibits bactericidal properties for the trypanosome: but the efficiency of the method has yet to be confirmed. It is inapplicable in the case of horses since these animals succumb to the inoculation of the passage virus.

Martini succeeded in keeping alive for a long time two asses which had resisted inoculation with a trypanosome after it had been passed through mice and which had been subsequently inoculated five times intra-venously. The serum of these asses, which ultimately died, proved to be prophylactic for mice. At the time of death their blood was infective for the dog.

Laveran and Mesnil have tried, but unsuccessfully, to produce immunity by inoculating animals with an attenuated virus (attenuation being effected by age, heat, cold, mixing with toluidine blue, etc.). The incubation period following the inoculation of the attenuated trypanosomes is longer than normal, but once the disease develops it runs its ordinary course.

African Trypanosomiases related to Nagana.

Animals in Africa are subject to many trypanosome infections. The parasites in these diseases are all more or less like *T. brucei* and may be divided into several species.

Trypanosoma soudanense.—Szewczyk, and Rennes have observed an epizootic among horses in the French Sudan (**Mal de la Zousfana**) running a chronic course and having as its causal agent a trypanosome (*Trypanosoma soudanense*) similar to that of Surra (Laveran).

The same parasite is responsible for the disease of dromedaries observed by Cazalbou in the French Sudan and known as **Mbori** or "the fly disease," and of the disease of dromedaries described by Ed. and Et. Sergent in Algeria and known as **El Debab**.¹

Trypanosoma dimorphon, studied by Dutton and Todd in Gambia, which infects mules, cattle, sheep and horses in French Guinea, Dahomey, the Congo and Senegal. It is also closely related to the trypanosome of Nagana.

Trypanosoma congolense (Brodden) has been found in the Congo in sheep and asses in the neighbourhood of Leopoldville, and in cattle, dogs and sheep near Brazzaville. It is very closely related to *T. dimorphon*.

¹ [*El Debab*, the fly or horse fly.]

Trypanosoma cazalbovi (Laveran) is the cause of a disease of horses and cattle in the Soudan known as **Souma**.

Trypanosoma pecaudi (Laveran) is the infecting agent in **Baléri**, a disease of horses and other beasts in the Soudan.

4. *Trypanosoma evansi*.

The trypanosome of Surra.

Evans described a disease, Surra,¹ affecting horses, elephants and camels in India, which is due to a trypanosome other than that which causes Nagana.

[But since it has been shown that *Mbori*, a disease of dromedaries in the Sudan, is caused by a species of trypanosome similar to that of Surra this latter disease can now no longer be regarded as limited to India, and Laveran is of the opinion that other African epizootic diseases due to trypanosomes other than *T. brucei* may also be varieties of Surra.]

T. evansi on inoculation will produce an infection in rats, mice, dogs, monkeys, cattle, horses, asses and mules.

Infected horses and mules invariably die of an acute disease, but bovine animals and sheep and goats often recover after suffering from a sub-acute or chronic infection. Animals which recover are immune to the disease. In *Bos indicus* (the Indian sacred bull) the immunity does not appear to last more than 2 years (Wryburg).

Morphologically, *T. evansi* and *T. brucei* are identical, though perhaps the former is more slender and more motile than the latter (p. 811) and contains fewer chromatin granules.

The two parasites are however specifically different, and the diseases to which they give rise cannot be regarded as identical (Laveran and Mesnil). Goats hyper-immunized against Nagana are as susceptible to Surra as non-immunized goats (Laveran and Mesnil), and a Brittany cow which had recovered from Nagana and was hyper-immunized against that disease proved as susceptible to Surra as did a normal animal of the same race (Nocard).

It is difficult to obtain cultures. Laveran and Mesnil only succeeded once in six experiments: the organism died out after the first sub-culture.

The disease appears to be transmitted by a fly of the genus *Tabanus* and perhaps also by a *Stomoxys*. [Possibly by more than one species of each of these genera. In any case Surra is, like Nagana, mainly propagated by biting flies (Laveran and Mesnil).]

5. *Trypanosoma equinum*.

The trypanosome of Mal de Caderas.

Mal de Caderas² is a fatal disease of Equidæ in South America: it is characterized by fever, progressive wasting, profound anæmia and paralysis of the hind quarters. The disease is contagious, but the channels of infection are absolutely unknown, so that it is not even agreed whether biting insects play any part in the spread of the disease or not.

[Sexual intercourse does not give rise to infection as it does in the case of dourine (Lignières). The only fact upon which all observers are agreed is that the *Capybara* (*Hydrochaerus capybara*) is the source from which the carrier of the disease probably obtains its supply of the virus. When the farmers in Paraguay find dead *Capybaras* on their farms, they know that caderas will soon break out among the horses. There is a striking analogy between this mortality among the *Capybaras* which

¹[Surra is the word which has been used from time immemorial by the natives of certain parts of India to denote a disease of horses, characterized by profound cachexia without any lesion being found *post mortem* to account for it (Laveran and Mesnil).]

²[Mal de caderas denotes disease of the hind-quarters and is so called from the paralysis of that part of the body which is so characteristic a symptom of the disease.]

precedes epizootics of Mal de caderas and that among rats which precedes epidemics of plague. Lignières has infected rats with Mal de caderas by inoculating them with fleas crushed in salt solution (Nabarro's translation of Laveran and Mesnil's "Trypanosomes").]

Morphology of the parasite.—*Trypanosoma equinum* was discovered by Elmassian [in Paraguay in 1901]. In fresh preparations it is morphologically indistinguishable from *T. brucei* and *T. evansi*; in stained preparations however the characters of the centrosome differentiate it clearly from allied parasites.

The centrosome is very small, and since it stains like the flagellum it is difficult to distinguish. [In trypanosomes of the type *T. evansi*, on the other hand, the centrosome is very obvious and measures about 0.5μ and stains deep purple (Laveran and Mesnil).]

T. equinum measures $22-24\mu$ long by about 1.5μ broad. It multiplies like *T. brucei* by binary longitudinal fission.

Agglomeration in the blood, which is favoured by the addition of normal sheep, pig or horse serum and particularly of serum from bovines, sheep or pigs infected with caderas, gives rise to rosette forms in which the posterior ends are in apposition.

The number of trypanosomes in the blood of infected Equidæ varies at different periods of the disease. In the early stages the parasites are very scanty but as death approaches they become more numerous; they are not however constantly present in the blood in the course of the naturally contracted disease, and there are times when no parasites can be found. Trypanosomes are found when the temperature of the animal rises above 38°C . but disappear when it reaches 41°C . (Elmassian and Migone).

Vitality.—In blood kept at the ordinary temperature *Trypanosoma equinum* dies rapidly but if the blood be kept in the ice chest the parasite will live for 3 days. The addition of normal serum (fowl, horse, sheep, rat or bovine) to the blood lengthens the life of the parasite by from 5-11 days.

Cultures.—Laveran and Mesnil failed to grow *T. equinum* on blood-agar at room temperature. Thomas and Breinl using a modification of Novy and M'Neal's medium—chicken-broth-rabbit-blood agar—grew a *T. equinum* from rabbits' blood at 22°C . and infected a rat after 29 days' incubation: sub-cultures failed.]

Experimental inoculation.—Horses, mules, asses, monkeys, mice, white rats, guinea-pigs, rabbits and dogs are all susceptible to experimental infection. No symptoms are produced in sheep, cattle and pigs, but the blood of these animals remains infective for mice for about 2 months after inoculation. Birds are immune.

Human serum has a specific action on animals infected with Caderas (Laveran and Mesnil). Laveran was able to cure 10 per cent. of mice experimentally infected by inoculating them with human serum.

Sheep, goats, bovines and pigs which have recovered from an infection with *T. equinum* are immune and their serum has for a short time some slight prophylactic property.

Specific nature of Mal de Caderas.—Caderas can be differentiated from other Trypanosome infections by a study of the immunity reactions. Dogs which have recovered from an infection with the parasite of dourine and which are therefore immune to that disease are as susceptible to Caderas as normal dogs (Lignières). A goat and a sheep cured of and immune to Nagana were just as susceptible to Caderas as normal control animals. The serum of animals cured of Nagana has no action on *T. equinum* (Laveran and Mesnil).

6. *Trypanosoma theileri*. Trypanosome of "Galziekte."

Cattle in the Transvaal [and in the Orange River Colony, Cape Colony and possibly in other parts of South Africa] are subject to a disease, known to the farmers of South Africa as Galziekte [gall-sickness], which is characterized by anæmia and may or may not be accompanied by fever. It may assume a malignant form and rapidly terminate in the death of the animal. Theiler found a trypanosome in the blood of the affected animals and this was described [almost simultaneously] by Laveran [and Bruce]. The trypanosome of Galziekte (*T. theileri*) is the largest of the mammalian trypanosomes, being almost twice the size of *T. brucei*: it measures 60–70 μ long by 3–4 μ broad in the larger forms, while the smallest forms measure from 25–30 μ long by 2–3 μ broad. The protoplasm stains deeply and is very granular: the nucleus is oval and centrally situated: the centrosome is rounded, stains well and is placed some little distance from the posterior end of the parasite. Multiplication takes place by binary longitudinal fission.

Cattle are the only animals susceptible to inoculation with *T. theileri*. Cattle which survive an attack of the disease are immune.

The disease is transmitted by the bites of flies of the family *Hippoboscidae* (*H. rufipes* and *H. maculata*). [*H. maculata* is very rare in South Africa where it appears to have been introduced at the time of the Boer War with cavalry horses coming from India (Laveran).] Theiler has succeeded in infecting healthy animals by placing on them *Hippoboscæ* taken from affected animals.

7. The trypanosomes of sleeping sickness.

[Human Trypanosomiasis. Negro Lethargy. Trypanosome fever.]

A. *Trypanosoma gambiense*.

In 1898 Nepveu found trypanosomes in the blood of a man in Algeria, but his descriptions were so lacking in precision as to make his conclusions doubtful.

In 1902 Dutton [in conjunction with Forde] discovered trypanosomes in the blood of an European who had lived in Gambia for 6 years and who was suffering from a disease which ultimately proved fatal. The disease was characterized chiefly by an irregular fever which did not yield to quinine, œdema of the face and lower limbs, cutaneous erythema, hypertrophy of the spleen, enlargement of the lymphatic glands and general weakness. Dutton described the parasite as *Trypanosoma gambiense*.

Manson and Daniels, and Manson and Broden soon afterwards confirmed Dutton's discovery by finding trypanosomes in man on the Congo, and cases of human trypanosome fever were soon afterwards recorded by Baker in Uganda, Brumpt in the Congo, and Forde in Uganda; and Dutton and Todd several times found trypanosomes in natives of Gambia suffering from mild indefinite maladies.

In 1903 Castellani found trypanosomes in the cerebro-spinal fluid of 70 per cent. of persons affected with sleeping sickness. The observations were soon confirmed by Bruce and Nabarro and by Brumpt. Castellani's trypanosome (*Trypanosoma ugandense*) is practically always found in the cerebro-spinal fluid [as well as in the blood and gland juice (Nabarro)] of persons suffering from sleeping sickness, and has never been found in the cerebro-spinal fluid of persons free from the disease.

Sleeping sickness is the cause of a very considerable mortality among the negroes of the West Coast and centre of Africa: for some years past it has decimated the negro population of Uganda and the Great Lakes. The disease has a great pre-

dilection for the negro race but also attacks mulattos and several cases have been recorded in Europeans.

Further observation tended to show that the Trypanosomes of Dutton and of Castellani must be regarded as one and the same organism, *Trypanosoma gambiense* (Bruce, Nabarro and Greig, Laveran). Morphologically they are indistinguishable: and the difference between sleeping sickness and trypanosome fever is merely a function of the localization of the same trypanosome in the body. Sleeping sickness has been produced in the monkey by the inoculation of Dutton's trypanosome. If the trypanosome is in the blood, the disease produced is Dutton's disease, trypanosome fever; if in the cerebro-spinal fluid then the symptoms are those of sleeping sickness. [It must be noted however that Nabarro states that if the trypanosome be carefully looked for in sleeping sickness patients it can be found not only in the cerebro-spinal fluid but also in the blood and gland juices.] Manson has recorded a case in which sleeping sickness developed in an European who up till that time had only shown symptoms attributed to Dutton's trypanosome. Monkeys which have acquired an immunity against *T. gambiense* are also immune against *T. ugandense* [and *vice versa*; but subsequent investigation has shown that this acquired immunity is apparent rather than real and the most recent work tends to show that no immunity is attainable with the trypanosome of sleeping sickness (Laveran, Nabarro and others). However it is now almost, if not quite, universally believed that *T. gambiense* and *T. ugandense* are the same species (Nabarro)].

[More recent investigations have however thrown some doubt upon the identity of all trypanosomes found in man.

[Stephens and Fantham for instance have isolated a trypanosome from an European who became infected in some part of North-East Rhodesia. This trypanosome they regard as a new species (*Trypanosoma rhodesiense*) and in this opinion they are supported by Laveran from his own experiments and observations (see p. 820).

[Castellani also is disposed to revert to the opinion he held in 1903 that there may be more than one species of human trypanosome, possibly transmitted by the same fly, in the same way that different species of malarial parasites are transmitted by the same mosquito.]

Methods of detection.—As a general rule the blood and cerebro-spinal fluid should be examined for trypanosomes and as the latter are often present only in very small numbers the fluid should be centrifuged.

Cerebro-spinal fluid.—10–15 c.c. of fluid should be withdrawn by lumbar puncture (p. 199). The first few drops are rejected as they may contain a little blood and this would interfere with the examination. The fluid should then be centrifuged at once for a quarter of an hour and the whitish deposit used for making films, which must be stained by one of the usual methods (p. 804). [It is better to examine fresh unstained films as the trypanosomes obtained by centrifuging cerebro-spinal fluid do not stain well.]

Blood.—When direct examination of blood films has failed to reveal the presence of trypanosomes, Bruce and Nabarro collect 10 c.c. of blood in a tube containing a little [1 per cent.] potassium citrate solution, centrifuge for 10 minutes, pipette off the supernatant plasma [together with some of the middle layer and a little of the red corpuscle layer] and centrifuge this again. They repeat the operation four times and use the deposit from the fourth centrifugation for making films for microscopical examination.

The method of Le Dantec (p. 772) may also be employed.

To complete the identification of the organism it will also be well to inoculate a little of the suspected blood or cerebro-spinal fluid into a susceptible animal (for example, into the peritoneum of a rat).

For stained preparations the deposit obtained on centrifuging the cerebrospinal fluid is not very satisfactory and the preparations made from it are always poor. Trypanosomes stain better in blood films but as they occur only in small numbers in human blood it is better to inoculate an animal and stain films of the animal's blood.

Greig and Gray, Dutton and Todd, and Beck recommend puncturing an hypertrophied lymphatic gland with an ordinary hypodermic syringe and examining the drop of gland juice thus obtained. ["Gland puncture is by far the most efficient method of demonstrating the presence of trypanosomes in cases of trypanosomiasis" (Dutton and Todd).]

Nattan-Larrier and Tanon have always been able to find the parasite in films made with blood obtained by scarification of the erythematous patches on the skin.

Morphology.—The human trypanosome has all the ordinary generic characters of other trypanosomes. It is highly motile [but exhibits but little or no translatory power in the field of the microscope (Bruce)]. The cytoplasm contains chromatin granules: the nucleus is oval and situated in the centre of the parasite: the undulating membrane is narrow: and the flagellum, representing as a rule about one-quarter of the total length of the trypanosome, occasionally has no free portion at all, the cytoplasm extending to the distal extremity of the flagellum. The centrosome stains well. Sometimes a vacuole is seen round or near the centrosome: [Laveran and Mesnil regard this as a result of deficient technique, but Nabarro thinks that vacuoles are normally present at times].

[The trypanosome is 15–33 μ long and in breadth averages 1.5 μ in the long to 2.5 μ in the short and stumpy forms (Bruce). Great differences are sometimes found in the average length in the same individual. For instance in one case, an European, at the beginning of the illness the trypanosomes averaged 17 μ in length whereas at a later date they averaged 25.8 μ .] Multiplication takes place by longitudinal fission (p. 803).



FIG. 394.—Different appearances presented by *Trypanosoma gambiense*. n, Nucleus; c, Centrosome; m, m, Undulating membrane; fl, flagellum.

[*T. gambiense*, "like *T. brucei*, is markedly dimorphic. In size and general appearance also these two species so closely resemble one another that one might easily believe them to be varieties of the same species. There are, however, some slight differences in morphology, . . . but whether these differences will bear the test of more extended observations remains to be seen" (Bruce).]

In the blood, trypanosomes are occasionally seen in pairs with their posterior [aflagellar] ends crossed (Laveran and Mesnil).

When the trypanosomes become very numerous in the blood they pass to the spleen and bone marrow, and subsequently disappear from the blood of the peripheral circulation. The parasite assumes a new character in the spleen: a deep band makes its appearance between the centrosome and the nucleus and the latter becomes surrounded by a vacuole, the trypanosome disintegrates and is reduced to a nucleus; this represents the latent form of the parasite. The nucleus soon divides, giving rise to a new centrosome from which a flagellum takes origin, thus a small trypanosome of the ordinary appearance is produced (fig. 395); the latent forms disappear, and the newly formed parasites pass again into the blood of the peripheral circulation.

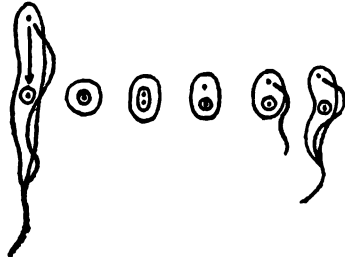

FIG. 395.—*Trypanosoma gambiense*. Formation of the latent stage and transformation of the latent stage into a trypanosome. (After Guibert.)

Vitality.—The trypanosomes of sleeping sickness can be kept alive for 4 or 5 days in blood mixed with normal saline solution and kept at room temperature. In rabbit-blood-agar the organisms live longer but no true cultures have been obtained (Laveran and Mesnil).

Experimental inoculation.—Monkeys, rats, guinea-pigs, rabbits, dogs, asses, horses, goats, sheep, etc. are all susceptible to inoculation with *Trypanosoma gambiense*.

Only certain species of monkeys are, however, susceptible (*Macacus rhesus*, *M. cynomolgus*, *Cercopithecus callitrichus*, *C. ruber*, *C. sphinx*, etc.). The *Cynocephali* seem to be immune: exceptions have however been recorded by Thomas and Breinl.

The disease which follows sub-cutaneous or intra-venous inoculation of the parasite into susceptible animals is very similar to human trypanosomiasis. Sleeping sickness has followed intra-spinal inoculation, the incubation period varying from 10–45 days.

Brumpt inoculated a *Macacus cynomolgus* with *T. gambiense* with the result that the monkey died in 5 weeks with all the symptoms of sleeping sickness. Numerous trypanosomes were found in the blood: they were strongly agglomerated by mixing the blood with an equal volume of potassium citrate solution or with serum from an horse, bovine animal, dog or man.

Bruce was able to infect monkeys (*Macacus rhesus* and *Cercopithecus*) by inoculating them either sub-cutaneously, intra-venously or intra-spinally. Following the inoculation parasites were found in the blood, then symptoms of disease appeared and death took place in from 2–5 months. In a few of the monkeys inoculation was followed by the appearance of parasites in the blood but the animals recovered without showing any symptoms.



FIG. 396.—*Trypanosoma gambiense*. Stained by Laveran's method. (After Laveran and Mesnil.) Magnification about 2000 diameters.

White rats can be easily infected and most readily by intra-peritoneal inoculation. Trypanosomes appear in the blood about a fortnight after inoculation. The disease lasts about 3 months: trypanosomes are found in large numbers in the later stages. The animals often recover and some of them, but by no means all, are immune.

Dogs and cats are easily infected and the disease proves fatal, as a rule, in 5–6 weeks.

In most mammals (guinea-pigs, mice, goats, rabbits, cattle, horses, etc.) the trypanosome multiplies in the blood, but the course of the disease is very slow and frequently ends in recovery. The presence of trypanosomes in the blood is often unaccompanied by symptoms (Dutton and Todd).

Ætiology.—Bruce and Nabarro showed that human trypanosomiasis and one of the tse-tse flies (*Glossina palpalis*) have a very similar distribution: and they proved by actual experiment that this fly is the agent by which the disease is spread. In five experiments flies fed on patients suffering from sleeping sickness for 8–48 hours infected monkeys (*Cercopithecus*). Similarly, Bruce infected three monkeys by allowing them to be bitten daily over a long period by a large number of *Glossina palpalis* collected at Entebbe, Uganda, where sleeping sickness is prevalent.

[The fact that *Glossina palpalis* does in nature transmit the trypanosome of sleeping sickness is now in the region of facts beyond dispute. But the attention of observers is at present absorbed in determining whether other species of tse-tse fly can act as carriers of the infection in nature. For a while it was believed “that species other than *palpalis* were in this respect harmless.” Certain facts, however, have since been disclosed which rendered a further investigation into the natural modes of transmission imperative. Already Taute claims to have demonstrated that *Glossina morsitans* may transmit *T. gambiense* and is of opinion that his observations show that the transmission of *T. gambiense* by *Glossina morsitans* is not an exceptional event. Even more recently Kinghorn is said to have been successful in transmitting *T. rhodesiense* (*infra*) by means of *G. morsitans*.

[The tse-tse fly is a true intermediate host of the trypanosome. Recent experiments by Bruce and his collaborators have shown that after sucking infected blood an incubation period of 28 days follows during which the bite of the fly is non-infectious and that at the end of that period the fly may become infective and may retain its infectivity for 96 days and probably for as long as it lives. There is no hereditary transmission of the parasite from one generation of fly to the next.

[The source whence the fly becomes infected is still undetermined. Bruce and his colleagues investigating this point in the ætiology of sleeping sickness have come to the conclusion that though no antelope has up till the present been found naturally infected with *Trypanosoma gambiense* these animals living in the fly-areas are potential reservoirs of the virus of sleeping sickness.]

It is possible that there are means other than the tse-tse fly by which human trypanosomiasis is spread. Martin, Leboeuf and Roubaud, for instance, consider that some mosquitos (*Stegomyia*, *Shansonia*) may take a part in the propagation of the disease: and certain facts observed in Uganda make it possible that the disease in man may be transmitted during coitus.

B. *Trypanosoma rhodesiense*.¹

Trypanosoma rhodesiense was first observed by J. W. W. Stephens early in 1910 in a case of sleeping sickness in an European from Northern Rhodesia who was being treated in the Royal Southern Hospital, Liverpool. The trypanosome was described by Stephens and Fantham.²

Stephens and Fantham believe that sleeping sickness in Rhodesia, Nyasaland, and adjoining territories is due to *T. rhodesiense* and not to *T. gambiense* recently introduced. They further believe that *T. rhodesiense* has existed in the territories above mentioned from time immemorial.

¹This section has been added.

²Stephens and Fantham, *Proc. Roy. Soc.* (1910), B, lxxiii p. 28.

Morphology.—*T. rhodesiense* is characterized by the fact that in the blood of all sub-inoculated animals the nucleus instead of being in the middle or near the middle of the trypanosome, as is usually the case, is, in some of the short or stumpy forms near the posterior end more or less close to the blepharoplast or even on its posterior side. Stephens and Fantham regard this morphological feature as in itself sufficient to distinguish *T. rhodesiense* from *T. gambiense*.

Experimental inoculation.—*T. rhodesiense* is distinguished from *T. gambiense* by its great virulence for the majority of animal species.

For rats and mice *T. rhodesiense* invariably proves fatal whereas the virulence of *T. gambiense* for these species is subject to considerable variation.

In guinea-pigs, dogs and *Macacus* monkeys the duration of *T. rhodesiense* infections is shorter than that of *T. gambiense* infections.

In sheep and goats the difference in the evolution, symptomatology and gravity of the two infections is quite remarkable. *T. rhodesiense* infections lead to an acute disease with high fever, oedema and keratitis which invariably proves fatal after a relatively short duration. *T. gambiense* infections in these animals often give rise to no symptoms except fever and usually end in recovery.

Cross immunity experiments.—Mesnil and Ringenbach immunized a *Macacus rhesus* against *T. gambiense* and then inoculated it with *T. rhodesiense*. The monkey died in 27 days. A control died in 10½ days.

Laveran immunized a goat and a mouse against *T. gambiense*; when they had acquired a solid immunity they were inoculated with *T. rhodesiense*. They became infected like the controls.

Laveran and Nattan-Larrier immunized a goat against *T. brucei*; it became infected subsequently with *T. rhodesiense*.

Laveran immunized a ram and a sheep against different strains of *T. brucei*. On inoculation with *T. rhodesiense* they both acquired acute infections and died.

The converse series of experiments are difficult to effect by reason of the virulence of *T. rhodesiense*; but the results, so far as they go, seem to show that an animal immunized against *T. rhodesiense* is immune to both *T. rhodesiense* and *T. gambiense*. This fact according to Mesnil and Légér does not invalidate the specificity of *T. rhodesiense* but tends to show that it is closely related to *T. gambiense*.

Serum reactions. *Action of immune serum.*—A goat was infected with *T. rhodesiense*. Twenty-two days later some of its serum was mixed with *T. rhodesiense* and injected into a mouse. The animal survived. A mixture of another portion of the same serum and *T. gambiense* inoculated into another mouse resulted in infection (Mesnil and Ringenbach).

Action of baboon serum.—The inoculation of 1 c.c. of baboon (*Papio anabis*) serum cured mice infected with *T. rhodesiense*. The same serum given in the same dose had very little effect on *T. gambiense* (Mesnil and Ringenbach).

Action of human serum.—In doses of 1 c.c. human serum cured *T. rhodesiense* mice in three cases out of four. On *T. gambiense* human serum had no appreciable effect (Stephens and Fantham).

Trypanolytic reactions.—The serums of animals (man, monkeys and guinea-pigs) infected with *T. gambiense* are trypanolytic for the homologous trypanosome (*T. gambiense*) but have no action on the heterologous trypanosome (*T. rhodesiense*).

Ætiology.—Both in laboratory experiments and in nature *T. rhodesiense* is transmitted by *Glossina morsitans* (Kinghorn and Yorke). In Northern Rhodesia about 16 per cent. of the wild game examined are infected with *T. rhodesiense* (Kinghorn and Yorke).

8. *Trypanosoma cruzi*.¹ *Schizotrypanum cruzi*.

When engaged upon an anti-malarial campaign in the State of Minas Geraes in Brazil in 1909 Chagas encountered a large biting insect known to the inhabitants as *Barbeiro*. This insect which belongs to the *Reduviidae* (*Conorrhinus megistus*) is about an inch or more long and lives in cracks in the walls or ceilings of human dwellings from which it only emerges in the darkness. Chagas dissected some of these bugs and found crithidial-like flagellates in the hind gut. A number were sent to Cruz who fed them upon a small striped monkey (*Callithrix penicillata*). Three to four weeks later trypanosomes of unusual appearance were found in the monkey's blood. Chagas' attention was now drawn to a disease affecting chiefly children of which the symptoms were extreme anæmia, enlargement of the superficial lymphatic glands, œdema, enlargement of the spleen and functional disturbances especially of the nervous system with frequent occurrence of actual imbecility.² In the peripheral blood of one of these cases Chagas found a trypanosome which was identical with that seen in laboratory animals infected with *Conorrhinus megistus*.

Experimental inoculation.—Monkeys (*Callithrix*), dogs, rabbits, and guinea-pigs are all susceptible to infection; *Callithrix* and guinea-pigs being more susceptible than dogs and rabbits. The disease can be reproduced either by inoculation or by allowing infected bugs to feed upon the animal.

Guinea-pigs die in 5 to 10 days. In the majority of cases the trypanosome is not found in the peripheral blood but in the lungs.

In inoculated monkeys (*Callithrix*) trypanosomes appear in the blood in about a week. The animals survive six weeks or so.

Morphology. Staining reactions.—For staining blood films Chagas used Giemsa's solution or Rosenbusch's stain.

Rosenbusch's stain.—Fix the films—whether spread with blood or with the water of condensation from blood-agar tubes—before they are quite dry in Schaudinn's perchloride solution in the cold. Wash in 50 per cent. alcohol then in water. Treat for at least 1 hour and a half in 3·5–5 per cent. iron alum. Stain for 5 minutes or more in the following solution:

1 per cent. solution of hæmatoxylin in 96 per cent. alcohol.
Saturated aqueous solution of carbonate of lithium.

Add the latter to the former until a wine colour is obtained.

Differentiate with a very dilute solution of iron alum (this operation must be watched under the microscope). Wash, dehydrate and mount in balsam.

In the peripheral blood.—In the peripheral blood the parasite may be within the red cells, partly within the red cells, merely attached to the red cells by the blepharoplast or may be free in the plasma. The parasites exhibit a sexual dimorphism. The so-called *male* parasites are relatively slender, have an elongated nucleus, a strikingly large blepharoplast and often exhibit a second mass of chromatin in front of the nucleus. The so-called *female* parasites are somewhat short and squat, the blepharoplast is situated terminally or very near the end and the nucleus consists of a loose mass of chromatin. These appearances are very similar alike in man, monkeys and guinea-pigs.

In the lungs.—Multiplication does not take place in the circulating blood. In the lungs certain multiplication forms are seen which Chagas regards as

¹This section has been added.

²The symptoms, and especially the dropsy and nervous symptoms which precede death, are so like the symptoms of ankylostomiasis that the disease is known locally as *Opilação* and *Canguary*—the names given to ankylostomiasis.

gametogony—in contradistinction to what he believes to be simple schizogony taking place in other parts of the body (*vide infra*).

In the lungs the trypanosome loses its undulating membrane, the two ends curve towards each other like a crescent and unite; the female parasites then shed the blepharoplast and in both the male and female parasites the chromatin divides into eight secondary nuclei giving rise to eight merozoites, those derived from female parasites having a single nucleus, the others having both a nucleus and a blepharoplast connected by a fine thread of chromatin. These merozoites (the precursors of the gametes found in the circulating blood) then enter a red cell and develop into typical trypanosomes. These forms have been found in man, monkeys (*Callithrix*), cats and dogs but are very uncommon in guinea-pigs.

To demonstrate the changes above described Chagas recommends that a guinea-pig should be infected with a *Conorrhinus* and that 1–2 c.c. of the blood of this first animal should be inoculated intra-peritoneally into a second guinea-pig which should be killed 5 or 6 days later.

In other structures.—Within the cells of certain other tissues, and notably in cardiac and striated muscular tissue and in neuroglia cells, the trypanosome multiplies, according to Chagas, by simple schizogony and gives origin to a great number of daughter parasites each having a nucleus and centrosome. In the cells of the central nervous system the young trypanosomes may proceed to the flagellated stage. The infected host cell is reduced to a mere envelope and the contents with the exception of the nucleus are destroyed.

In the insect carrier.—In the mid-gut of *Conorrhinus megistus* the blepharoplast approaches—and perhaps blends with—the nucleus, the undulating membrane disappears, the parasite becomes rounded and then multiplies rapidly by division. The daughter parasites become flagellated, the flagellum taking origin from the blepharoplast. In the posterior cylindrical portion of the mid-gut numerous flagellated crithidial forms are found.

On two occasions Chagas found trypanosomes in the body cavity and in the salivary glands of the bug. The latter no doubt represent the forms which are inoculated when the insect bites a susceptible animal.

Cultivation.—The parasite grows easily on Novy and MacNeal's blood-agar. The cultivation forms are similar to the forms found in the bug—round forms, rapidly dividing pear-shaped forms and crithidial forms. The parasite can almost always be sub-cultivated twice.

Ætiology.—Chagas concludes that the bug *Conorrhinus megistus* does not play a purely mechanical part in the transmission of American trypanosomiasis. The bug is not infective for at least a week after the infecting meal.

In Chagas' opinion there are two different forms of development in the bug. One—the last stage of which is represented by the crithidial forms in the mid-gut and which is always seen after the insect is fed on infected blood—is without importance. The other which is very imperfectly known probably represents the true cycle.

Detection of the parasite.—Blood films may be prepared and stained by Giemsa's and Rosenbusch's method but it is better to inoculate the blood into the peritoneal cavity of a guinea-pig.

9. Trypanosomes in birds.

Danilewsky [in 1888] was the first to give a description of trypanosomes in birds (*Trypanosoma avium*). Recent work has shown that there are several species of avian trypanosomes (Laveran, Dutton and Todd, Hanna).

A large number of birds are known to be infected; for instance owls, roller-

birds, pigeons, Indian crows, the chaffinches, the gold finches, Java sparrows (*Padda oryzivora*). The parasites are present in the blood and bone marrow.

[Petrie found trypanosomes in several species of birds at Elstree in Hertfordshire—house martins, song thrushes, blackbirds, swallows, yellow-hammers. The trypanosomes were not found in the blood but only in the bone marrow.]

The following description by Danilewsky revised by Laveran is applicable to the *Trypanosoma avium* [of the owl, *Syrnium aluco*]. The parasite is fusiform in shape and has an undulating membrane and an anterior flagellum. The cytoplasm stains deeply by Laveran's method, so deeply that the tropho-nucleus and kineto-nucleus are only just visible. The trypanosome including the flagellum is about 33–45 μ long. Multiplication takes place by longitudinal fission.

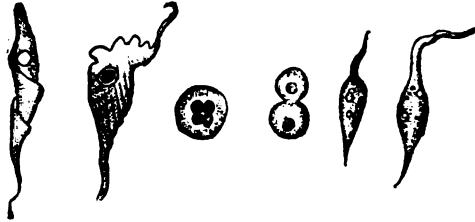

FIG. 397.—Bird trypanosomes. (After Danilewsky.)

The trypanosome can live 5–8 days in blood kept aseptically in a pipette at a temperature of 22° C. Under these conditions Danilewsky has observed spherical bodies which divide and give rise to spherical amoeboid bodies each having a nucleus: these bodies become pyriform and a very motile flagellum appears at their anterior extremities (*Trypanomonas*, Danilewsky). After a certain lapse of time these new forms assume the characteristic appearances of the trypanosome.

In addition to *T. avium* other trypanosomes are found in birds, e.g. trypanosomes of the type *T. rotatorium* of frogs, and long slender trypanosomes with no free flagellum.

10. Trypanosomes in cold blooded vertebrata.

Trypanosomes have been found in Batrachians, reptiles and fish.

Trypanosomes in frogs.—Many species of trypanosomes are found in frogs. The most widely distributed is *Trypanosoma rotatorium* (*Undulina ranarum* [Ray Lankester], *Trypanosoma sanguinis* [Gruby]) which has been studied by Glüge, Danilewsky, Mayer, Gruby, Chalachnikow, Ray Lankester and others. It is found, especially in summer, in *Rana esculenta*, *R. viridis*, *Hyla viridis*, *Bufo vulgaris*, etc.

T. rotatorium varies much in size and shape. There is a flat form enrolled on itself; a simple flat form, membranous, very active; pectinated forms either fan-shaped or in the form of a cornucopia, etc. In length it varies from 40–60 μ and even 75 μ , and in width from 5–40 μ . It is the largest of all the known trypanosomes (Laveran and Mesnil).

The cytoplasm contains a nucleus and a centrosome always situated close together, the nucleus being anterior to the centrosome. The undulating membrane is very much folded and its free border is continued anteriorly as the flagellum.

Trypanosomes in fish.—Trypanosomes were discovered in fish by Valentin in the blood of [a trout] *Salmo fario*, and they have since been found by Remak, Mitrophanow, Danilewsky, Chalachnikow, Lingard and others in [a loach] *Cobitis fossilis*, [the Prussian carp] *Carassius vulgaris*, [carp] *Cyprinus carpio*, *Perca fluviatilis*, and other fish.

Laveran and Mesnil have found Trypanosomes in sea fish: [ray] *Raja punctata*, *R. mosaica*; [small dog-fish] *Scyllium canicula*, and [large dogfish] *Sc. stellare*; [sole] *Solea vulgaris*.

Chalachnikow distinguishes two varieties of trypanosomes in fish; one similar to *T. avium*, the other, flat and not folded, like *T. rotatorium*. Numerous species are now described: *T. remaki*, *T. dansilewskyi*, *T. abramis*, *T. rajæ*, *T. soleæ*, etc.



FIG. 398.—Fish trypanosomes. (After Chalachnikow.)

For the detection of the parasites in the blood, Laveran and Mesnil advise collecting a few drops of blood by incising two or three rays at the base of the dorsal fin. The blood should be examined between a slide and a cover-glass. Mixing the blood with a little citrated normal saline solution prevents coagulation and preserves the motility of the parasites.

For preparing stained preparations the living fish must be opened and some of the heart blood collected in a pipette: the blood is then to be spread on slides in a thin layer, rapidly dried over the flame of a spirit lamp and then fixed in absolute alcohol or in alcohol-ether.

SECTION II.—TRICHOMONAS VAGINALIS.

Syn.—*Cercomonas intestinalis*. *Trichomonas intestinalis*.

It is now generally conceded that the parasites described under the names of *Cercomonas hominis* (Davaine), *Cercomonas intestinalis* (Lambl), *Trichomonas intestinalis* (Leuckart), etc., should be regarded as a single species: *Trichomonas vaginalis* (Donné, Blanchard).

Trichomonas vaginalis was discovered by Davaine in the dejecta of persons suffering from cholera. It is frequently to be found in the stools of patients suffering from diarrhoea due to very different diseases. It has been found in the viscous fluid surrounding an hydatid cyst of the liver (Lambl), in cases of gangrene of the lung, hydropneumothorax, etc. It is frequently present in the vagina in cases of vaginitis in married women and virgins, but not in normal alkaline vaginal mucus. It has been found in the bladder.

In some cases of dysentery *Trichomonas* is found in very large numbers (Castellani, Terry, Chassin, Billet) and may be found in association with *Amœba histolytica*. The part it plays in disease processes is not clear: there is no proof that alone it can give rise to dysenteriform ulceration. It is conceivable that it may find a suitable soil for development in, and may perpetuate, some pre-existing lesion.

According to Perronçito, the parasite gains entrance to the alimentary canal in drinking water, in which it occurs in an encysted form.

Morphology.—*Trichomonas vaginalis* measures 12–25 μ long by 7–12 μ broad. Its shape is very variable; it is generally pyriform, though sometimes pointed, sometimes curled up into a rounded ball, and sometimes constricted in the centre like an hour-glass. The larger anterior end is furnished with three sessile flagella directed forwards all attached at the same point and frequently matted together: there is a fourth flagellum turned backwards forming the free margin of a slightly raised, folded and scalloped undulatory membrane which extends to the posterior end of the organism. The posterior end is most frequently provided with a caudal appendage of

variable length: the mouth opens near the insertion of the flagella and leads to a tubular cavity in the protoplasm.

The rounded and elongated nucleus and the blepharoplast are situated in the granular protoplasm near the mouth. A slender hyaline rod is seen near the middle of the body.

The shape of the parasite is subject to considerable variation and on occasions it throws out pseudopodia. In the intestine (mucus from a case of dysentery) Ballet has seen a number of *Trichomonas* agglutinated together



FIG. 399.—*Trichomonas vaginalis*.
(After Grassi.)

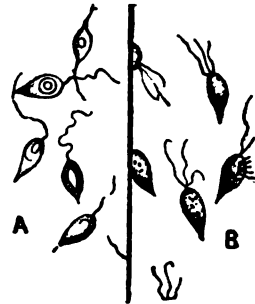

FIG. 400.—A, *Cercomonas intestinalis* (after Davaine); B, *Trichomonas vaginalis*. In this figure A and B are really identical. In A, the parasites show only a single flagellum the others have been accidentally destroyed. The flagella pictured on one of the parasites in B are merely artefacts due to the tearing of the undulating membrane.

in a regular-shaped rosette, the individuals forming which soon become changed into large, vacuolated, slightly motile, amœboid masses each having a nucleus placed excentrically.

Reproduction is by longitudinal division.

Methods of examination.—Examination of the parasite is difficult on account of its extreme motility and the details of its structure can only be studied after fixing by one of the methods described when dealing with the amœbæ.

Search must be made for *T. intestinalis* in stools while they are still warm, as the parasite quickly dies when they cool. In carrying out this investigation all the precautions mentioned when dealing with the amœbæ must be observed, and if need be the stools should be diluted with luke-warm normal saline solution or Grassi's solution.



FIG. 401.—*Cercomonas termo*.

Other species of *Trichomonas*.

***Cercomonas termo*.**—*Cercomonas termo* is an excellent species for the study of these Protozoa. It occurs in large numbers in vegetable infusions.

Cercomonas termo consists of an oval body having at one end a long, very motile flagellum.

Food stuffs are introduced into the protoplasm at the cytostome or mouth situated at the base of the flagellum; at this point the ectoplasm is interrupted and the protoplasm is vacuolated; food stuffs are collected in the vacuole which extends to the centre of the body, and here the ingested particles are digested. Foreign bodies other than food particles which may have been ingested are rejected at the same point at which they were absorbed (Bütschli).

Reproduction is by binary longitudinal fission. The nucleus divides first and is

followed by division of the protoplasm in the neighbourhood of the flagellum: the two daughter cells gradually separate and a flagellum develops on the part which has been deprived of it.

Trichomonas caviae.—This parasite is responsible for certain epizootic diseases among guinea-pigs (Galli-Valerio). The protozoon is found in large numbers on the epithelial surface of the intestine.

Trichomonas batracorum.—*T. batracorum* lives in the intestines of frogs. It is elongated and spindle-shaped, the anterior end being larger than the posterior and provided with two or three flagella. The posterior end has a long flagellum attached laterally. The undulating membrane, the free edge of which is serrated like the teeth of a saw, extends from the anterior extremity to the base of the posterior flagellum.

Monas pyophila.—This parasite has been found in the pus of a liver abscess in Japan by Grimm. In appearance it is like that of a large spermatozoon (30–60 μ long) prolonged at one end in the form of a long appendix which terminates in a flagellum.

Bodo urinaris.—This flagellate grows easily in alkaline urines; it appears to be an harmless organism and probably occurs in the encysted form in atmospheric dust, and gains access to urine after the latter has been passed. It has been described by Hassal, Salisbury, K nstler, Barrois and others and is variously known as *B. urinaris*, *Plagiomonas irregularis*, *Pl. urinaria*, *Cystomonas urinaria*.

It has an oval-shaped protoplasmic body (12–15 μ \times about 8 μ), the anterior end being the larger and carrying two flagella: the posterior end is prolonged into an elongated retractile point.

SECTION III.—LAMBLLIA INTESTINALIS.

Synonym.—*Megastoma entericum*.

This parasite was discovered by Lambl in the mucus in the stools of young children. It has since been frequently found in the stools or intestinal contents of persons in good health and in others affected with various diseases, and especially in young children and persons suffering from tuberculous phthisis: it inhabits preferably the duodenum and jejunum. Noc has recorded its occurrence in the stools of persons suffering from Cochin China diarrhoea. *Lamblia* do not appear to be pathogenic. Sometimes they are so numerous as to cover a large part of the mucous membrane of the small intestine; in a patient affected with chronic gastric catarrh Moritz and Holzl estimated the number of parasites evacuated in 24 hours to be 18 thousand millions. *Lamblia* are also found in the dog, cat, sheep, rabbit, rat, mouse, etc.

Morphology.—*Lamblia intestinalis* is pyriform in shape and measures 10–20 μ long by 5–10 μ broad. On one side of the larger extremity it presents a cup-shaped depression. There are four pairs of flagella; the first pair take origin from the anterior extremity, the second and third pairs from the posterior end of the depression while the fourth pair are attached to the pointed posterior end of the parasite: these flagella measure 7–14 μ long, are directed backwards and are capable of varied movement.

The protoplasm is generally granular: it possesses a nucleus situated transversely and having the shape of a dumb-bell or an horse-shoe.

In the intestine the parasite occurs on the surface of the villi and attaches itself by means of the sucker to the epithelial cells, its posterior extremity being then vertical to the surface or directed forwards. In the intestine

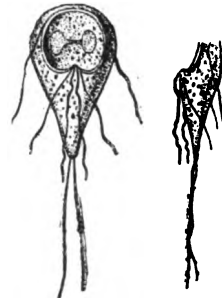

FIG. 402.—*Lamblia intestinalis*. (After Grassi and Schewiakoff.)

Lamblia multiplies by fission. Dissemination is effected by means of oval cysts which are discharged in the stools, infection taking place through drinking water or foods infected with the cysts. Calandruccio infected himself by swallowing a number of cysts recovered from the stools of an infected person: mice and rats (*Mus decumanus*) have been infected by the same means (Perroncito, Grassi).

Methods of detection.—The technique to be adopted is that described for the amœbæ.

CHAPTER LXIII.

THE INFUSORIA.

Introduction and methods of examination.
Parasitic species, p. 830.

THE Infusoria are Protozoa the bodies of which are wholly or in part covered with motor appendages or cilia. They have a distinct ectoplasm and endoplasm, contractile fibres, contractile vacuoles, and a nucleus divided into two parts (macronucleus and micronucleus). In addition they have a mouth, a pharynx opening into the endoplasm and an anus which is only visible at the moment of expulsion of the excreta.

They multiply generally by transverse division. After several generations have been produced by fission the individuals show a tendency to conjugate, and after certain changes have taken place in the nucleus of the two conjugated individuals the latter separate and each may then become the parent of a further generation of schizogonic elements.

In the stools and outside the body cysts are produced: the animal loses its cilia, becomes rounded and appears to consist of a dark central mass surrounded by a clearer peripheral zone. The cyst is the latent form of the organism which again becomes ciliated when conditions are favourable.

Five species of Infusoria are known which occur as parasites in man.

Methods of examination.—The technique to be adopted is similar to that described in the case of the Amœbæ. For detailed study of their structure it will be found useful to stain the Infusoria in the living state, either with a solution of quinolein blue (which stains the granules of the endoplasm but neither the nucleus nor the cilia) or with Bismarck brown (which stains the vacuoles first then the protoplasm but leaves the nucleus unstained). Violet dahlia or malachite green may be used for staining the nucleus. The dyes should be dissolved in the fluid in which the Infusoria are living (normal saline solution) and the solutions should be weak (about 1 in 10,000).

For fixing the Infusoria, osmic acid gives the best results. The vapour of the acid should be allowed to act on the slide on which the drop of water containing the parasites is placed: or a drop of a 1 per cent. solution of osmic acid may be placed on a cover-glass and inverted on to the water on the slide.

Tissues intended for histological examination should be fixed in Flemming's solution or in 30 per cent. formalin: the methods of staining are the same as for the Amœbæ.

Balantidium coli.

(Paramœcium coli.)

This protozoon is found in the intestines and stools of man and pigs: it was first described by Malmsten but it appears to have been previously seen by Leeuwenhoek in the excreta.

It would seem to have been proved that *Balantidium coli* may produce disease: it has been found in numerous cases of catarrhal colitis and ulcerative dysentery in man in America, the Philippines, Finland, Bothnia, Russia, Germany, etc. (Russell, Losch, Strong and Musgrave, and others).

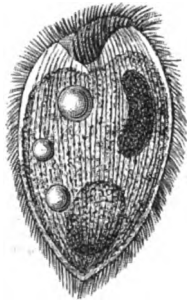
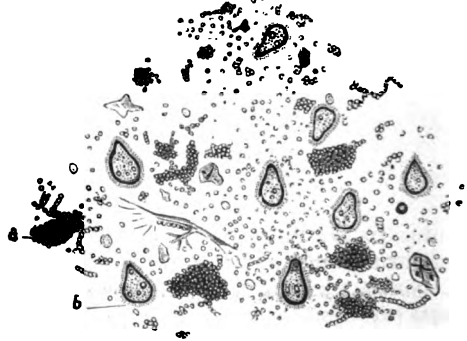
FIG. 403.—*Balantidium coli*.FIG. 404.—*Balantidium coli* in stools. (After Gulart.)

Askanazy, and Klimenko have shown that not only is *Balantidium coli* found in extraordinarily large numbers in ulcerative lesions of the intestine but that it finds its way into the deep layers of the colon, into healthy tissues and even into small blood and lymph vessels: this power of penetration explains the finding of the parasite by Manson and Stockvis in liver abscesses. [Brooks attributed a fatal epizootic of dysentery among the orang-outangs in the zoological gardens at New York to this parasite.]

It is necessary, however, to point out that up till now it has not been possible to produce experimentally in man or in monkeys an ulcerative colitis with *Balantidium coli*. Grassi and Calandruccio failed to infect themselves by swallowing cysts of *Balantidium coli* obtained from a pig.

Morphology.—*Balantidium coli* is an oval-shaped organism measuring from 70–100 μ long which can be seen with the unaided eye: its surface is covered with short, delicate vibratile cilia arranged in regular longitudinal lines.

At the narrower end of the body there is a mouth or *cytostome* destined to receive the food, and at the larger end a second orifice or *cytopyge* for the removal of the waste products of digestion. Around the mouth the cilia are grouped in a ring or collar and move in such a way as to direct food material towards the mouth. The arrangement of the nucleus is characteristic: the macronucleus has the shape of an haricot bean in the concavity of which the rounded micronucleus is situated. The protoplasm contains two or three contractile vacuoles in which ingested materials of external origin such as blood cells, starch granules, fat droplets, etc. are frequently found.

The cysts are spherical (*vide ante*) and measure 80–100 μ across. They are found in cold and dried excreta.

Balantidium minutum.

This parasite was first discovered by Jacobi and Schaudinn at Strasbourg in the intestines of a ship's cook. It has since been found in Berlin twice (once in association with *Nyctotherus faba*), and in Porto Rico in several cases of dysentery together with *Balantidium coli*.

It is pyriform in shape and only measures $20-30\mu \times 15-20\mu$. The macronucleus is spherical and situated centrally, the micronucleus is attached to it. There is only one contractile vacuole.

Colpoda cucullus.

This parasite is very commonly found in marshes and can live in the human intestine: it was found by Schultz in the intestine of a person suffering from dysentery. Morphologically it is very like *Balantidium minutum* with which it is possibly identical.

[Stokvis and Swellengrebel have shown that living *Colpoda cucullus* will purify water of bacteria present in it.]



FIG. 405.—*Balantidium minutum*. (After Schaudinn.)

Nyctotherus faba.

This parasite was twice found by Jacobi and Schaudinn once in Berlin and once in Strasbourg. It has the shape of a haricot bean: the mouth occupies the anterior one-half of the concave side. The macronucleus is spherical and has the micronucleus attached to it. It has only a single contractile vacuole (fig. 406).

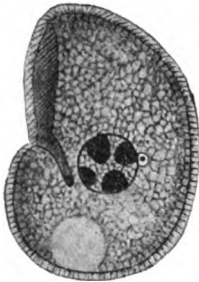

FIG. 406.—*Nyctotherus faba*. (After Schaudinn.)

Chilodon dentatus.

This organism was found by Guiart in Paris in the stools of a woman suffering from dysenteric colitis. Its common habitat is water. The parasite is an oval-shaped Infusorium ($35-55\mu \times 25-35\mu$), the ventral surface being flattened and the dorsal markedly convex. At its anterior part it shows a flexible and membranous prolongation of the ectoplasm having several rows of long flagella on its lower surface. The ventral surface of the parasite appears to be covered with very short flagella while the dorsal surface is bare. The mouth is centrally placed towards the anterior part of the endoplasm: its margins are covered by chitinous rods. The macronucleus is rounded and situated towards the posterior part of the body: the micronucleus is attached to it. There are two contractile vacuoles one in front of, the other behind, the nucleus.

PART VI.
THE FILTRABLE VIRUSES.

CHAPTER LXIV.

THE FILTRABLE VIRUSES.

Introduction.

Section I.—The virus of Pleuro-pneumonia in cattle, p. 836.

Section II.—The virus of Foot and Mouth disease, p. 838.

Section III.—The virus of Horse-sickness, p. 838.

Section IV.—The virus of Rinderpest, p. 839.

Section V.—The virus of Bird-plague, p. 839.

Section VI.—The virus of Sheep-pox, p. 839.

“The infectious epithelioses,” p. 840.

Section VII.—The virus of Cow-pox p. 840.

Section VIII.—The virus of Yellow fever, p. 841.

Section IX.—The virus of Rabies, p. 841.

Section X.—Filtrable viruses in the Pasteurelloses, p. 842.

Section XI.—The virus of Swine fever, p. 843.

Section XII.—The virus of Acute anterior poliomyelitis, p. 844.

Section XIII.—The virus of Typhus fever, p. 847.

PASTEUR put forward the opinion that some micro-organisms were so small as to escape the ordinary method of microscopical investigation; recent research has proved the truth of this hypothesis, and has shown moreover that micro-organisms too small to be seen with the microscope are responsible for a number of diseases. The use of dark-ground illumination has not hitherto given any interesting results in this connexion.

It is characteristic of the filtrable viruses that they can pass through certain porous porcelain or similar filters and for this reason they are sometimes known as “filter passers.”

To demonstrate this property too fine a filter must not be used: a Berkefeld V or Chamberland F are the most suitable for the purpose though occasionally a more porous bougie is employed (Chamberland F_1 to F_{10} made to the instructions of Borel, or Berkefeld V worn down on a grindstone or with a glass cutter).

The virus is prepared as follows: Dilute the infected material (defibrinated blood, serous exudate, emulsion of internal organs, etc.) with water in which a culture of an easily-recognized micro-organism preferably a motile organism—has been emulsified: this organism acts as a control. Filter the emulsion under a low pressure. On cultivation the filtrate should yield no visible growth but on inoculation into a susceptible animal should give rise to the original disease.

In experiments with ultra-microscopic viruses certain conditions must be strictly observed. The filter should be new and must be sterilized before use: the process of filtration should occupy not more than about 2 hours: the pressure applied—

whether by compression or aspiration—should be as small as possible (in the former case, say, the pressure produced by an india-rubber syringe, and in the latter that equivalent to 50–500 mm. of mercury): the experiment should be carried out at the ordinary temperature of the atmosphere and if possible not above 20° C.: the emulsion should be diluted so as to avoid blocking the pores of the filter with the albuminous matter present: and finally, since even those ultra-microscopic viruses which are most easily filtered are partially retained in the filters, several animals should be inoculated each with a large volume of the filtrate.

SECTION I.—PLEURO-PNEUMONIA OF CATTLE.

[*Pleuro-pneumonia contagiosa.*]

All attempts to demonstrate the micro-organism of contagious pleuro-pneumonia in cattle failed until Nocard and Roux in 1898 devised a new method of investigation (*vide post*) which resulted in the discovery of the organism. “The discovery of the cause of pleuro-pneumonia,” wrote these observers, “is interesting not only because peculiar difficulties have been overcome but because it affords hope that a similar success may attend the study of those other diseases of which the micro-organism is up till the present unknown.”

Pleuro-pneumonia of cattle may run either an acute or a chronic course. In the acute form of the disease the respiratory symptoms are the most marked: the respiratory movements are increased in frequency and are shallow, friction sounds can be heard as well as rhonchi denoting bronchial disease, and there is a frequent cough and running from the nose; the animal ceases to chew its cud and loses its appetite: the disease may resolve, become chronic, or may terminate fatally. In the chronic form of the disease—which may either begin as such or follow an attack of the acute form—a considerable area of the lungs is congested and hepatized: as a rule, the disease is incurable.

The essential lesion in pleuro-pneumonia is the distension of the meshes of the inter-lobular connective tissue with a large amount of clear amber-coloured fluid.

1. Experimental inoculation. Vaccination.

Willens has shown that the exudate in pleuro-pneumonia will reproduce the disease on inoculation into bovine animals. Goats, sheep, pigs, dogs, guinea-pigs, rabbits and birds are immune.

The inoculation of a drop of the fresh serous exudate from a case of pleuro-pneumonia into the sub-cutaneous tissues of a cow is followed, after an incubation period of from 8–25 days, by a disease the severity of which will depend upon the site of inoculation.

(i) When the material is inoculated beneath the skin of the trunk or neck, the temperature of the inoculated animal becomes very much raised and is accompanied by an enormous but painless inflammatory swelling which may extend throughout the cellular tissue of the trunk. Most frequently the disease is fatal, but if the animal recover it will be immune both to inoculation and to the spontaneous disease. If the animal die, the meshes of the connective tissue are found, *post mortem*, to be distended with a clear serous fluid which is present in such large amount that occasionally several litres can be collected. The œdema never affects the lungs or internal organs: the animal dies of an intoxication.

(ii) If, on the other hand, the inoculation be made into the dense cellular tissue at the tip of the tail, the disease is usually benign; the swelling at the site of inoculation is very little marked and not extensive, and in the great majority of cases the illness which follows is slight and the animal quickly recovers; it is then found to be immune.

Vaccination.—Willens applying these observations vaccinated animals against pleuro-pneumonia by inoculating a drop of the pulmonary exudate into the cellular tissue of the tail. As the exudate quickly loses its virulence a practical difficulty was at first experienced, for the exudate had to be collected from a recently killed animal; but after Pasteur had demonstrated that the exudate when collected with aseptic precautions will retain its properties for several (up to 4) weeks vaccination became an easier matter. If the exudate be inoculated 4–6 weeks after collection it produces no effect; hence the necessity, in countries where prophylactic vaccination is a regular practice, of having vaccination centres where calves can be inoculated and the fresh material collected at least once a month (but vaccination is now effected with pure cultures (*vide infra*)).

2. Methods of diagnosing the disease—Characteristics of the organism.

The microscope and the ordinary methods of cultivation being of no use in searching for the micro-organism in pleuro-pneumonia, Nocard and Roux cultivated the exudate in collodion sacs.

Collodion sacs (p. 175) are filled with broth, sown with a drop of the exudate from a case of pleuro-pneumonia and introduced into the peritoneal cavities of rabbits. After remaining there for a fortnight or 3 weeks their contents are cloudy, opalescent, and slightly albuminous.¹

Microscopical examination of this cloudy fluid with a magnification of about 2000 diameters shows that it contains a large number of motile refractile points but so small that their shape cannot be made out and they cannot be stained.

The virus is not without effect upon the rabbits used for the experiments: when the sacs are removed after 15–20 days the animals are found to be very thin, and they occasionally die before the twentieth day in a state of extreme emaciation but without any appreciable lesion: their organs and body-fluids are sterile. The control animals in which similar but sterile sacs are inserted remain healthy. The symptoms are evidently of the nature of a toxæmia, which must be due to the diffusion of products elaborated by the micro-organism: and the experiment shows that the rabbit is susceptible to the toxin though it is immune to the organism itself.

The contents of the collodion sacs removed from the rabbits cannot be cultivated on ordinary culture media. The vitality of the virus can be preserved by keeping it in collodion sacs in the peritoneal cavities of these animals, but its virulence appears to diminish in the process.

The organism cannot be grown in collodion sacs in the peritoneal cavities of guinea-pigs.

After a long series of experiments, Nocard and Roux have succeeded in devising an artificial medium on which the micro-organism of pleuro-pneumonia can be grown *in vitro*. The medium is a mixture of twenty parts of Martin's peptone solution (p. 32) and one part of rabbit or cow serum. Tubes of this mixture sown aërobically with a drop of the exudate from a case of pleuro-pneumonia or with some of the contents of a collodion-sac culture, and incubated at 37° C. give a growth similar to that obtained in collodion sacs: moreover the micro-organism retains its virulence on this medium and a long series of sub-cultures can be made.

By adding agar to the above solution a solid medium can be obtained on which after incubating for 3 or 4 days the organism of pleuro-pneumonia gives very minute colonies. When the colonies are very closely packed

¹ The contents of control sacs, prepared in the same manner but not sown with the exudate remain clear under similar conditions.

together they form a hardly visible roughening of the surface of the agar: when sufficiently far apart they may attain the size of a pin's head. These colonies can be stained *en masse* and if they be transferred intact to a slide, preparations can be obtained which stain with the ordinary aniline dyes and are gram-positive.

The inoculation of cows with cultures obtained by Nocard and Roux's method is followed by a typical attack of the experimental disease: occasionally the animal dies: when it recovers it is immune to inoculation with cultures or with the exudate from a case of pleuro-pneumonia. Pure cultures are now used in place of the serous exudate for the purpose of Willens' vaccination (*vide ante*).

Filtration.—If the exudate from a case of pleuro-pneumonia be filtered through a Chamberland (F) or Berkefeld bougie, the filtrate does not produce the disease in calves neither does it give cultures: but, on the other hand, if the same exudate be diluted with 20–30 volumes of water the filtrate is infective and grows on serum-broth; under these conditions the organisms pass through the filters (save Chamberland B through which they never pass).

Filtration thus enables a pure culture of the organism to be obtained from contaminated exudates, ordinary bacteria being held back by the filter.

SECTION II.—THE VIRUS OF FOOT AND MOUTH DISEASE.

(Aphthous fever.)

Foot and mouth disease infects cattle, sheep, goats, and pigs and is transmissible to man.

Microscopical examination and cultural methods fail to reveal the presence of any micro-organism in the lymph contained in unbroken vesicles, but this lymph is nevertheless infective and on inoculation into cattle, pigs, sheep and goats will reproduce the disease.

Lœffler and Frosch have shown that the virus of foot and mouth disease is an invisible organism, which easily passes through a Berkefeld bougie if care be taken to dilute the serous fluid with 40–50 volumes of water but is held back by closer filters such as Kitasato's bougie and Chamberland B.

Vaccination. Serum therapy.—Aphthous lymph loses its infectivity if kept for some time (3–8 weeks), or if heated (12 hours at 37° C. or 30 minutes at 60°–70° C.). By inoculating into the veins of an ox a mixture of an old inactive lymph and fresh lymph attenuated by heating at 60° C. for 5 minutes Lœffler has been able to produce an immunity to the disease, but this immunity is only acquired slowly. By hyper-immunizing oxen with increasing doses of an active lymph of constant virulence, Lœffler obtained a serum which has some slight prophylactic properties.

When a stable is found to be infected and infection of all the animals in it has become inevitable, recourse may be had to an emergency inoculation: all the animals are purposely infected in such a manner as to secure that they shall suffer from the least severe form of the disease. For this purpose the tongues and the inner surface of the lips of the healthy animals are rubbed with a rough cloth soaked in virulent saliva.

SECTION III.—THE VIRUS OF HORSE-SICKNESS.

Horse sickness is a fatal disease affecting horses in South Africa which can be experimentally inoculated and though not spontaneously contagious is apparently transmitted by biting insects.

The blood and the pulmonary and conjunctival exudates are infective. No micro-organisms have been demonstrated in these fluids neither have organisms been cultivated from them.

The filtrate obtained by filtering the undiluted exudate or blood mixed with serum through a Berkefeld or Chamberland F bougie will reproduce the disease on inoculation into a susceptible animal (McFadyean). The virus will pass through a Chamberland B bougie provided that the exudate has been diluted with 30 volumes of water.

In places where horse-sickness is prevalent a very similar disease is observed in sheep, goats and cows. This latter disease is known as catarrhal fever of sheep (blue tongue, mouth sickness, heart-water, catarrhal malarial fever, etc.): it appears to be different from horse-sickness, and is also caused by a "filter passer." The filtrate obtained by filtering the blood or serum (Berkefeld bougie) is infective (Theiler and Robertson).

SECTION IV.—THE VIRUS OF RINDERPEST.

(Cattle plague.)

Rinderpest is essentially a disease of bovine animals, but it also affects some races of sheep, goats and pigs. The blood, exudates and juices from the internal organs are infective, but the causal micro-organism can neither be seen nor cultivated. The virus easily passes through a Berkefeld bougie and, under certain conditions and with difficulty, through a Chamberland F bougie.

SECTION V.—THE VIRUS OF BIRD PLAGUE.

Bird plague must be carefully distinguished from fowl-cholera (Centanni and Savonuzzi). The disease, which is fairly widely distributed, may affect all farm-yard birds and especially pheasants; it is due to an invisible organism (Maggiara and Valenti). The pleural, pericardial and peritoneal exudates and the blood of diseased birds are infective. The virus will pass through a Berkefeld or Chamberland F bougie and even through Chamberland B.

Marchoux has succeeded in growing the virus of bird plague: after ten successive sub-cultures, a dose of 0.20 c.c. of the blood in which the virus was sown killed fowls in 2 days. The cultures are grown at 37° C. in defibrinated fowl blood spread on a thick layer of glucose-peptone-agar: growth does not take place through the whole of the blood but only in a zone near the surface of the agar.

SECTION VI.—THE VIRUS OF SHEEP-POX.

Synonym.—*Variola ovina*; Fr. *La Clavelée*.

The virus is present in the pustules and in all the lesions of sheep-pox. No organism has been discovered. The virus cannot be cultivated and does not remain in the blood.

The juice obtained by scraping the pustules when diluted with water and filtered through a Berkefeld bougie will yield an infective filtrate. The virus will not pass through a Chamberland F bougie if the material be filtered rapidly and at once, but if the filtration be carried on continuously for from 1-7 days the virus will then appear in the filtrate (Borrel).

When the virus is diluted with non-sterilized tap water a number of very small vibrios and spirilla pass through the bougie with the virus of sheep-pox: these water organisms (which can be stained by Loeffler's method, p. 149) multiply in

the filtrate when it is kept at 20° C., but will not grow in ordinary broth. The filtrate as the result of the multiplication of these organisms becomes slightly opalescent. Under similar conditions, the filtrate occasionally contains certain structures which Borrel regards as belonging to the Protozoa and to which he has given the name *Micromonas mesnili*.

With the object of protecting sheep against sheep-pox the animals are immunized by infecting them with a mild form of the disease. Vaccination [or clavelization] is effected by inoculating a small quantity of lymph from the pustules with a lancet on the tail or on the internal surface of the ear.

The inoculation is not without danger: some of the animals die (1-10 per cent.). Borrel hyper-immunized sheep which had recovered from sheep-pox by inoculating them on several occasions with lymph from the inoculation pustule, and obtained a serum which had prophylactic and therapeutic properties: the inoculation of 10-20 c.c. of this serum has arrested the mortality in flocks exposed to infection.

"Infectious epithelioses."

Borrel has introduced the term "infectious epithelioses" to denote a number of diseases having a special affinity for the epithelial tissues and caused by "filter-passing organisms": sheep-pox, cow-pox, foot and mouth disease, rinderpest, *epithelioma contagiosum* of fowls and *molluscum contagiosum*. In sheep-pox there is always present a characteristic and specific element, the *sheep-pox cell*, having a vacuolated nucleus with pseudo-parasitic inclusions (due probably to the penetration of poly-morpho-nuclear cells which in these cells undergo a process of degeneration). wherever the virus settles it produces a proliferation of the epithelial tissues, and (in the liver, kidney and lung) epithelial growths which develop at the expense of the pre-existing cells of the part. There can be no doubt but that these changes bear a considerable resemblance to the evolution of cancer growths, so that the hypothesis might be put forward that the cancer virus enters into the category of filter-passing organisms. This is merely an hypothesis, and it must be noted, as Borrel says, that the metastases of sheep-pox are absolutely different from cancer metastases: for example, the metastases in the lung in the former case represent a proliferation of pre-existing cells, while cancer metastases are produced by a graft in the lung of cancer cells from the original tumour.

SECTION VII.—THE VIRUS OF COW POX.

[*Variola vaccinia*.]

If the fresh exudate from the vesicles of an heifer suffering from cow pox be rubbed up with 10-12 times its weight of water and filtered through a Berkefeld V bougie a filtrate is obtained which according to many investigators has proved to be infective.

The virulence is only manifested if before filtration the lymph is left to macerate for a long time in sterile water (Carini, Negri). The first emulsion of lymph is left in the ice chest for 2 or 3 days then rubbed up and replaced in the ice chest for a fortnight. It is not until now that the product is filtered, first through wool then through paper and finally through a Berkefeld bougie.

Negri soaked up the filtrate on a small piece of sterile absorbent wool and placed it on the cornea of a rabbit (which had been previously scarified) for about 10 hours. A typical pustule developed the contents of which were infective and produced similar effects on the corneæ of other rabbits in series, and on the skin of a calf. With a similar filtrate Remlinger and Osman Nouri have been able to produce a typical vaccinal eruption on the shaved skin of guinea-pigs and rabbits.

In these investigations, the inoculations should be performed on a number of animals: for the virus is partially retained by the bougie, and the filtrate is consequently not highly infective (p. 836).

The filtrate inoculated beneath the skin of a susceptible animal immunizes

the latter against vaccine lymph. This fact, which was first shown by Casagrandi and has also been observed by Rouget, and by Remlinger and Osman Nouri, again demonstrates that the virus will pass through porcelain or similar filters.

Rouget experimented on ten heifers, by inoculating 40 c.c. of the filtrate beneath the skin: the test inoculation was carried out a week later with glycerin lymph with which controls were also inoculated. He obtained four positive results.

SECTION VIII.—THE VIRUS OF YELLOW FEVER.

In yellow fever the blood is infective, and if inoculated into an healthy man leads to the development of the disease (Reed, Carroll, Agramonte). The disease is transmitted by a mosquito (*Stegomyia fasciata*): after feeding on the blood of a yellow fever patient this mosquito can infect a healthy man.

Reed, Carroll and Agramonte have shown that yellow fever is due to an invisible micro-organism. From their experiments, which have been confirmed by those of Parker, Beyer and Pothier, Rosenau, Marchoux, Salimbeni and Simond, it follows that serum or defibrinated blood from a case of yellow fever diluted with an equal volume of water and filtered through a Berkefeld or Chamberland F or B bougie will yield an infective filtrate. The virus seems to pass through filters quite easily and in most cases a dose of the filtrate corresponding to 0.5–1 c.c. of serum has been sufficient to cause typical yellow fever in man.

SECTION IX.—THE VIRUS OF RABIES.

(Hydrophobia.)

Remlinger and Riffat-Bey have shown that the virus of rabies will readily pass through a Berkefeld V and even a W or N and Chamberland F: their experiments were carried out with the brain of a rabbit made into an emulsion with 300 c.c. of water. Similar results have been obtained by di Vestea, Schüder, Bertarelli and Volpino, de Blasi and Celli.

Peculiar polychromatic structures never seen in normal tissues have been described by Negri in the central nervous system of man and the lower animals which have succumbed to rabies.

These structures, which are invariably intra-cellular, occur in the pyramidal cells of the *cornu ammonis*, in the cells of Purkinje, in the cerebellum and in the large cells of the cerebral convolutions: they are not found, or only very rarely indeed, in the cells of the *pons varolii* and *medulla oblongata*. They are generally round or oval and measure from 10–25 μ in diameter: occasionally they are much smaller and only measure 0.5–1 μ or less. They stain an intense bright red by Fasoti's method.

Fasoti's method.—1. Fix small pieces of the tissue for 24–48 hours in Foa's solution (Müller's solution, 100 c.c.; perchloride of mercury, 2 grams) or in acid perchloride (p. 189).

2. Wash rapidly in water. Freeze and cut. If a precipitate be produced it can be removed by washing in iodine-alcohol.

3. Stain the sections for 5–10 minutes in 0.5 per cent. solution of eosin, heating gently. Wash in water.

4. Differentiate until the sections acquire a pink tint in the following solution:

| | | | | |
|---|---|---|---|----------|
| 1 per cent. aqueous solution of caustic soda, | - | - | - | 4 drops. |
| 90 per cent. alcohol, | - | - | - | 50 c.c. |

Wash in water.

5. Stain in a 0.25 per cent. aqueous solution of methylene blue until the sections are pale violet in colour.

6. Wash for 1 or 2 minutes in 50 per cent. alcohol, pass rapidly through absolute alcohol, and xylol. Mount in balsam.

Celli, and de Blasi, and others regard the Negri bodies as parasites which at a certain stage in their life history are so small as to be capable of passing through filters, and consider that it is these minute forms which originate the infection. Remlinger holds that the Negri bodies are merely changes in the nerve cells following the infection of the latter by the ultra-microscopic parasite of the disease.

SECTION X.—FILTRABLE VIRUSES IN THE PASTEURELLOSES.

1. **Distemper.**—Carré by filtering the nasal discharge of dogs infected with distemper obtained a liquid which though apparently sterile produced all the symptoms of distemper when inoculated into young dogs. [M'Gowan has isolated a gram-negative bacillus from the respiratory passages of animals suffering from "distemper" and brings forward evidence to show that this organism is the cause of the disease (p. 459)].

2. **Infectious anæmia of horses.**—Carré and Vallée, by filtering through a special bougie rather more porous than Berkefeld V a mixture of one part of serum from a horse suffering from this disease and four parts of normal saline solution, obtained a virulent filtrate. When this filtrate is inoculated into the jugular vein of an horse in doses of 500 c.c. it produces, after an incubation period of 6 days, an anæmia which runs a characteristic course and which can be transmitted from one animal to another. The virus will also pass through a Berkefeld V or Chamberland F or B but the incubation period under these circumstances is of longer duration.

3. **Bird diphtheria.**—Ætiologically bird diphtheria is a totally different disease from human diphtheria. Guérin thought it was due to a coccobacillus belonging to the Pasteurella group which he found in the heart blood of infected birds: this organism on inoculation however gave rise to a fatal septicæmia quite different from the naturally acquired disease.

By grinding up in normal saline solution the nictitating membrane of a fowl which had been infected with a thread dipped in an emulsion of a false membrane, Bordet obtained an emulsion which produced in fowls the typical false membranes of bird diphtheria. When this emulsion was sown on blood agar, the only visible growth consisted of a few colonies of adventitious organisms: but by scraping the agar where there was no visible growth with a platinum wire, and transferring the scrapings to a little drop of water and rubbing the mucous membrane of the mouth with the emulsion, false membranes were produced in a normal fowl. Serial cultures can also be obtained and occasionally extremely small colonies are visible. Under the microscope an emulsion of the cultures shows very large numbers of small granular dots generally collected together in masses. This organism and that of pleuro-pneumonia seem to be the smallest yet cultivated.

According to Carnwath, this filtrable virus appears to be identical with that of *molluscum contagiosum* of birds (*vide ante*). In an epizootic of diphtheria among birds investigated by him the virus produced indifferently *molluscum contagiosum* or diphtheria according as to whether the material was inoculated on the bucco-pharyngeal mucous membrane or on the comb.

[G. Dean and Marshall have recorded an outbreak of diphtheria in the wood pigeon apparently due to a filtrable virus. By painting a filtered (Berkefeld filter) emulsion of a membrane from an infected bird on to the throat of doves they were able to reproduce the disease experimentally.]

SECTION XI.—THE VIRUS OF SWINE FEVER OR HOG-CHOLERA.

The rôle which a filter-passing virus is believed to play, according to recent research, in the ætiology of hog cholera has already been adverted to when discussing the bacillus known as *Bacillus aertrycke* (p. 438). [The conclusion is that Hog-cholera or swine fever is due to a filtrable virus present in the blood of the sick animals and that the hog cholera bacillus (*bacillus cholerae suis* of Salmon and Theobald Smith) is a secondary infection, which is commonly present, and which may increase the mortality among infected animals.

[These facts established first by Dorset and M'Bryde in America have been fully confirmed by M'Fadyean and Stockman in England, by Uhlenhuth in Germany and by many other observers in countries where swine fever is prevalent.

[The virus of swine fever will pass through a Chamberland F porcelain bougie: if the blood of a sick animal be diluted ten times it will, after filtration through this bougie, on inoculation in suitable dose into a young pig (10–20 c.c.) give rise to a typical attack of swine fever; and healthy pigs kept in contact with an infected animal will contract the disease (Stockman).

[Pigs are the only susceptible animals and after recovery from the disease are immune to further infection. This natural immunity after a natural attack of the disease is an important fact in establishing that the filtrable virus and not the hog cholera bacillus is the cause of the disease. Animals immunized against this bacillus are not immune to swine fever.

[The virus is present in the blood and in all the internal organs of animals suffering from swine fever. It is also found in the urine, secretions from the eyes and nose and in the pustular eruption on the skin (Uhlenhuth). The excreta do not appear to be infective—or to be more precise, are not an important source of infection. Some animals appear to retain the virus for some time after the acute symptoms have subsided.

[Healthy animals can be infected through the mouth, skin or the mucous membranes. The disease can also be transmitted by inhalation.

[The virus is highly resistant to external influences. It can be preserved in animal tissues or fluids for many months either at room temperature or in the ice chest. Desiccation appears to have no effect upon the virulence of infected material, nor does heating at 58° C. for 2 hours: but heating at 72° C. for 1 hour destroys the virus. The virus is more resistant to the action of antiformin than the hog-cholera bacillus.

[Certain cell inclusions are found in smear preparations from the conjunctivæ of almost every animal suffering from swine fever. These are similar to the cell inclusions (Chlamydozoa) described by Prowazek and Halberstadter in trachoma which they were inclined to regard as the cause of this disease. No evidence has yet been adduced in favour of the parasitic nature of these cell inclusions (cf. Negri bodies in Rabies).

Artificial immunization.—[Starting from the well established fact that pigs which have recovered from swine fever are immune to the disease attempts have been made to induce an artificial immunity by inoculating susceptible animals with the serum of hyper-immunized animals.

[Pigs which have recovered from an attack of the naturally-acquired disease are hyper-immunized by inoculating them sub-cutaneously, intravenously or intra-abdominally with the filtered serum or defibrinated blood of infected animals.

[The serum is prophylactic rather than curative, and therefore if it is to be utilized to the greatest advantage in an outbreak it should be used at the earliest possible moment after the appearance of the disease. A dose of about 20 c.c. should be inoculated sub-cutaneously as a prophylactic measure.

[In America and on the Continent the results appear to be most satisfactory. When used at an early stage of an outbreak 2·9 per cent. of the treated animals died against 93 per cent. of the untreated (Uhlenhuth) : in herds where hog-cholera existed 13 per cent. of the treated died against 75 per cent. of the untreated : in herds which had been exposed to disease 4 per cent. of the treated died against 89 per cent. of the untreated (Dorset).]

SECTION XII.—THE VIRUS OF ACUTE ANTERIOR POLIOMYELITIS.¹

Syn.—*Infantile paralysis. Fr. La poliomyélite épidémique: Maladie de Heine-Mélin.*

Landsteiner and Popper in 1908 were the first to show that acute anterior poliomyelitis could be reproduced in monkeys by inoculating into the peritoneal cavity an emulsion of the spinal cord of an affected individual. Levaditi and Landsteiner further demonstrated that the effect produced in the monkey was not simply the result of the inoculation of a toxin but was a true infection. These observations were soon confirmed by Flexner and Lewis in New York, Leiner and Wiesner in Vienna and subsequently by many other observers.

The virus of acute anterior poliomyelitis belongs to the group of filtrable viruses : if pieces of the spinal cord of a child who has died of the disease be emulsified in normal saline solution and the emulsion be filtered through a Chamberland, Berkefeld or Reichel filter (*in vacuo* under a pressure of 30–40 cm.) the filtrate inoculated into susceptible animals will be followed by the symptoms and lesions of the disease ; moreover the virus can be passed from animal to animal, a fact which proves that it is a living proliferating organism.

The organism has never been seen neither have attempts to cultivate it succeeded : if a virulent filtrate be sown on culture media the cultures remain sterile, and if a drop of the filtrate be examined microscopically no organism can be seen in it.

The virus can be preserved unaltered in the ice-chest in a glycerin-saline solution (1 to 2) for considerable periods of time (5 months, Roemer and Joseph) and in this respect resembles the viruses of rabies and *variola vaccinia*. Emulsions of virulent cords will retain their infectivity for at least a fortnight when dried *in vacuo* over sulphuric acid (Levaditi and Landsteiner). Similarly portions of the spinal cord placed in bottles over potash and kept in the dark are found to be infective after the lapse of 24 days.

The organism of acute anterior poliomyelitis is localized chiefly in the spinal cord, medulla oblongata and intervertebral ganglia but has been found in the cervical cortex (Flexner and Lewis) and in the olfactory bulbs (Levaditi and Landsteiner, Flexner). It does not under ordinary circumstances remain long in the cerebro-spinal fluid or in the blood-stream.

Experimental infection.

Apes and monkeys are practically the only animals susceptible to infection with the virus of acute anterior poliomyelitis ; most laboratory animals appear to be immune, though in some cases atypical symptoms and lesions have been produced in rabbits.

Methods of infection.—Monkeys can be experimentally infected by almost any method of inoculation : intra-peritoneal, intra-cerebral, intra-ocular, intra-venous, by the nasal mucous membrane, etc. The disease can also be set up in these animals by feeding them upon infected material (Leiner and Wiesner). It is to be noted however that in Levaditi and Landsteiner's experience the disease cannot be produced by rubbing the virus into the scarified surface of the skin and that sub-cutaneous inoculation cannot be

¹ This section has been added.

relied upon to infect the animal. Infection follows if the virus be inoculated into the sheath of a nerve trunk: this is of interest in that it shows that the virus travels up the nerves, probably along the lymphatics.

Further, after inoculation of the virus into a nerve trunk the characteristic paralyses always appear first in the limb supplied by that nerve (Flexner and Lewis, Levaditi and Landsteiner, Leiner and Wiesner).

With regard to infection by the respiratory passages: In their earlier experiments Levaditi and Landsteiner failed to infect monkeys either by painting the mucous membranes of the nose and back of the throat with an emulsion of the virus or by plugging the nasal fossæ with wool soaked in the virus, but succeeded when they inoculated the infected material beneath the nasal mucous membrane. Flexner and Lewis also infected animals by painting the virus on the scarified surface of the nasal and pharyngeal mucous membranes.

Leiner and Wiesner, on the other hand, were able to infect monkeys by painting the nasal mucous membrane without previous scarification, by inhalation and by injecting the virus into the trachea and though Levaditi and Landsteiner suggested as a possible explanation of these results that the monkeys used by Leiner and Wiesner may have had at the time of the experiment some small abrasions on the mucous membranes which escaped their observation, it is now established that the virus passes with readiness and constancy from the intact, or practically intact, mucous membrane of the nose to the central nervous system (Flexner).

Experimental monkeys have never been observed to contract the disease by contagion (Flexner and Lewis, Levaditi and Landsteiner, Leiner and Wiesner, Roemer).

Symptoms generally appear after an incubation period of about 8 days (7-11 days). The period of incubation is rather longer when a filtered virus is used than when an unfiltered emulsion is inoculated and also when a relatively small dose is inoculated.

Symptoms.—After the period of incubation has elapsed certain prodromal symptoms of which the most constant are twitchings all over the body mark the onset of the disease. These initial symptoms are followed, as a rule within a few hours, first by paralysis of the hind limbs, then of the posterior part of the body, trunk, arms and neck: the bulbar centres are subsequently affected, and death takes place in 2-3 days. This is the most usual course for the disease to run and is known as the *Ascending type*. It resembles Landry's ascending paralysis often observed during epidemics of acute anterior poliomyelitis.

In another type known as the *superior type* the neck muscles are mainly involved and to some extent the muscles of the fore limbs.

The experimental disease is occasionally manifested by paralysis of the motor cranial nerves, generally the VIIth or the IIIrd.

In addition to these types various "mixed" paralyses may be produced.

In milder infections the acute symptoms are followed by paralysis, muscular atrophy and deformity: occasionally the animals recover completely. In a few cases relapses occur and a different part of the body from that attacked in the first instance may be involved.

Immunity.—One attack of the disease even if atypical and abortive almost always confers a complete and lasting immunity.

The serum of persons and of experimental animals which have recovered from the disease is microbicidal *in vitro* (Levaditi and Landsteiner, Flexner and Lewis).

Prophylactic vaccination.—Levaditi and Landsteiner by applying Pasteur's method of vaccination against rabies have successfully vaccinated monkeys against acute anterior poliomyelitis. Infected spinal cords are dried in bottles over caustic potash for varying periods of time (3-9 days) and inoculations of emulsions of the dried cords are made at short intervals.¹

The method is however hardly safe for practical purposes because a cord dried for 24 days over caustic potash still contains the living virus (*vide supra*).

Flexner and Lewis have immunized monkeys by inoculating them subcutaneously with diluted emulsions of the virus gradually increasing the amount of virus inoculated.

Though immune serums have been proved to be microbicidal *in vitro* they have no effect on the course of the disease when inoculated intra-peritoneally or intra-spinaly.

Ætiology.—Flexner is of opinion that in man the nasal mucous membrane is the site both of ingress and egress of the virus of poliomyelitis and from experiments devised to determine the channel of infection "the conclusion is unavoidable that the virus ascends by the nerves of smell to the brain, multiplies in and about the olfactory lobes and in time passes into the cerebro-spinal liquid which carries it to all parts of the nervous organs" (Flexner). The distribution of the virus as spray in coughing and speaking is readily accomplished and by this means both active cases and passive carriers may be produced.

With regard to other conceivable modes of propagation it is of interest to note that Rosenau, whose observations have been confirmed by Anderson and Frost, has succeeded in conveying poliomyelitis from an infected monkey to other monkeys by means of the bites of flies (*Stomoxys calcitrans*) but as Flexner points out the experiment awaits convincing application to the circumstances surrounding infection in human cases of the disease.

Seeing that paralysis is not uncommonly observed in dogs, hens and certain other animals, it has been thought possible that some of the lower animals may act as a reservoir of the infection. So far as experimental evidence has been obtained it rather negatives the hypothesis of a relationship between poliomyelitis in man and paralysis in the lower animals. These experiments "do not, of course, exclude the possibility that a reservoir for the virus may exist among domesticated animals that do not even respond to its presence by developing paralysis or other conditions which could be recognized as resembling poliomyelitis in man" (Flexner).

Diagnosis of anterior poliomyelitis.—In mild or atypical cases of the disease which have recovered but in which the diagnosis remains uncertain information as to the true nature of the disease can be obtained by mixing some serum from the patient with the virus *in vitro* and inoculating an animal: a control animal being inoculated with the same dose of the virus unmixed with serum.

Acute anterior poliomyelitis and rabies.—In many respects the viruses of these two diseases bear a close resemblance to one another. Thus they both travel along the nerve trunks, both exhibit a selective affinity for the central nervous system, both pass through porcelain or similar filters and both react to chemical and physical influences in a similar manner. These resemblances led Levaditi and Landsteiner to investigate whether an attack of one disease would immunize an animal against the other and were able to show that monkeys highly immunized against anterior poliomyelitis were quite as susceptible to rabies as control animals.

¹ Levaditi and Landsteiner, *Ann. Inst. Pasteur*, xxiv. p. 866.

SECTION XIII.¹—THE VIRUS OF TYPHUS FEVER.²

The micro-organism which causes typhus fever in man should be classified, according to Ch. Nicolle, Conor and Conseil, with the filtrable viruses.

The infecting agent is probably an intra-cellular parasite of the white cells of the blood. By animal experiment it has been shown that the blood is infective from an early stage of the incubation period until convalescence is well established. To obtain successful results with filtered blood the latter should be allowed to clot spontaneously and the serum should be filtered through the most porous type of Berkefeld bougie.

The results obtained by Nicolle and his co-workers are not in accordance with the observations of Anderson and Goldberger and of Ricketts and Wilder in America. But as Nicolle points out the American bacteriologists used for inoculation a product obtained by filtering the serum after defibrinating and then centrifuging the blood and Nicolle and his colleagues, Conor and Conseil, have themselves found that this product on inoculation into animals susceptible to infection with the virus of typhus fever is followed neither by infection of, nor by the appearance of immunity in, these animals. And not only so but they find further that the serum obtained from blood which has been allowed to clot spontaneously though generally non-infective after filtration is not invariably so. In the opinion of Nicolle, Conor and Conseil the only hypothesis which will explain their experimental observations is that under ordinary conditions the amount of the virus which passes the filter is generally too small to produce infection or immunity in experimental animals.

From the observations of Ricketts and Wilder it would appear that Mexican fever (*El Tabardillo*) and typhus fever are due to one and the same micro-organism.

Experimental infection. Apes and monkeys.—The chimpanzee and some of the lower monkeys (*Macacus sinicus*, *M. rhesus*, *M. cynomolgus*, and *M. inuus*) are susceptible to infection on inoculation with blood from human cases of typhus fever. Chimpanzees are highly susceptible but the lower monkeys less so; moreover it would appear that some individuals of a species e.g. *M. rhesus* are susceptible while others are insusceptible.

In the case of the lower monkeys in order to ensure infection in susceptible animals not less than 4–5 c.c. of blood should be inoculated and it is better to inoculate intra-peritoneally than sub-cutaneously.

The incubation period varies both with the species of monkey inoculated and also with the amount of blood used for the experiment. In the chimpanzee the incubation period is about 24 days but in the lower monkeys it is apparently shorter (13–22 days). Following the incubation period the temperature rises (40° C. or higher) for 8–10 days and then falls fairly rapidly to normal. During the febrile stage an eruption generally appears on the face but an injection of the conjunctivæ may take the place of a rash. The animal is obviously unwell for the time being but about a week after the fever has disappeared it is restored apparently completely to its normal health.

Guinea-pigs.—Guinea-pigs can also be infected with the virus of human typhus fever.

The blood (2–3 c.c.) should be inoculated into the peritoneal cavity. The incubation period varies from 1–3 weeks and the fever (40°–41° C.) lasts from 4–9 days. The blood is infective for monkeys during the whole of the febrile period.

In some cases the inoculated guinea-pig may exhibit no rise of temperature but the blood is nevertheless infective.

Gaviño and Girard have been able to pass the virus through a consecutive series

¹This section has been added.

²Gr. τῦφος smoke, mist, fog. The word was employed by Hippocrates to define a confused state of the intellect with a tendency to stupor; and in this sense it is aptly applied to typhus fever with its slow cerebration and drowsy stupor (A. W. Moore).

of eleven guinea-pigs and have shown that the blood of these animals is infective for monkeys.

Cows, sheep, goats, pigs, asses, dogs, rabbits, rats and fowl appear to be naturally immune to the virus of typhus fever.

Ætiology.—Nicolle, Comte and Conseil were able to transmit the virus of typhus fever from an infected *Macacus sinicus* to two other bonnet monkeys by means of body lice (*Pediculus vestimenti*). This observation has been confirmed by Ricketts and Wilder in America. According to Goldberger and Anderson the virus can also be transmitted by *Pediculus capitis*.

To ensure infection by means of lice a considerable number of insects should be employed. Ricketts and Wilder have adduced evidence which goes to show that the virus of typhus fever multiplies in the bodies of lice and that the infection may possibly be transmitted to a second generation of the insects—a fact of considerable interest and importance. It would appear that lice are capable of infecting a new host a week after being fed upon an infected individual.

PART VII.

**THE APPLICATION OF BACTERIOLOGICAL METHODS
TO THE EXAMINATION OF WATER AND AIR.**

CHAPTER LXV.

THE BACTERIOLOGICAL EXAMINATION OF WATER.

Introduction.

Section I.—The collection and transmission of samples of water, p. 851.

Section II.—The methods of examination, p. 853.

1. Enumeration of the organism, p. 853.
2. Determination of the nature of the organisms present, p. 856.
3. Houston's method of water examination, p. 858.

The bacteriological examination of sewage, p. 861.

A CHEMICAL analysis of water by showing the presence of organic matter, nitrites, chlorides, ammonia, etc., will merely give a general indication that a water is polluted. A bacteriological examination on the other hand will not only reveal the fact that impurities are present in a water but will enable the living organisms which it may contain to be enumerated, isolated and identified. The detection of pathogenic micro-organisms in water is frequently of the highest importance.

The bacteriological examination of water may therefore be divided into three parts :

1. *The enumeration of the organisms present.*—Quantitative examination.
 2. *The determination of the chief species present.*
 3. *The isolation and identification of certain pathogenic organisms.*
- } Qualitative examination.

With a view to avoiding the introduction of organisms from without certain precautions are necessary in collecting a water for bacteriological examination, and moreover the sample must be transmitted to the laboratory under such conditions as to prevent multiplication of the organisms in the water before the examination is begun, otherwise the results of the enumeration will be falsified.

SECTION I.—COLLECTION AND TRANSMISSION OF SAMPLES OF WATER.

Collection.—The water must be collected in a sterile vessel. In the majority of cases 200–300 c.c. will be sufficient but in certain cases, as for instance in searching for some of the pathogenic organisms, it is well to have 400–500 c.c. The method of collection will be as follows :—

1. Take a new white-glass bottle of suitable capacity, rinse it out well with water and after drying it plug it with wool and sterilize it.
2. To collect the water for examination flame the mouth of the bottle, remove the wool plug, fill the bottle as quickly as possible and plug with a

new tightly-fitting cork which has been passed through the flame of a spirit lamp until slightly carbonized. Cut off the cork level with the mouth of the bottle and seal with wax or—and this is perhaps better—cover it with a sterile india-rubber cap. Paste a label on the bottle giving the source of the sample and other particulars.

The method of filling the bottle will depend upon whether the water is to be taken from a tap, a river, a well, etc. Before taking a sample from a tap the water should be allowed to run to waste for several minutes in order to empty the pipe of any water that may have been standing in it. For a similar reason, in the case of pump water, the water should be pumped to waste for 10–15 minutes before taking the sample.

In collecting water from a river the bottle should be submerged with the neck pointing up stream: the sample should not be taken from too near the bank and the stirring up of sediment near the place selected should be carefully avoided.

When a well is not provided with a pump the bottle may be lowered with string, or filled from a bucket which must be previously well cleansed and then rinsed with the well water. It is however better in such a case to use a Miquel's flask with which water can be collected either from the surface or from any desired depth below the surface.



FIG. 407.—
Miquel's apparatus for the collection of water at different depths.

Miquel's flask (fig. 407).—Miquel's flask is a vessel of special shape the neck of which is drawn out to a length of 5–6 cm. and bent upon itself. Leave the pointed end unsealed and sterilize the flask by heating it strongly in a flame: during the heating the greater part of the contained air will be driven out and while still hot seal the open end. When cold the flask is weighted with lead fixed to it by means of iron wire and can thus be immersed. A long cord is attached to the apparatus to allow of its being lowered into a well; and a thin metal wire twisted round and fixed to the narrow pointed end of the flask, long enough for the operator to have one end always in his hand, serves to break the neck.

To take the sample hold the cord and the metal wire in one hand, lower the flask into the well, and when the apparatus has reached the required depth break the neck of the flask by giving a sharp pull on the iron wire. The flask rapidly fills with water and as soon as it is filled raise it and seal the open end in a spirit flame.

Other apparatus.—Miquel's apparatus will usually be found adequate but there are many other pieces of apparatus designed for the same purpose and from among these Guillemin's and de Foa's, which are constructed in such a way as to ensure the automatic closing of the flask as soon as it is filled, may be mentioned.

Transmission.—Organisms will rapidly multiply in water at the ordinary temperature of the atmosphere so that it is necessary in the case of water intended for bacteriological examination that the sample should be kept at a temperature of about 0° C.—a temperature which will inhibit multiplication—from the moment of collection until the examination is commenced.

When the water has to be sent some distance the following method of packing may be adopted.

Place the bottle containing the water in a metal box just large enough to hold it tightly, and for greater safety the lid may be secured with an india-rubber band over the joint. Place this box in another larger metal box—a biscuit box does very well—and fill the latter with ice; then place the second metal box in a larger wooden box, filling the space between the two with sawdust rather loosely packed. This arrangement will keep the sample of water at the temperature of melting ice for 24–72 hours depending upon the time of year and the amount of ice used. The water should invariably be sent to the laboratory by the most rapid means of transit.

The second metal box may be dispensed with and in this case the metal case into which

the bottle fits tightly is packed round with ice and sawdust—a large quantity of the latter will of course be necessary to absorb the water from the ice as it melts.

[Houston has devised a very convenient piece of apparatus for the collection and transit of water for bacteriological examination.

[It consists of a rectangular wooden box with an hinged lid the whole lined with thick felt. The box contains an hollow water-tight copper vessel—which fits two sides of the wooden box closely—destined for the reception of ice and closed above with a large india-rubber bung. The remainder of the space is occupied by a felt box open above and divided into compartments for the reception of flat rectangular bottles. The wooden box with its felt lining acts as a non-conductor of heat and the copper vessel with its contained ice keeps the temperature at as near 0° C. as possible. The bottles used are ground-glass-stoppered bottles of 8 ozs. capacity. The stopper should be covered with paper before sterilization and this should not be removed until the water is to be collected.]

Particulars to accompany the sample.—Full particulars as to the source of the water, the nature of the examination required, etc. should accompany the sample so that as much information as possible may be furnished upon which to base an opinion.

The following is a copy of the official form in use in the French military sanitary service :—

Particulars of the water sent for examination by—

(1) Authority by whom sent—

(2) Reasons for sending (epidemic,—spring to be tapped—potable water,—etc.).

(3) Source of the water (spring, well, filtering gallery, cistern, reservoir, etc.). State the depth of the well, cistern, or reservoir and the level of the water at the time of collection.

(4) Exact place where the water was collected (e.g. whether from the spring itself or from a tap at the end of a conduit—whether from a well or from a pump connected with the well): never collect the water which first issues from a tap or a pump. If the water is taken from a river, well or reservoir, state whether collected from the surface, or from the bottom or from some intermediate point. State the last occasion on which the cistern or reservoir was cleaned and whether there is dust on the surface or sediment at the bottom.

(5) Has any rain fallen or snow melted in the few days preceding the taking of the sample? Is the water muddy? Is the level above or below normal?

(6) State any cause of permanent or accidental pollution to which the water appears to be exposed.

(7) The purposes for which the water is required (i.e. for drinking purposes, cooking, lavatories, watering horses, etc.).

(8) Is the water used for drinking without previous purification? State, if there is any, the apparatus used for purification.

(9) Atmospheric temperature at the time of collection.

(10) The temperature of the water at the same time.

(11) Day and hour of collection.

(12) Other remarks.

SECTION II.—METHODS OF EXAMINATION.

1. Enumeration of the organisms.

Numerous methods of enumerating the organisms in water have been suggested. Some bacteriologists base their methods upon isolation by dilution in liquid media (p. 76) (Miquel). Others adopt the method of isolation on gelatin plates (Koch).

It is not proposed to discuss the pros and cons of these different procedures but those in most general use will now be described in detail.

General rules.—The cubic centimetre is generally adopted as the unit of volume in enumerating the number of organisms in water and it is customary to speak of a water as containing say 50,000 organisms per c.c.

No account is taken of the presence of anaërobic organisms in stating the number present in a water: the determination is always made under aërobic conditions and this is always tacitly understood. By employing anaërobic methods of isolation the number of anaërobic organisms could of course be determined, but in practice this is never done, and it presents difficulties other than those of technique—such for instance as the occurrence of facultative anaërobes, many of which, as a matter of fact, grow on the aërobic plates.

Vincent investigated the occurrence of anaërobic organisms in water and found that the number of strictly anaërobic organisms was very small. He used Vignal's tubes and glucose-gelatin, containing sulphindigotate of sodium (p. 92). The medium was sown by the dilution method, and for the detection of pathogenic species the colonies so isolated were sub-cultivated anaërobically in broth and then inoculated into animals (p. 858).

In determining the number of organisms in an unit volume of water it is usual to work with a fraction of a cubic centimetre because the number of organisms present in a cubic centimetre is generally so large as to make an enumeration impossible.

A. Dilution method.—1. Chip away the wax with which the cork was sealed and flame the top of the cork in a Bunsen: raise the cork with a flamed corkscrew sufficiently to allow of it being removed from the bottle with the fingers.¹

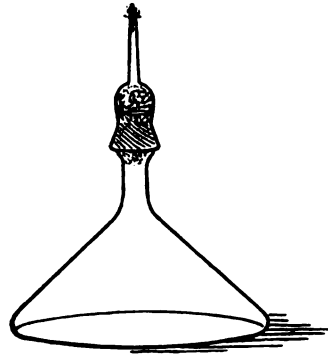

FIG. 408.—Conical flask (Gayon's) for water examination.

2. Have ready on the bench:—

A 10 c.c. pipette graduated in 1 c.c.

A 2 c.c. pipette graduated in 0.5 c.c.

A drop pipette (20 drops to 1 c.c.).

(All of which must, of course, have been plugged with wool at the upper end and sterilized.)

A sterile glass vessel covered with paper.

A tube of sterile water.

Several tubes of sterile gelatin in a water bath at a temperature high enough to keep the medium fluid.

Several conical flasks plugged with wool and sterilized (fig. 408).

3. Into the sterile glass vessel measure 9 c.c. of sterile water adopting all precautions to avoid contamination: add 1 c.c. of the water under examination and mix thoroughly. This gives a dilution of 1 in 10.

4. Flame the mouth of one of the conical flasks, remove the wool plug and with the drop pipette introduce 2 drops of the 1-10 dilution of the water (= 0.01 c.c.).

5. Flame the mouth of one of the tubes of liquefied gelatin (the temperature of which should be such that the tube can be held quite comfortably in the hand), remove the plug and pour the contents quickly into the conical flask (par. 4). Replace the wool plug in the mouth of the flask, mix the gelatin and water thoroughly by rotating the flask and then stand the latter on some cold and horizontal surface so that the gelatin may set as quickly as possible.

In effect, plate 0.01 c.c. of the water on gelatin.

[6. Incubate at 20°-22° C.]

7. Colonies will soon appear in the gelatin, each colony representing one

¹ Before uncorking the bottle shake it well to mix thoroughly the contents and to distribute any deposit there may be uniformly throughout the whole.

organism originally present in the water: by counting the colonies the number of organisms present in the volume of water sown can thus be determined. The flask must be examined daily; the best way is to invert it; the colonies are then visible in the transparent medium through the bottom of the flask, and can be readily counted.

Thus, if on the third day, twelve colonies are visible a note should be made.

| | | |
|----------|-----------|--------------|
| 3rd day. | 5 August. | 12 colonies. |
|----------|-----------|--------------|

To avoid counting the same colonies twice, mark their position with a pen and ink on the base of the flask as they are counted.

If next day in addition to the twelve colonies marked eight more have appeared the note will read

| | | |
|----------|-----------|-------------|
| 3rd day. | 5 August. | 12 colonies |
| 4th day. | 6 August. | 20 colonies |

and so on.

The enumeration is ordinarily completed by the fifteenth to the twentieth day, after which no new colonies are likely to appear. Suppose then that the result is

| | | |
|-----------|------------|-------------|
| 20th day. | 22 August. | 64 colonies |
|-----------|------------|-------------|

the number of aerobic organisms in a cubic centimetre of the water will be ascertained by multiplying 64 by 100. The water therefore is said to contain 6400 organisms per c.c.

It is as well to sow several flasks with every sample of water, which may be numbered 1, 2, 3 and so on; the mean of the various results will be nearer the truth than the result of a single determination is likely to be: and if as often happens the number of organisms in the flasks varies but little, the accuracy of the technique is demonstrated and the results are of greater value.

In the case illustrated it is assumed that no liquefaction of the gelatin has occurred to interfere with the enumeration. Unfortunately, however, this is not the usual experience in practice; it is much more common to find that the water contains a high percentage of "liquefying" organisms so that after the first few days further enumeration is rendered difficult and finally impossible. In such cases the count should be continued until the plate is entirely liquefied and then the date of liquefaction noted. Thus, for instance,

| | | | | | | | | | | |
|----------|---|---|---|---|---|---|---|---|---|--------------------------|
| 2nd day, | - | - | - | - | - | - | - | - | - | 26 colonies |
| 3rd " | " | " | " | " | " | " | " | " | " | 59 " |
| 4th " | " | " | " | " | " | " | " | " | " | 102 " |
| 5th " | " | " | " | " | " | " | " | " | " | Plate entirely liquefied |

the results of the analysis should be recorded thus

10,200 (102 × 100) aerobic organisms per cubic centimetre. This number is much below the real total, liquefaction of the gelatin having terminated the count on the fifth day.

The statement of the result must be qualified in this way whenever liquefaction occurs before about the tenth day.

Note.—Many waters contain moulds as well as bacteria. The moulds develop on the plates and must be separately enumerated. Thus, for instance, a sample of water might contain

1256 aerobic bacteria and 300 moulds per cubic centimetre.

B. Method of enumeration using a $\frac{1}{50}$ c.c. pipette.—The dilution method is not only rather tedious but in inexpert hands affords opportunities of contamination. The method now about to be described is therefore often preferred.

The pipettes made by Alvergniat should be used: they are very carefully calibrated and give about 50 drops to the cubic centimetre. Pipettes giving

exactly 50 drops to the cubic centimetre cannot always be obtained on account of the difficulties in their manufacture but the actual number—48, 52, 54 drops or whatever the number may be—is always marked on the stem.

Sterilize a pipette (which it will be assumed gives 52 drops to the cubic centimetre). Aspirate a little of the water under examination and introduce one drop into a conical flask : add the gelatin and proceed with the enumeration as above (from par. 5).

Then by multiplying the number of colonies which have developed in the flask by 52 the number of organisms per cubic centimetre can be ascertained. If, for instance 96 colonies were counted

$$96 \times 52 = 4992 \text{ aërobic organisms per c.c.}$$

Two or three flasks should always be sown and the average of the results recorded.

Interpretation of the results of enumeration.

The *quantitative examination* is not alone sufficient to allow an opinion to be given on the purity of a water ; before drawing any conclusion a *qualitative examination*—a determination of the nature of the organisms present—must be undertaken. It is at once apparent, for instance, that a water containing a large number of harmless saprophytes (*B. subtilis*, the white coccus of water, etc.) would be infinitely preferable to another which contained a few pathogenic organisms such as the typhoid bacillus. Still, from the point of view of ordinary pollution the total number of organisms is of some importance. Miquel has classified waters according to their content of organisms ; this classification is convenient but it should not be utilized until the results of the qualitative examination are known and have been taken into consideration.

MIQUEL'S TABLE.

| | | | |
|-------------------|---------------------------------|---|-----------------------|
| 0 to 10 | organisms per cubic centimetre, | - | Extraordinarily pure. |
| 10 | „ 100 | „ | - Very pure. |
| 100 | „ 1,000 | „ | - Pure. |
| 1,000 | „ 10,000 | „ | - Moderate. |
| 10,000 | „ 100,000 | „ | - Impure. |
| More than 100,000 | „ | „ | - Very impure. |

Note.—Any such classification as this is, of course, very arbitrary and of limited value for the reasons given. It may be remarked here that most methods of enumeration are liable to underestimate the numbers of organisms contained in a given volume of water. For instance, there may be organisms present in the water which fail to grow on the culture medium on account of the presence of other species acting on them prejudicially as “inhibiting organisms.” Moreover, pathogenic species of organisms will hardly grow on gelatin plates, not only because they are held in check by saprophytes, but also because the temperature of incubation is unsuited to their multiplication. It will be obvious that Miquel's dilution method in which an attempt is made to sow each organism in a different tube is free from these sources of error, but unfortunately by reason of its complexity it is of little practical value.

QUALITATIVE EXAMINATION.

2. Determination of the nature of the organisms present.

A. The isolation of saprophytic species.

It is usual for the identification of the various species of micro-organisms which may be present in a water to isolate the organisms on Petri dishes (p. 78). Sow one drop of the water in a tube of melted gelatin, mix, sow two or three loopsful of the mixture into a second tube of gelatin, mix again, and sow two or three loopsful from the second tube into a third tube and pour plates with the mixtures. The growths on the plates are carefully

watched and sub-cultures sown when necessary for the identification of a particular colony.

In the case of beginners the identification of the various micro-organic species involves a very considerable amount of labour: each colony must be separately examined with the naked eye and under the microscope, the morphology of the organism must be studied and its cultural characteristics investigated together with its effect on animals. A little practice however soon confers sufficient knowledge to enable the greater number of the colonies to be recognized quite easily.

It is not within the province of this book to enter upon a detailed description of the saprophytic micro-organisms likely to be encountered in water, but it may be said that while some of them are absolutely harmless others (e.g. *Proteus vulgaris*, *Micrococcus prodigiosus*) elaborate soluble products which may give rise to symptoms of toxæmia in man and the lower animals. These species tend to inhabit decomposing animal matter so that their isolation from a water to be used for domestic purposes would be an unfavourable indication. The odour again which is given off from the gelatin plates should be noted for it is not unusual to find that bacteria associated with putrefactive processes give rise to disagreeable ammoniacal emanations.

B. The detection of pathogenic species.

As has been said above the gelatin-plate method is not, speaking generally, an efficient method for the detection of pathogenic species, and for the isolation of such organisms the author has adopted for several years now with considerable success the following technique which he recommends should form an integral part of every water examination.

Sow 0.5–2 c.c. of the water in tubes of broth or better Metchnikoff's liquid peptone-gelatin medium and incubate the tubes forthwith at 38° C. In some cases no growth whatever will be visible after 24 hours: the experiment need not then be pursued further, and the results may be regarded as negative. Much more frequently however a cloudiness will appear in the tubes after incubating for 5–8 hours. This rapidly-appearing turbidity is almost always due either to the colon bacillus or to other species of pathogenic organisms, since saprophytic bacteria grow more slowly at this temperature. When the cloudiness is well-marked within 6–10 hours of sowing transfer a loopful of fluid to a fresh tube of medium and after mixing sow a loopful into a second tube and incubate again. As soon as the second tube becomes cloudy plate a trace of the growth on agar by the parallel stroke method for the purpose of getting single colonies. Incubate the plates in a moist chamber at 37° C. which affords conditions particularly favourable to the rapid multiplication of pathogenic organisms. This method has enabled the author to isolate from different waters *Bacillus pyocyaneus*, the pneumobacillus of Friedländer, the colon bacillus and the various micro-organisms of suppurative.

The isolation of the colon bacillus or of closely related bacteria from a water is a matter of frequent occurrence and formerly so much importance was attached to the fact that any water in which it was found was condemned. At the present time however since with more perfected methods the colon bacillus can be isolated from a very large number of waters there is a tendency to go to the opposite extreme, to attach no importance whatever to its occurrence and to regard it as an harmless saprophyte. In the author's opinion the truth lies between these extremes, for though in some cases the presence of a few colon-like bacteria may be without significance, in other cases it may indicate direct pollution with matter of excretal origin. Further it must not be forgotten that this organism is found in a large

number of samples of typhoid-infected waters and it may altogether mask the presence of the typhoid bacillus.

Whenever a colon bacillus is isolated from a sample of water its characteristics should be carefully studied. If these agree in all details with those of the typical colon bacillus of Escherich (and the author attaches considerable importance to the rapidity with which milk is coagulated) and more particularly if the strain isolated prove to be pathogenic to guinea-pigs (using 0.5-1 c.c. of a 24-hour broth culture intra-peritoneally) no hesitation need be felt in expressing an adverse opinion upon the water. The coincident occurrence of bacteria associated with putrefaction renders it still more probable that the pollution is excretal in origin.

Great importance is to be attached to the inoculation of animals with organisms isolated from water and grown at 37° C. This experiment should never be omitted before coming to a final conclusion.

Vincent attaches some importance to the numbers in which the colon bacillus is found in a water and in his opinion a water which only contains 10 to 50 colon bacilli per litre may be regarded as good in quality. For the purpose of ascertaining the number present he adopts the dilution method using broth containing 0.70 per 1000 of carbolic acid.

[An opinion upon a water must be based upon a number of data of which the occurrence of the colon bacillus is merely one. The numbers in which the colon bacillus or colon-like bacteria are present is, of course, a matter of importance but its importance depends upon other factors: for these numbers will vary according to the source of the water, and a number which would be sufficient to condemn absolutely a deep well water would be disregarded in an upland surface water. In effect an absolute standard cannot be fixed: a mere laboratory examination of the water without a full knowledge of its source is in the vast majority of cases of little or of no value. The real value of a bacteriological examination will depend upon the consideration of all the facts both as to source, method of collection, mode of transit, and the nature and number of the various micro-organic species present; and the interpretation of these data is a matter requiring considerable knowledge and experience. Moreover it is now agreed by all who are in a position to express an opinion, that before a reliable conclusion as to the purity of a water can be arrived at the laboratory examination must be systematic extending over a period sufficient to cover all possible or likely sources of contamination.]

C. Systematic examination for certain pathogenic organisms.

During an epidemic of enteric fever or cholera or if a number of cases of anthrax occur, the specific organisms should be systematically sought for.

The pathogenic organisms which have most frequently to be isolated are the colon bacillus, the typhoid bacillus, the pneumobacillus, the anthrax bacillus and the cholera vibrio. The methods to be adopted in each of these cases have already been described in the chapters devoted to a detailed consideration of these organisms.

3. Houston's method of water examination.¹

Houston some years ago introduced a method for the bacteriological examination of water which in the United Kingdom and in many parts of the Dominions beyond the Seas has now superseded all others.

The sample of water is examined with a view to determining

1. The total number of organisms present.

¹ This sub-section has been added.

2. The presence of the colon bacillus and of colon-like bacteria and the approximate numbers of these organisms.
 3. The presence of the *Bacillus enteritidis sporogenes* and the numbers in which it occurs.
 4. The presence of streptococci.
1. The total number of organisms present is ascertained by methods similar to those described above (Section II. 1.) and both agar and gelatin plates may be sown to ascertain the numbers of organisms which will grow at 37° C. and 22° C. respectively.
2. The detection of the colon bacillus.—For this determination Houston uses MacConkey's bile-salt fluid (p. 412) as the preliminary enrichment medium and then MacConkey's agar medium for isolation from the preliminary medium.
3. The presence of the *Bacillus enteritidis sporogenes* is determined by sowing known volumes of the water in milk and cultivating anaerobically.
4. For the detection of streptococci measured quantities of the water are sown in broth and incubated at 37° C.

Experimental data.

1. Apparatus and media required.

(a) Pipettes graduated to measure (1) 100 c.c. (2) 10 c.c. (3) 1 c.c. (4) 0·1 c.c.

(β) Media.

- (1) Test tubes containing a measured 9 c.c. of sterile distilled water.
- (2) Tubes containing about 10 c.c. of sterile gelatin and others containing about 10 c.c. of sterile agar.
- (3) Tubes containing about 10 c.c. of MacConkey's lactose-bile-salt fluid¹ (p. 412).
- (4) Tubes containing a measured 10 c.c. of MacConkey's fluid of *double strength* :—

| | |
|---|-----------|
| Peptone, - - - - - | 40 grams. |
| Lactose, - - - - - | 10 " |
| Sodium taurocholate, - - - - - | 10 " |
| Chalk, ¹ - - - - - | 20 " |
| 10 per cent. litmus solution, - - - - - | 200 c.c. |
| Water, - - - - - | 1000 " |

- (5) Tubes containing a measured 50 c.c. of MacConkey's fluid of *triple strength* :—

| | |
|---|-----------|
| Peptone, - - - - - | 60 grams. |
| Lactose, - - - - - | 20 " |
| Sodium taurocholate, - - - - - | 15 " |
| Chalk, - - - - - | 30 " |
| 10 per cent. litmus solution, - - - - - | 300 c.c. |
| Water, - - - - - | 1000 " |

- (6) Tubes containing about (i) 50 c.c. and (ii) 10 c.c. of sterilized milk from which the cream has not been removed.
- (7) Tubes containing about 10 c.c. of sterile broth.
- (8) Petri dishes.

2. Technique.

Remove the bottle containing the sample of water from its case and thoroughly mix the contents by shaking. Take out the stopper and flame the mouth of the bottle.

1. Sow 100 c.c. into 50 c.c. of MacConkey's triple strength fluid.

¹ Chalk is added in order that the acid and gas produced by lactose-fermenting organisms may be more readily recognized. Some observers prefer a small thin-walled glass tube (Durham's tube) which is inverted into the medium and serves to collect the gas.

860 THE BACTERIOLOGICAL EXAMINATION OF WATER

2. Sow 10 c.c. into 10 c.c. of MacConkey's double strength fluid and a second 10 c.c. into 50 c.c. of milk being careful that the water passes beneath the cream.

3. Sow 1 c.c. into a tube of MacConkey's medium (ordinary strength); a second 1 c.c. into 10 c.c. of milk; a third 1 c.c. into broth and a fourth into 9 c.c. of sterile water.

4. Thoroughly mix the last tube in which the water under examination has been added to sterile water. Sow 1 c.c. of this mixture—representing 0.1 c.c. of the water—into MacConkey's fluid, into gelatin and into agar (melted and cooled to 40° C.) and a further 1 c.c. into a second tube of sterile water (9 c.c.).

5. After mixing use 1 c.c. of the diluted water—equivalent to 0.01 c.c. of the water—for sowing MacConkey's medium, gelatin and agar as before; and if necessary proceed to further dilution.

6. Pour the agar and gelatin into Petri dishes. Incubate the cultures at 37° C. with the exception of the gelatin plates which must be grown at 22° C. The milk tubes must be heated first at 80° C. for 15 minutes and then be grown anaerobically in a Bulloch's apparatus (p. 96).

The plates must be examined daily and the colonies counted as described above. The other cultures are examined after 48 hours' incubation:—

i. The broth tubes for streptococci by examining the deposit microscopically.

ii. The milk tubes for the "enteritidis change"—considerable formation of gas, an odour of butyric acid, separation of the curd from the whey and tearing up of the curd by the gas evolved.

iii. The MacConkey's tubes for the presence of gas.

If gas is formed a loopful of the culture is diluted in sterile water and one or two loopfuls of the dilution used for sowing a surface culture of MacConkey's taurocholate-lactose-agar for the purpose of isolation. The agar is incubated at 37° C. and after 24 or 48 hours is examined for colon-like colonies. If such colonies be found one or more is sown in a tube or tubes of liquefied glucose-gelatin and the tubes incubated at 20° C. If gas be formed the gelatin is liquefied and the culture used for sowing the following media:—

1. Neutral-red broth.

| | | | | | |
|--------------------------------------|---|---|---|---|--------|
| 1 per cent. solution of neutral-red, | - | - | - | - | 2 c.c. |
| Broth, | - | - | - | - | 1000 " |

2. Peptone water.

3. Litmus milk.

These tubes are incubated at 37° C. and then examined respectively for

i. Fluorescence in the neutral-red-broth.

ii. Indol in peptone water (Ehrlich's test, p. 374 e).

iii. Acid and clot in milk.

If an organism which gives all the reactions described has been recovered from any of the MacConkey tubes the water is said to contain "typical colon bacilli"¹ in that amount. Thus if an organism having these characteristics be isolated from the 100 c.c. tube but not from the 10 c.c., 1 c.c. or 0.1 c.c. tubes the water is said to contain typical colon bacilli in 100 c.c. but not in less. Similarly a water from 1 c.c. of which a typical colon bacillus was isolated but not from 0.1 c.c. is said to contain at least 1 but not 10 colon bacilli per c.c.

¹ Such an organism is described by Houston as a "Flaginac" colon bacillus:—*Fl*, fluorescence in neutral-red-broth; *ag*, acid and gas in a lactose medium; *in*, indol in peptone water; *ac*, acid and clot in milk.

THE BACTERIOLOGICAL EXAMINATION OF SEWAGE 861

To give some concrete notions with regard to the nature and number of organisms found in water some figures may be abstracted from Dr. Houston's reports. Taking the London Metropolitan water supply for the year ending March 31st 1909 :—

1. Total number of organisms (Gelatin plates at 20°–22° C. 3 days).—

| | River Thames. | River Lea. | New River. |
|---------------------------------------|---------------|------------|------------|
| Raw water (organisms per c.c.) - - | 2558 | 8794 | 1118 |
| Filtered water (organisms per c.c.) - | 11·3 | 18·9 | 6·1 |

2. "Typical" colon bacillus test.—

| | River Thames. | River Lea. | New River. | All London Waters. |
|---------------------|---------------|-------------|------------|--------------------|
| Raw waters - - | 15 per c.c. | 25 per c.c. | 1 per c.c. | — |
| Filtered waters - - | — | — | — | 2 per litre. |

The bacteriological examination of sewage.

[Houston's method of water examination is equally applicable to the investigation of the nature and number of organisms present in sewage. In this case, of course, the sewage must be diluted to a far greater extent than is necessary in the case of water and it will be necessary to examine 0·000,001, 0·000,000,1 and even 0·000,000,01 c.c. for the presence of colon bacilli.]

CHAPTER LXVI.

THE BACTERIOLOGICAL EXAMINATION OF AIR.

Introduction.

1. Original methods, p. 862.
2. Methods employed at the present day, p. 864.
 - A. Methods based upon filtration, p. 865.
 - B. Methods based upon bubbling the air through a suitable liquid, p. 866.

THE bacteriological examination of air may be either quantitative or qualitative, depending upon whether it is proposed to ascertain the number of organisms present in a given volume of air or whether the object is to determine to what species these organisms belong. Finally, the object of the experiment may be to detect the presence of some given pathogenic organism.

Since the number of organisms in air is small the unit adopted is a cubic metre: thus it is usual to say that the air of a room contains 500, 1000, or 3000 organisms per cubic metre as the case may be.

For a long time it was considered sufficient to examine microscopically the dust of the air collected by means of an *aëroscope*. The *aëroscope* most generally in use in France is that of Pouchet. It consists of a glass cylinder closed at both ends: inside, about the middle, an ordinary microscope slide is held by two supports and on the upper surface of the slide a drop of glycerin is placed. The top of the glass cylinder is perforated in the centre by a circular hole carrying a platinum funnel, the tube of which passes into the cylinder above the centre of the slide. A tubulure fixed to the lower part of the *aëroscope* is connected to an aspirator. When the aspirator is working, the air passing through the funnel impinges upon the slide and deposits its suspended dust which is retained there by the glycerin. When a sufficient volume of air has been drawn through, the aspirator is turned off, and the slide removed; the dust is distributed by means of a sterile needle through the glycerin which is then covered with a cover-glass and examined under the microscope. In this way the larger particles of dust in the air may be studied—spores of fungi, moulds, pollen, starch grains, mineral particles, etc.—but the method is not sufficiently delicate for the detection of bacteria and their spores. At the present time cultural methods are employed practically to the exclusion of all others.

1. Original methods.

I. Pasteur's method.—Pasteur's method which is the oldest of all consists in the use of long-necked flasks one-third filled with veal broth. The neck of each flask is drawn out to a point, the flask and its contents are sterilized and the point sealed in a small flame while the broth is still at the boiling point: in this way all the air is driven out. It is now only necessary to carry the flask to the place where the air is to be examined and to break off the fine point. The air with the particles in suspension will rush into the flask, and as soon as it is full the point is sealed again,

and the flask put on one side: the same process is repeated with a number of flasks. In a short time the medium in some of the flasks will become cloudy, and from the number which show this turbidity the number of organisms contained in the air can be roughly deduced.

Thus, for example, suppose that 50 flasks each containing approximately 500 c.c. of air were used and that 20 of them became cloudy: the calculation would be as follows:— 25 litres of air have given 20 organisms; 1 cubic metre therefore contains very approximately $\frac{2}{25} \times 1000$ that is 800 organisms.

The method necessitates the use of a great deal of material and is cumbersome and from the practical point of view, impossible.

II. Koch's method.—Koch's method consists in exposing to the air for different periods of time a number of gelatin plates and studying the colonies which subsequently develop on them. This method does not allow of quantitative estimations.

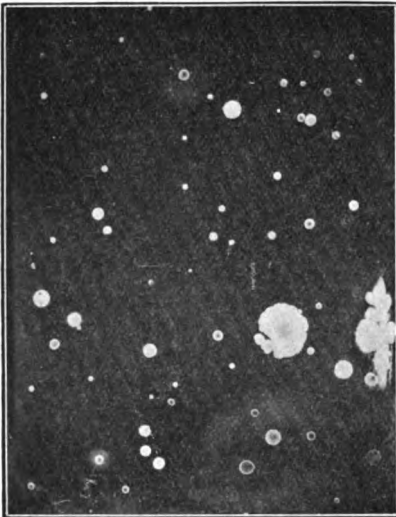

FIG. 409.

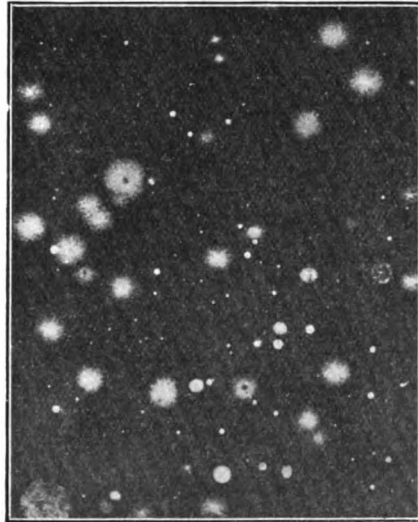

FIG. 410.

FIGS. 409, 410.—An agar plate and a gelatin plate exposed to the air side by side and then incubated at 37° C. and 20° C. respectively. Note the greater number of bacteria on the former and of moulds on the latter.

III. Hesse's method.—Hesse's method which has the advantage of being simple is based upon the principle of the aëroscope. Unfortunately the results obtained are only approximate.

Take a piece of glass tubing 4–5 cm. in diameter and 50–70 cm. long (fig. 411). Plug one end of the tube with an india-rubber plug through which a piece of glass tubing plugged with wool at the outer end is passed.

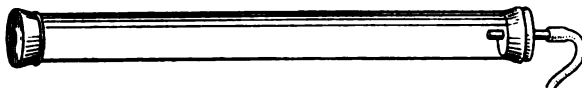

FIG. 411.—Hesse's tube.

Cover the other end with two pieces of india-rubber one over the other the inner being perforated with a hole about 1 cm. in diameter. Sterilize the apparatus and then pour about 50 c.c. of liquefied sterile gelatin into the tube through the perforated piece of india-rubber. Replace the second sheet of india-rubber at once and keep the tube in an horizontal position until the gelatin has set. The gelatin should form

a smooth uniform layer on the lower surface of the tube not deep enough to reach the orifice of the small glass tube nor the opening in the india-rubber at the other end. [It will be found more satisfactory to warm the tube before pouring the gelatin into it and then holding it horizontally to rotate the tube until the gelatin has set so that the medium forms a thin coating over the whole of the interior.] The apparatus is now ready for use. When about to carry out an experiment, remove the outer piece of india-rubber, attach the outer end of the small glass tube to an aspirator and draw 10–15 litres of air slowly through the tube. The air enters the hole in the india-rubber capsule and passes over the surface of the gelatin on which it is intended that the suspended dust should be deposited. When the required volume of air has been drawn through, the outer india-rubber capsule is replaced and the tube incubated in the cool incubator (20° C.). Colonies begin to appear on the gelatin in the course of a day or two and if the technique was satisfactory should be more numerous at the end at which the air entered. The colonies can be counted and any which it may be desired to investigate further, picked off.

If, for example, 15 litres of air have been aspirated and 6 colonies of bacteria and 10 moulds are subsequently counted on the gelatin the air will have contained approximately

$$\frac{6}{15} \times 1000 = 400 \text{ aerobic bacteria per cubic metre.}$$

$$\frac{10}{15} \times 1000 = 666 \text{ moulds per cubic metre.}$$

In practice, however, it happens that many organisms stick to the glass wall of the tube and so do not enter into the computation [this source of error is avoided if the medium be coated over the whole surface]: further, if the experiment be continued for any length of time the gelatin will become dry and fail to act as a satisfactory culture medium and lastly, the current of air must pass very slowly otherwise the organisms suspended in it will be carried through the tube without being deposited. [Two other objections may be raised, namely the difficulty of reaching the colonies should it be desirable to sub-cultivate them and the fact that some organisms rapidly liquefy the gelatin and render the experiment useless.]

2. Methods employed at the present day.

The methods just described have now been superseded by others which depend upon removing the organisms contained in the air either by bubbling the latter through a viscous fluid or by filtering it through a powder. By adopting either of these methods all the organisms suspended in a given volume of air can be collected in a small space, being either disseminated in the liquid or mixed with the powder as the case may be. It will then only be necessary to proceed on the lines already laid down in the sections dealing with the isolation of organisms and with the examination of water. It is always well to sow both agar and gelatin plates since the latter generally liquefy in a short space of time.

In carrying out these experiments with air some form of aspirator is necessary. For choice, a water aspirator would be used such as is to be found in chemical laboratories. With the aid of this apparatus the volume of air aspirated can be very accurately measured. An ordinary water exhaust pump can also be used. In this case it will of course be necessary to interpose between the liquid through which the air is to bubble and the pump a gasometer which will record the volume of air aspirated. [A still more simple and quite satisfactory method consists in using a large glass barrel fitted with a tap below and stoppered above with an india-rubber plug through which a narrow piece of glass tubing is passed, such as is used in operating theatres for storing antiseptics. This vessel can be graduated once for all by pouring in measured volumes of water and marking the level on the glass with a carburundum pencil. If it is required to aspirate, say, 10 litres of air, the vessel is filled with water up to the 10 litre mark, the apparatus is then attached to the small glass tube above and by regulating the flow of water from the tap below the air can be aspirated at any speed which is considered desirable. For the examination of air in places where it is inconvenient to

use any large piece of apparatus Andrewes uses a large metal aspirating syringe of known capacity. By means of a side tap the aspirated air can be expelled without disconnecting the syringe from the filter tube.]

Whatever the form of aspirator used the air should always be aspirated slowly and regularly so that the bubbles burst one by one in the liquid through which it is passed. There are various other pieces of apparatus which can be used for the same purpose.

A. Methods based upon filtration.

I. Filtration through insoluble substances. 1. Petri's method.—Take a piece of glass tubing about 15 mm. in diameter and 10 cm. long and at each end arrange a pair of wire gauze plugs (B_1, B_2, B_3, B_4 , fig. 412) leaving a space of about 3 cm. between each pair (C_1, C_2) and fill these two spaces with very fine sand previously heated to redness. Plug the two ends of the glass tube with wool and sterilize the apparatus in an hot air sterilizer. When it has cooled replace one of the wool plugs with a sterile perforated india-rubber bung, D, through which a piece of glass tubing, F, plugged with wool is passed. To use the apparatus, attach the end of the small glass tube, F, to an aspirator, take the wool plug out of the other end and slowly aspirate 100 litres of air. When the aspiration is completed the sand is mixed with sterile gelatin and a number of plates poured. The method is complicated and of little use in practice.

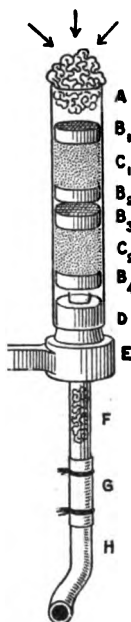

FIG. 412.—Petri's sand filter for the examination of air.

2. Frankland's method.—The tubes are similar to those used by Petri but glass wool or asbestos is substituted for the sand: this does away with the necessity for the metal gauze. After the air has been aspirated, the filtering medium is shaken up in a known quantity of broth and the latter is then used for sowing gelatin plates. This method though very simple is not exact since organisms stick to the glass wool or the asbestos and do not become suspended in the broth.

II. Filtration through soluble substances (Pasteur).—By using soluble instead of insoluble substances the distribution of the organisms in the gelatin is made more certain and their enumeration is very accurate. Unfortunately the method is not applicable when the atmosphere contains much moisture since in that case the filtering substances become moist, deliquesce and no longer act as a filter.

Sulphate of sodium is ordinarily used as the filtering medium. The salt is fused in an iron vessel, powdered and sifted and then introduced into a glass tube of the shape shown in fig. 413. One end of the tube is plugged



FIG. 413.—Glass tube for soluble filters.

with wool and beyond this is a constriction against which rests a small piece of asbestos and then powdered sodium sulphate to a depth of about 8 cm., the other end of the tube is drawn out and sealed in the flame. The apparatus is sterilized in the hot air sterilizer. To use it, the powder is shaken down against the asbestos plug by gently tapping the tube, the pointed end of the tube is broken off and the other, plugged, end connected to an aspirator.

When the desired volume of air has been aspirated the powdered sodium sulphate is dissolved in a known volume of broth and plates are sown with measured quantities of the liquid. As a control the asbestos plug is transferred with sterile forceps to a tube of broth and this of course should remain sterile.

[**III. Andrewes' method.**—The filtering medium consists of a mixture of glass wool (3-4 parts) and cane sugar (1 part). A straight piece of glass-tubing is used without any constriction and the medium rammed in fairly tightly. After plugging the ends with wool the apparatus is sterilized at 120° C. and after aspirating the air through it the mixture is pushed out with a sterile glass rod into a plate of melted sterile gelatin.]

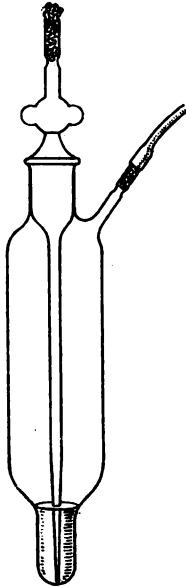

FIG. 414.—Straus and Wurtz' apparatus.

B. Methods based upon bubbling the air through liquids.

I. Method of Straus and Wurtz.—The apparatus consists of a glass cylinder with an appendix at its lower end filled with 10 c.c. of liquefied gelatin the surface of which is covered with a few drops of oil.

The upper part of the cylinder is furnished (1) with a lateral tubulure plugged with wool and (2) with a central ground glass opening which is hermetically closed with a glass tube—reaching below the bottom of the gelatin in the appendage and above projecting beyond the cylinder—which is plugged with wool. The apparatus is sterilized in the autoclave. When required for use, the lower part of the cylinder is placed in water at about 40° C. to liquefy the gelatin, the lateral tubulure is attached to an aspirator

and the wool plug removed. The aspirated air passes through the central tube B and bubbles through the gelatin in which it deposits the organisms suspended in it. (The layer of oil prevents the gelatin frothing.) When 10 litres of air have been aspirated the aspirator is disconnected, and air is gently blown in through the lateral tubulure, thus driving the gelatin up into the central tube. This operation is repeated several times in order to thoroughly wash the tube. Finally, plates are poured with the gelatin. [The apparatus can be used for the simple enumeration of organisms, the gelatin in this case being run over the sides of the cylinder after the fashion of an Esmarch's roll tube.]

This apparatus is very convenient but many organisms are arrested in the delivery tube which is very long and has an irregular surface, so that the results are not very accurate; moreover the apparatus is only available for small volumes of air.

II. Miquel's method.—The apparatus consists of a Pasteur flask with two lateral tubulures attached to opposite sides of its upper part and with a central tube dipping to the bottom. A ground glass cap closes the central tube: one of the lateral tubulures is plugged with wool and the other, used

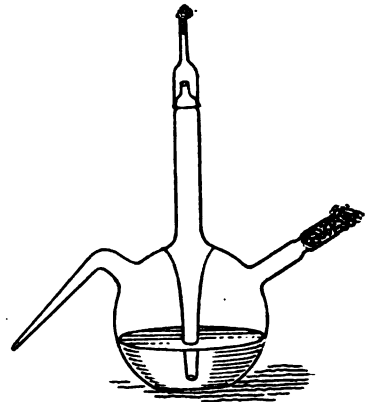

FIG. 415.—Miquel's apparatus.

for distributing the medium at the end of the experiment, is drawn out and sealed in the flame.

Thirty c.c. of water are poured into the flask and then sterilized in the autoclave. To use the apparatus connect the plugged tubulure with an aspirator, remove the glass cap from the central tube, and start the aspirator: the air now bubbles through the water in the flask and when sufficient air has been drawn through, wash out the central tube several times by blowing gently through the lateral tubulure. Then break off the sealed end of the other lateral tube and distribute the contents of the flask into a number (30 or 40) of flasks containing broth; these flasks are then incubated. The method is not accurate because the mere dipping of the tube into the liquid is insufficient to entrap all the organisms and consequently many escape detection.

III. Laveran's method. Method recommended.—Laveran employs a piece of apparatus which while giving very accurate results, is simple in construction and not easily broken. Two glass tubes closed below are connected together at the junction of the middle and upper thirds by an horizontal tube. Each of the vertical tubes is plugged at its upper end with an india-rubber stopper through which a pipette reaching to the bottom of the tube is passed. One of the tubes has a 10 c.c. mark on the glass and one of the pipettes is graduated in tenths of a cubic centimetre. The upper end of each pipette is plugged with wool. 10 c.c. of a 1 per cent. solution of sugar in water are poured into the graduated tube. The apparatus is then autoclaved.

For use, remove the wool plug from the pipette dipping into the sugar solution and connect the other with an aspirator. The aspirated air bubbles through the solution, passes into the first tube through the horizontal connecting tube, descends in the other limb and escapes through the pipette connected with the aspirator. A very large volume of air can thus be aspirated.

When sufficient air has bubbled through gently aspirate the sugar solution into the entry pipette to wash it, then run the fluid into the second tube and so into the second pipette, and repeat this several times in order to collect all the organisms which have been deposited on the glass. It only remains now to remove the liquid by means of the graduated pipette and to distribute it into different culture media (gelatin and agar plates, etc.).

Suppose, for example, that 200 litres of air have been aspirated and twelve colonies have developed on a gelatin plate sown with one cubic centimetre of the sugar solution, it follows that:

200 litres of air contain 12×10 aerobic organisms,
1 cubic metre therefore contains $12 \times 10 \times 5$ aerobic organisms.

The advantages of the method are that it is available for large volumes of air and provides plenty of material for sowing cultures: thus it fulfils the requirements of special investigations for the detection of pathogenic micro-organisms.¹

¹ For details reference must be made to the chapters devoted to the consideration of the various pathogenic micro-organisms. For the detection of the tubercle bacillus it will, of course, be necessary to inoculate animals.

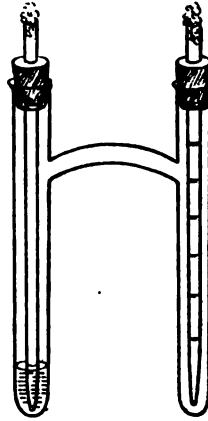

FIG. 416.—
Laveran's tube.

INDEX.

- Abbe's apochromatic objectives, 115.
 — sine law for aplanatism, 110.
 Abe's agar, 639.
 Abscesses, collection of pus from, 197.
 — spontaneous, in animals, 159.
 Absorption of agglutinins, method of, 436.
 — — — (aertrycke bacillus), 441.
 — — — (paratyphoid A bacillus), 427.
 — — — (— B —), 436.
 — — — (typhoid bacillus), 389.
 — — oxygen from culture media, 89.
Acanthia lectularia and spirochætosis, 711.
Acanthia, spontaneous infection of rabbits
 with, 159.
 Acetic perchloride as hardening reagent,
 189.
 — violet, 148.
 Acetone alcohol, 143.
 Achalmé's rheumatism bacillus, 569, 570.
 — blood-broth medium, 34.
Achorion arloingi, 692.
 — *quinckeanum*, 692.
 — *schœnleini*, 690.
 Achromatism, 114.
 Acid alcohol, 346.
 Acid dyes, 136.
 Acid-fast bacilli, 345.
 — — — in urine, 343.
 — — — — butter, 338.
 Acne varioliforme, 766.
 Acquired immunity, 221.
 Actino-bacillosis, 661.
Actinobacillus lignièresi, 661.
 Actino-congestine, 224.
Actinomyces bovis, 656.
 Actinomycosis, 656, 665.
 — parasites of, 660.
 Actinomycotic mycetoma, 665.
 Action of oxygen on potassium pyrogallate,
 89.
 — — vitality of micro-organisms, 75.
 Active immunity, 221.
 Acute anterior poliomyelitis, virus of, 844.
Adelea (genus), 766.
 Agar-agar, 42.
 Agar, Abe's, 639.
 — ascitic, 53.
 — — (Ruediger's), 585.
 — blood, 53.
 Agar, gelatin, 43, 44.
 — glucose-glycerin, 44.
 — glycerin, 44, 693.
 — Heiman's, 639.
 — Hesse's (tubercle bacillus), 317.
 — Král's, 639.
 — Leipschutz's, 639.
 — litmus, 57.
 — media, 42.
 — Malm's, 44.
 — Nasstikoff's, 639.
 — Sabouraud's, 673, 681.
 — Salomonsen's, 44.
 — serum, 53.
 — Steinschneider's, 640.
 — Tochtermann's, 317.
 — Wertheim's, 638.
 — Wildbolz's agar, 639.
 Agglomeration (*T. brucei*), 812.
 — (*T. lewisi*), 807.
 Agglutinins, 225.
 — heterologous, 389.
 — homologous, 389.
 — primary, 389.
 — secondary, 389.
 — specific, 389.
 Agglutination, mechanism of, 226.
 — (measurement of titre), 388.
 — of micro-organisms (*see the several
 chapter headings*).
 Agressins, 222 (footnote).
 Aertrycke bacillus, 438.
 Aërobic micro-organisms, definition of, 28.
 — — isolation of, 76.
 — — methods of sowing and cultivat-
 ing, 67.
 Æstivo-autumnal fever, 780.
 Air (bacteriological examination), 862.
 Albuminous media, 45.
 Alcohol ether, 141.
 Alcoholic staining solutions, 137.
 Aleppo boil, 802.
 Alexin, 229.
 Alopecia areata, 692.
 Amboceptor, 229.
 American diphtheria bacillus, 257, 259.
 — relapsing fever, 712.
 — trypanosomiasis, 823.
Amœba buccalis, 745.

- Amoeba coli*, 747.
 — *dysenterica*, 747.
 — *histolytica*, 748.
 — *pelaginia*, 747.
 — *princeps*, 745.
 — *urogenitalis*, 745.
 — *vaginalis*, 745.
- Amœbic dysentery, 356.
 Amœboid parasite of malaria, 774.
 Anæmia of horses, virus of, 842.
 Anaerobic micro-organisms, action of oxygen on, 87.
 — — cultivation of, in liquid media, 92.
 — — — — in solid media, 99.
 — — — — on solid media, 100.
 — — — — growth of, in presence of oxygen, 87.
 — — isolation of, 87.
 — — — — (Plate method), 101.
 — — — — (Tube method), 103.
 — — in gangrene, 569.
- Anaphylaxis, 224.
 Anasarca of the horse, 607.
 Andrewes' method (examination of air), 866.
 Andrewes and Horder's classification of streptococci, 601.
 Angers vibrio, 492.
 Angina, Vincent's, 574.
 "Angines sableuses," 631.
 Angular aperture, 112.
 Aniline dyes (*see* Stains), 136.
 — oil water, 139.
 Animal inoculation, 156.
 Animals, diphtheria bacillus in, 246.
 Anopheles mosquito, 776, 777.
Ante mortem (agonic) infections, 393.
 Anthrax, 517.
 — examination of carcasses dead of, 534.
 — symptomatic, 552.
 Antiformin (isolation Tubercle bacillus), 341.
 Antigen, 229, 235.
 Antiseptics, sterilization by, 26.
 Antitoxin (*Bacillus botulinus*), 551.
 — (diphtheria), 265.
 — — anaphylaxis following, 224.
 — — dried, 266.
 — — properties of, 266.
 — — unit of, 268.
 — — in milk, 266.
 — (Tetanus), 545.
 Antitoxins, 224.
 Antityphoid vaccination, 380.
 — — effects of, 382.
 — — Wright-Leishman method, 381.
 — — Besredka's method, 382.
- Antibody, 229.
 Anti-collysin, 399.
 Anti-scarlatinal vaccination, 604.
 Antityphoid serum (Besredka's), 384.
 — — (Chantemesse's), 383.
 Antitypholytic serum, 379.
 Ants and plague, 462.
 Apertometer, 112.
 Apes, natural plague in, 460.
 Aphthous fever, virus of, 838.
- Aplanatic image, 110.
 Aplanatism, sine condition for, 110.
 Apochromatism, 114.
 Apochromatic objectives, 115.
 Appearances presented by micro-organisms in culture, 73.
 Aqueous humour, collection of, 197.
 — solutions of dyes, 137.
Argas reflexus and *Sp. marchouxi*, 718.
 — *persicus* and *Sp. marchouxi*, 718.
 Arloing's vaccines for quarter ill, 556.
 — serum for quarter ill, 559.
 — method of immunization of cattle against the tubercle bacillus, 333.
 — homogeneous cultures (Tubercle bacillus), 335.
 Aronson's antistreptococcal serum, 607.
 d'Arsonval's incubator, 63.
 — — electric, 65.
 Arterial inoculation, 173.
 Arthrospore, 145.
 Artichoke as culture medium, 375.
 Asotic fluid, collection of, 198.
Ascophora nigricans, 678.
 Asiatic cholera, 488.
 Aspergillary mycetoma, 665.
Aspergillus (genus), 695.
 — *bouffardi*, 665.
 — *concentricus*, 700.
 — *fumigatus*, 695.
 — *glaucus*, 695.
 — *herbariorum*, 695.
 — *lepidophyton*, 700.
 — *malignus*, 695.
 — *nidulans*, 699.
 — *niger*, 699.
 — *pictor*, 698.
 — *repens*, 695.
- Aspiration, filtration by, 19.
 Aspirator, Potain's, 82.
 Asses, collection of blood from, 193.
 — handling of, 164.
 — Nagana in, 811.
 Asylum dysentery, 356.
Atelosaccharomyces bussee-buschki, 706.
 Auer gas burner, 118.
 Autoclaves, 9.
 Avian pasteurilla, 447.
 — tubercle bacillus, 291.
 — tuberculosis, 296.
- Babès' granules, 252.
 — incubator, 63.
 — temperature regulator, 59.
Babesia, 787 footnote.
 — *bigemina*, 787.
 — *ovis*, 791.
 — *parva*, 793 footnote.
- Bacillary dysentery, 356.
 — pseudo-tuberculosis, 347.
 Bacille septique aérobie, 578.
Bacillus aërobicus sepiis, 578.
 — *aërogenes capsulatus*, 569.
 — *anthracis*, 517.
 — — *brevigemmans*, 524.
 — *asciformis*, 693.
 — *botulinus*, 549.

- Bacillus chauruzi*, 552.
 — *cholerae suis*, 438.
 — *coli*, 393.
 — *diphtheriae*, 245.
 — *entericae febris*, 366.
 — *enteritidis aërytycke*, 438.
 — — gaertner, 442.
 — — pseudo-gaertner, 444.
 — *dysentericae epidemicae*, 356.
 — — El Tor No. 1, 365.
 — F, 437.
 — *fragilis*, 573.
 — *funduliformis*, 572.
 — *fusiformis*, 574.
 — *hæmoglobinophilus canis*, 510.
 — *hastilis*, 574.
 — *icteroides*, 445.
 — *influenzae*, 504.
 — *lactis aërogenes*, 415.
 — *lepra*, 348.
 — *maligni oedematis*, 561.
 — *mallei*, 480.
 — *paratyphosus A*, 423.
 — — B, 431.
 — *perfringens*, 569.
 — *pertussis* Eppendorf, 510.
 — *pestis*, 460.
 — *phlegmonis emphysematosa*, 569.
 — *pæciloides*, 571.
 — *pseudo-diphtheriae*, 247, 273.
 — *pseudo-oedema*, 571.
 — *pseudo-tuberculosis rodentium*, 160, 474.
 — *pyocyanus*, 276.
 — *ramosus*, 571.
 — *serpens*, 572.
 — *smegma*, 346.
 — *suipestifer*, 438.
 — *tetani*, 536.
 — *thetoides*, 572.
 — *tuberculosis*, 289.
 — *typhi murium*, 444.
 — *typhosus*, 366.
- Bacillus of acute contagious conjunctivitis**, 510.
 — — blue pus, 276.
 — — coscoroba swan disease, 452.
 — — Danysz, 444.
 — — distemper, 457.
 — — — (M'Gowan), 459.
 — — duck cholera, 452.
 — — epizootic dysentery in turkeys, 452.
 — — ferret septicaemia, 453.
 — — fowl cholera, 447.
 — — — enteritis, 452.
 — — Friedländer, 415.
 — — glanders, 480.
 — — green diarrhoea, 400.
 — — hæmorrhagic septicaemia of ducks and fowls, 453.
 — — hog cholera, 438.
 — — Karlinski, 354 footnote.
 — — malignant oedema, 561.
 — — mouse septicaemia, 288.
 — — ozæna, 419.
 — — pseudo-tuberculosis, 160, 474.
- Bacillus of psittacosis**, 445.
 — — quarter ill, 552.
 — — rabbit septicaemia, 453.
 — — rhinoscleroma, 418.
 — — seborrhœa oleosa, 692.
 — — soft sore, 513.
 — — sub-acute conjunctivitis, 511.
 — — swine erysipelas, 283.
 — — symptomatic anthrax, 552.
 — — Tavel, 306 footnote.
 — — the peladic utricule in alopecia, 692.
 — — verruga peruana, 346.
 — — whooping cough, 511.
 — — wood pigeon disease, 452.
- Bacteria**, 136.
 — — vitality of phagocytid, 222.
- Bactericidal substances**, origin of, 223.
 — — serums, 227.
- Bacteriolysis**, mechanism of, 228.
- Bacteriolytic serums**, preparation of, 236.
- Bacteriotropins**, 239.
- Bacterium murisepticum**, 288.
 — — photometricum, flagella of, 148.
- Balantidium coli**, 356, 830.
 — — minutum, 831.
- Balbiana**, 756.
 — — gigantea, 758.
 — — mucosa, 758.
 — — siamensis, 758.
- Bald ringworm**, 688.
- Baléri**, 814.
- Barbeiro**, 822.
- Barbone**, 455.
- Barrel-shaped distortion of microscopical image**, 109.
- Barrouzia** (genus), 766.
- Barsiekow's culture medium**, 57.
- Basic dyes**, 136.
- Bassett-Smith's vaccine** (Mediterranean fever), 478.
- Bats**, Hæmatozoon of, 781.
- Baumgarten's stain** (Leprosy bacillus), 350.
- Báyon's culture medium** (Leprosy), 353.
- Beef broth culture medium**, 30.
- Bee disease** (*Mucor mucedo*), 677.
 — — (*Nosema apis*), 753.
- Beggiatoa roseopersinica**, flagella of, 148.
- von Behring's method of standardizing diphtheria antitoxin**, 267.
 — — — immunizing cattle against tuberculosis, 330.
- Beraneck's tuberculous acido-toxin**, 329.
- Berkefeld filter**, 15.
 — — cleansing of, 18.
- Bernard's bit**, 164.
- Bertarelli's stain** (Amøbæ), 749.
 — — (Coccidia), 761.
- Bertarelli, Volpino and Bovero's stain** (*T. pallidum*), 730.
- Besredka's antistreptococcus serum**, 609.
 — — antityphoid serum, 384.
 — — sensitized vaccine in cholera, 498.
 — — — — dysentery, 362.
 — — — — enteric fever, 383.
 — — — — plague, 470.
 — — — — streptococcal infections, 605.

- Besredka's typhoid endotoxin, 379.
 Besson's method of preparing malignant oedema toxin, 566.
 — — isolating the typhoid bacillus from water, 405.
 Besson and Pourrat's method of intrapleural inoculation, 179.
 Benignetti and Gino's method for staining flagella, 152.
 Bezançon and Griffon's blood-agar, 53.
 — — — (Tubercle bacillus), 317.
 — — egg medium (Tubercle bacillus), 316.
 Bichromate solution, 131.
 Bile as a culture medium, 410.
 — — — for cholera, 501.
 — — — for the typhoid bacillus, 372.
 — — — for the tubercle bacillus, 318.
 Biliary fever of dogs, 791.
 Biliary passages, inoculation into the, 177.
 Biochemical reactions (*see* the several chapter headings).
 Biological properties (*see* the several chapter headings).
 Birds, bleeding of, 195.
 — coccidiosis in, 764.
 — hæmatozoa in, 781.
 — handling of, 165.
 — intra-venous inoculation of, 173.
 — *post mortem* examination of, 188.
 — tuberculosis in, 296.
 — trypanosomes in, 823.
 Bird plague, virus of, 839.
 Black mycetoma, 665.
 — quarter, 552.
 — tongue, 678, 706.
Blastomyces dermatitis, 706.
Blastomyces and cancer, 707.
Blastomycetes, 701.
 Blastomycotic dermatitis, 706.
 Blastomycosis, 706.
 Blood as a culture medium, 36.
 — agar, 53, 639.
 — broth, 34, 638.
 — collection of, for bacteriological examination, 192.
 — — from a vein at the bend of the elbow, 193.
 — — (Næggerath and Staehelin's method—Syphilis), 733.
 — — (Nattan-Larrier and Bergeron's method—Syphilis), 733.
 — — (Ravaut and Ponselle's method—Syphilis), 733.
 — defibrination of, 36.
 — films, preparation of, 204.
 — — staining of, 206.
 — — — for gram-negative organisms, 209.
 — — unstained preparations, 203.
 Blue pus, 276.
 — tongue, 839.
Bodo urinarius, 827.
 Bøhmer's hæmatoxylin, 218.
 Böttcher's hollow-ground slide, 134.
 Bohr's temperature regulator, 60.
 Bombicci's dish (Isolation of anaerobes), 101.
 Bone marrow, bacteriological examination of, 187.
 Bonome's streptococcus, 610.
Boophilus annulatus and *P. bigeminum*, 787.
 — *decoloratus*, 787.
 — *decoloratus* and *S. theileri*, 719.
 — *dugesi* and *P. bigeminum*, 787.
 Borax blue, 139, 771.
 — methylene-blue, 514.
 Bordet-Gengou reaction, 232.
 Bordet-Gengou's bacillus of whooping cough, 511.
 Borrel's blue, 139, 772.
 — broyeur, 170.
 — stain (Sporozoa), 761.
 Borrel and Burnett's stain (*T. pallidum*), 728.
 Bottle for cultivation of anaerobic microorganisms, 94.
 Botulism, 549.
 Bougie, porous porcelain (*see* Filters), 14.
 Bovine farcy, 480, 667.
 — pasteurellosis, 455.
 — piroplasmosis, 787.
 — tubercle bacillus, 289.
 — tuberculosis, 294.
 Bovo-vaccin, von Behring's, 330.
 Bowhill's stain for flagella, 152.
 Bradford disease, 517.
 Branching bacilli, 245 footnote.
 — diphtheria bacilli, 251.
 — tubercle bacilli, 313.
 Bread as a culture medium, 56.
 Breeding of small animals, 159.
 Brightness of image, 114.
 Brilliant-green media, 411.
 Brison coccus, 249.
 Broth, 30.
 — arsenical, 375.
 — for diphtheria, 253.
 Broyeur, Borrel's, 170.
 Brush rats, natural plague in, 461.
 Bubonic plague, 460.
 Buchner's method (Cultivation of anaerobes), 95.
 — gelatin, 41.
 Buffaloes, pasteurellosis in, 455.
 — plague in, 461.
 — sarcosporidiosis in, 758.
 Bugs and kala azar, 799, 801.
 — and oriental sore, 802.
 — and plague, 462.
 — and spirochetosis, 711.
 — and trypanosomiasis, 822.
 Bug of Mianeh (*Argas persicus*) and spirochetosis, 712.
 Bulb pipette, 22.
 Bulloch's apparatus (Cultivation of anaerobes), 96, 100, 102.
 Bumm's serum medium (Gonococcus), 640.
 Bunge's stain for flagella, 151.
 Burri's method (Isolation of microorganisms), 83.
 Bursattee, 674.
 Butter, acid-fast bacilli in, 338.

- Caffeine media, 375, 408.
 Cages for experimental animals, 157.
 Calmette's bile medium (Tubercle bacillus), 318.
 — ophthalmal-reaction in tuberculosis, 327.
 — tuberculin, 328.
 Calmette and Salimbeni's plague vaccine, 470.
 Cambier's method (Isolation of the Typhoid bacillus), 406.
 — (Motility of micro-organisms), 154.
 Cambridge "rocking" microtome, 211.
 Camels and surra, 814.
 Camera lucida for measuring magnification, 121.
 — — — microscopical objects, 122.
 Camphor as an antiseptic, 26.
 Camus' method for collection of serum, 197.
 Canada balsam, 142.
 Cancer, filtrable viruses in, 840.
 — *Saccharomyces* and, 707.
 — spirochaetes in, 735.
 Canguary, 822.
 Canine leishmaniosis, 801.
 — pasteurellosis, 456.
 — piroplasmosis, 791.
 — typhoid, 457.
 Cantacuzène's stain (*T. pallidum*), 717.
 Capaldi's egg medium (Tubercle bacillus), 316.
 Caps, india-rubber, 29.
 Capsule, Wright's blood-collecting, 192.
 Capsules, staining of, 147.
 Cappybara and Mal de Caderas, 814.
 Caratés, 698.
 Carbohydrate media, 34.
 — — sterilization of, by filtration, 35.
 Carbolic acid, use of, in preparation of vaccines, 27.
 Carbolic-agar, 407.
 — -broth, 402.
 — -gelatin, 402.
 Carbol-crystal-violet, 138.
 — -fuchsin, 138.
 — — dilute, 138.
 — -gentian-violet, 138.
 — -methylene-blue (Kühne's), 138.
 — -thionin, 138.
 Carbonated broth, 35.
 Carbonic anhydride, generation of, 89.
 — — sterilization by, 11.
 Carceag, 791.
 Cardiac puncture in guinea-pigs, 194.
 — — rabbits, 195.
 Carmine (Orth's), 218.
 Carmine, alcohol (Orth's), 218.
 Carnot and Garnier's tube, 155.
 Carotid artery, inoculation into, 174.
 Carp, microsporidiosis in, 754.
 — myxosporidiosis in, 756.
 Carriers in cholera, 488.
 — enteric fever, 367.
 — — (complement fixation reaction), 390.
 Carriers of meningococcal infections, 645.
 — in paratyphoid A fever, 423.
 — — B fever.
 Carrot, infusion of, 37.
 Castellani's absorption of agglutinins (*see* Absorption of agglutinins), 427.
 Castor oil, refractive index of, 119.
 Catarrhal fever of sheep, 839.
 Catheterization of the œsophagus, 181.
 Cats as experimental animals, 157.
 — coccidiosis in, 764.
 — diphtheria in, 246.
 — distemper in, 457.
 — handling of, 164.
 — leishmaniosis in, 802.
 — natural plague in, 461.
 — ringworm in, 687.
 — tuberculosis in, 296.
 Cattle as experimental animals, 156.
 — collection of blood from, 48, 193.
 — East coast fever of, 793.
 — Gaertner's bacillus in, 442.
 — handling of, 165.
 — intra-venous inoculation of, 173.
 — pasteurellosis of, 455.
 — plague in, 461.
 — red water of, 787.
 — Rhodesian fever of, 793.
 — spirochaetosis of, 719.
 — tropical piroplasmosis of, 793.
 — trypanosomiasis of (Souma), 814.
 — tuberculosis of, 294.
 Cattle plague, virus of, 839.
 Cedar wood oil, refractive index of, 119.
 Cell inclusions in rabies, 841.
 — — swine fever, 843.
 — — trachoma, 843.
 Central nervous system, examination of, 187.
Ceratomyxa appendiculata, 756.
 — *inæqualis*, 756.
 — *linospora*, 756.
Ceratophyllus fasciatus on rats, 461.
 — — and *Trypanosoma lewisi*, 805.
Cercomonas hominis, 825.
 — *intestinalis*, 825.
 — *termo*, 826.
 Cerebro-spinal fluid in general paralysis, 738.
 Cerrito's stain for flagella, 151.
 Chagas' disease, 822.
 Chamberland's autoclave, 9.
 — bougie (filtering), 15.
 — filtering apparatus, 24.
 — flask, 46.
 Chamberland and Roux's asporogenic anthrax bacillus, 527.
 Chancel's temperature regulator, 59.
 Chantemesse's antityphoid serum, 383.
 — hot air sterilizer, 5.
 — method of isolating aerobic micro-organisms, 82.
 — methods of isolating the typhoid bacillus, 85, 407, 412.
 — typhoid toxin, 377.
 Chantemesse and Widal's method of isolating the typhoid bacillus, 402, 407.

- Chemotaxis, 222.
 Chenzinsky's stain for blood, 210.
 Chicken broth, 32.
Chilodon dentatus, 831.
 China green medium, 410.
 — ink in detection of *T. pallidum*, 728.
Chlamydozoa, 843.
 Chloroform as an antiseptic, 27, 46.
 Cholera vibrio, 488.
 — intestinal, 489.
 Choleraic peritonitis, experimental, 489.
 — septicæmia, experimental, 489.
 Choquet's gelatin, 41.
 Chromatic aberration, 110, 114.
 Cibil's extract, 34.
Cimex lectularius and Indian kala azar, 799.
 — — and Mediterranean kala azar, 801.
 — — and plague, 462.
 — — *rotundatus* and Indian kala azar, 799.
 — — and Mediterranean kala azar, 801.
 — — and oriental sore, 802.
 Citrate solution, 169, 804.
 Clado's urinary bacillus, 393.
 Classification of diphtheria bacilli, 250.
 — dysentery bacilli, 357, 360.
 — malarial parasites, 780.
 — streptococci, 596, 601.
 — the parasites of actinomycosis, 660.
 — — mycetoma, 666.
 — the trichophyta, 682.
 — the tripanosomidæ, 804.
 Claudius' stain for films, 144, 209.
 — — sections, 219.
 Clavelization, 840.
 Coagulation of blood, prevention of, 36.
 — serum, 51.
 Co-agglutinins in enteric serums, 389.
 — paratyphoid A fever, 426.
 — experimental aertrycke serums, 441.
 — — meningococcal, 649.
 — — paratyphoid B, 435.
 Coal gas (Cultivation of anaërobic micro-organisms), 89.
 Cobbett's bulb, 18, 19, 24, 45.
 — classification of diphtheria bacilli, 250.
 — medium for diagnosis of diphtheria, 271.
 Coccidia in tumours, 766.
Coccidiidea, 760.
 Coccidioidal granuloma, 706.
Coccidioides, 671.
 — *immilis*, 671.
 Coccidiosis in man, 761.
 — rabbits, 160.
Coccidium, 760.
 — *avium*, 764.
 — *bigeminum*, 760, 764.
 — *cuniculi*, 760.
 — *falciforme*, 764.
 — *hominis*, 761.
 — *jalinum*, 764.
 — *oviforme*, 160, 760.
 — *perforans*, 761.
 — *pfeifferi*, 764.
 — *proprium*, 764.
 — *salamandrae*, 764.
Coccidium, tenellum, 764.
 — *truncatum*, 764 footnote.
 Coccoid granules in spirochetes, 712.
 Coccus Brisou, 249.
 Cochin China diarrhœa, 827.
 Cockroaches and plague, 462.
 Cohn's culture medium, 38.
 Cold-blooded vertebrata, Hæmogregarines in, 783.
 — — Trypanosomes in, 824.
 — — Tuberculosis in, 296.
 Colilysin, 398.
 Collection of material for bacteriological examination, 191.
 — — *post mortem*, 185.
 — — from suspected cases of diphtheria, 270.
 — — — syphilis, 732.
 — — water for bacteriological examination, 851.
 Collodion sacs, 174.
 Coloured media, 56.
Colpoda cucullus, 831.
 Coma, 110.
 Comma bacillus, 488.
 Compensating collar, 115.
 — oculars, 115.
 Complement, 229.
 — fixation reaction, 232.
 — — practical applications, 238.
 — preparation of, 235.
 — titration of, 235.
 Condenser, Abbe's, 106.
 Condensers for dark-ground illumination, 125.
 Conditions essential to growth of micro-organisms, 72.
 Congress of Hygiene, 1894, 265.
Conorrhinus megistus and Chagas' disease, 822.
 — *rubrofaciatus* and Indian kala azar, 800.
 Conradi's brilliant-green culture medium, 411.
 Conradi and Drigalski's culture medium, 376, 407.
 Contacts in diphtheria, 246.
 Contagious pneumonia of horses, 456.
 Contaminations, definition of, 76.
 Coplans' medium for diagnosis of diphtheria, 271.
 Copper cylinders for sterilizing pipettes, etc., 4.
 Cornet's forceps, 131.
 Corpuseles of Cornalia, 752.
 Correction of lenses for achromatism, 115.
 Corrosive sublimate as hardening agent, 189.
Corynebacteria, characteristics of, 245 footnote.
Corynebacterium diphtheriæ, 245 footnote.
 — *commune*, 245 footnote.
 — *conjunctivæ*, 245 footnote.
 — *mallei*, 245 footnote.
 Courbevoie vibrio, 491, 492.
 Cover-glasses, effect of thick, 119.
 — cleaning of, 130.

- Cows, contagious mammitis of, 613.
 — diphtheria in, 246.
 — tuberculosis in, 290, 294.
- Cow-pox, virus of, 840.
- Crescent parasites in malaria, 775.
- Cresoidin solution, 253.
- Croup, 245.
 — diagnosis of, 269.
- Cryptococcus*, 701 footnote.
 — *degenerans*, 707.
 — *dermatitis*, 706.
 — *farcinosus*, 706.
 — *gilchristi*, 706.
 — *hominis*, 706.
 — *linguæ pilosæ*, 706.
 — *lithogenes*, 706.
 — *tokishigei*, 707.
- Ctenocephalus canis* on rats, 461.
- Ctenopsyllus musculi* on rats, 461.
- Culex pipiens*, 782.
- Cultivation of aërobic micro-organisms, 67.
 — anaërobic micro-organisms, 92.
 — micro-organisms (see the several chapter headings).
 — on special media for isolation, 85.
- Cultural characteristics of micro-organisms (see the several chapter headings).
- Culture media, agar, 42.
 — of animal tissues and fluids, 30.
 — gelatin, 39.
 — liquid, 30.
 — litmus, 56.
 — meat, 54.
 — rabbit-blood broth, 584.
 — solid, 39.
 — synthetic, 38.
 — vegetable, 37, 55.
 — removal of air from, 87.
 — sterilization of, 9.
 — — by filtration, 18.
 — tray for sloping, 52.
 — tubes, sealing of, 30.
 — vessels, 29.
- Cultures, macroscopical characteristics of, 73.
 — examination of, 73.
 — — microscopically, 130.
 — inoculation of, 169, 170.
 — isolation of organisms by stroke, 81.
 — methods of storing, 75.
 — pure, 76.
- Cupping, 193.
- Curtis' stain (*Sacch. tumefaciens*), 705.
- Cuti-reaction, von Pirquet's (Tuberculosis), 327.
- Cyclospora*, 766.
- Cyprinodont fish, Microsporidia in, 754.
- Cystomonas urinaria*, 827.
- Cystospermium villorum intestinalium canis*, 764.
- Cytase, 229.
- Cytotoxins, 353.
- Czermak's apparatus for holding animals, 161.
- Danilewsky*, 783.
 — *lacazei*, 785.
- Danzysz's virus, 444.
- Dark-ground illumination, 123.
- Davidson's stain (*T. pallidum*), 729.
- Dean's (G.) diphtheria toxin, 259.
- Dean's (H. R.) technique for complement fixation reaction, 428.
- Debove's syringe, 167.
- Debrand's apparatus for holding animals, 161.
 — forceps, 131.
- Defibrination of blood, 36.
- "Definition" of lenses, 114.
- Demandre's method of controlling temperatures of sterilization, 12.
- Delhi boil, 802.
- Deneke's vibrio, 503.
- Dental caries, culture medium for, 41.
- Dermacentor occidentalis*, 802.
- Dermatitis coccidioides, 706.
- Detection of micro-organisms (see the several chapter headings).
- Deviation of complement, 232.
- Dhobie itch, 688.
- Diagnosis of glanders with mallein, 484.
 — tuberculosis with tuberculin, 325.
- Diaphragms for dark-ground illumination, 127.
- Differential staining of films (gram-positive organisms), 207.
 — — (gram-negative organisms), 209.
- Differentiation of types of tubercle bacilli by cultivation, 320.
- Diphtheria antitoxin, 265.
 — bacillus, 245.
 — — non-virulent, 255.
 — — relationship to Hofmann's bacillus, 274.
 — — summary of diagnostic tests, 273.
 — contacts, 246.
 — convalescents, duration of infectivity 246.
 — toxin, 257.
 — — unit of, 260.
 — Bird, virus of, 842.
- Diphtheroid organisms in leprosy, 351.
- Diplococcus crassus*, 626.
 — *intracellularis meningitidis*, 644.
- Diacomyces*, 655.
 — *alba*, 661.
 — *asteroides*, 660, 662.
 — *bovis*, 656, 661.
 — *brasiliensis*, 665.
 — *capræ*, 668.
 — *farcinicus*, 667.
 — *flava*, 661.
 — *försteri*, 662.
 — *freeri*, 664.
 — *garteni*, 660, 661.
 — *hofmanni*, 669.
 — *israëli*, 661.
 — *liquefaciens*, 660, 661
 — *maduræ*, 662.
 — *minutissimus*, 666.
 — *rosenbachi*, 662.
 — *spitzi*, 661.
 — *thibiergi*, 661.

- Discomyces*, polychrome, 669.
 Dispersive power of lenses, 114.
 Displacement of air from culture media, 88.
 Dissemination, isolation by, 77.
 Distemper, bacillus of, 457.
 — — (M'Gowan's), 459.
 — filtrable virus in, 457, 842.
 Distortion of microscopical image, 109.
 Dogs as experimental animals, 157.
 — bleeding of, 195.
 — handling of, 163.
 — inoculation into biliary passages, 177.
 — intra-cranial inoculation, 180.
 — intra-spinal inoculation, 181.
 — intra-venous inoculation, 173.
 — oesophageal catheterization of, 182.
 — coccidiosis in, 764.
 — favus in, 692.
 — leishmaniosis in, 801.
 — Nagana in, 811.
 — piroplasmosis in, 791.
 — ringworm in, 687, 688.
 — tuberculosis in, 294.
 Dog-plague, 457.
 Dog-pox, 457.
 Dopter's anti-meningococcal serum, 649.
 Dorset's egg medium, 54, 316.
 Double staining of sections, 219.
 Doulton's white porcelain filtering bougie, 15.
 Dourine, trypanosome of, 809.
 Doyen's coccus, 769.
Drepanidium, 783.
 — *monilis*, 784.
 — *princeps*, 784.
 — *ranarum*, 784.
 Dried fruits as culture media, 38.
 Drigalski's spatula, 407.
 Dromedaries and El Debab (*Tryp. soudanense*), 813.
 — Mbori (*Tryp. soudanense*), 813.
 Drum-stick bacilli, 549.
 Duck cholera, 452.
 — pasteurellosis, 448.
 Duclaux's filter, 25.
 — method for collecting milk, 201.
 Ducretet and Lejeune's autoclave, 11.
 Ducrey's bacillus, 513.
 Dum dum fever, 797 footnote.
 Dunbar's method for diagnosing cholera, 501.
 Dunschmann's medium for isolation of the typhoid bacillus, 410.
 — method for isolation of the typhoid bacillus from blood, 392.
 — — for preparation of toxin of quarter ill, 558.
 — serum for quarter ill, 559.
 Duval's media for the leprosy bacillus, 352.
 Dyes, aniline (*see* Stains).
 Dysentery, amœbæ in, 746.
 — trichomonas in, 825.
 — serum diagnosis of, 364.
 — serum therapy of, 361.
 — vaccination against, 362.
 — bacillus, 356.
 Dysentery, amœbæ in, El Tor, 365.
 — — classification of, 357, 360.
 Dysgonic tubercle bacilli, 314.
 East African relapsing fever, 712.
 East Coast fever of cattle, 793.
 Echinococcus infection in cattle, Tuberculin in, 326.
 Eczema marginatum, 688.
 Egg as a culture medium, 53, 316, 317.
 Egg-albumin (powdered), 639.
 Ehrlich's aniline-violet, 139.
 — method of standardizing antitoxin, 268.
 — stain for tubercle bacilli, 308, 311.
 — theory of bacteriolysis, 229.
 Ehrlich-Biondi stain, 768 footnote.
Eimeria, 764.
 — *hominis*, 764.
 El Debab, 813.
 El Tabardillo, 847.
 El Tor bacillus, 365.
 Eleidine, 766.
 Elephants and Surra, 814.
 Ellermann and Erlandsen's method for examination of sputum for tubercle bacilli, 339.
 Elmassian's bacillus, 510.
 Elsner's potato gelatin, 41.
 — method for isolating the typhoid bacillus, 85, 403.
 Embedding methods, 212.
 Endo's agar, 408.
Endodermophyton concentricum, 687.
 — *indicum*, 688.
 Endolysins, 223.
Endomyces, 701 footnote.
 — *albicans*, 702.
 Endospore, 145.
 Endotoxin, cholera, 495.
 — dysentery, 361.
 — plague, 467.
 — typhoid (Besredka's), 379.
Entamoeba coli, 747.
 — *histolytica*, 747.
 Enteric fever, 366.
 — — serum diagnosis of, 384.
 — — and flies, 367.
 Enterococcus, 627.
 Enumeration of organisms in water, 853.
 Eosin, alcoholic solution, 209.
 — aqueous solution, 207, 218.
 Epidemic cerebro-spinal meningitis, 644.
 — — — (pneumococcal), 581.
Epidermophyton cruris, 688.
 — *gallinæ*, 692.
 — *inguinale*, 688.
 Epilation of hair, 170.
 Epizootic lymphangitis, 706.
 Epizootics (spontaneous) among laboratory animals, 159.
 — — due to anthrax, 518.
 — — — *B. typhi murium*, 444.
 — — — filter passing organisms, 160, 835 *et seq.*
 — — — Gaertner's bacillus, 442.
 — — — Microsporidia, 752.

- Epizootics (spontaneous) due to *Pasteurella* group, 446 *et seq.*
 — — — Plague bacillus, 460.
 — (experimental) among ground squirrels, 448.
- Eppendorf's whooping cough bacillus, 570.
 Eppinger's streptothrix, 662.
 Epstein's stain for diphtheria, 253.
 Equidæ and Mal de Caderas, 814.
 Equine herpes, 687, 689.
 — *pasteurella*, 456.
 — *piroplasmosis*, 792.
 — *tuberculosis*, 296.
- Ericolin, 352.
 Erlenmeyer flask, 29.
 van Ermengem's stain for flagella, 149.
 Ernst-Neisser stain for diphtheria, 252.
 Erysipelas, 592.
 Erysipèle, 283 footnote.
 Erysipelococcus, 593.
 Erythrasma, 666.
 Esmarch's tubes, 103.
 — roll tubes, 81.
- Espundia, 802.
 Ether as an antiseptic, 27.
 — method for embedding, 215.
 — temperature regulators, 59.
- Eugonic tubercle bacillus, 314.
 European relapsing fever, 712.
 Ewes, gangrenous mammitis of, 615.
- Examination (macroscopical) of cultures, 73.
 — — of stained preparations, 135.
 — — of unstained preparations, 131.
 — (bacteriological) of fluids and tissues, 203.
- Excreta (*see* Stools).
 Exudates, inoculation of, 169.
Exoascidæ, 701 footnote.
- Experimental animals, spontaneous diseases of, 159.
 — inoculation (*see* the several chapter headings).
- Eye, inoculation into anterior chamber of, 178.
 Eye pieces, 120.
 — compensating, 115.
 — Huygenian, 116.
 — Ramsden, 122.
- Eyre's method for neutralization of culture media, 31.
- Facultative anaerobes, 87.
 Faeces (*see* Stools).
 False membrane, collection of, 197, 270.
 — — produced by toxin, 261.
 — spores, 526.
- Farcy, 480.
 — buds, 480.
 — Japan, 707.
- Fasoti's stain (Negri bodies), 841.
 Favus, 690.
 — in the lower animals, 692.
- Fehleisen's *Streptococcus erysipelatos*, 593, 596.
 Femoral artery, inoculation into, 173.
 Fernbach flask, 253.
- Ferran's cholera vaccine, 496.
 Ferret septicæmia, bacillus of, 453.
 Ferrets and plague, 461.
- Ficker's methods for the isolation of the typhoid bacillus, 406, 409.
 — *typhus diagnosticum*, 388.
- Film preparations, 203.
 — — staining of, 204.
 — — differential staining of, 207.
 — — — — for gram-negative organisms, 210.
- Filters, 14.
 — for small quantities of fluids, 24.
 — collodion sacs as, 175.
- Filtrable viruses, 835.
 — — and dark-ground illumination, 124.
 — — as causes of epizootics, 160, 439, 835 *et seq.*
- Filtration by aspiration, 19.
 — compression, 18.
 — of agar, Fischer's method, 44.
 — — Karlinski's method, 44.
 — carbohydrate media, 35.
 — culture media, 18.
 — serum, 47.
 — — (Miquel's apparatus), 48.
 — small quantities of fluid, 24.
 — spirochetes, 713.
 — *Treponema pallidum*, 737.
 — water, 15.
- Finkler-Prior vibrio, 502.
 Fischer's method for filtration of agar, 44.
 — gelatin, 41.
- Fish, Microsporidia in, 754.
 — Myxosporidia in, 756.
 — Trypanosomes in, 824.
 — Tuberculosis in, 296.
- Fixateur, 229.
 Fixation of films, 205.
 — complement, 232.
- Fixative, albumin (Mayer's), 215.
 — Borrel's for sporozoa in sections, 761.
 — Pianese's for coccidia, 761.
 — Schaudinn's, 749.
- Fixing reagents for tissues, 188.
 Flagellata, 803.
 Flagellated malarial parasite, 775.
 Flagellum staining, 148.
 Flaschen bacillen of Unna, 693.
 Flatness of image, 115.
 Fleig's test for indol, 374.
- Flemming's solution as hardening agent, 189.
 — perchloride as hardening agent, 190.
- Flexner's dysentery bacillus, 357.
 — antimeningococcal serum, 648.
- Fleas and Dourine, 809.
 — Plague, 461.
 — Trypanosomiasis, 805.
- Flies and Anterior poliomyelitis, 846.
 — Enteric fever, 367.
 — equine Piroplasmosis, 792.
 — Galziette, 816.
 — Kala azar, 800.
 — Oriental sore, 802.
 — Plague, 462.

- Flies and Surra, 814.
 Fluids, bacteriological examination of, 203.
 Fluorescein, aqueous solution, 218.
 "Fly disease," 813.
 Foa's differential stain for sections, 220.
 Focal length of lenses and magnification, 120.
 Food poisoning, 438.
 — (Aertrycke bacillus), 438.
 — (*B. botulinus*), 549.
 — (Gaertner bacillus), 442.
 — (Paratyphoid *B. bacillus*), 432.
 Food stuffs and plague, 462.
 Foot and mouth disease, virus of, 838.
 Forceps, Cornet's, 131.
 — Debrand's, 131.
 — Liston's, 187.
 Formalin as an antiseptic, 26.
 — hardening agent, 189.
 Fowls, epizootic among (*Pasteurella gallinæ*), 447.
 — (*Vib. metchnikowi*), 503.
 — favus in, 692.
 — ringworm in, 687.
 — spirochætosis in, 718.
 — and plague, 461.
 Fowl cholera, bacillus of, 447.
 — plague, 447.
 — septicæmia, 447.
 — typhoid, 447.
 Fractional cultivation, 84.
 Fränkel's stain (Tubercle bacilli), 309.
 — method for isolating anaërobes, 103.
 Frambæsia, 736.
 Frankland's method for examination of air, 865.
 Freezing methods for cutting sections, 212.
 Friedberger's *B. hæmoglobinophilus canis*, 510.
 Friedberger and Moreschi's antityphoid vaccination, 381.
 Friedländer's bacillus, 415.
 — stain (*Pneumococcus*), 584.
 Frogs as experimental animals, 157.
 — feeding of (Ledoux-Lebard), 158.
 — keeping of, 158.
 — inoculation of, 171.
 — Trypanosomes in, 824.
 Fruits as culture media, 38.
 Fuchsin ink, 150.
 Furnace, muffle, 17.
 Furunculosis, 617.
Fuscus crispus, 746.
 Gabbe's stain (Tubercle bacilli), 308.
 Gaertner's bacillus, 442.
 Gall sickness, 816.
 Galziente, 816.
 Gamaléia's cholera toxins, 495.
 Gangrene, anaërobic organisms in, 569.
 — gaseous, 561.
 Garlic, essence of, as an antiseptic, 27.
 Garotilho, 517.
 Garros' filtering bougie, 15.
 Gases, sterilization of, 89.
 Gasser's culture medium, 57.
 Gastro-enteritis of dogs, 457.
 Gathgens' method for the isolation of the typhoid bacillus, 409.
 Geese, epizootics among (*Past. gallinæ*), 448.
 — osteo-myelitis in, 618, 619.
 — spirochætosis in, 717.
 — and Plague, 461.
 Gelatin culture media, 39.
 — types of growth in, 74.
 — — liquefaction, 74.
 — agar, 43.
 — litmus, 57.
 — glucose-litmus, 57.
 — lactose-litmus, 57.
 — mannite-litmus, 57.
 — raisin, 41.
 Gemelli's stain for flagella, 153.
 German plague Commission vaccine, 469.
 Giblet broth, 32.
 Giemsa's solution, 727 footnote, 774.
 Giocelli's placenta medium (Tubercle bacillus), 318.
 Glanders bacillus, 480.
 — latent, 485.
 Glass for lenses, 114, 116.
 Glass needles for sowing cultures, 70.
Glossina morsitans and Nagana, 811.
 — — and Sleeping Sickness, 820, 821.
 — *palpalis* and Nagana, 811.
 — — and Sleeping Sickness, 820.
 Glosso-anthrax, 518.
 Glucose for absorbing oxygen, 89.
 — in cultivation of anaërobes, 99.
 — glycerin-agar, 44.
 — glycerin-gelatin, 664.
Glugea bombycis, 752.
 Glycerin-agar, 44, 693.
 — -broth, 35.
 — -fish-broth (Tubercle bacillus), 319.
 — -potato, 55.
 — — for tubercle bacilli, 320.
 — -serum, 53.
 Goats as experimental animals, 156.
 — Mediterranean fever in, 475.
 — Pasteurellosis in, 456.
 — Sarcosporidiosis in, 758.
 — Tuberculosis in, 295.
 Golaz's wax, 53.
 Gonococcus, 634.
 — and Meningococcus, similarities between, 645.
 — blood-broth for, 34.
 Gonotoxin, 640.
Gonospora longissima, 794.
 Gordon's medium (differentiation streptococci), 35.
 — metabolic tests, 601.
 Gorsline's collodion sacs, 176.
 Gosio's plague vaccine, 469.
 "Gout" in swine, 283, 286.
 Gram's solution, 143.
 — stain, 142.
 — — for films, 207.
 — — for typhoid bacilli in sections, 217.
 "Grapes," 294.
 Grasbazillus, 345.

- Grassi's solution, 748.
 Grassberger and Schattenfroh's serum (quarter ill), 560.
Gregarina blattarum, 796.
Gregarinida, 794.
 Griffith's (A. S.) egg medium (Tubercle bacillus), 317.
 — — glycerin-potato (Tubercle bacillus), 321.
 — — method isolation tubercle bacilli from sputum, 341.
 — (A. S. and F.), immunization of cattle, 331.
 Grijns' agar for *A. fumigatus*, 697.
 Grimbert's medium for fermentation reactions, 417.
 — — isolation of typhoid bacillus, 404.
 Grimbert and Legros' medium, 373.
 Ground squirrels as experimental animals, 157.
 — epizootics among (*B. typhi murium*), 444.
 — extermination of, 448.
 — natural plague in, 461.
 — Trypanosomes in, 808.
 Grünbaum-Widal reaction, 384.
 Group-agglutinins (see Co-agglutinins).
 Guéniot's placenta medium, 54.
 Guinea fowl, epizootics among (*Past. gallinæ*), 447.
 Guinea-pigs as experimental animals, 156.
 — collection of blood from, 194.
 — epizootics among (Gaertner's bacillus), 442.
 — — — (filter-passing organisms), 439.
 — — — (infectious pneumonia), 457.
 — — — (spontaneous plague), 460.
 — handling of, 162.
 — inoculation into biliary passages, 177.
 — intra-cranial inoculation, 180.
 — œsophageal catheterization, 181.
 — intra-spinal inoculation, 181.
 — intra-venous inoculation, 172.
 — Trypanosomes in, 808.
 Gummata, multiple disseminated, 672.
 Gunther's stain (Spirochætes), 715.
Gymnoascidæ, 679.
Hæmacytozoa, 770.
Hæmameba, 770.
 — *danilewskyi*, 782.
 — *kochi*, 781.
 — *majoris*, 782.
 — *malariae*, 770.
 — var. *parva*, 780.
 — — — *tertiana*, 780.
 — — — *quartana*, 780.
 — *melaniphæra*, 781.
 — *relicta*, 782.
 — *ziemanni*, 782.
Hæmaphysalis leachi and *Piroplasma canis*, 791.
 — *punctata* and *Piroplasma bigeminum*, 787.
 Hæmatein solution, 218.
Hæmatococcus, 786 footnote.
Hæmatopinus spinulosus and *Trypanosoma lewisi*, 805.
 Hæmatoxylin, Bøhmer's, 218.
 Hæmatozoa, 770.
 — of birds, 781.
 — of malaria, 778.
 Hæmatozoon of bats, 781.
 — monkeys, 781.
 Hæmoglobin for blood-broth, 34.
 — blood-agar, 53.
Hæmogregarina, 783.
 — *lacertarum*, 785.
 — *ranarum*, 784.
 — *stepanovi*, 783.
 Hæmolyisin, streptococcal, 603.
 Hæmolyisins, 230.
 Hæmolyso-diagnosis, 238.
 Hæmolytic couple, 232.
 Hæmolytic serum, titration of, 234.
 Hæmorrhagic septicæmias, bacilli of the, 421, 446.
 Haffkine's cholera vaccine, 497.
 — plague vaccine, 468.
 Hagemann's agar, 408.
 Hair, collection of, for bacteriological examination, 191.
 — epilation of, 170.
Halleridium, 770.
 — *danilewskyi*, 782.
 Handling of experimental animals, 160.
 Hanging-drop preparations, 132.
 Hansen's bacillus, 348.
Haplosporidia, 759.
 Hardening reagents for tissues (see Fixatives), 188.
 Haricot decoction medium, 37.
 Hay infusion medium, 37.
 Heart-water, 839.
 Heat as an auxiliary to staining, 137.
 — fixation of films by, 205.
 — resistance of bacteria to, 7.
 — — spores to, 8.
 — sterilization by discontinuous, 8, 12.
 — — dry, 4.
 — — moist, 7.
 Hecht and Wilenko's stain (*T. pallidum*), 728.
 Hectic fever, 297.
 Heiman's agar, 639.
 Heinemann's jelly, 56.
Helcosoma tropicum, 802.
 Hereditary infection in *Nosema apis*, 754.
 — — — *bombycis*, 753.
 — — lice (spirochætosis), 712.
 — — ticks (spirochætosis), 712.
 — — — (piroplasmosis), 787, 791.
 Herman's stain (Tubercle bacilli), 309, 311.
Herpetomonas, 804.
 — *lewisi*, 805 footnote.
 — *muscæ domesticæ*, 805 footnote.
 Herxheimer's stain (*T. pallidum*), 729.
 Herxheimer and Huber's stain (*T. pallidum*), 729.
 Hesse's albumose agar (tubercle bacilli), 317.
 — peptone agar, 410.

- Hesse's method (Examination of air), 863.
 — — (Cultivation of tubercle bacilli from sputum), 340.
 — tube, 863.
- Heterologous agglutinins (*see* Co-agglutinins).
- Heyden's albumose, 340.
- Hippoboscidae* and *Trypanosoma theileri*, 816.
- Hiss' serum-water medium, 585.
 — stain for capsules, 148.
 — classification of dysentery bacilli, 360.
 — Y bacillus, 360, 363.
- Histological examination, removal of tissues for, 188.
 — preparations (*see* Sections), 211.
 — — (freezing methods), 212.
 — — (paraffin embedding), 212.
 — — simple staining of, 216.
 — — differential staining of, 216.
- Hofmann's bacillus, 273.
- Hoffmann and Halle's stain (*T. pallidum*), 729.
- Hog cholera, 439.
 — — virus of, 843.
 — — and swine plague, 454.
 — — and swine erysipelas, 288.
- Hollow ground slides, 132.
 — — — cultivation in, 134.
- Homologous agglutinins (*see* Agglutinins).
- Horse plasma (Jousset's), 342.
 — serum and anaphylaxis, 224.
 — sickness, virus of, 838.
 — syphilis, 809.
 — typhoid, 456.
- Horses as experimental animals, 156.
 — collection of blood from, 48, 193.
 — handling of, 164.
 — intra-venous inoculation of, 173.
 — anthrax in, 518.
 — piroplasmiasis in, 792.
 — ringworm in, 687.
 — spirochætosis in, 719.
 — tetanus in, 536.
 — trypanosomiasis in, 809, 811, 813, 814.
 — tuberculosis in, 296.
- Hospital gangrene, 574.
- Hot water funnel, 40.
- Hot air sterilizers, 5.
- Houses for experimental animals, 157.
- Houston's method of water examination, 858.
- Huber's hæmoglobin-agar, 507.
- Hueppe and Scholl's cholera toxin, 495.
- Human serum therapy (*see* Serum therapy).
 — tubercle bacillus, 289.
 — tuberculosis, 292.
 — vaccine therapy (*see* Vaccine therapy).
- Huygenian eyepiece, 116.
 — — not suitable for measuring objects, 122.
- Hyalomma aegyptium* and Bovine farcy, 667.
- Hydrochloric acid solution, 210.
- Hydrogen, generation of, 88.
 — — (in cultivation of anaërobes), 88, 89.
- Hydrophobia, virus of, 841.
- Hyperimmunization, 222.
- Hypomycetes, 655.
- Iceland moss as substitute for agar, 44.
- Ichthic tubercle bacillus, 292, 296.
- Identification of antibodies by complement-fixation, 238.
 — — organisms (*see* the several chapter headings).
 — — by complement-fixation, 237, 437.
- Idiopathic tetanus, 536.
 I.E., 268.
- Ilkewitsch's method for examination of sputum (tubercle bacillus), 339.
- Image, brightness of, 112.
 — flatness of, 115.
 — sharpness of, 114.
- Immune body, 228.
- Immunity, 221.
 — acquired, 221.
 — crossed, in spirochæte infections, 717.
 — mechanism of, 222.
 — natural, 221.
 — passive, 222.
- Immunization (*see* Vaccination).
- Inactivated serum, 234.
- Incinerator, 17.
- Incubators, 58.
 — opsonic, 240.
 — vacuum, 104.
- Incubator rooms, 59.
- India-rubber apparatus, sterilization of, 9.
 — caps, 29.
- Indian kala azar, 797.
 — — — compared with Mediterranean, 800.
 — — relapsing fever, 712.
- Indiella*, 665 footnote.
 — *mansoni*, 665.
 — *reymieri*, 665.
 — *somaliensis*, 665.
- Indigo white, 88, 92.
 — — a test for oxygen, 92.
- Indol, medium for production of, 374.
 — tests for, 374.
- Infantile diarrhœa, 356.
 — kala azar, 800.
 — paralysis, 844.
 — splenic anæmia, 800.
- Infection by feeding, 181.
 — ingestion, 181.
 — inhalation, 180.
- "Infectious epithelioses," 840.
- Infectious pneumonia of dogs, 457.
 — — goats, 456.
- Influenza bacillus, 504.
 — of horses, 456.
- Infusoria*, 829.
- Infusorial earth filters, 15.
- Ingestion, infection by, 181.
- Inhalation, infection by, 180.
 — theory of tuberculosis, 292.

- Inoculated animals, observations upon, 182.
- Inoculation of animals, 156.
- general rules for, 170.
 - preparation of material for, 169.
 - apparatus for, of large quantities of fluid, 168.
 - instruments for, 165.
 - of mucous surfaces, 171.
 - needles, 168.
 - Pasteur pipettes for, 166.
 - subcutaneous, 171.
 - syringes, 166.
 - into intestines, 182.
 - — lymph spaces, 171.
- Instruments used for inoculation, 165.
- — *post mortem* examinations, 184.
 - — sowing cultures, 67.
- Internal organs as culture media, 54.
- Intestinal amœbæ, 746.
- anthrax, 517.
- Intra-arterial inoculation, 173.
- Intra-cerebral — 181.
- Intra-cranial — 180.
- Intra-dermal — 171.
- Intra-muscular — 172.
- Intra-peritoneal — 174.
- Intra-pleural — 179.
- Intra-pulmonary — 179.
- Intra-spinal — 181.
- Intra-tracheal — 179.
- Intra-venous — 172.
- Intra-dermo reaction (Tuberculosis), 327.
- Inocopy, 342.
- Invisible micro-organisms, 835.
- Iodine solution (Gram's), 143.
- — (Merieux's), 209.
 - — (Nicolle's), 209.
- Irregular malarial fever, 780.
- Isle of Wight bee disease, 752.
- Isolation of aerobic micro-organisms, 76.
- anaërobic micro-organisms, 101.
- Issaëff's pneumococcus toxin, 587.
- Izodes ricinus* and *Piroplasma bigeminum*, 787.
- Izodioplasma*, 786 footnote.
- Jackson and Melia's method of isolating the typhoid bacillus, 410.
- Jæger-Heubner coccus, 626.
- Jatta and Maggiora's plague vaccine, 469.
- Jamamoto's stain (Leprosy bacillus), 350.
- Japan farcy, 707.
- Jena flasks, 29.
- Jenner's stain, 773.
- Jockmann's method of cultivating the tubercle bacillus from sputum, 340.
- Jousset's methods of detecting the tubercle bacillus, 340, 342, 344.
- Jugular vein, inoculation into, 173.
- Jurewitch's potato medium for the tubercle bacillus, 320.
- Kala azar, Indian, 797.
- — infantile, 800.
 - — Mediterranean, 800.
- Kangaroo, Sarcosporidia in the, 758.
- Karlinaki's filter for agar, 44.
- Kayser's method for isolating the typhoid bacillus from blood, 392.
- Keeping of animals, 157.
- Kitasato's dish, 101.
- filter, 25.
 - method for collecting sputum, 192.
 - — cultivating anaërobic, 99.
 - — — tubercle bacilli from sputum, 340.
 - — isolating anaërobic, 101.
 - — vaccinating against quarter ill, 557.
- Kidney, inoculation into, 178.
- Kitt's quarter ill serum, 559.
- Klausner's serum diagnosis of Syphilis, 741.
- Klebs-Lœffler bacillus, 245.
- Klingmueller's phenomenon, 327.
- Klemperec's pneumococcus toxin, 586.
- Klossia helicina*, 765.
- Koch's bacillus of mouse septicæmia, 288.
- drying stage, 141.
 - hollow-ground slide, 132.
 - method for collecting serum, 46.
 - — examination of air, 863.
 - — isolation of aërobic, 77, 79, 85.
 - old tuberculin, 324.
 - peptone solution, 33.
 - serum coagulator, 51.
 - stain (Tubercle bacilli), 310.
 - steamer, 8.
 - vibrio, 488.
- Kolle's cholera vaccine, 497.
- Kolle and Otto's plague vaccine, 469.
- Král's agar for gonococcus, 639.
- Krauss and Dœrr's dysentery serum, 362.
- Krawkoff's cholera toxin, 495.
- Kühne's alkaline blue, 139.
- carbol-methylene-blue, 138.
 - differential stain for films, 210.
 - — — sections, 219.
 - simple stain for sections, 216.
 - stain (Tubercle bacilli), 310.
- Kurth's *Streptococcus conglomeratus*, 596.
- La bactérie ovoïde, 446.
- "Laboratory animals," 156.
- spontaneous diseases of, 159.
- La clavelée, 839.
- Lacomme's tube (cultivation of anaërobic), 93.
- Lafforgue's method (isolation of typhoid bacillus from blood), 391.
- Lambliæ intestinalis*, 827.
- Lankesteria acidia*, 796.
- La poliomyélite épidémique, 844.
- Largine for staining *Treponema pallidum*, 728.
- Latapie's apparatus for bleeding large animals, 50.
- — — small animals, 196.
- Laveran's method (bacteriological examination of air), 867.
- blood stain, 210.
 - stain (Malaria), 772, 773.

- Laveran and Pettit's culture medium (*Leishmania donovani*), 799.
- Laverania malariae*, 770, 780.
- Le Dantec's method of examining blood (Malaria), 772.
- Leclainche's malignant œdema serum, 568.
- Leclainche and Vallée's quarter ill serum, 559.
- — malignant œdema vaccines, 565, 568.
- — quarter ill vaccines, 557-8.
- Ledoux-Lebard's method of feeding frogs, 158.
- "Leeches," 674.
- Leeches as intermediate hosts of hæmogregarines, 784.
- — — *H. ranarum*, 785.
- Legerella*, 766.
- Legros' method for cultivating anaërobes, 97.
- Leipschutz's agar (*Gonococcus*), 639.
- Leishman's stain, 773.
- Leishman-Donovan body, 797.
- Leishmania donovani*, 797.
- *furunculosa*, 802.
- *infantum*, 800.
- *tropica*, 802.
- — var. *americana*, 802.
- Leishmaniosis in cats, 802.
- dogs, 801.
- Lemco, 34.
- Lemière and Bécue's stain (Actinomycosis), 658.
- Lenses, apochromatic, 115.
- correction of, 115.
- definition of, 114.
- homogeneous immersion, 119.
- penetrating power of, 114.
- resolving power of, 114.
- methods of testing definition of, 114.
- Lepidophyton concentricum*, 700.
- Lepidoptera, microsporidia in, 754.
- Lépine and Lyonnet's typhoid toxin, 376.
- Lepra cells, 354.
- Leprosy bacillus, 306, 348.
- and tuberculosis, simultaneous infection with, 355.
- Leptotheca agilis*, 756.
- Lesage's method for cultivation of amœbæ, 750.
- Letulle's stain (Tubercle bacilli), 311.
- Leuch's method for isolation of the typhoid bacillus, 409.
- Leuckart's moulds for paraffin embedding, 214.
- Leucocidine, 623.
- Leucocytozoon canis*, 783.
- Leucotoxin in treatment of leprosy, 354.
- Leukins, 223.
- Levaditi's pipettes, 234.
- Levaditi's stain (*T. pallidum*), 731.
- Levaditi and Manouélian's stain (*T. pallidum*), 731.
- Liborius' agar for anaërobic cultivation, 99.
- Liborius and Veillon's method of isolating anaërobes, 103.
- Lice and spirochætosis, 711.
- trypanosomiasis, 805.
- typhus, 848.
- Lichen crispus*, an agar substitute, 44.
- Lichtheimia corymbifera*, 677.
- *racemosa*, 677.
- Liebig's broth, 34.
- gelatin, 41.
- Life history of *Coccidium cuniculi*, 762.
- — *Gregarinida*, 794.
- — *Leishmania donovani*, 799.
- — malarial parasite, 776.
- — *Nosema apis*, 754.
- — *bombycis*, 752.
- — *Piroplasma bigeminum*, 788.
- — *canis*, 792.
- — *Sarcosporidia*, 757.
- — *Trypanosoma cruzi*, 822.
- Lignières' polyvalent vaccine (pasteurelloses), 459.
- von Lingelsheim's *Streptococcus brevis*, 596.
- — *longus*, 596.
- Liquefaction of gelatin, types of, 74.
- Liquid culture media, 30.
- Lister's method of isolating organisms, 76.
- Liston's forceps, 187.
- Lithia solution (Kühne's), 210.
- Litmus as an indicator, 31, 56.
- solution, preparation of, 56.
- Lœffler's aniline-fuchsin, 483.
- methylene blue, 139.
- serum, 52.
- — for diphtheria, 271.
- bile medium for isolation of the typhoid bacillus, 410.
- malachite-green for isolation of the typhoid bacillus, 410.
- stain for flagella, 149.
- — sections, 216.
- Lophophyton gallinae*, 692.
- Lorrain Smith's medium (diphtheria bacillus), 271.
- Löwenberg's bacillus, 419.
- Lubénau's egg medium, 54.
- caffeine-agar (typhoid bacillus), 409.
- Lugol's solution as a mordant, 143.
- Lumbar puncture, 199.
- Lumière's bleeding apparatus, 196.
- (A. and L.) tissue culture media (tubercle bacillus), 318.
- Lung, inoculation into, 179.
- Lupus, characteristics of bacilli in, 290, 293.
- Lustgarten's stain (Tubercle bacilli), 310, 311.
- "Syphilis bacillus," 346.
- Lustig and Galeotti's plague vaccine, 470.
- Lycoperdon spores, 180.
- Lycopodium powder, 180.
- Lymph spaces, inoculation into, 171.
- Lymphatic glands, removal of, for bacteriological examination, 198.
- Lysol as an antiseptic, 26.
- μ as a unit of measurement, 122.
- MacConkey's media (typhoid-colon group), 85, 412.

- Macfadyen and Rowland's typhoid toxin, 379.
- M'Gowan's bacillus of distemper, 459.
- Madura foot, 662.
— — parasites of, 665.
- Madurella* (genus), 665 footnote.
- Magnification, limits of effective, 113.
— measurement of, 122.
— produced by a microscope, 107.
- Mal de brou, 787.
— de Caderas, 814.
— du coit, 809.
— de la Zousfana, 813.
- Malachite green media, 375, 409.
- Maladie de Heine-Médin, 844.
- Malarial fevers, types of, 780.
- Malassez's syringe, 167.
— warm stage for microscope, 135.
- Malassezia furfur*, 669.
— *macfadyeni*, 670.
— *mansonii*, 670.
— *tropica*, 670.
- Malignant jaundice of dogs, 791.
— cedema, vaccine for, 565.
— pustule, 517.
- Malignes Ödem, 561.
- Mallein, 484.
— in diagnosis of glanders, 484.
— and tuberculin, similarity of effects of, 325.
- Mallory and Wright's stain (Amcæbæ), 749.
- Malm's agar, 44.
- Malt extract medium, 37.
- Malta fever, 475.
- Malta vibrio, 492.
- Mammalia, *post mortem* examination of, 187.
- Mammary tuberculosis in cows, 294.
- Mammitis of cows, streptococcus of, 613.
— ewes, micrococcus of, 615.
- Manchuria, epidemic plague in, 462.
— treatment of dysentery in, 362.
- Mannite-fermenting dysentery bacilli, 357.
- Manure bacillus, 345.
- Maragliano's antituberculous serum, 334.
— tuberculin, 329.
- Marchoux's antianthrax serum, 531.
— medium for virus of bird plague, 839.
- Marino's method for isolating anaërobes, 102.
— stain (*T. pallidum*), 727.
- Marmier's anthrax toxin, 529.
- Marmorek's phenomenon, 598.
— antistreptococcus serum, 606.
- Marmots and plague, 461, 462.
- Martin's diphtheria toxin, 257.
— glycerin-fish-broth (Tubercle bacillus), 319.
— (E.) filtering apparatus, 25.
— (L.) filtering apparatus, 23.
— peptone broth, 33.
— solution, 32.
- Martini and Lentz's antidysentery serum, 362.
- Massaouah vibrio, 490, 491, 492.
- Massol's diphtheria toxin, 259.
- Mayer's hardening solution, 189.
- Mayer's albumin fixative, 215.
- Mazé's medium for bacteria of plants, 38.
- Mbori, 813.
- Measles, swine, 283.
- Measurement of microscopical objects, 121.
- Meat as a culture medium, 54.
— extract, 32.
- Mechanism of agglutination, 226.
— bacteriolysis, 228.
— hæmolytic, 231.
— immunity, 222.
- Media (*see* Culture media), 28.
- Mediterranean fever, 475.
— kala azar, 800.
- Megastoma entericum*, 827
- Melanin, 774.
- Melanoid mycetoma, 665.
- Meningitis, meningococcal, 644.
- Meningococcus, 644.
— and gonococcus compared, 645.
— blood-broth medium for, 34.
- Meningococcal meningitis, 644.
- Mentagra, 686.
- Mercury oxycyanide as antiseptic, 26.
— perchloride as antiseptic, 26.
— as hardening reagent, 189.
— pump, 90.
- Merieux's differential stain for films, 209
— iodine solution, 209.
- Metabolic tests, Gordon's, 601.
- Metal instruments, sterilization of, 4, 9, 26.
- Metchnikoff's method for isolating the cholera vibrio, 85, 501.
— — exterminating ground squirrels, 448.
— peptone-gelatin medium (cholera vibrio), 33.
— vibrio, 503.
- Metchnikoff, Roux and Salimbeni's cholera serum, 499.
— — collodion sacs, 174.
- Methæmoglobinæmia, spontaneous, in rats, 442.
- Methods of abstracting air from culture media, 87.
— controlling the temperature of sterilization, 12.
— examining air, 862.
— — tissues, etc., for micro-organisms (*see* the several chapter headings).
— — water, 853.
— isolating aerobic micro-organisms, 76.
— sowing cultures, 70.
— sterilization, 4.
- Methylene blue-eosin solution (Chenzinsky's), 210.
— — (Romanowsky's), 210.
- Mexican fever, 847.
- Miahle's reaction, 262.
- Mice as experimental animals, 156.
— handling of, 162.
— coccidiosis in, 764.
— epizootics among (*B. typhi murium*), 444.
— favus in, 692.
— Trypanosomes in, 808.

- Micrococcus catarrhalis*, 651.
 — — and influenza, 504.
 — — *fetidus*, 578.
 — — *gazogenes alcalescens*, 578.
 — — *mammilis*, 615.
 — — *melitensis*, 475.
 — — *neoformans*, 769.
 — — *pelletieri*, 665.
 — — *salivarius pyrogenes*, 617.
 — — *tetragenus*, 631.
 — — — *aureus*, 632.
 — — — *concentricus*, 632.
 — — — *ruber*, 632.
 — — — *septicus*, 632.
 — — — *subflavus*, 632.
 — — — *variabilis*, 632.
- Micrometer, stage, 121.
 — ocular, 122, 123.
- Micromonas mesnili*, 840.
- Micromyces hofmanni*, 669.
- Microscope, 106.
 — care of the, 117.
 — compound, 109.
 — objectives, 107.
 — stand, 106.
- Microscopical appearance of micro-organisms (*see* the several chapter headings).
 — image, aplanatic, 110.
 — objects, measurement of, 121.
- Microsporium audouini*, 688.
 — — var. *canis*, 688.
 — — — *equinum*, 689.
 — — *felineum*, 689.
 — — *furfur*, 689.
 — — *minutissimum*, 666.
- Microsporon mansonii*, 670.
- Microsporidia*, 752.
- Microsporidium apis*, 753.
 — — *bombycis*, 752.
- Microtomes, 211.
- Miescheria*, 756.
- Miescher's tubes, 757.
- Milk as culture medium, 35.
 — — agar for gonococcus, 640.
 — — litmus, 57.
 — — acid fast bacilli in, 338, 345.
 — — antitoxin in, 266.
 — — *B. enteritidis aertrycke* in, 438.
 — — collection of sterile, 35, 201.
 — — goats', and Mediterranean fever, 475.
 — — tubercle bacilli in, detection of, 345.
- Miniopterus schreibersii*, 781.
- Miquel's flask, 29, 852
 — — method of isolating micro-organisms, 76.
 — — — examining air, 866.
 — — — peptone solution, 33.
 — — — serum filter, 48.
 — — — stain for spores, 147.
- Mistbazillus, 345.
- Molluscum contagiosum, 766.
 — — of birds, 842.
- Monas pyophila*, 827.
- Monkeys as experimental animals, 157.
 — — care of, 158.
 — — handling of, 164.
 — — hæmatozoon of, 781.
- Monkeys, spontaneous plague in, 460.
 — — tuberculosis in, 294.
- Monocystis*, 795.
 — — *tenax*, 796.
- Monobromonaphthaline, refractive index of, 119.
- Monovalent serums in streptococcal infections, 606.
- Morel and Dulaus' stain (Actinomycosis), 658.
- Moreschi's typhoid toxin, 378.
- Moro's percutaneous test (Tuberculosis), 328.
- Moser's antistreptococcal serum, 608.
- Mosny's pneumococcal serum, 586.
- Mosquitos, examination of, 780.
 — — and equine piroplasmiasis, 792.
 — — and malaria, 776.
 — — and Mediterranean fever, 476.
 — — and oriental sore, 802.
 — — and plague, 462.
 — — and sleeping sickness, 820.
 — — and yellow fever, 841.
- Moulds, parasitic, 675.
 — — for paraffin embedding, 214.
- Motility of bacteria, 152.
- Morax's bacillus, 511.
- Mordants, 136.
- Mouth sickness, 839.
- Much's stain (Tubercle bacilli), 307.
- Mucor*, 676.
 — — *corymbifer*, 677.
 — — *mucedo*, 676.
 — — *racemosus*, 677.
- Mucoracidae*, 675.
- Mucormycosis, 677.
- Mucous membranes, inoculation of, 171.
- Muffle furnace, 17.
- Muhinyo, 475.
- Muir's stain for flagella, 152.
- Mules, Nagana in, 811.
- Müller's method of isolating the typhoid bacillus, 406.
- Muscardine, 677.
- Musgrave and Clegg's method for cultivating amœbæ, 750.
- Mycetoma, 662.
 — — parasites of, 665.
- Mycotic pityriasis, 670.
- Myxidium danilewskyi*, 756.
 — — *lieberkühni*, 756.
- Myzobolus bütschli*, 756.
 — — *cerebralis*, 756.
 — — *cyprini*, 756.
 — — *lintoni*, 756.
- Myzococcidium stegomyiæ*, 754.
- Myzosporida*, 754.
- N.A., 112.
- Nægeli's medium, 39.
 — — method for isolation of micro-organisms, 76.
- Næggerath and Stachelin's method for examining blood (Syphillis), 733.
- Nagana, trypanosome of, 811.
- Nährstoff Heyden, 317, 340.
- Nastikow's violet, 139.

- Nastikow's agar medium (*Gonococcus*), 639.
 Nattan-Larrier and Bergeron's method of examining blood (*Syphilis*), 733.
 — — — — (*Tuberculosis*), 342.
 Natural immunity, 221.
 Needles, glass, for sowing cultures, 70.
 — for syringes, 168.
 — — (intra-peritoneal inoculation), 174.
 Negri bodies, 841.
 Negro lethargy, 816.
 Neisser's stain (*diphtheria bacillus*), 252.
 — (modified), 252.
 Neisser and Shiga's dysentery endotoxin, 361.
 — — antityphoid vaccine, 382.
 Nencki's test for indol, 374.
 Neutral red as an indicator, 56.
 — — agar, 397.
 — — media, 411.
 Nicolle's carbol-thionin, 138.
 — carbol-gentian-violet, 138.
 — capsule stain, 148.
 — decolorizing solution (*Gram's stain*), 143.
 — iodine solution, 209.
 — mordant (*Gram's stain*), 143.
 — stain (simple) for sections, 217.
 — — (differential) for films, 208.
 — — — sections, 210, 219.
 — — (*Gonococcus*), 637.
 — culture medium (agar-gelatin), 43.
 — — — (*diphtheria toxin*), 260.
 — — (protozoa), 799.
 — and Duclaux's method of cardiac puncture (rabbits), 195.
 — and Morax's stain for flagella, 151.
 — and Weil's medium for leprosy, 353.
 — Nikiforoff's stain (*spirochaetes*), 715.
 Nitrogen in growth of anaerobes, 89.
 Nitroso-indol reaction, 494.
 N.N.N. medium, 799.
 Nocard's glycerin-potato (*Tubercle bacillus*), 320.
 — trocar, 48.
 Nocard and Roux's medium (*Pleuropneumonia of cattle*), 837.
Nocardia actinomyces, 656.
 — *asteroides*, 662.
 — *farcinica*, 667.
 — *försteri*, 662.
 — *hofmanni*, 669.
 — *maduræ*, 662.
 Nøggerath's culture medium, 57.
 Noguchi's medium (*Spirochaetes*), 716.
 — — (*Treponema pallidum*), 737.
 Non-mannite-fermenting dysentery bacilli, 357.
 Non-specificity of complement, 229.
 Normal soda solution, 31 footnote.
Nosema apis, 753.
 — *bombycis*, 752.
 — *bryzoides*, 754.
 — *ovoidium*, 754.
 Novy and MacNeal's medium, 799.
 Numerical aperture, 112.
Nyctotherus faba, 831.
 Objectives, microscope, 107.
 — apochromatic, 115.
 Ochroid mycetoma, 665.
 Oculars, compensating, 115.
 Oesophageal catheterization, 181.
Oidida, 701.
 Oidiomyoosis, 706.
Oidium, 674.
 — *albicans*, 702.
 — *lactis*, 674.
 — *subtile cutis*, 674.
 Onychomycosis, 679, 686.
Oospora asteroides, 662.
 — *bovis*, 656.
 — *canina*, 692.
 — *farcinica*, 667.
 — *försteri*, 662.
 — *hofmanni*, 669.
 — *lingualis*, 706.
 — *maduræ*, 662.
Oosporida, 655.
 Ophthalmic-reaction in tuberculosis, 327.
 Opilação, 822.
 Oppenheim and Sach's stain (*T. pallidum*), 729.
 Opsonic index, determination of, 240.
 Opsonins, 223, 239.
 Optimum temperature, isolation by cultivation at, 84.
 Oriental sore, 802.
Ornithodoros moubata, and Tick fever, 712.
 — — and *Spirochaeta marchouzi*, 718.
 — — *savignyi*, and Tick fever, 712.
 Orszag's stain for spores, 147.
 Orth's carmine, 218.
 — alcohol carmine, 218.
 — picrocarmine, 218.
 Öse, 69.
 Osamic acid, fixation of films with, 205.
 "Osteomalacia" of horses, 792.
 Ovoid bacterium, 446.
 Oxen, Nagana in, 811.
 Oxycyanide of mercury, sterilization with, 26.
 Oxygen, action of, on anaerobes, 87.
 — tests for, 92.
 Padlewsky's method of isolating the typhoid bacillus, 411.
 Paget's disease of the nipple, 766.
 Pappenheim's stain, 220.
 Paracolon bacilli, 420.
 Para-dimethyl-amido-benzaldehyde test for indol, 374.
 Paraffin for sealing tubes, 30.
 — embedding, 212.
 — moulds, 214.
 — xylol mixture, 212.
Paramoecium coli, 830.
 Parasites in tumours, 766.
 — of Actinomycosis, 660.
 — Mycetoma, 665.
 Paratyphoid bacilli, 420.
 — — as cause of epizootics, 160.
 — A. bacillus, 423.
 — B. bacillus, 431.
 Paratubercle bacilli, 345.

- Paris vibrio, 491, 492.
 Park's egg medium for the tubercle bacillus, 317.
 Park and Williams' diphtheria bacillus, 257.
 — — toxin, 260.
 — method of neutralization, 31.
 Passive immunity, 222.
 Pasteur flasks, 29.
 — pipettes, 67.
 Pasteur's hot air sterilizer, 5.
 — method of cultivating anaërobes, 92.
 — examining air, 862, 865.
 — tube for cultivating anaërobes, 93.
 — septicæmia, 86, 561.
 — synthetic medium, 38.
 — vaccines for anthrax, 528.
 — wine medium, 38.
 Pasteur-Chamberland filter, 14.
 Pasteur, Joubert and Chamberland's tube for cultivating anaërobes, 93.
 Pasteurella group of bacilli, 446.
 — — compared with plague, 447, 464.
 — infections, vaccination against, 459.
Pasteurella bovis, 455.
 — *canis*, 457.
 — *capræ*, 456.
 — *cuniculi*, 453.
 — *equi*, 456.
 — *gallinæ*, 447.
 — *ovis*, 456.
 — *suæ*, 454.
 Pasturellosis, spontaneous, among laboratory animals, 160.
 — and plague in animals, 447.
 Pasteurization, 12, 45.
 Pastor's method of cultivating tubercle bacilli from sputum, 340.
 Pastilles of diphtheria antitoxin, 269.
 Pébrine, 752.
Pediculus capitis and Spirochætosis, 711.
 — — and Typhus, 848.
 — *vestimenti (corporis)* and Spirochætosis, 711.
 — — — and Typhus, 848.
 Pelikan Tusche, 83.
 Penetrating power of lenses, 113.
Penicillium, 700.
 — *crustaceum*, 700.
 — *glaucum*, 700.
 — *minimum*, 700.
 — *pictor*, 698.
 Peptone (*see also* Agar and gelatin culture media).
 — solution (Gordon's) for carbohydrate reactions, 600.
 — — (Koch's), 33.
 — — (Martin's), 32.
 — -beef-broth, 30.
 — -broth (Martin's), 33.
 — -gelatin medium (Metchnikoff's), 33.
 — -yeast extract, 37.
 Perochloride solution (Schaudinn's) as a fixative, 749.
 — — for sterilization, 26.
 Péré's method of isolating the typhoid bacillus, 402.
Perisporacidae, 694.
 Perlsucht, 294 footnote.
 Percutaneous reaction, 328.
 Pernicious anæmia of horses, 456.
 — malaria, 780.
 Pertussis, bacillus of, 511.
 Petri dish, 55.
 Petri's method of examining air, 865.
 — cholera toxin, 494.
 Petzval's condition for flatness of image, 115.
 Pfeiffer's cholera serum, 490.
 — influenza bacillus, 504.
 — phenomenon, 222, 227, 499.
 — warm stage, 135.
 Pfeiffer and Kolle's antityphoid vaccine, 381.
 Phagocytosis, 222.
 Pharyngeal exudates, collection of, 197.
 Pheasants, epizootics among (*Past. gallinæ*), 447.
 Phenol-phthalein as indicator, 31.
 Phisalix's collodion sacs, 176.
 — egg medium for the tubercle bacillus, 317.
 — vaccines for distemper, 458.
Phlebotomus and oriental sore, 802.
 Pian, 736.
 Pianese's fixative for coccidia, 761.
 Picrocarmine, Orth's, 218.
 Piedra, 670.
 Pigeon crammers' disease, 696.
 Pigeons and plague, 461.
 Pigeons, epizootics among (*Past. gallinæ*), 447.
 Pigs, Sarcosporidia in, 756.
 — Tuberculosis in, 295.
 — and plague, 461.
 — contagious pneumonia of, 454.
 Pigs' stomach broth, 32.
 Pigments of *B. pyocyaneus*, 279.
 Pincushion distortion, 109.
 Pinta, 698.
 Pipettes, bulb, 22.
 — Levaditi's, 234.
 — Pasteur, 67.
 — Roux, 92.
 — feeding experiments with, 181.
Piroplasma, 786.
 — *bigeminum*, 787.
 — *canis*, 791.
 — *equi*, 792.
 — *mulans*, 793.
 — *ovis*, 791.
 — *parvum*, 793 footnote.
 — *pitheci*, 793.
 von Pirquet's cuti-reaction in Tuberculosis, 327.
 Pitfield's flagellum stain, 152.
 Pithion and Roux's stain for tubercle bacilli, 309.
Pityriasis versicolor, 669.
 — — *alba*, 670.
 — — *flava*, 670.
 — — *nigra*, 670.

- Placenta as culture medium, 54.
 — -agar for Meningococcus (Kut-scher's), 647.
 — -broth for tubercle bacilli, 318.
- Plagiomonas irregularis*, 827.
 — *urinaria*, 827.
- Plague, bacillus, 460.
 — — differentiation from pasteurella bacilli, 447.
 — spontaneous, in rabbits (*post mortem* appearances), 454.
 — and swine plague, 454.
 — infection of rats by feeding, 464.
- Plasmodium*, 770.
 — *danilewskyi*, 782.
 — *malariae*, 770, 780.
 — *praecox*, 770, 780.
 — *relictum*, 782.
 — *vivax*, 770, 780.
 — *ziemanni*, 782.
- Plaster plates for filtering, 14.
- Plates Bombicci's, 101.
 — Kitasato's, 101.
 — Zinsser's, 102.
- Platinum wires, 69.
- Plato's stain (Gonococcus), 637.
- Pleural fluid, collection of, 198.
 — — as culture medium, 52.
- Pleuro-pneumonia contagiosa, virus of, 836.
- Pneumobacillus of Friedländer, 415.
- Pneumococcus, 580, 601.
 — medium for (blood broth), 34.
 — and influenza, 504.
- Pneumonia, gonococcal, 634.
 — spontaneous, in animals, 160.
- Pneumonic plague, 460, 462.
- Pneumo-enteritis of horses, 456.
- Pockenkrankheit, 756.
- Polychrome blue, Unna's, 139.
 — discomyces of Vallée, 669.
- Polyvalent antistreptococcal serum, 608.
- Pommelière, 294 footnote.
- Ponos, 800.
- Porous porcelain filters, 14.
- Porgès' serum diagnosis of syphilis, 741.
- Porgès and Meyer's diagnosis of syphilis, 740.
- Portal vein, inoculation into, 177.
- Porospora gigantea*, 796.
- Post mortem* examinations, 184.
 — — infections, Colon bacillus in, 393.
- Post partum* sepsis in cows, Gaertner bacillus in, 442.
- Potain's aspirator, 52.
- Potassium pyrogallate, 89.
- Potato bacillus, isolation of, 84.
 — medium, 37, 55.
 — — synthetic, 56.
 — — — (Remy and Sugg's), 372.
 — tube, 55.
- Pouchet and Bonjean's method of isolating the typhoid bacillus, 402.
- Pravaz's syringe, 166.
- Precipitins, 227.
- "Premier vaccin" of Pasteur (Anthrax), 528.
- Preventive strength and antitoxic strength (diphtheria antitoxin), 268.
- Primary agglutinins (*see* Agglutinins).
- Proca and Vasilescu's stain (*T. pallidum*), 729.
- Prophylactic serums, 223.
- Prophylaxis of tetanus, 546.
- Proteosoma*, 770.
 — of Labbé, 782.
- Proteus hominis capsulatus*, 571.
- Protozoic dermatitis, 706.
- Prurigo decalvana, 688.
- Pseudo-acid-fast bacilli, 346.
 — -actinomycosis, 665.
 — -alopecia, 692.
 — -diphtheria bacillus, 273.
 — -gaertner bacilli, 444.
 — -gonorrhœa, 634.
 — -influenza bacilli (Pfeiffer's), 510.
 — -miliary tuberculoes, 346.
 — -mucin, 639 footnote.
- Pseudonavicella*, 795.
- Pseudo-paratyphoid A. bacillus, 430.
 — -tuberculosis in experimental animals, 160.
 — — bacillus of, 160, 474.
 — -tuberculoes, 347.
- Psittacosis, 445.
- Psorospermiasis, 706.
- Psorospermiosis follicularis*, 766.
- Puerperal septicæmia, 592.
 — — serum treatment of, 607, 608.
- Pulex (Xenopsyllus) cheopis* and plague, 461.
 — -*irritans* and plague, 461.
 — -*murinus* (*X. cheopis*), 461.
 — -*pallidus* (*X. cheopis*), 461.
 — -*philippinensis* (*X. cheopis*), 461.
- Pulmonary anthrax, 517.
 — exudates, collection of, 198.
 — mycosis, 677.
 — rhizomucormycosis, 678.
- Pump, d'Alvergniat's, 90.
 — mercury, 90.
 — vacuum, 90.
 — water, 90.
- Puncture of spleen, 198.
- Pus, collection of, 197.
 — detection of tubercle bacilli in, 342.
- Pyæmia, 617.
- Pyocyanine, 279.
- Pyocyanolysin, 280.
- Pyogenic staphylococci, 617.
- Pyrosoma*, 786 footnote.
 — *bigeminum*, 787.
- Qualitative examination of water, 856.
- Quartan malarial fever, 780.
- Quarter ill, 552.
 — — vaccines (Arloing's), 556.
 — — — (Leclainche and Vallée's), 557, 558.
- Quotidian malarial fever, 780.
- Rabbits as experimental animals, 156.
 — bleeding of, 194.
 — epizootics among (Gaertner bacillus), 442.

- Rabbits, epizootics among (*Past. gallinæ*), 448.**
 — — — (*cuniculi*), 453.
 — — — (Plague bacillus), 460.
 — handling of, 161.
 — inoculation into the biliary passages of, 177.
 — intra-cranial inoculation of, 180.
 — intra-spinal — 181.
 — intra-venous — 172.
 — œsophageal catheterization of, 181.
Rabbit pasteurellosis, 453.
 — septicæmia, bacillus of, 453.
Rabbits, spontaneous trypanosomiasis of, 808.
 — — tuberculosis of, 295.
Rabies, virus of, 841.
 — simulated in dogs by infection with *B. pyocyaneus*, 276.
Ræbiger's stain for capsules, 148.
Rag-pickers' disease, 561.
Rainey's tubes, 757.
Raisin-gelatin, 41.
Ramond's agar, 397.
Ramsden eyepiece, 122 footnote.
Ranvier's hollow-ground slide, 134.
 — lamp, 118.
 — rat bit, 163.
 — warm stage for the microscope, 135.
Rats as experimental animals, 156.
 — handling of, 162, 163.
 — epizootics among (*B. guertner*), 442.
 — — — (*B. typhi murium*), 444.
 — — — (Leprosy), 348.
 — — — (Plague), 460.
 — — — — *Post mortem* appearances, 474.
 — spontaneous methæmoglobinæmia in, 442.
Rat louse and *Trypanosoma lewisi*, 805.
 — viruses, 445.
Raulin's culture medium, 38.
Ravaut's stain (*T. pallidum*), 728.
Ravaut and Ponselle's method of examining the blood (Syphilis), 733.
Razors, microtome, 211.
Re-activated bacteriolytic serum, 228.
Rectal injections, 182.
Red mycetoma, 665.
Red water of cattle, 787.
Reed sacs, 176.
Refractive index (cedar wood oil, etc.), 119.
Reitmann's stain (*T. pallidum*), 729.
Relapsing fever, 711.
Rémy's "differential gelatin" for the typhoid bacillus, 404.
Rémy and Sugg's stain for flagella, 150.
 — — synthetic medium, 375.
 — — — potato medium, 372.
Resolving power, 112.
Resolution with dark-ground illumination, 123.
Reservoirs of Sleeping sickness, 820, 821.
 — *Trypanosoma brucei*, 811.
Rheumatism, acute, 592.
 — bacillus (Achalme's), 569, 570.
 — gonorrhœal, 634.
Rhinosporidium kinealyi, 759.
Rhipicephalus appendiculatus and *Theileria parva*, 793.
 — bursa and *Piroplasma ovis*, 791.
 — decoloratus and *Spirochæta theileri*, 719.
 — evertsi and *Piroplasma equi*, 792.
 — sanguineus and *Piroplasma canis*, 791.
 — simus and *Theileria parva*, 793.
Rhizomucor parasiticus, 678.
Rhizopoda, 745.
Rhizopus cohni, 678.
 — equini, 678.
 — niger, 678.
 — nigricans, 678.
Rhodesian fever of cattle, 793.
Ribbert's stain (Pneumococcus), 584.
Rice milk culture medium, 56.
Rinderpest, virus of, 839.
Ring parasite of malaria, 774.
Ringworm, 679.
 — in cats, 687.
 — dogs, 687, 688.
 — fowls, 687.
 — horses, 687.
Rocking microtome, 211.
Rocky Mountains fever, 802.
Rodet's method of isolating the typhoid bacillus, 402.
Rodents, Trypanosomes in, 808.
Rohrbeck's temperature regulator, 59.
Roll tube, Esmarch's, 81.
Romanowsky blood stain, 210.
Roosen-Runge's method of isolating the typhoid bacillus, 392.
Rosenthal's antidyentery serum, 362.
Rosenbach's *Streptococcus pyogenes*, 593, 596.
Rosenbach's stain (*T. cruzi*), 822.
Rosette parasite of malaria, 775.
Ross' method of blood examination (malaria), 772.
de Rossi's stain for flagella, 157.
Rost's medium for leprosy, 352.
Roth's method of isolating the typhoid bacillus, 409.
Rothe's serum-broth medium, 274.
Rougeole, 283 footnote.
Rouget du porc, 283 footnote.
Roux bottle, 78.
Roux's blue, 140.
 — carbol-crystal-violet, 138.
 — gelatin, 40.
 — incubator, 65.
 — pipette for cultivating anaërobes, 92, 99.
 — potato tube, 55.
 — syringe, 167.
 — temperature regulator, 60.
 — tube for cultivating anaërobes, 100, 101.
 — — isolating anaërobes, 103.
 — standardization of diptheria anti-toxin, 268.
Roux, Metchnikoff and Salimbeni's cholera toxin, 495.

- Roux and Martin's diphtheria toxin, 258.
 Roux and Nocard's method of preparing serum, 48.
 — — reed sacs, 176.
 Rowland's plague toxin, 467.
 — — serum, 472.
 Royal Commission on Tuberculosis, 290 *et seq.*
 Ruediger's ascitic agar (Pneumococcus), 585.
 Ruffer's method for demonstrating parasites in cancer, 768.
- Saathoff's differential stain for sections, 220.
 Sabouraud's glucose-agar (*Sporotricha*), 673.
 — glycerin-agar (*Achorion schaeleinii*), 692.
 — proof agar (*Tricophyta*), 681.
 — agar (*Tricophyta*), 681.
 Sacs, collodion, 174.
 — reed, 176.
- Saccharomyces*, 701 footnote.
 — *albicans*, 702.
 — *anginae*, 705.
 — *ellipsoideus*, 706.
 — *granulatus*, 706.
 — *guttulatus*, 706.
 — *lithogenes*, 706.
 — *membranogenes*, 706.
 — *neoformans*, 707.
 — *roseus*, 706.
 — *tumefaciens*, 704.
 — and Cancer, 707.
- Saccharomycetidae*, 701.
 Saccharomycosis, 706.
 Sahli's borax blue, 681.
 Salkowski's reaction for indol, 374.
 Salmonella group of bacilli, 422, 431.
 — and plague, 473.
 Salomonsen's agar, 44.
 Sanarelli's typhoid toxin, 377.
 Sand as a triturating agent, 170.
 Sand flies and Oriental sore, 802.
 Sanfelice's antianthrax serum, 532.
 Sarcocoele in glands, 481.
 Sarcocystine, 758.
Sarcocystis blanchardi, 758.
 — *immitis*, 756, 758.
 — *miescheriana*, 758.
 — *muris*, 756, 758.
 — *tenella*, 756, 758.
- Sarcosporidia*, 756.
 Sarcosporosis in man, 756.
 — pigs, 757.
 — rats, 758.
 — sheep, 756.
- Saturation of agglutinins, 436.
 Savage's neutral red media, 411.
 Scarlet fever and streptococci, 592, 596, 607.
 Schaudinn's classification of *Trypanosomidae*, 804.
 — fixative, 749.
 — stain (*T. pallidum*), 730.
Schizotrypanum cruzi, 822.
 Schmitz, Turró and Blell's cholera toxin, 495.
 — — — — vaccine, 497.
- Schottmüller's classification of Streptococci, 599.
 Schueder's method of isolating the typhoid bacillus, 406.
 Schüffner's dots, 773, 780.
 Schwein Rothlauf, 283 footnote.
 Schweinepest, 438, 454 footnote.
 Schweineseuche, 454.
 Slavo's stain for flagella, 153.
 — antianthrax serum, 532.
Schlerothrix kochi, 289, 661.
 Seborrhoea oleosa, 692.
 Secondary agglutinins (*see* Co-agglutinins).
 "Second vaccin" of Pasteur (Anthrax), 528.
 Sections, histological, 211.
 — fixation of, 215.
 — staining of (simple), 216.
 — — (differential), 217.
 — — — gram negative organisms, 220.
 — — (triple), 219.
- Section lifter, 215.
 Sensibilisatrice, 228.
 Sensitized vaccines (Besredka's) in Dysentery, 362.
 — — — Enteric fever, 383.
 — — — Plague, 470.
 — — — Streptococcal infections, 605.
- Septicæmia, Pasteur's, 86, 561, 563.
 — spontaneous, in animals, 159.
 Serous exudates, examination of (Tubercle bacilli), 342.
- Serum, ascitic fluid, 52.
 — blood, 36.
 — coagulation of, 51.
 — collection of, 45, 196.
 — glycerin, 53.
 — Loeffler's, 52.
 — pleural fluid, 52.
 — -agar, 53.
 — — (Bordet and Gengou), 511.
 — — (Tochtermann's), 53.
 — -broth, 34.
- Serums, agglutinating, 225.
 — antitoxic, 224.
 — bactericidal, 227.
 — hæmolytic, 230.
 — prophylactic, 223.
 — therapeutic, 223.
- Serum diagnosis (*see* the several chapter headings), 225.
 — therapy (*see* the several chapter headings), 225.
- Sewage, bacteriological examination of, 861.
 Shanghai vibrio, 492.
 Sharpening of razors, 211.
 Sheep pasteurellosis, 456.
 — piroplasmosis, 791.
 — and plague, 461.
 — sarcosporidiosis, 756.
 — spirochæstosis, 719.
 — Tuberculosis in, 295.
 — -pox, Virus of, 839.
 — cell, 840.
- Shiga's antidyserentary serum, 362.
 — — vaccine, 362.
 — antiplague vaccine, 470.

- Shiga-Krüse dysentery bacillus, 357.
 Siberian fever of horses (Anthrax), 578.
 Silk, preparation of sterile, 165.
 Simonelli and Bandi's stain (*T. pallidum*), 729.
 Simple continued fever in India, 423.
 — staining solutions, 137.
 — — of films, 205.
Simulium (Genus), 699.
 Sine condition for aplanatism, 110.
 Sivori's trocar, 48, 49.
 Skin, removal of, for bacteriological examination, 191.
 Slatineano's influenza toxin, 508.
 Slides, cleaning of microscope, 130.
 Sleeping Sickness, 816.
 Smear preparations, 203.
 Smegma bacillus, 346.
 Solid substances, inoculation of, 169.
 Sobernheim's antianthrax serum, 532.
 Soft sore and syphilis, 576.
 Solid media, 39.
 Sowing of cultures, 67.
 Souma, 814.
 Soudakewitch's method for demonstrating parasites in cancers, 767.
 Spatula, 215.
 — (Drigalski's), 407.
 Specific agglutinins (*see* Agglutinins).
 Spengler's method for cultivating tubercle bacilli from sputum, 341.
 — stain (Tubercle bacilli), 309.
 Spherical aberration, 110.
Spirillum nigrum, 577.
Spirilla, 356.
Spirochæta (Genus), 804.
 — *anserina*, 717.
 — *balanitidis*, 734.
 — *buccalis*, 735.
 — *carteri*, 712.
 — *dentium*, 735.
 — *duttoni*, 712.
 — *gallinæ*, 718.
 — *kochi*, 712.
 — *lawenthalii*, 736.
 — *marchouxii*, 718.
 — *media*, 735.
 — *microgirata*, 736.
 — *neveuzyi*, 718.
 — *nicolei*, 718.
 — *novyi*, 712.
 — *obermeyeri*, 712.
 — *pallida*, 720.
 — *pertenusii*, 736.
 — *plicatilis*, 735.
 — *recurrentis*, 712.
 — *refringens*, 734.
 — *rossii*, 712.
 — *theileri*, 719.
 — *vincentii*, 735.
 Spirochætes of malignant ulcers, 735.
 Spirochætosus, 711.
Spironema, 720.
 Splenectomy, 199.
 Splenic apoplexy, 517.
 — fever, 517.
 — puncture, 198.
 Spontaneous diseases of experimental animals, 159.
 Sporadic dysentery, 356.
 Spores, 145.
 — resistance to heat, 7.
 — staining of, 146.
 Spore-bearing organisms, isolation of, 84.
 Sporo-agglutination (Sporotrichosis), 674.
 Sporotrichosis, 672.
Sporotrichum beurmanni, 672.
 — *dori*, 672.
 — *schenkii*, 672.
 Sprengler's method of examining sputum (Tubercle bacilli), 339.
 Spronck's medium for diphtheria toxin, 257.
 — yeast extract, 37.
 Sputum, collection of, 191.
 — homogenization of, 339.
 Squirrels, Trypanosomes in, 808.
 Stab cultures, sowing of, 72.
 — characters of, 74.
 Stage, Koch's drying, 141.
 Stains for micro-organisms, 136.
 — aniline fuchsin, 483.
 — carbol-fuchsin-methylene-blue (Queyrat), 514.
 — cresoidin, 253.
 Staining of blood films, 207.
 — capsules, 147.
 — film preparations, 140, 205.
 — flagella, 148.
 — living organisms, 140.
 — sections, 216.
 — spores, 146.
 Stalactites in plague, 465, 473.
 Standardization of antitoxin (diphtheria), 267.
 — (tetanus), 545.
 — antityphoid vaccine, 381.
Staphylococci pyogenes, 617.
Staphylococcus cutis communis, 693.
 — *parvulus*, 578.
 — *pyogenes albus*, 617, 620.
 — *aureus*, 617, 619.
 — *citreus*, 617, 620.
 Staphylolysin, 623.
 Starch jelly, 56.
 Stassano's apparatus for collecting blood, 196.
 Steam, sterilization in, 7, 9.
 Steamers, 8.
Stegomyia fasciata, *Nosema* in, 754.
 — and yellow fever, 841.
 Stephens' stain for flagella, 153.
 Sterilizers, hot air, 5.
 Sterilization, definition of, 3.
 — by antiseptics, 26.
 — discontinuous heating, 8, 12.
 — dry heat, 4.
 — filtration, 14.
 — moist heat, 7.
 Stern's stain (*T. pallidum*), 728.
Sterigmatocystis, 699.
 — *nidulans*, 665, 699.
 — *nigra*, 699.
Stomoxys and Surra, 814.

- Stomoxys calcitrans* and anterior poliomyelitis, 846.
- Stools, collection of, for bacteriological examination, 202.
- Strangles, 611.
- Straus' stain for flagella, 148.
- "sign" in glanders, 487.
- syringe, 166.
- Straus and Wurtz's method for examination of air, 866.
- Straw infusion, 37.
- Steinschneider's agar for Gonococcus, 640.
- Streptococci hominis*, 593.
- *animalium*, 611.
- classification of (Andrews and Horder), 601.
- varieties of, 593.
- Streptococcus* of Bonome, 610.
- *anginosus*, 601.
- *brevis*, 593, 596.
- *conglomeratus*, 596.
- *equi*, 611.
- *equinus*, 601.
- *erysipelatos*, 593, 596, 599.
- *faecalis*, 601.
- *longus*, 593, 596.
- *meningitidis*, 610.
- *mammitis bovis*, 613.
- *mitior*, 599.
- *mitis*, 601.
- *mucosus*, 599.
- *pyogenes*, 593, 599, 601.
- *salivarius*, 601.
- *tenuis*, 593, 596.
- *viridans*, 599.
- Streptocolyzin*, 603.
- Streptothrix* (see *Discomyces*), 655.
- pleomorphic, in leprosy, 351.
- *actinomyces*, 656.
- *asteroides*, 662.
- *caprae*, 668.
- *farcinica*, 667.
- *förstersi*, 662.
- *freeri*, 664.
- *israeli*, 661.
- *leproides*, 348.
- *maduræ*, 662.
- *rosenbachi*, 662.
- *spitzi*, 661.
- Streptothricine, 660.
- "Strict" anaerobes, 87.
- Strong's cholera vaccine, 498.
- dysentery bacillus, 360.
- Stroke cultures, method of sowing, 71.
- — isolation by, 81.
- Sub-cutaneous inoculation, 171.
- Surra, 814.
- Susceptibility of animals to experimental inoculation, 156.
- Swans, pasteurellosis in, 452.
- Swine erysipelas, bacillus of, 283.
- fever, virus of, 843.
- pasteurellosis, 454.
- plague, bacillus of, 454.
- tuberculosis, 295.
- typhoid, 454 footnote.
- Sycosis, 686.
- Symptomatic anthrax (see Quarter ill), 552.
- Synthetic media, 38.
- medium (Rémy and Sugg's), 372.
- Syphilis, 720.
- bacillus of Lustgarten, 306 footnote, 346.
- Syringes for inoculation, 166.
- Syringospora robini*, 702.
- Tabanus* and Surra, 814.
- Tannin solution (Nicolle's), 210, 217.
- Tarbagan and Plague, 462.
- Tarozzi's method of cultivating anaerobes, 98.
- — isolating anaerobes, 102.
- "Tarse favique," 691.
- Tavel, bacillus of, 306 footnote.
- Tavel's antistreptococcus serum, 609.
- stain (Tubercle bacilli), 306.
- "Teigne tondante" of Gruby, 688.
- — rebelle," 688.
- Telosporidia*, 760.
- Temperature of cattle, 182 footnote.
- regulators, 59.
- Terni and Bandi's Plague vaccine, 469.
- Tertian fever, 780.
- Tests for indol, 374.
- oxygen, 92.
- Tetanolysin, 544.
- Tetanus bacillus, 536.
- antitoxin, 545.
- prophylaxis, 546.
- Texas fever, 787.
- Theileria parva*, 793.
- Therapeutic serums, 223.
- Thesing's stain for spores, 147.
- Thrush, 702.
- Thymol as an antiseptic, 26.
- Thymus broth, 34.
- Tick fever, 712.
- Ticks and *Piroplasmata*, 786 *et seq.*
- and kala azar, 800.
- and Rocky Mountains fever, 802.
- Timothee bazillus, 345.
- Tinea barbae*, 679.
- *circinata*, 679.
- — *dysidrosiforme*, 687.
- *cruris*, 688.
- *imbricata*, 687, 700.
- *kerion*, 686.
- *marginata*, 688.
- *rosea*, 670.
- *sycosis*, 679.
- *tonsurans*, 679.
- *versicolor*, 669.
- Tissues, bacteriological examination of, 203.
- as culture media (Tubercle bacilli), 318.
- Titre of agglutination, measurement of, 388.
- Tochtermann's agar, 317.
- serum-agar, 53.
- Tokelau, 700.
- Toluene method of embedding, 215.
- Toluol as an antiseptic, 27.
- Tonsil, puncture of, 197.
- Tortoises, tuberculosis in, 297.
- Toxicity and virulence, 257 footnote.

- Toxin (*see* the several chapter headings).
 — unit of, 260.
- Trachea, inoculation into, 179.
- Tray for sloping culture media, 52.
- Trenkman's stain for flagella, 151.
- Treponema* (Genus), 804.
 — *pallidum*, 720.
 — *pallidulum*, 736.
- Tretröp's vacuum apparatus for cultivating anaërobes.
- Trichomonas*, 356.
 — *batracorum*, 827.
 — *cavice*, 827.
 — *intestinalis*, 825.
 — *vaginalis*, 825.
- Trichosporosis, 670.
- Trichosporum*, 670.
 — *beigeli*, 671.
 — *foxi*, 671.
 — *giganteum*, 671.
 — *krusi*, 671.
 — *ovale*, 671.
 — *ovoides*, 671.
- Tricophyton*, 679.
 — *acuminatum*, 684.
 — *asteroides*, 685.
 — *caninum*, 687.
 — *concentricum*, 687.
 — *crateriforme*, 682.
 — *ectothrix*, 686.
 — — *megaspores*, 682.
 — — *microides*, 682.
 — *endothrix*, 682.
 — *endo-ectothrix*, 682, 685.
 — *equinum*, 687.
 — *faviforme*, 687.
 — *felineum*, 687.
 — *fragile mycelium*, 684.
 — *gypseum*, 682, 685.
 — *mansonii*, 687.
 — *magnini*, 687.
 — *megalosporum endothrix*, 682.
 — *mentagrophytes*, 685.
 — *microsporium*, 688.
 — *niveum*, 682, 687.
 — *pictor*, 698.
 — *pyogenes*, 686.
 — *radicans*, 687.
 — *resistant mycelium*, 683.
 — *sabouraudi*, 684.
 — *sulphureum*, 685.
 — *tonsurans*, 682.
 — *violaceum*, 685.
- Triple staining of sections, 219.
- Tristeza, 787.
- Tse-tse fly disease, 811.
 — flies and Nagana, 811.
 — — and Sleeping Sickness, 820.
- Trocar, Nocard's, 48.
 — Sivori's, 48.
- Tropical malarial fever, 780.
 — piroplasmiasis of cattle, 793.
- Trout, disease of, 756.
- Trypanoplasma* (Genus), 804.
- Trypanosoma* (Genus), 804.
 — *abramis*, 825.
 — *avium*, 823.
- Trypanosoma brucei*, 811.
 — *cazalboui*, 814.
 — *congolense*, 813.
 — *cruzi*, 822.
 — *danilewskyi*, 825.
 — *dímorphon*, 813.
 — *equinum*, 814.
 — *equiperdum*, 809.
 — *evansi*, 814.
 — *gambiense*, 816.
 — *lewisi*, 805.
 — *pecaudi*, 814.
 — *rajæ*, 825.
 — *remaki*, 825.
 — *rhodesiense*, 820.
 — *rotatorium*, 824.
 — *rougeti*, 809.
 — *sanguinis*, 824.
 — *soleæ*, 825.
 — *soudanense*, 813.
 — *theileri*, 816.
 — *ugandense*, 816.
- Trypanosomata*, 802.
- Trypanosome fever, 816.
 — of Dourine, 809.
 — — Galzietke, 816.
 — — Mal de Caderas, 814.
 — — Nagana, 811.
 — — Surra, 814.
- Trypanosomes of Sleeping Sickness, 816.
 — in birds, 823.
 — — cold-blooded vertebrata, 824.
 — — fish, 824.
 — — frogs, 824.
- Tube, Buchner's, for cultivating anaërobes, 95.
 — Esmarch's, for isolating anaërobes, 103.
 — Turró's, for cultivating anaërobes, 95.
 — Vignal's, for isolating anaërobes, 103.
- Tubercle bacillus, 289.
 — avian, 291.
 — bovine, 289.
 — human, 289.
 — ichthic, 292.
 — differentiation of types by cultivation, 320.
- Tuberculin, 324.
 — test, 325.
 — — in man, 326.
- Tuberculosis, Royal Commission on, 290 *et seq.*
- Tumours, removal of, for bacteriological examination, 198.
 — and Coccidia, 766.
- Turkeys, Pasteurellosis in, 447.
 — and plague, 461.
- Turró's tube for cultivating anaërobes, 95.
 — method of isolating anaërobes, 101.
 — gelatin medium for *Gonococcus*, 638.
- Twort's medium (*Leprosy bacillus*), 352.
- Tyndallization, 45.
- Typhoid bacillus, 366.
 — carriers, 367.
- Typholysin, 379.
- Typhus diagnosticum*, Ficker's, 388.
- Typhus fever, virus of, 847.

- Udder-broth (*Micrococcus neoformans*), 769.
 Ultra-microscope, 123.
 Ultra-microscopic viruses, 835.
 Undulant fever, 475.
Undulina ranarum, 824.
 Unit of antitoxin, 268.
 — measurement for microscopical objects, 122.
 — toxin, 260.
 Unna's polychrome blue, 139.
 Ureter, inoculation into, 178.
 Urethral inflammations, 634.
 Urinary bacillus of Clado, 393.
 Urine as culture medium, 36.
 — — — (Gonococcus), 638.
 — collection of sterile, 201.
 Utschinsky's medium for diphtheria toxin, 39.

 Vaccination (see the several chapter headings).
 Vaccines, Wright's, 605, 623.
 — Besredka's "sensitized," 362, 383, 470, 605.
 Vacuum incubators, 104.
 — pump, 90.
 Vaillard and Dopter's antidysentery serum, 362.
 Vallée's method of immunizing cattle against Tuberculosis, 332.
 Vallet's method of isolating the typhoid bacillus, 406.
 Varieties of the dysentery bacillus, 357.
 — streptococci, 593.
 — the tubercle bacillus, 290.
Variola ovina, 839.
 — *vaccinia*, 840.
 Vasilescu's homogeneous cultures of tubercle bacilli, 336.
 Veal broth, 32.
 Vegetable media, 37, 55.
 Veillon's method of isolating aërobes, 82.
 — — — anaërobes, 103.
 — *Streptococcus tenuis*, 596.
 Verruga peruana. bacillus of, 346.
 Versailles vibrio, 490.
 Vesuvius, aqueous solution of, 208, 218.
 Viability of micro-organisms (see the several chapter headings).
Vibrio cholerae asiatica, 488.
 Vibrio of Deneke, 503.
 — Finkler-Prior, 502.
Vibrio metchnikowi, 503.
 Vibron avicide, 503.
 — septique, 561.
 Vignal's tube for isolating anaërobes, 103.
 — warm stage, 135.
 Villemin type of experimental tuberculosis, 298, 300.
 Vincent's angina, 574, 575.
 — method of isolating the typhoid bacillus, 85, 402.
 — — examining stools for amœbæ, 748.
 — stain for blood films, 207.
 — — (*Bacillus fusiformis*), 576.
 Vincent and Bellot's reaction, 650.

 Violet, Nastikow's, 139.
 Virulence of micro-organisms (see the several chapter headings).
 — and toxicity, 257 footnote.
 Vitality of micro-organisms (see the several chapter headings).
 — phagocyted bacteria, 222.

 Wahl's stain (Gonococcus), 637.
 Warm stage for microscope, 135.
 Wassermann's antityphoid vaccination, 382.
 — reaction in Syphilis, 737.
 Water, bacteriological examination of, 851.
 — filtration of, 15.
 — baths, 12.
 — pump, 90.
 Weeks and Morax's bacillus, 510.
 Weigert's solution, 143.
 — stain for sections, 216.
 Weil's culture medium (Leprosy), 353.
 Werbitzki's medium for isolating the typhoid bacillus, 410.
 Werner's typhoid toxin, 378.
 Wertheim's agar (Gonococcus), 638.
 West African relapsing fever, 713.
 Weyl-Legal's test for indol, 374.
 White mycetoma, 665.
 Whooping cough, bacillus of, 511.
 Wild and Rinderseuche, 455.
 Wildbolz's agar (Gonococcus), 639.
 Windelbandt's method of isolating the typhoid bacillus, 412.
 Wine as a culture medium, 38.
 Woolsorter's disease, 517.
 Wright's capsule for collecting blood, 192.
 Wright's vaccines, 605, 623.
 Wright and Leishman's antityphoid vaccination, 381.

Xenopsyllus cheopis, 461.
 Xerosis bacillus, 245 footnote.
 Xylol method of embedding, 212.

 Y bacillus (dysentery), 360.
 Yaws, 736.
 Yeasts, 701.
 Yeast extract medium (Spronck's), 37.
 Yellow fever, 754, 841.
 — and *Bacillus icteroides*, 445.
 Yersin's gelatin-broth (Plague), 465.
 — plague serum, 471.
 Yersin type of experimental tuberculosis, 301.

 Zabolotny's stain (*T. pallidum*), 729.
 Zeidler's method of isolating the typhoid bacillus from blood, 391.
 Zeihl's carbol-fuchsin, 138.
 Zeihl-Neelsen's stain (Tubercle bacilli), 307, 310.
 Zinsser's method of isolating anaërobes, 102.
 Zooglic pseudo-tuberculozes, 347.
 Zygosporoz, 675.
Zymonema, 701 footnote.
 — *gilchristi*, 706.

